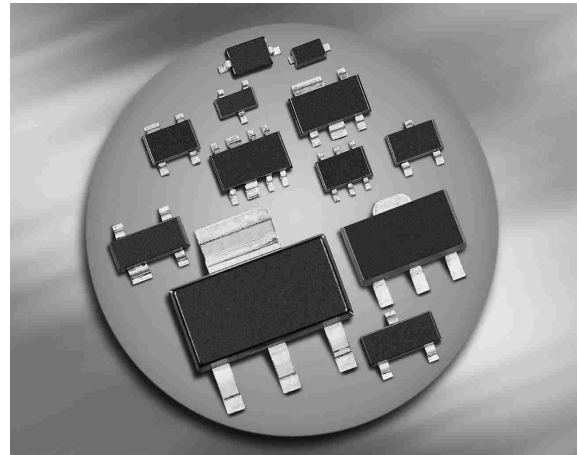
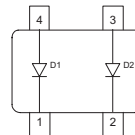
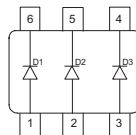
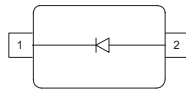

Silicon Switching Diode

- For high-speed switching applications
- Pb-free (RoHS compliant) package ¹⁾
- Qualified according AEC Q101

BAS16
BAS16W
BAS16-02L
BAS16-02V
BAS16-02W
BAS16-03W
BAS16S
BAS16U
BAS16-07L4

| Type | Package | Configuration | Marking |
|-------------|----------|-------------------------|---------|
| BAS16 | SOT23 | single | A6s |
| BAS16-02L* | TSLP-2-1 | single, leadless | A6 |
| BAS16-02V | SC79 | single | 6 |
| BAS16-02W | SCD80 | single | A6 |
| BAS16-03W | SOD323 | single | white B |
| BAS16-07L4* | TSLP-4-4 | parallel pair, leadless | 6A |
| BAS16S | SOT363 | parallel triple | A6s |
| BAS16U | SC74 | parallel triple | A6s |
| BAS16W | SOT323 | single | A6s |

* Preliminary Data

¹Pb-containing package may be available upon special request

Maximum Ratings at $T_A = 25\text{ °C}$, unless otherwise specified

| Parameter | Symbol | Value | Unit |
|---|-----------|-------------|------|
| Diode reverse voltage | V_R | 80 | V |
| Peak reverse voltage | V_{RM} | 85 | |
| Forward current | I_F | | mA |
| BAS16 | | 250 | |
| BAS16-02L, -07L4 | | 200 | |
| BAS16-02V, -02W | | 200 | |
| BAS16-03W | | 250 | |
| BAS16S | | 200 | |
| BAS16U | | 200 | |
| BAS16W | | 250 | |
| Non-repetitive peak surge forward current | I_{FSM} | | A |
| $t = 1\ \mu\text{s}$, BAS16/ S/ U/ W/ -03W | | 4.5 | |
| $t = 1\ \mu\text{s}$, BAS16-02L/ -02V/ -02W/ -07L4 | | 2.5 | |
| $t = 1\ \text{s}$ | | 0.5 | |
| Total power dissipation | P_{tot} | | mW |
| BAS16, $T_S \leq 54\text{ °C}$ | | 370 | |
| BAS16-02L, -07L4, $T_S \leq 130\text{ °C}$ | | 250 | |
| BAS16-02V, -02W, $T_S \leq 120\text{ °C}$ | | 250 | |
| BAS16-03W, $T_S \leq 116\text{ °C}$ | | 250 | |
| BAS16S, $T_S \leq 85\text{ °C}$ | | 250 | |
| BAS16U, $T_S \leq 113\text{ °C}$ | | 250 | |
| BAS16W, $T_S \leq 119\text{ °C}$ | | 250 | |
| Junction temperature | T_j | 150 | °C |
| Storage temperature | T_{stg} | -65 ... 150 | |

Thermal Resistance

| Parameter | Symbol | Value | Unit |
|--|------------|-------|------|
| Junction - soldering point ¹⁾ | R_{thJS} | | K/W |
| BAS16, BAS16S | | ≤ 260 | |
| BAS16-02L, -07L4 | | ≤ 80 | |
| BAS16-02V, -02W | | ≤ 120 | |
| BAS16-03W | | ≤ 135 | |
| BAS16U | | ≤ 150 | |
| BAS16W | | ≤ 125 | |

Electrical Characteristics at $T_A = 25^\circ\text{C}$, unless otherwise specified

| Parameter | Symbol | Values | | | Unit |
|---|------------|--------|------|------------------------------------|---------------|
| | | min. | typ. | max. | |
| DC Characteristics | | | | | |
| Breakdown voltage $I_{(BR)} = 100 \mu\text{A}$ | $V_{(BR)}$ | 85 | - | - | V |
| Reverse current $V_R = 75 \text{ V}$ $V_R = 25 \text{ V}, T_A = 150^\circ\text{C}$ $V_R = 75 \text{ V}, T_A = 150^\circ\text{C}$ | I_R | - | - | 1 30 50 | μA |
| Forward voltage $I_F = 1 \text{ mA}$ $I_F = 10 \text{ mA}$ $I_F = 50 \text{ mA}$ $I_F = 100 \text{ mA}$ $I_F = 150 \text{ mA}$ | V_F | - | - | 715 855 1000 1200 1250 | mV |
| Forward recovery voltage $I_F = 10 \text{ mA}, t_P = 20 \text{ ns}$ | V_{fr} | - | - | 1.75 | V |

¹⁾For calculation of R_{thJA} please refer to Application Note Thermal Resistance

Electrical Characteristics at $T_A = 25^\circ\text{C}$, unless otherwise specified

| Parameter | Symbol | Values | | | Unit |
|---|----------|--------|------|------|------|
| | | min. | typ. | max. | |
| AC Characteristics | | | | | |
| Diode capacitance $V_R = 0\text{ V}$, $f = 1\text{ MHz}$ | C_T | - | - | 2 | pF |
| Reverse recovery time $I_F = 10\text{ mA}$, $I_R = 10\text{ mA}$, measured at $I_R = 1\text{ mA}$, $R_L = 100\ \Omega$ | t_{rr} | - | - | 4 | ns |

Test circuit for reverse recovery time

Pulse generator: $t_p = 100\text{ ns}$, $D = 0.05$, $t_r = 0.6\text{ ns}$,
 $R_i = 50\ \Omega$

Oscilloscope: $R = 50\ \Omega$, $t_r = 0.35\text{ ns}$, $C = 0.05\text{ pF}$

Reverse current $I_R = f(T_A)$

$V_R =$ Parameter

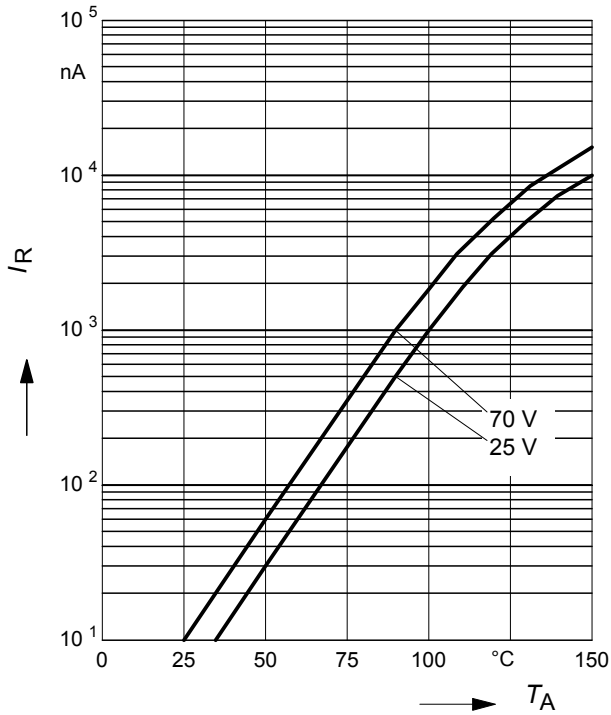

Forward Voltage $V_F = f(T_A)$

$I_F =$ Parameter

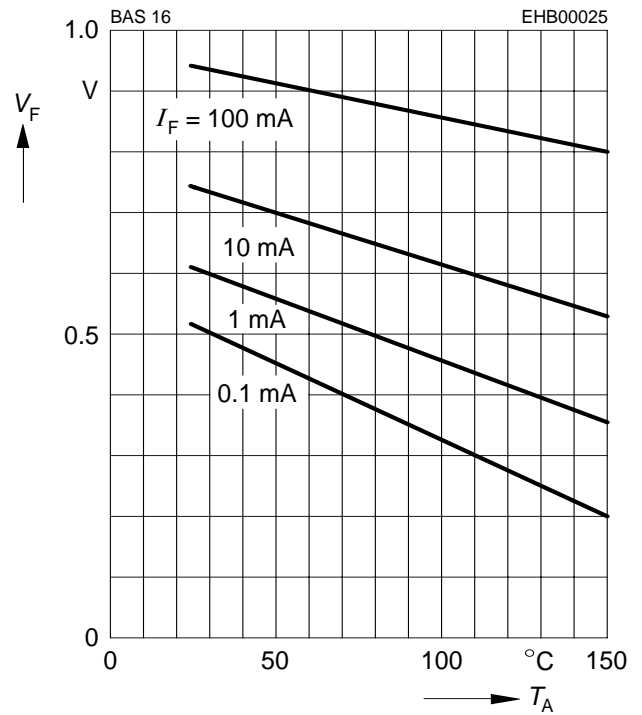

Forward current $I_F = f(V_F)$

$T_A = 25^\circ\text{C}$

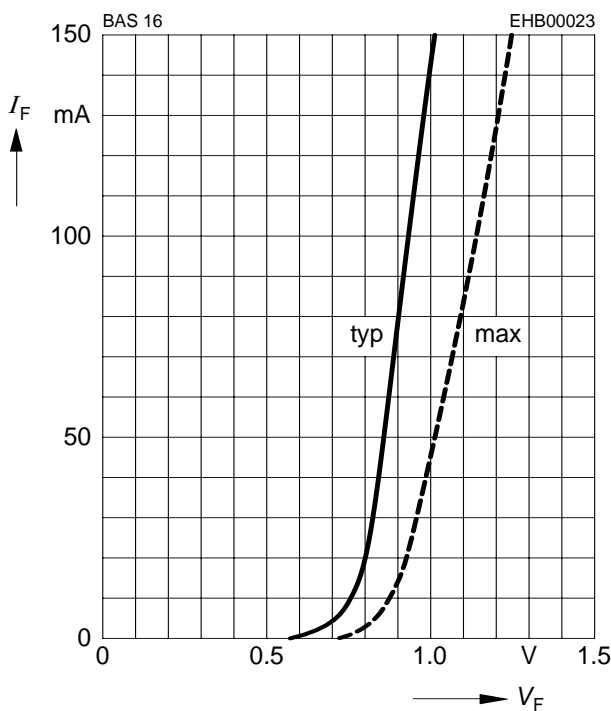

Forward current $I_F = f(T_S)$

BAS16

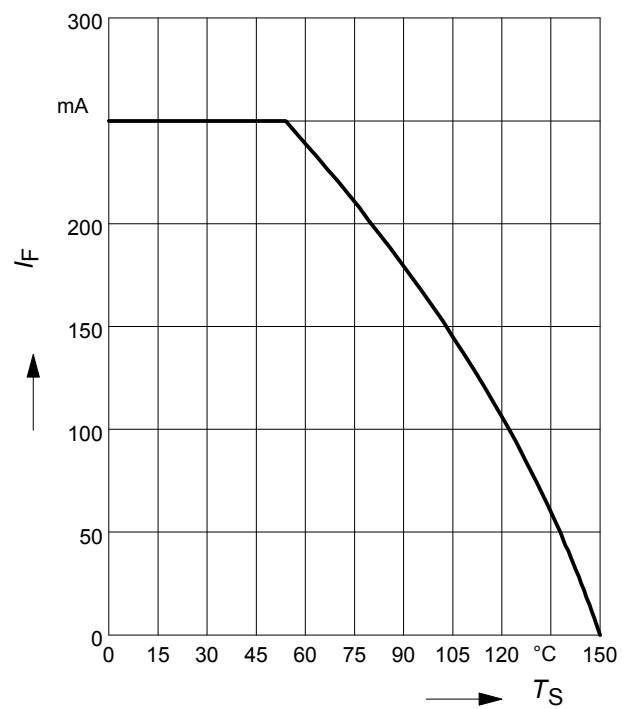

Forward current $I_F = f(T_S)$

BAS16-02L, -07L4

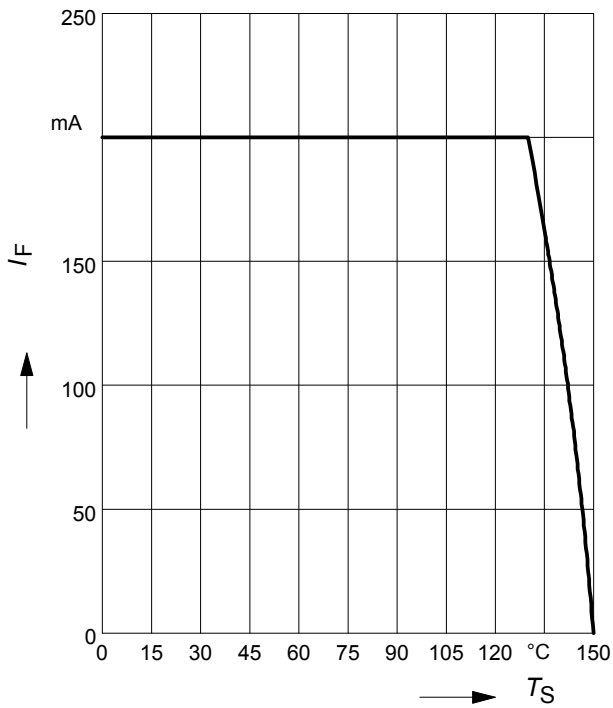

Forward current $I_F = f(T_S)$

BAS16-02V, -02W

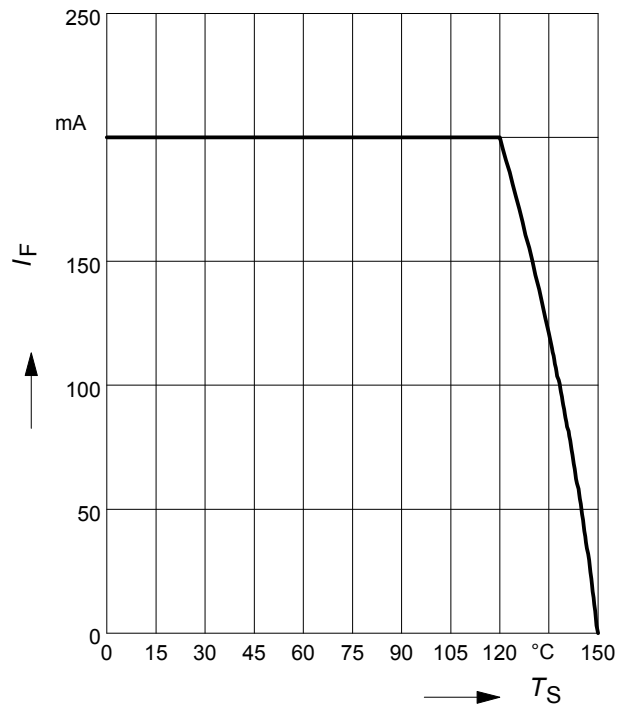

Forward current $I_F = f(T_S)$

BAS16-03W

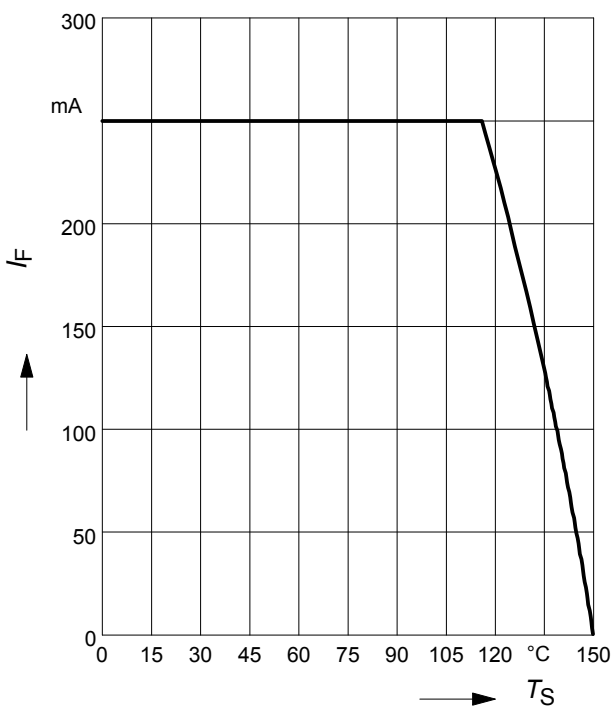

Forward current $I_F = f(T_S)$

BAS16S

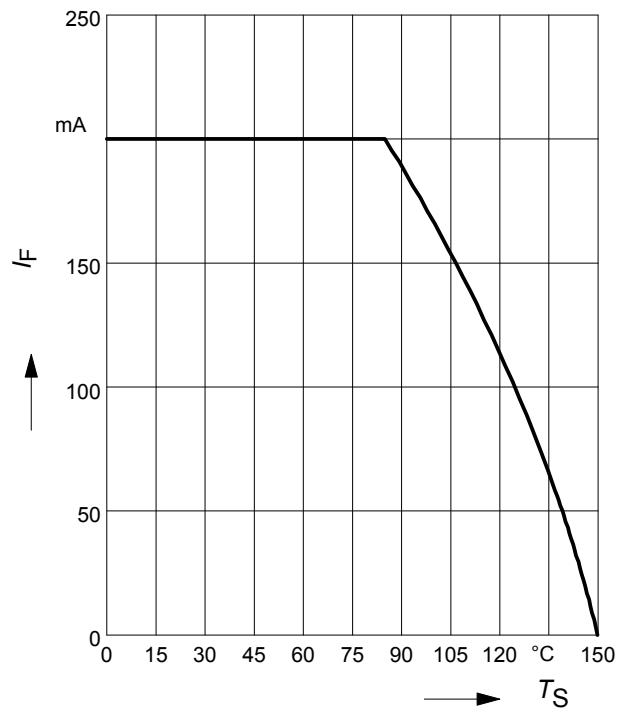

Forward current $I_F = f(T_S)$

BAS16U

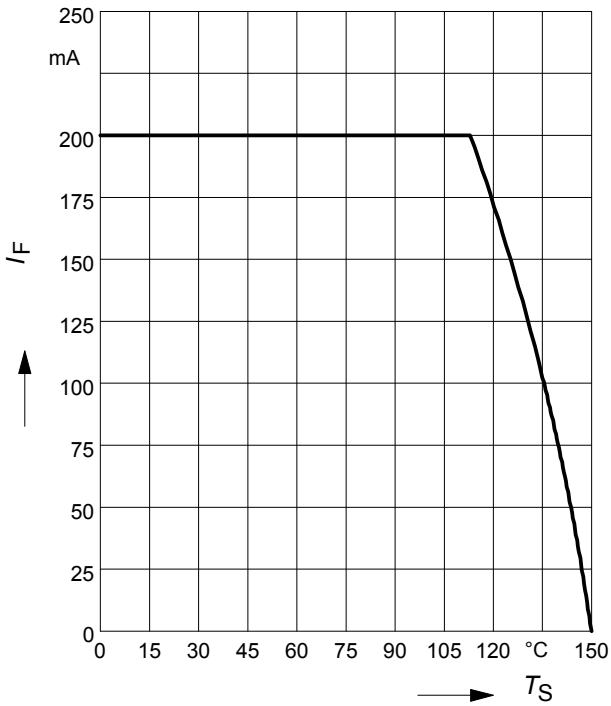

Forward current $I_F = f(T_S)$

BAS16W

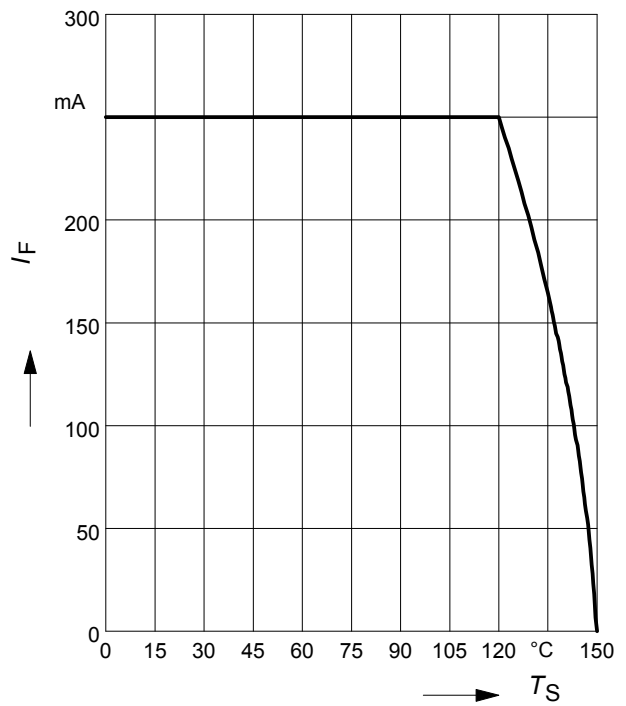

Permissible Puls Load $R_{thJS} = f(t_p)$

BAS16

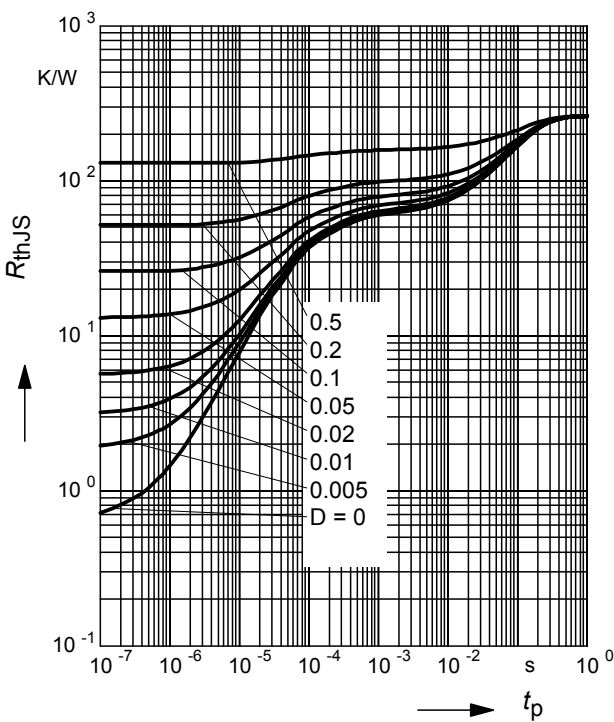

Permissible Pulse Load

$I_{Fmax} / I_{FDC} = f(t_p)$

BAS16

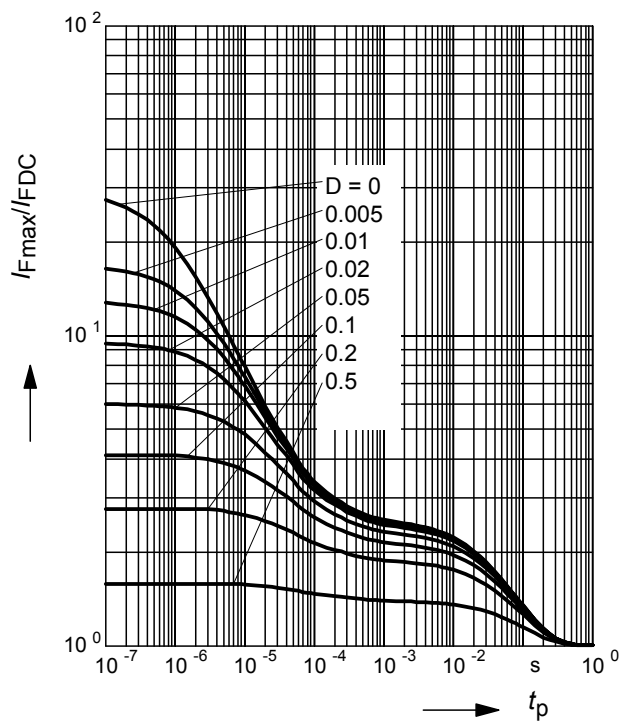

Permissible Puls Load $R_{thJS} = f(t_p)$

BAS16-02L, -07L4

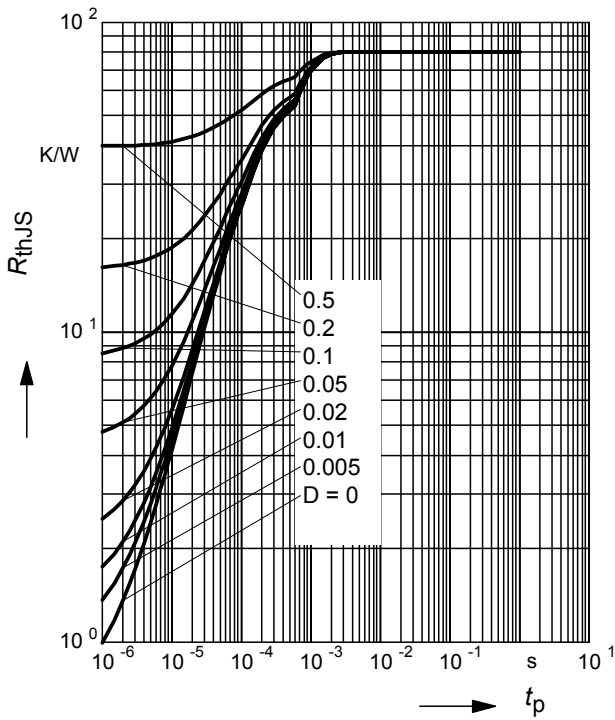

Permissible Pulse Load

$I_{Fmax} / I_{FDC} = f(t_p)$

BAS16-02L, -07L4

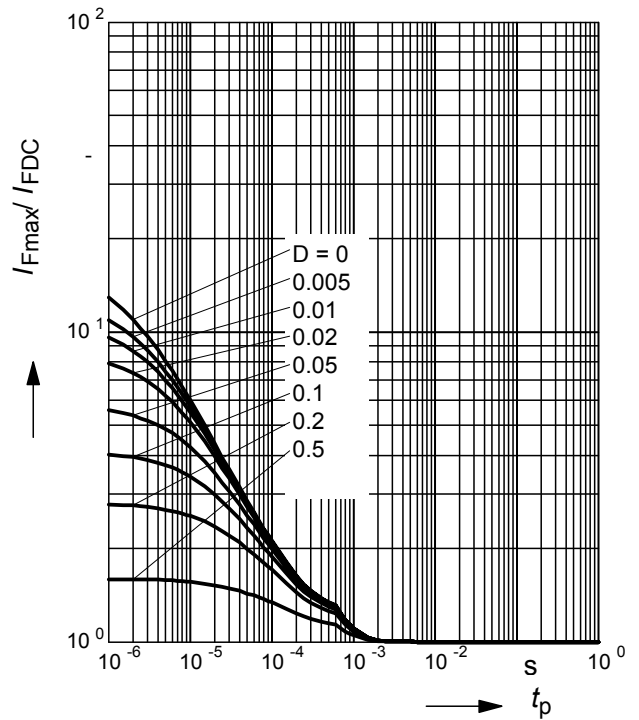

Permissible Puls Load $R_{thJS} = f(t_p)$

BAS16-02V, -02W

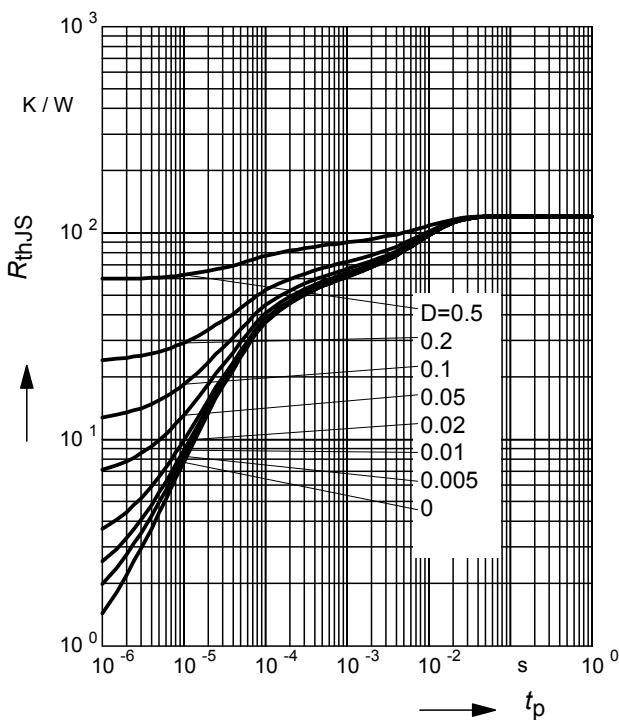

Permissible Pulse Load

$I_{Fmax} / I_{FDC} = f(t_p)$

BAS16-02V, -02W

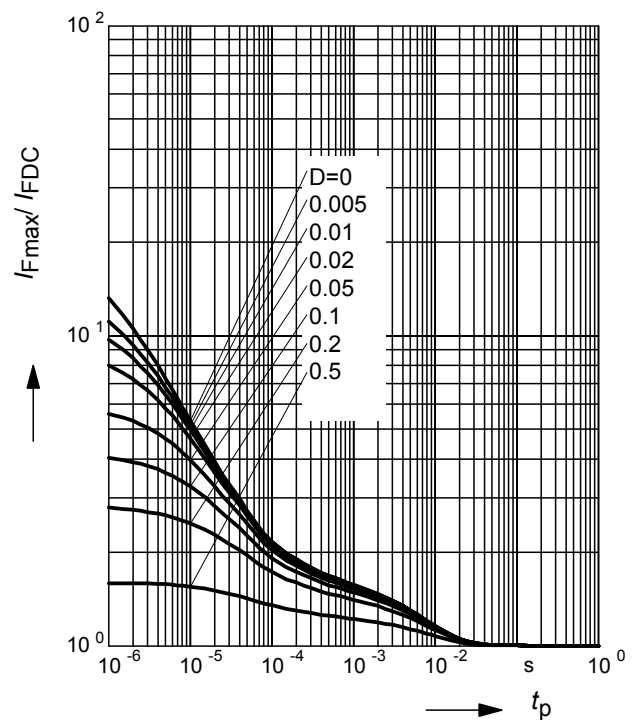

Permissible Puls Load $R_{thJS} = f(t_p)$

BAS16-03W



Permissible Pulse Load

$I_{Fmax} / I_{FDC} = f(t_p)$

BAS16-03W

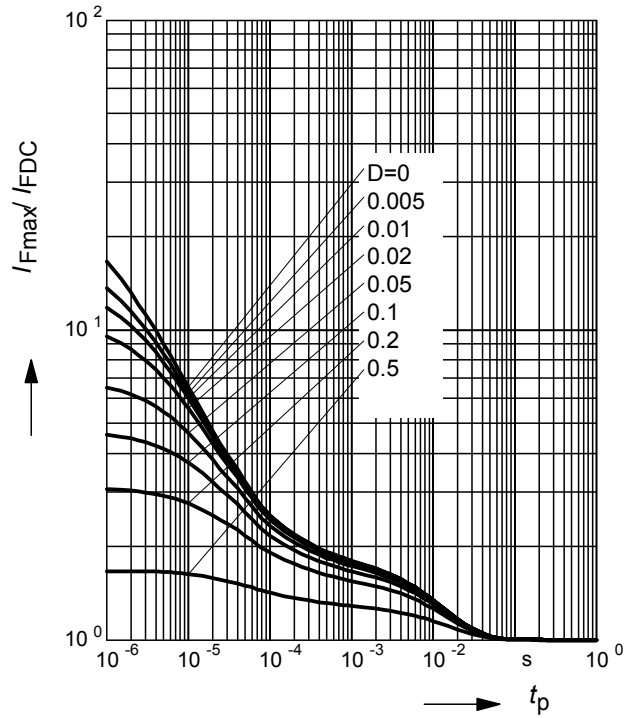

Permissible Puls Load $R_{thJS} = f(t_p)$

BAS16S

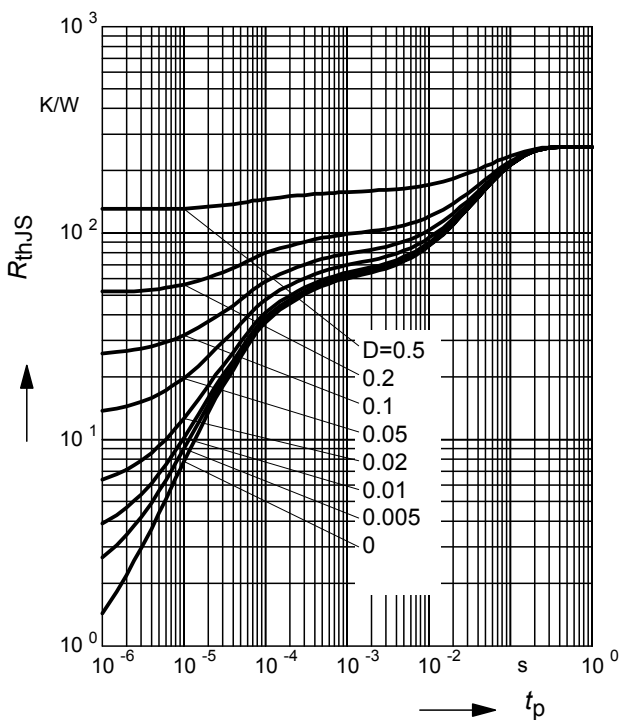

Permissible Pulse Load

$I_{Fmax} / I_{FDC} = f(t_p)$

BAS16S

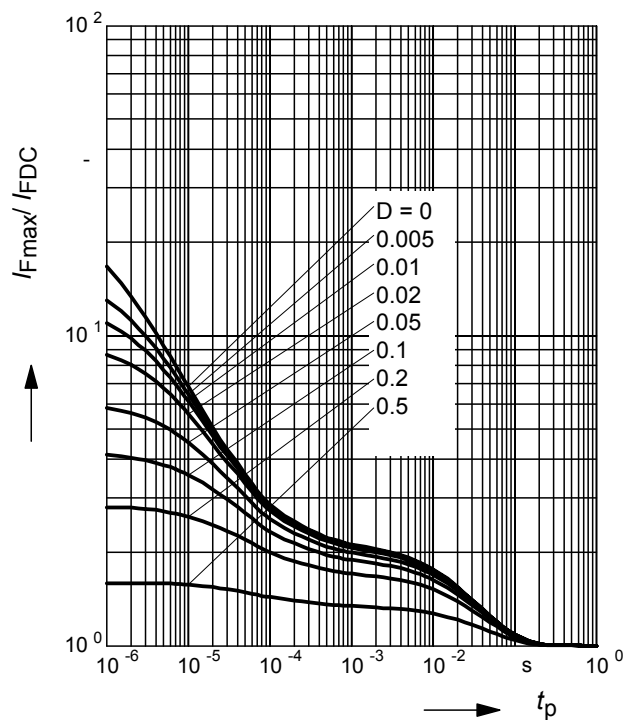

Permissible Puls Load $R_{thJS} = f(t_p)$

BAS16U

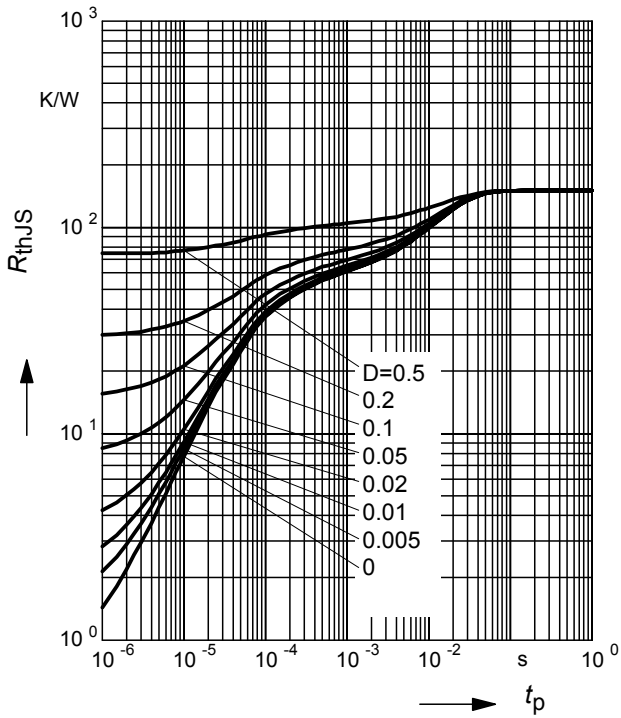

Permissible Pulse Load

$I_{Fmax} / I_{FDC} = f(t_p)$

BAS16U

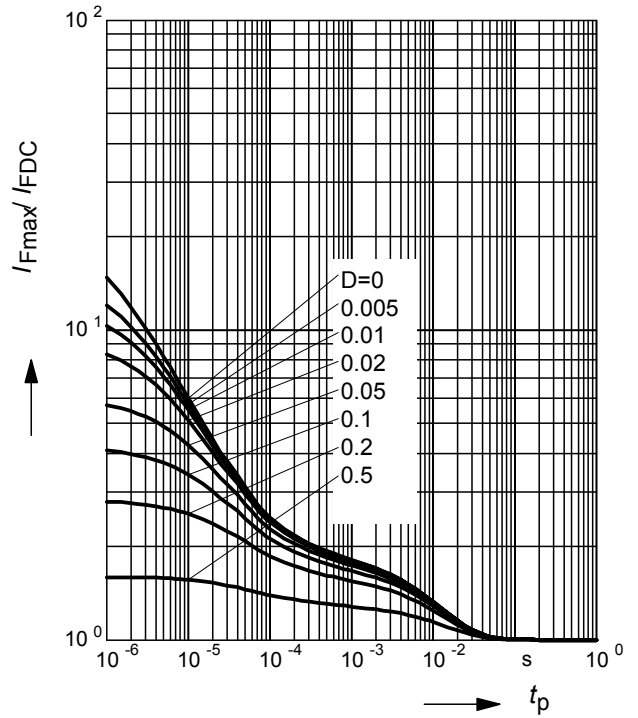

Permissible Puls Load $R_{thJS} = f(t_p)$

BAS16W



Permissible Pulse Load

$I_{Fmax} / I_{FDC} = f(t_p)$

BAS16W

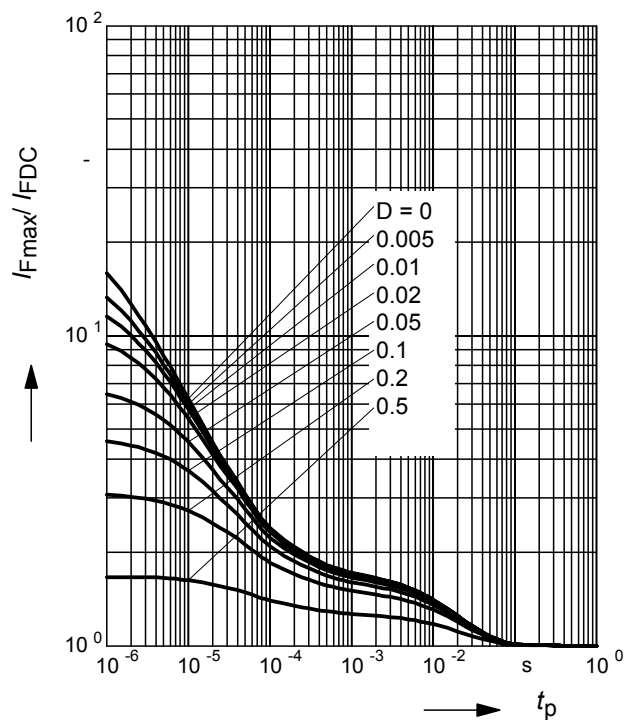

Package Outline

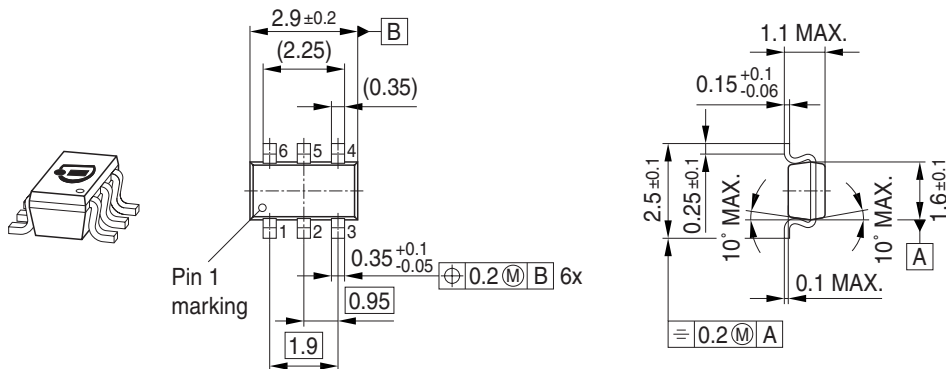

Foot Print

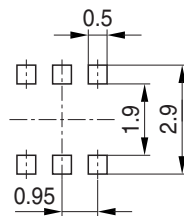

Marking Layout (Example)

Small variations in positioning of Date code, Type code and Manufacture are possible.



Standard Packing

Reel \varnothing 180 mm = 3.000 Pieces/Reel
 Reel \varnothing 330 mm = 10.000 Pieces/Reel

For symmetric types no defined Pin 1 orientation in reel.

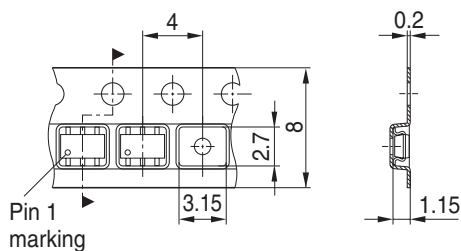

Package Outline

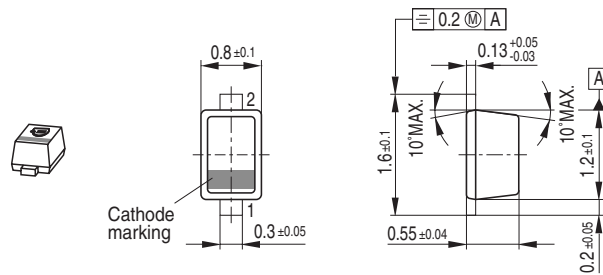

Foot Print

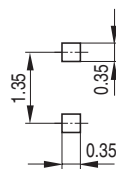

Marking Layout (Example)

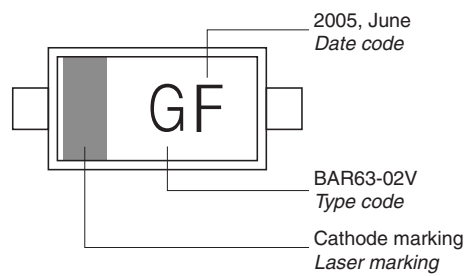

Standard Packing

Reel ø180 mm = 3.000 Pieces/Reel
 Reel ø180 mm = 8.000 Pieces/Reel (2 mm Pitch)
 Reel ø330 mm = 10.000 Pieces/Reel

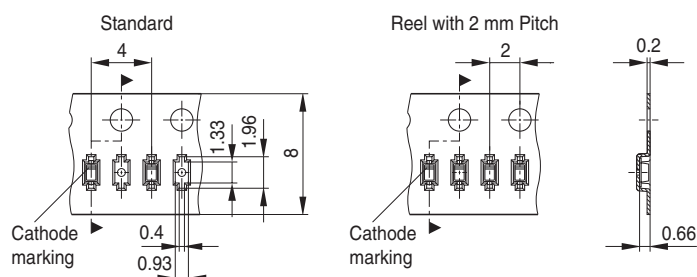

Package Outline

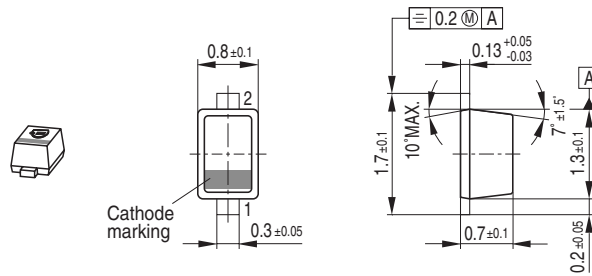

Foot Print

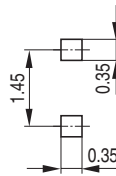

Marking Layout (Example)

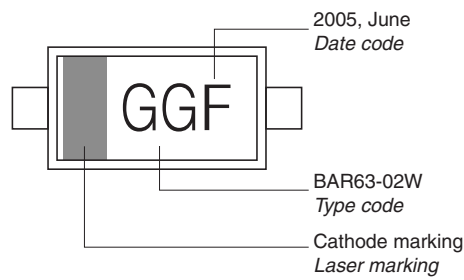

Standard Packing

- Reel ø180 mm = 3.000 Pieces/Reel
- Reel ø180 mm = 8.000 Pieces/Reel (2 mm Pitch)
- Reel ø330 mm = 10.000 Pieces/Reel

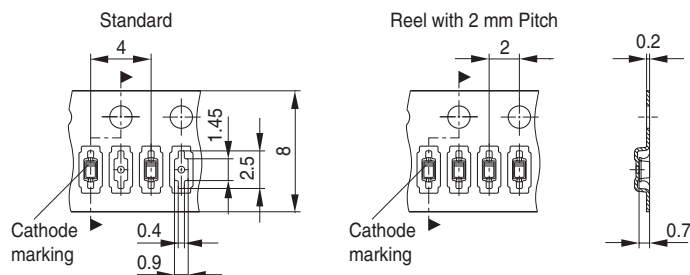

Date Code marking for discrete packages with one digit (SCD80, SC79, SC75¹⁾) CES-Code

| Month | 2003 | 2004 | 2005 | 2006 | 2007 | 2008 | 2009 | 2010 | 2011 | 2012 | 2013 | 2014 |
|-------|------|------|------|------|------|------|------|------|------|------|------|------|
| 01 | a | p | A | P | a | p | A | P | a | p | A | P |
| 02 | b | q | B | Q | b | q | B | Q | b | q | B | Q |
| 03 | c | r | C | R | c | r | C | R | c | r | C | R |
| 04 | d | s | D | S | d | s | D | S | d | s | D | S |
| 05 | e | t | E | T | e | t | E | T | e | t | E | T |
| 06 | f | u | F | U | f | u | F | U | f | u | F | U |
| 07 | g | v | G | V | g | v | G | V | g | v | G | V |
| 08 | h | x | H | X | h | x | H | X | h | x | H | X |
| 09 | j | y | J | Y | j | y | J | Y | j | y | J | Y |
| 10 | k | z | K | Z | k | z | K | Z | k | z | K | Z |
| 11 | l | 2 | L | 4 | l | 2 | L | 4 | l | 2 | L | 4 |
| 12 | n | 3 | N | 5 | n | 3 | N | 5 | n | 3 | N | 5 |

1) New Marking Layout for SC75, implemented at October 2005.

Package Outline

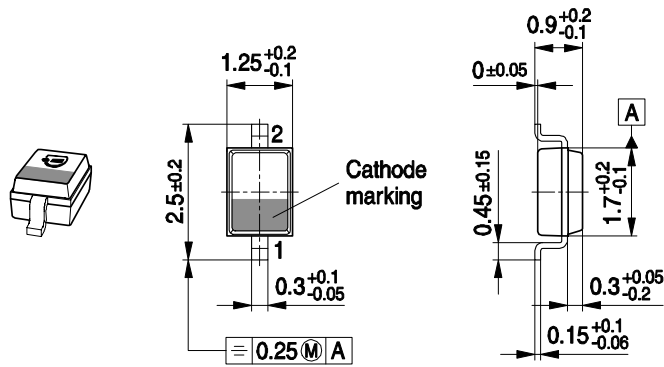

Foot Print

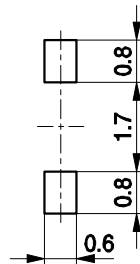

Marking Layout (Example)

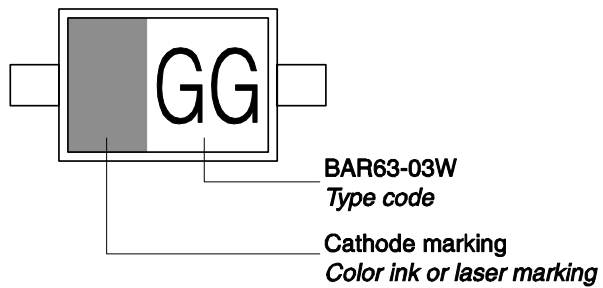

Standard Packing

Reel ø180 mm = 3.000 Pieces/Reel
 Reel ø330 mm = 10.000 Pieces/Reel

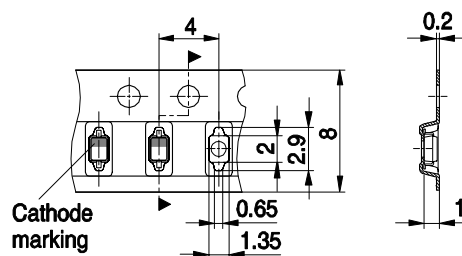

Package Outline



1) Lead width can be 0.6 max. in dambar area

Foot Print

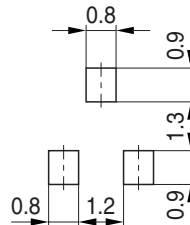

Marking Layout (Example)



Standard Packing

Reel \varnothing 180 mm = 3.000 Pieces/Reel
 Reel \varnothing 330 mm = 10.000 Pieces/Reel

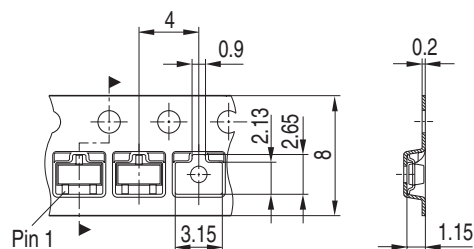

Package Outline



Foot Print



Marking Layout (Example)



Standard Packing

Reel \varnothing 180 mm = 3.000 Pieces/Reel
 Reel \varnothing 330 mm = 10.000 Pieces/Reel



Package Outline

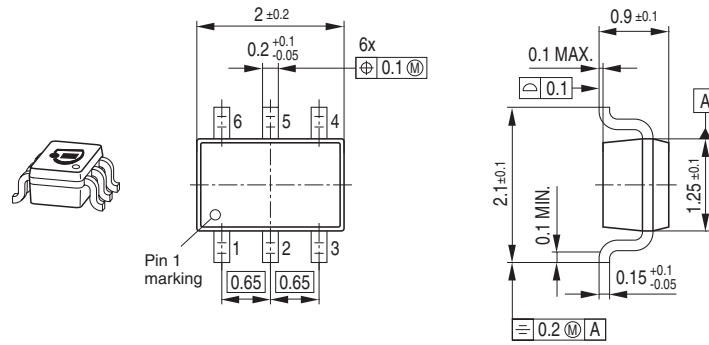

Foot Print



Marking Layout (Example)

Small variations in positioning of Date code, Type code and Manufacture are possible.



Standard Packing

Reel \varnothing 180 mm = 3.000 Pieces/Reel
 Reel \varnothing 330 mm = 10.000 Pieces/Reel

For symmetric types no defined Pin 1 orientation in reel.



Package Outline

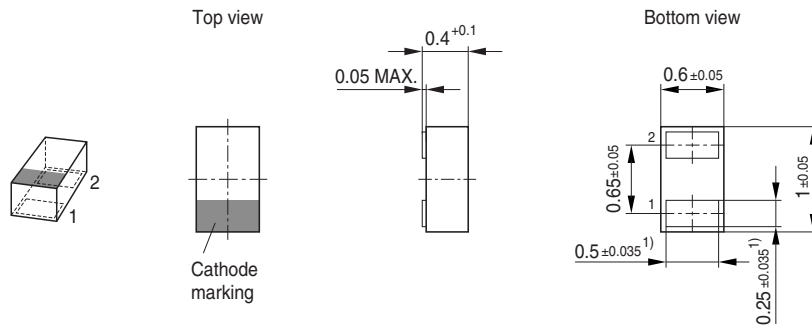

1) Dimension applies to plated terminal

Foot Print

For board assembly information please refer to Infineon website "Packages"

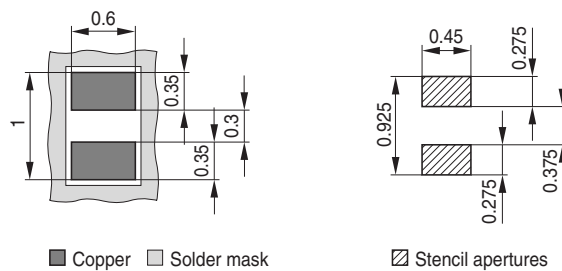

■ Copper □ Solder mask

▨ Stencil apertures

Marking Layout (Example)

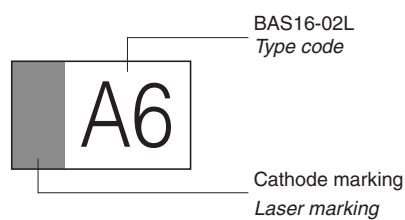

BAS16-02L
Type code

Cathode marking
Laser marking

Standard Packing

Reel \varnothing 180 mm = 15.000 Pieces/Reel
Reel \varnothing 330 mm = 50.000 Pieces/Reel (optional)

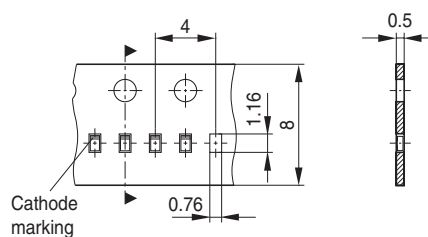

Edition 2006-02-01

Published by

Infineon Technologies AG

81726 München, Germany

© Infineon Technologies AG 2007.

All Rights Reserved.

Attention please!

The information given in this dokument shall in no event be regarded as a guarantee of conditions or characteristics ("Beschaffenheitsgarantie"). With respect to any examples or hints given herein, any typical values stated herein and/or any information regarding the application of the device, Infineon Technologies hereby disclaims any and all warranties and liabilities of any kind, including without limitation warranties of non-infringement of intellectual property rights of any third party.

Information

For further information on technology, delivery terms and conditions and prices please contact your nearest Infineon Technologies Office (www.infineon.com).

Warnings

Due to technical requirements components may contain dangerous substances. For information on the types in question please contact your nearest Infineon Technologies Office.

Infineon Technologies Components may only be used in life-support devices or systems with the express written approval of Infineon Technologies, if a failure of such components can reasonably be expected to cause the failure of that life-support device or system, or to affect the safety or effectiveness of that device or system.

Life support devices or systems are intended to be implanted in the human body, or to support and/or maintain and sustain and/or protect human life. If they fail, it is reasonable to assume that the health of the user or other persons may be endangered.

Компания «Океан Электроники» предлагает заключение долгосрочных отношений при поставках импортных электронных компонентов на взаимовыгодных условиях!

Наши преимущества:

- Поставка оригинальных импортных электронных компонентов напрямую с производств Америки, Европы и Азии, а так же с крупнейших складов мира;
- Широкая линейка поставок активных и пассивных импортных электронных компонентов (более 30 млн. наименований);
- Поставка сложных, дефицитных, либо снятых с производства позиций;
- Оперативные сроки поставки под заказ (от 5 рабочих дней);
- Экспресс доставка в любую точку России;
- Помощь Конструкторского Отдела и консультации квалифицированных инженеров;
- Техническая поддержка проекта, помощь в подборе аналогов, поставка прототипов;
- Поставка электронных компонентов под контролем ВП;
- Система менеджмента качества сертифицирована по Международному стандарту ISO 9001;
- При необходимости вся продукция военного и аэрокосмического назначения проходит испытания и сертификацию в лаборатории (по согласованию с заказчиком);
- Поставка специализированных компонентов военного и аэрокосмического уровня качества (Xilinx, Altera, Analog Devices, Intersil, Interpoint, Microsemi, Actel, Aeroflex, Peregrine, VPT, Syfer, Eurofarad, Texas Instruments, MS Kennedy, Miteq, Cobham, E2V, MA-COM, Hittite, Mini-Circuits, General Dynamics и др.);

Компания «Океан Электроники» является официальным дистрибьютором и эксклюзивным представителем в России одного из крупнейших производителей разъемов военного и аэрокосмического назначения «JONHON», а так же официальным дистрибьютором и эксклюзивным представителем в России производителя высокотехнологичных и надежных решений для передачи СВЧ сигналов «FORSTAR».



JONHON

«JONHON» (основан в 1970 г.)

Разъемы специального, военного и аэрокосмического назначения:

(Применяются в военной, авиационной, аэрокосмической, морской, железнодорожной, горно- и нефтедобывающей отраслях промышленности)

«FORSTAR» (основан в 1998 г.)

ВЧ соединители, коаксиальные кабели, кабельные сборки и микроволновые компоненты:

(Применяются в телекоммуникациях гражданского и специального назначения, в средствах связи, РЛС, а так же военной, авиационной и аэрокосмической отраслях промышленности).



Телефон: 8 (812) 309-75-97 (многоканальный)

Факс: 8 (812) 320-03-32

Электронная почта: ocean@oceanchips.ru

Web: <http://oceanchips.ru/>

Адрес: 198099, г. Санкт-Петербург, ул. Калинина, д. 2, корп. 4, лит. А