

Features

Unregulated Converter

- 1 : 1 Input Range
- 0.5W SMD Package
- Efficiency up to 80%
- Approved for Medical Applications
- 1kVDC and 3 kVDC Isolation Option
- Operating Temperature from -40°C to +100°C

Specifications (measured at $T_A = 25^\circ\text{C}$, nominal input voltage, full load and after warm-up)

Part Number SMD	Input Voltage (VDC)	Output Voltage (VDC)	Output Current (mA)	Efficiency typ. (%)	Max Capacitive Load ⁽¹⁾ **
R0.5S**-3.305*	3.3	5	100	80	1000µF
R0.5S**-3.312*	3.3	12	42	77	150µF
R0.5S**-3.315*	3.3	15	33	77	150µF
R0.5S**-0505*	5	5	100	72	1000µF
R0.5S**-0512*	5	12	42	77	150µF
R0.5S**-0515*	5	15	33	79	150µF
R0.5S**-1205*	12	5	100	74	1000µF
R0.5S**-1212*	12	12	42	75	150µF
R0.5S**-1215*	12	15	33	75	150µF
R0.5S**-2405*	24	5	100	75	1000µF
R0.5S**-2412*	24	12	42	77	150µF
R0.5S**-2415*	24	15	33	77	150µF
R0.5D**-3.305*	3.3	±5	±50	79	±470µF
R0.5D**-3.312*	3.3	±12	±21	76	±68µF
R0.5D**-3.315*	3.3	±15	±17	77	±68µF
R0.5D**-0505*	5	±5	±50	79	±470µF
R0.5D**-0512*	5	±12	±21	77	±68µF
R0.5D**-0515*	5	±15	±17	79	±68µF
R0.5D**1205*	12	±5	±50	76	±470µF
R0.5D**1212*	12	±12	±21	75	±68µF
R0.5D**1215*	12	±15	±17	75	±68µF
R0.5D**2405*	24	±5	±50	77	±470µF
R0.5D**2412*	24	±12	±21	75	±68µF
R0.5D**2415*	24	±15	±17	75	±68µF

*add Suffix "/H" for 3kVDC Isolation Voltage

*add Suffix "/P" for continuous short circuit protection

*add Suffix "-R" for tape & reel packing

For more details and dimensions of the tapes and reels see Application Notes

R0.5S**:

**without marking denotes 5 pins out of 8 fitted (includes „/H“ option)

**with marking 8 denotes 8 pins out of 8 fitted („/H“ option not available)

**with marking 12 denotes 10 pins out of 12 fitted (includes „/H“ option)

R0.5D**:

**without marking denotes 6 pins out of 10 fitted (includes „/H“ option)

**with marking 10 denotes 10 pins out of 10 fitted („/H“ option not available)

**with marking 12 denotes 10 pins out of 12 fitted (includes „/H“ option)

ECONOLINE

DC/DC-Converter

with 3 year Warranty

RECOM

0.5 Watt SMD Isolated Single or Dual Output



UL-60950-1 Certified

RO.5S_D

Derating-Graph (Ambient Temperature)

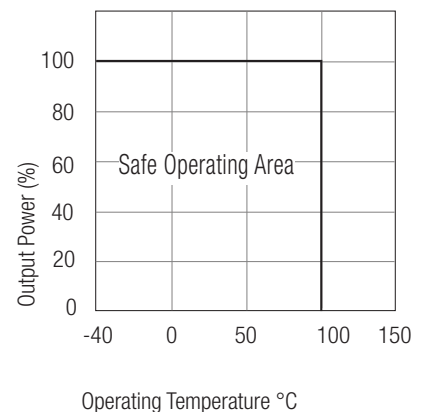

Refer to Application Notes

Specifications (measured at $T_A = 25^\circ\text{C}$, nominal input voltage, full load and after warm-up)

Input Voltage Range		$\pm 10\%$ max.
Voltage Set Accuracy	100% Load/nominal Vin	-1% typ. / $\pm 5\%$ max.
Line Regulation	Low Line to High Line @ max. Load	1.2% typ.
Load Regulation	5V output	6% typ. / 15% max.
(10% to 100% Load)	12/15V output	5%typ. / 10% max.
Ripple & Noise @ 20MHz BW		50 mVp-p typ. / 100mVp-p max.
Efficiency at Full Load		70% min.
Operating Temperature		-40°C to +100°C
Storage Temperature		-55°C to +125°C
Isolation Voltage	(tested for 1 second) (rated for 1 minute ^{***})	1000VDC 500VAC / 60Hz
Isolation Voltage	H-Suffix (tested for 1 second) H-Suffix (rated for 1 minute ^{***})	3000VDC 1500VAC / 60Hz
Isolation Capacitance		75pF max.
Isolation Resistance	Viso = 500V	10 G Ω min.
Humidity		95% max.
Operating Frequency	Vin (nom.)	20kHz min. / 50 kHz typ. / 90 kHz max.
Short-Circuit Protection		1 Second
MTBF	Using MIL-HDBK 217F (+100°C)	1003 x 10 ³ hours
Using MIL-HDBK 217F (+25°C)	3962 x 10 ³ hours	<i>Detailed Information see Application Notes chapter „MTBF“</i>
Weight	Single Types	1.0 g
	Dual Types	1.2 g
Certification		
UL General Safety	Report: E358085	UL 60950-1 2nd Ed.

^{***}Any data referred to in this datasheet are of indicative nature and based on our practical experience only. For further details, please refer to our Application Notes.

Notes

Note1: Maximum capacitive load is defined as the capacitive load that will allow start up in under 1second without damage to the converter.

Typical Characteristics

Tolerance Envelope

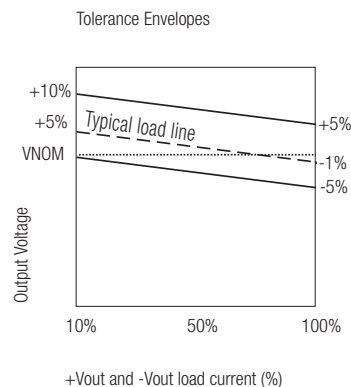

Typical Characteristics

R0.5S-3.3xx

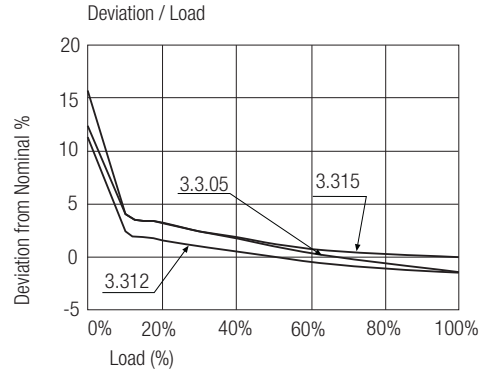
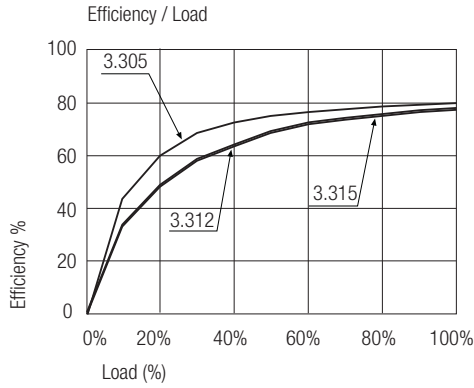

R0.5S-05xx

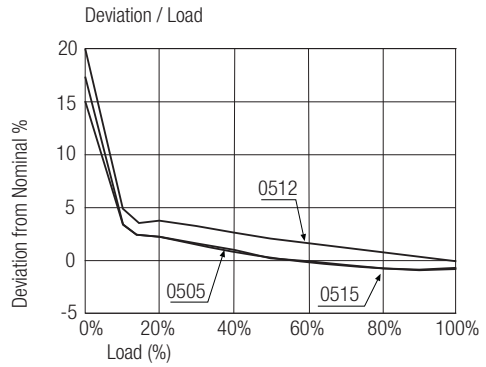
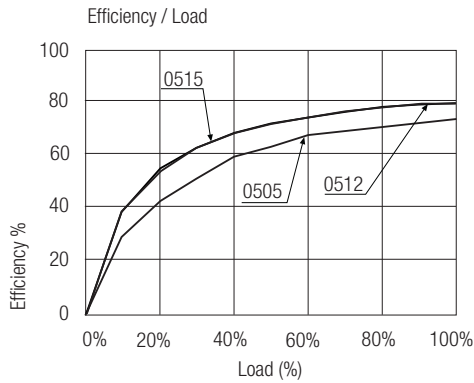

R0.5S-12xx

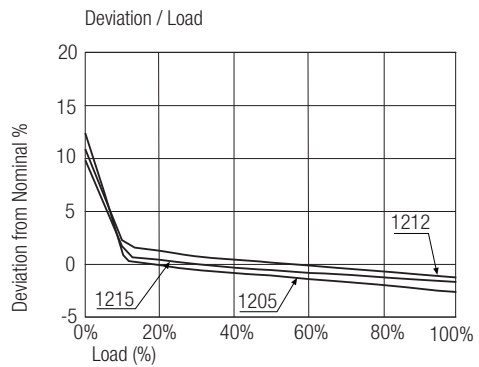
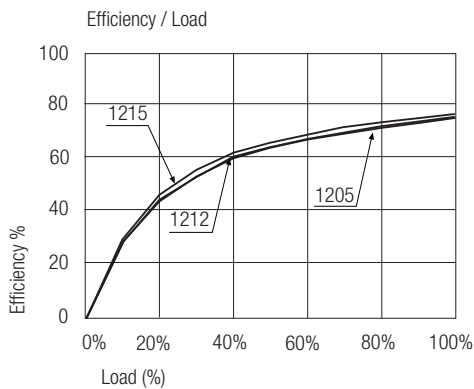

R0.5S-24xx

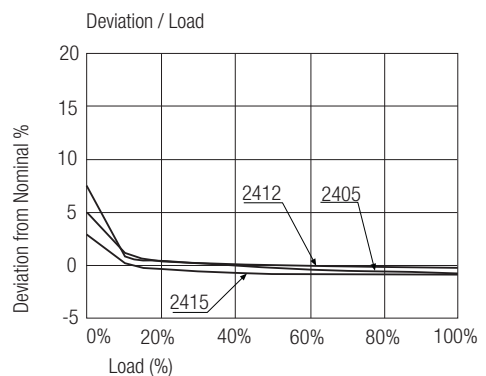
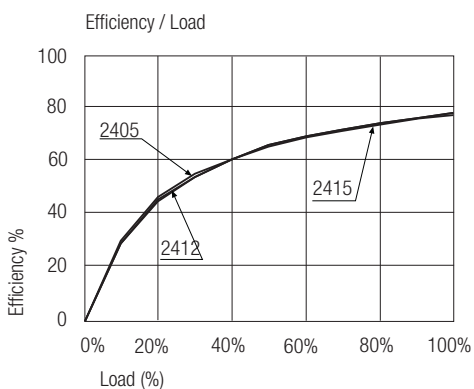

ECONOLINE

DC/DC-Converter

R0.55_D Series

Typical Characteristics

R0.5D-3.3xx

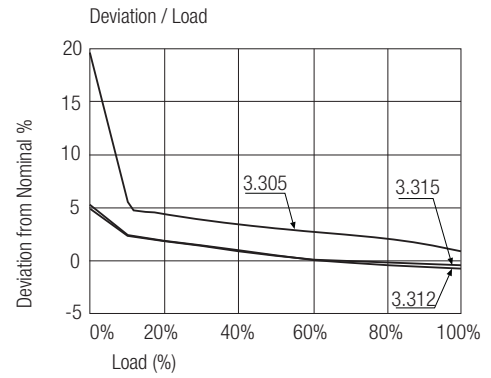
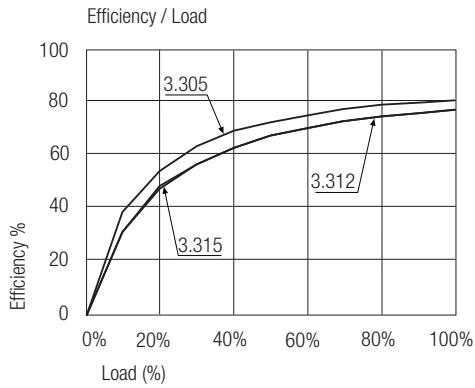

R0.5D-05xx

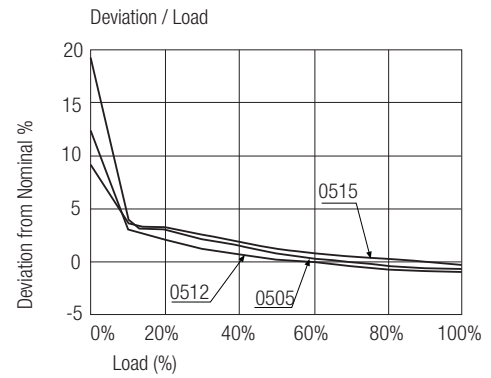
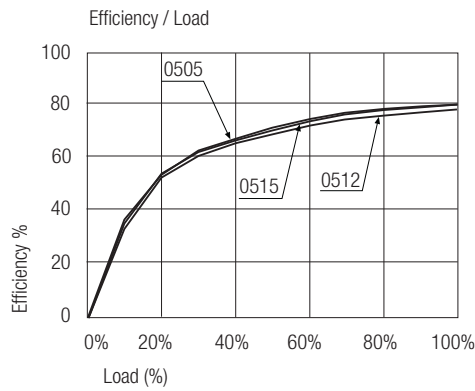

R0.5D-12xx

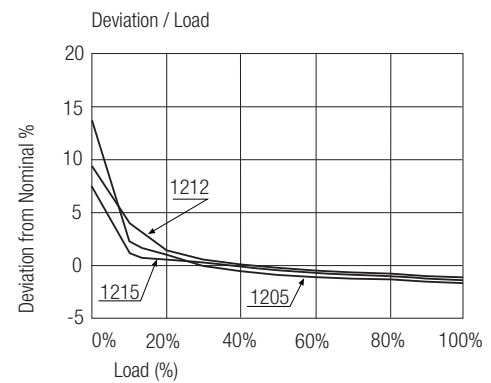
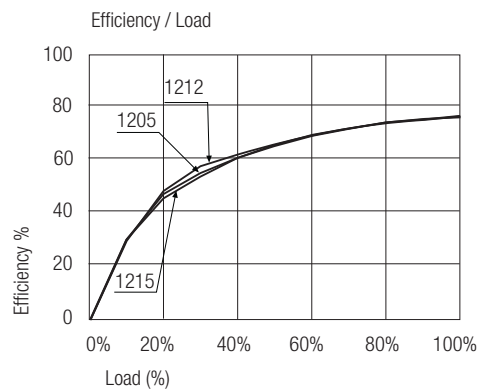

R0.5D-24xx

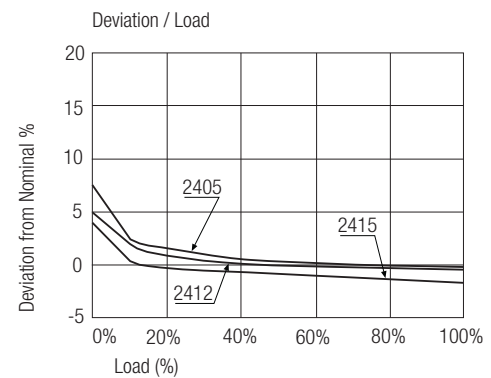
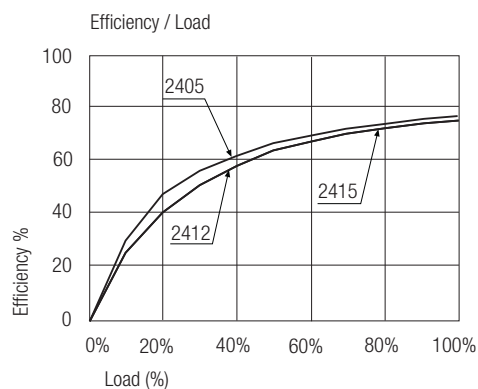

R0.55_D

Single Output

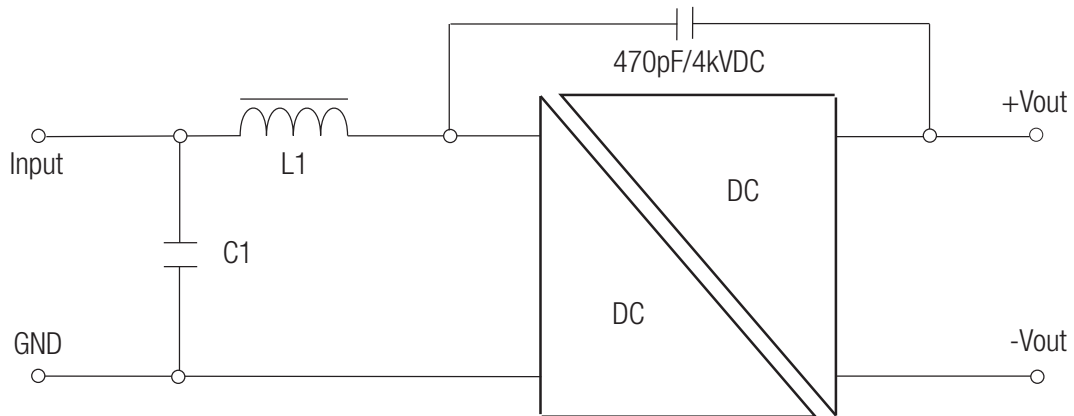

Except „/P“ Versions

C1	L1	Vin
4.7µF	4.7µH	3.3V
4.7µF	4.7µH	5V
4.7µF	4.7µH	12V
2.2µF	4.7µH	15V

Dual Output

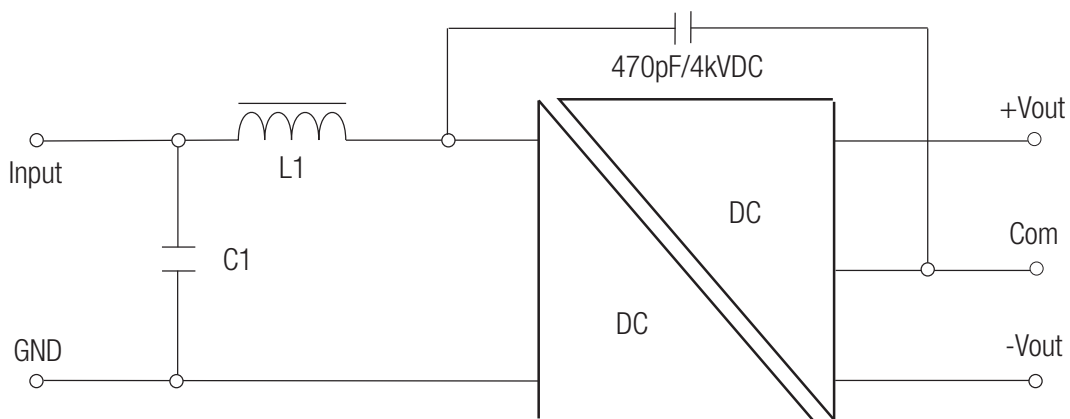

Except „/P“ Versions

C1	L1	Vin
4.7µF	10µH	3.3V
4.7µF	4.7µH	5V
4.7µF	2.2µH	12V
4.7µF	2.2µH	15V

C1 = MLCC
L1 = SMD Inductor

Package Style and Pinning (mm)

5 PINS Single SMD Package

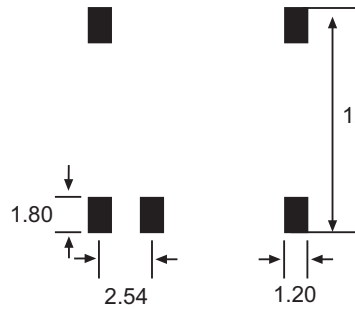
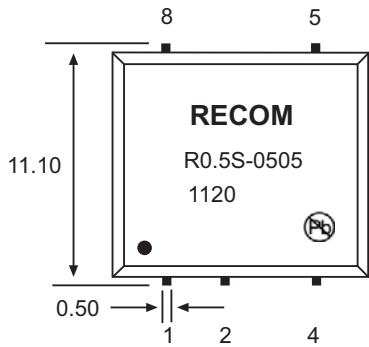
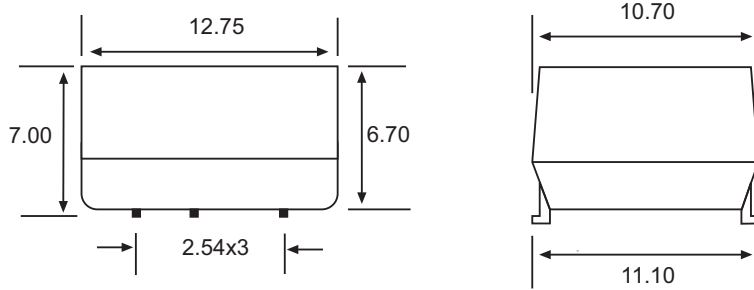

Footprint

Pin Connections

Pin #	Single	Dual
1	-Vin	-Vin
2	+Vin	+Vin
4	-Vout	Com.
5	+Vout	-Vout
7	No Pin	+Vout
8	NC	No Pin
10	No Pin	NC

NC= No Connection

UNIT: mm

TOL.: ± 0.25 mm

6 PINS Dual SMD Package

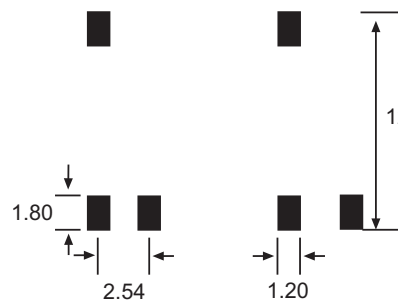
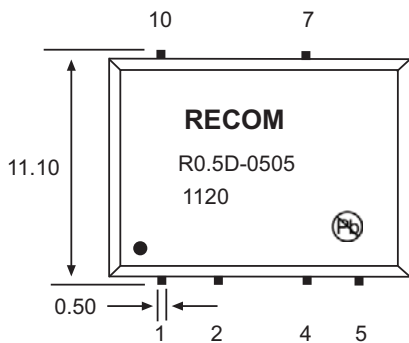
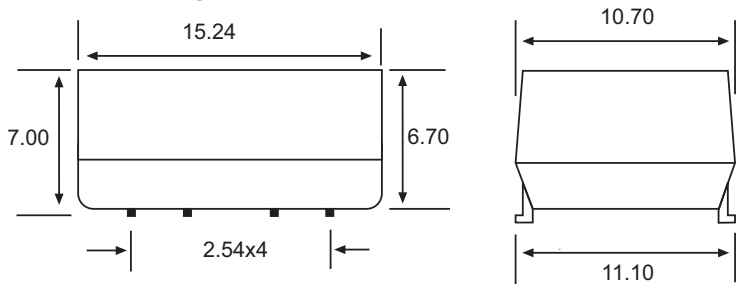

Footprint

Package Style and Pinning (mm)

8 PINS Single SMD Package

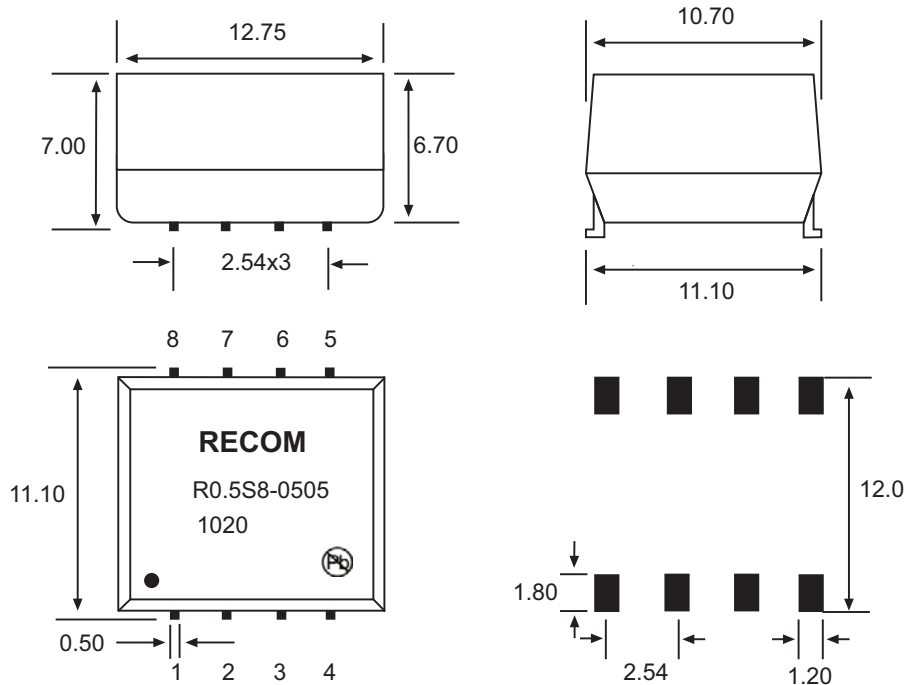

Footprint

Pin Connections

Pin #	Single	Dual
1	-Vin	-Vin
2	+Vin	+Vin
4	-Vout	Com.
5	+Vout	-Vout
7	NC	+Vout
3, 6, 8	NC	NC
9, 10	No Pin	NC

NC= No Connection

UNIT: mm

TOL.: ± 0.25 mm

10 PINS Dual SMD Package

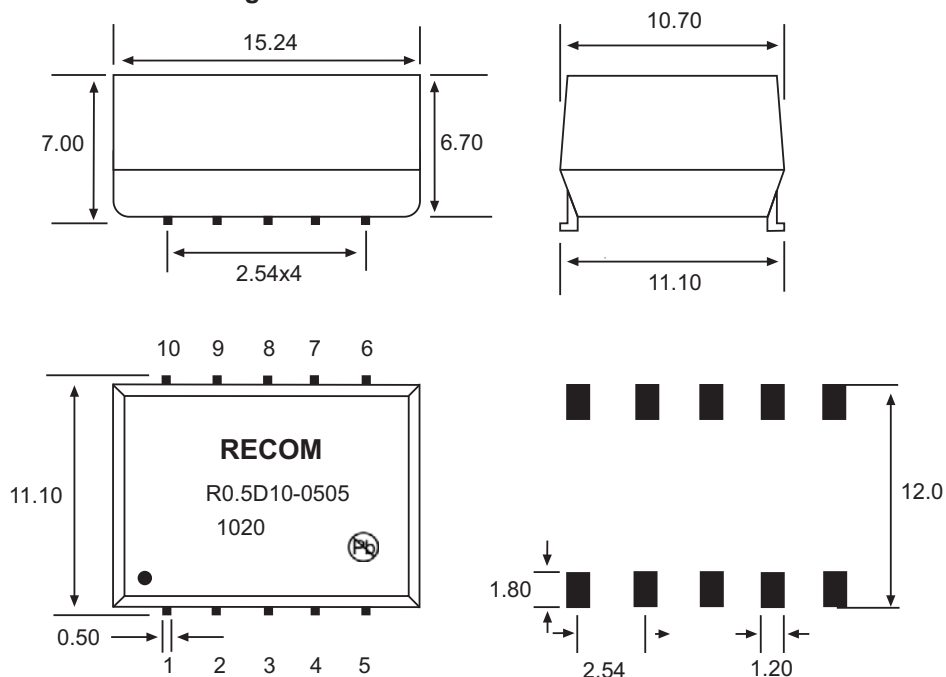

Footprint

ECONOLINE

DC/DC-Converter

R0.55_D Series

Package Style and Pinning (mm)

12 PINS Dual SMD Package

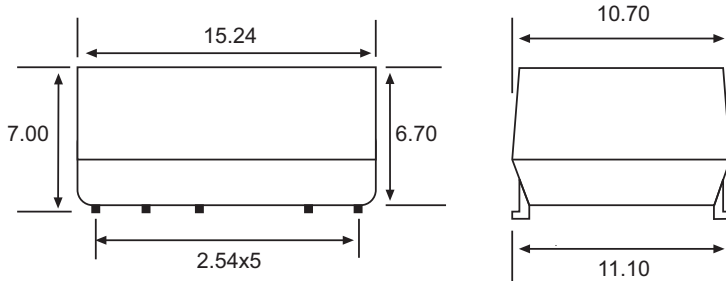

Pin Connections

Pin #	Function Single	Function Dual
1	-Vin	-Vin
2	+Vin	+Vin
5	-Vout	Com.
6	NC	-Vout
8	+Vout	+Vout
3,7,10,11,12	NC	NC

NC= No Connection

Unit: mm

TOL.: ± 0.25 mm

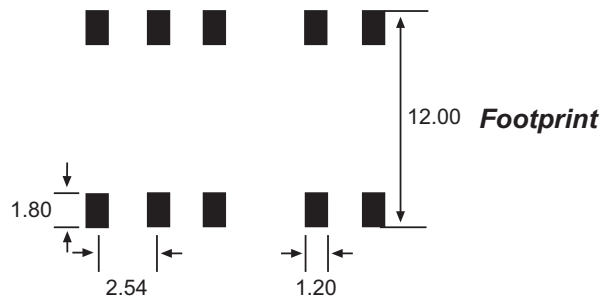
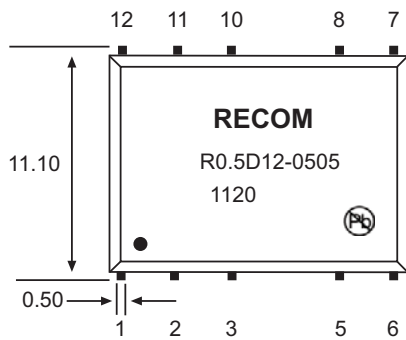

Footprint

The product information and specifications are subject to change without prior notice. RECOM products are not authorized for use in safety-critical applications (such as life support) without RECOM's explicit written consent. A safety-critical application is defined as an application where a failure of a RECOM product may reasonably be expected to endanger or cause loss of life, inflict bodily harm or damage property. The buyer shall indemnify and hold harmless RECOM, its affiliated companies and its representatives against any damage claims in connection with the unauthorized use of RECOM products in such safety-critical applications.

Компания «Океан Электроники» предлагает заключение долгосрочных отношений при поставках импортных электронных компонентов на взаимовыгодных условиях!

Наши преимущества:

- Поставка оригинальных импортных электронных компонентов напрямую с производств Америки, Европы и Азии, а так же с крупнейших складов мира;
- Широкая линейка поставок активных и пассивных импортных электронных компонентов (более 30 млн. наименований);
- Поставка сложных, дефицитных, либо снятых с производства позиций;
- Оперативные сроки поставки под заказ (от 5 рабочих дней);
- Экспресс доставка в любую точку России;
- Помощь Конструкторского Отдела и консультации квалифицированных инженеров;
- Техническая поддержка проекта, помощь в подборе аналогов, поставка прототипов;
- Поставка электронных компонентов под контролем ВП;
- Система менеджмента качества сертифицирована по Международному стандарту ISO 9001;
- При необходимости вся продукция военного и аэрокосмического назначения проходит испытания и сертификацию в лаборатории (по согласованию с заказчиком);
- Поставка специализированных компонентов военного и аэрокосмического уровня качества (Xilinx, Altera, Analog Devices, Intersil, Interpoint, Microsemi, Actel, Aeroflex, Peregrine, VPT, Syfer, Eurofarad, Texas Instruments, MS Kennedy, Miteq, Cobham, E2V, MA-COM, Hittite, Mini-Circuits, General Dynamics и др.);

Компания «Океан Электроники» является официальным дистрибьютором и эксклюзивным представителем в России одного из крупнейших производителей разъемов военного и аэрокосмического назначения «JONHON», а так же официальным дистрибьютором и эксклюзивным представителем в России производителя высокотехнологичных и надежных решений для передачи СВЧ сигналов «FORSTAR».



JONHON

«JONHON» (основан в 1970 г.)

Разъемы специального, военного и аэрокосмического назначения:

(Применяются в военной, авиационной, аэрокосмической, морской, железнодорожной, горно- и нефтедобывающей отраслях промышленности)

«FORSTAR» (основан в 1998 г.)

ВЧ соединители, коаксиальные кабели, кабельные сборки и микроволновые компоненты:

(Применяются в телекоммуникациях гражданского и специального назначения, в средствах связи, РЛС, а так же военной, авиационной и аэрокосмической отраслях промышленности).



Телефон: 8 (812) 309-75-97 (многоканальный)

Факс: 8 (812) 320-03-32

Электронная почта: ocean@oceanchips.ru

Web: <http://oceanchips.ru/>

Адрес: 198099, г. Санкт-Петербург, ул. Калинина, д. 2, корп. 4, лит. А