

Devices Connected/Referenced

ADA4817-2	Low Noise, 1 GHz FastFET Dual Op Amp
ADA4830-1	High Speed Difference Amplifier with Input Short-to-Battery Protection

High Speed FET Input Instrumentation Amplifier with Low Input Bias Current and High AC Common-Mode Rejection

EVALUATION AND DESIGN SUPPORT

Circuit Evaluation Boards

[CN-0273 Circuit Evaluation Board \(EVAL-CN0273-EB1Z\)](#)

Design and Integration Files

[Schematics, Layout Files, Bill of Materials](#)

CIRCUIT FUNCTION AND BENEFITS

The circuit shown in Figure 1 is a high speed FET input, gain-of-5 instrumentation amplifier (in-amp) with a wide bandwidth (35 MHz) and excellent ac common-mode rejection, CMR, (55 dB at 10 MHz). The circuit is ideal for applications where a high input impedance, fast in-amp is required, including RF, video, optical signal sensing, and high speed instrumentation. The high CMR and bandwidth also makes it ideal as a wideband differential line receiver.

Most discrete in-amps require expensive matched resistor networks to achieve high CMR; however, this circuit uses an integrated difference amplifier with on-chip matched resistors to improve performance, reduce cost, and minimize printed circuit board (PCB) layout area.

The composite in-amp circuit shown in Figure 1 has the following performance:

- Offset voltage: 4 mV maximum
- Input bias current: 2 pA typical
- Input common-mode voltage: -3.5 V to $+2.2\text{ V}$ maximum
- Input differential voltage: $\pm 3.5\text{ V}/G_1$ maximum, where G_1 is the gain of the first stage
- Output voltage swing: 0.01 V to 4.75 V typical with 150 Ω load
- Bandwidth (-3 dB): 35 MHz typical for $G = 5$
- Common-mode rejection: 55 dB at 10 MHz typical
- Input voltage noise: 10 nV/ $\sqrt{\text{Hz}}$ at 100 kHz RTI typical
- Harmonic distortion: -60 dBc at 10 MHz, $G = 5$, $V_{\text{OUT}} = 1\text{ V p-p}$, $R_L = 1\text{ k}\Omega$.

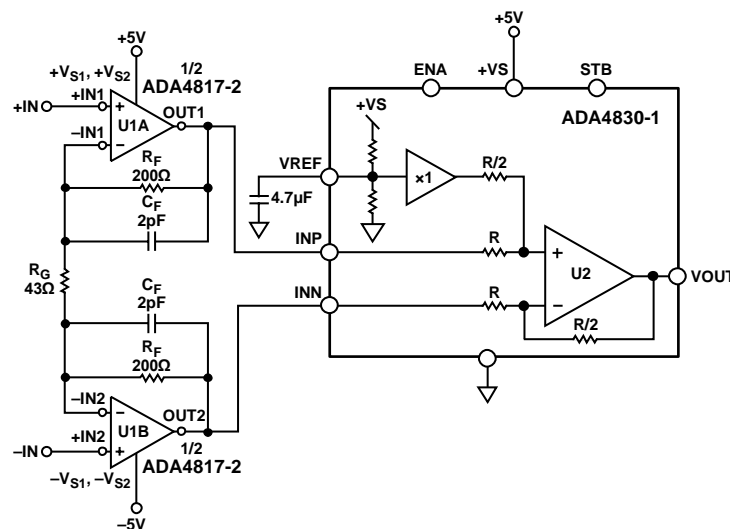

Figure 1. High Speed FET Input Instrumentation Amplifier (Note: Power Supply Decoupling Not Shown)

Rev. B

Circuits from the Lab™ circuits from Analog Devices have been designed and built by Analog Devices engineers. Standard engineering practices have been employed in the design and construction of each circuit, and their function and performance have been tested and verified in a lab environment at room temperature. However, you are solely responsible for testing the circuit and determining its suitability and applicability for your use and application. Accordingly, in no event shall Analog Devices be liable for direct, indirect, special, incidental, consequential or punitive damages due to any cause whatsoever connected to the use of any Circuits from the Lab circuits. (Continued on last page)

Most fully integrated in-amps are fabricated on bipolar or complementary bipolar processes and are optimized for low frequency applications with high CMR at 50 Hz or 60 Hz. However, there is a growing need for wide bandwidth in-amps for video and RF systems to amplify high speed signals and provide common-mode rejection of unwanted high frequency signals.

When a very high speed, wide bandwidth in-amp is needed, one common approach is to use two discrete op amps with high input impedance to buffer and amplify the differential input signal in the first stage, and then configure a single amplifier as a difference amplifier in the second stage to provide a differential-to-single-ended conversion. This configuration is known generally as a 3-op-amp in-amp. This approach requires four relatively expensive precision-matched resistors for good CMR. Errors in matching produce errors at the final output.

The circuit shown in Figure 1 solves this problem by using the [ADA4830-1](#) integrated high speed difference amplifier. The laser-trimmed thin film resistors are matched to very high precision, thereby eliminating the need for four relatively expensive precision-matched external resistors.

In addition, the use of the high speed, dual [ADA4817-2](#) as the input stage amplifier allows the composite in-amp to provide a bandwidth as high as 80 MHz when the overall gain of the circuit is 2.5.

The use of the dual [ADA4817-2](#) amplifiers in a single 4 mm × 4 mm LFCSP package and the integrated [ADA4830-1](#) difference amplifier significantly reduces board space, thereby reducing design costs for large systems.

The circuit can be used in noisy environments because both the [ADA4817-2](#) and [ADA4830-1](#) offer low noise and excellent CMR performance at high frequencies.

CIRCUIT DESCRIPTION

The circuit is based on the traditional 3-op-amp in-amp topology with two op amps for the input gain stage and a difference amplifier for the output stage. The circuit has a gain of 5 and a bandwidth of 35 MHz.

FET Amplifier Input Gain Stage

The [ADA4817-2](#) (dual) *FastFET* amplifiers are unity-gain stable, ultrahigh speed voltage feedback amplifiers with FET inputs. These amplifiers are fabricated on Analog Devices, Inc., proprietary eXtra Fast Complementary Bipolar (XFCB) process, which allows the amplifiers to achieve ultralow noise as well as very high input impedances and high speed, making it ideal for applications where high speed and high source impedances are required.

The [ADA4817-2](#) op amps are configured so that they share the R_G gain resistor. The circuit has a gain of $1 + 2R_F/R_G$ for the differential inputs. When the inputs are common-mode, there is no current flowing through the R_G gain resistor. Thus, the circuit acts as a buffer for the common-mode inputs. The

common-mode inputs are then effectively removed by the second stage difference amplifier.

The [ADA4817-2](#) has a unity-gain bandwidth product, f_u , of 410 MHz. Its close-looped bandwidth can be approximated by

$$f_{-3\text{dB}} = f_u/G1$$

where $G1$ is the gain of the first stage.

For this circuit, with a first stage closed-loop gain of 10, the -3 dB bandwidth is estimated to be 41 MHz. This is very close to the tested bandwidth of 35 MHz.

Parasitic capacitance in the PCB boards and capacitive loads can cause the first gain stage to oscillate. This issue can be alleviated by using low value feedback resistors, and the use of feedback capacitance.

For this circuit, a feedback resistor of 200 Ω was chosen. The feedback capacitor, C_F , was 2 pF for the best bandwidth flatness.

Difference Amplifier and CMR

The [ADA4830-1](#) is high speed difference amplifier with a wide common-mode voltage range. It combines high speed and precision. It offers a fixed gain of 0.5 V/V, and -3 dB bandwidth of 84 MHz. The on-chip, laser-trimmed resistors yield a typical CMR of 55 dB at 10MHz.

CMR is a very important specification for in-amps and depends mostly on the ratio matching of the four resistors used in the second stage difference amplifier, as is shown in Figure 2.

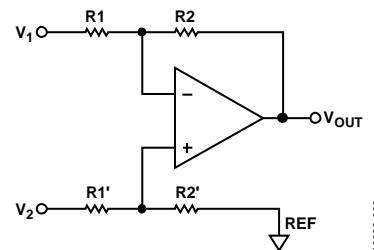

Figure 2. Difference Amplifier

In general, the worst-case CMR is given by

$$CMR \text{ (dB)} = 20\log \left[\frac{1 + R2/R1}{4Kr} \right]$$

where Kr is the individual resistor tolerance in fractional form. The previous equation shows that the worst-case CMR for four resistors with the same nominal values (1% tolerance) is 34 dB. Instead of using discrete resistors, this circuit uses a monolithic [ADA4830-1](#) difference amplifier with on-chip, laser-trimmed thin film resistors, thereby providing excellent CMR and saving PCB space. The CMR is 65 dB at dc and 55 dB at 10 MHz.

Differential and Common-Mode Voltage Considerations

To maximize the input voltage range and simplify the power supply requirements, the first stage of the circuit operates on ± 5 V, whereas the second stage operates at +5 V. The maximum differential input range is determined by the output swing of the ADA4817-2. With a ± 5 V supply, the ADA4817-2 has an output swing of ± 3.5 V. Therefore, the maximum allowable differential input is ± 3.5 V/G1, where G1 is the gain of the first stage. Note that there is a tradeoff between the maximum allowable differential input and the closed-loop gain of the first stage.

The next step is to analyze the common-mode voltage restrictions. The common-mode voltage at the input to the ADA4817-2 must fall between $-V_s$ to $+V_s - 1.8$ V, or -5 V to $+2.2$ V for ± 5 V supplies. The output swing of the ADA4817-2 is limited to ± 3.5 V when operating on ± 5 V supplies (refer to the ADA4817-2 data sheet). The negative input common-mode voltage of the circuit is therefore limited to -3.5 V by the output swing of the ADA4817-2. Therefore, the allowable input common-mode range for the composite circuit is -3.5 V to $+2.2$ V.

To achieve high performance from this circuit, excellent layout, grounding, and decoupling techniques must be applied. See MT-031 Tutorial, MT-101 Tutorial, and the A Practical Guide to High-Speed Printed-Circuit-Board Layout article for more detailed information regarding PCB layout. In addition, there are layout guidelines within the ADA4817-2 datasheet and the ADA4830-1 data sheet.

Circuit Performance

The four most important parameters of this composite circuit, CMR, -3 dB bandwidth, input referred noise, and harmonic distortion, are tested, and the results are shown in Figure 3 to Figure 6.

Figure 3 shows that the CMR of the composite circuit is -65 dB at dc and -55 dB at 10 MHz. Figure 4 shows that the bandwidth is 35 MHz at a gain of 5 and an output load of 100Ω . Figure 5 shows that the composite circuit only has 10 nV/ $\sqrt{\text{Hz}}$ input-referred noise at 100 kHz and a flatband noise of 8 nV/ $\sqrt{\text{Hz}}$ at higher frequencies. Figure 6 shows that the circuit has a THD of 60 dBc at 10 MHz, with $V_{OUT} = 1$ V p-p and $R_L = 1$ k Ω .

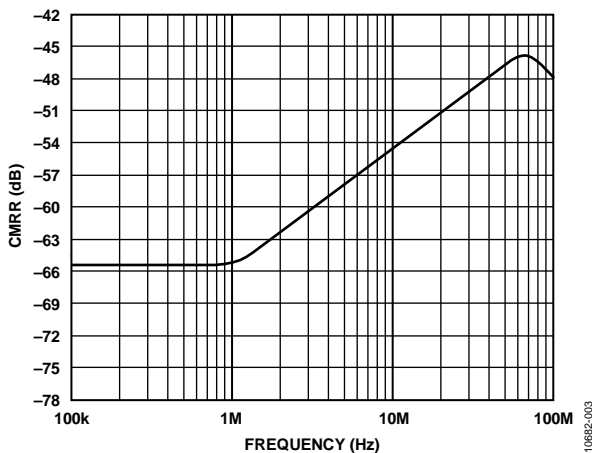

Figure 3. CMR of the CN-0273

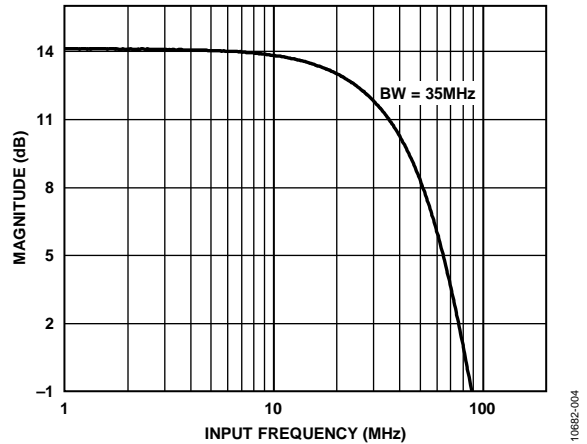

Figure 4. Frequency Response of Composite Circuit, $V_{OUT} = 1$ V p-p, $R_L = 100 \Omega$

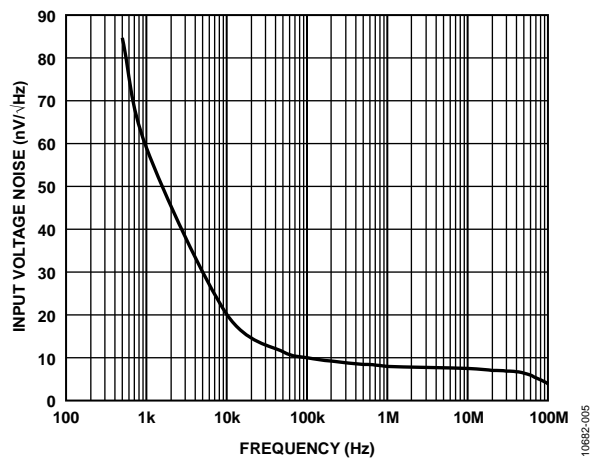

Figure 5. Input Referred Voltage Noise of Composite Circuit

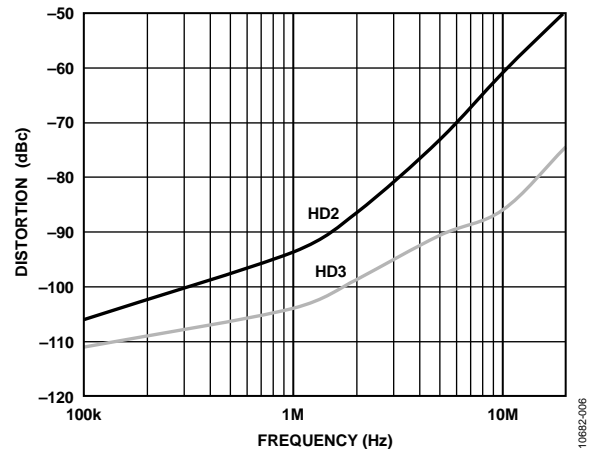

Figure 6. Second (HD2) and Third (HD3) Harmonic Distortion, $V_{OUT} = 1$ V p-p, $R_L = 1$ k Ω

COMMON VARIATIONS

The overall gain of this circuit can be easily configured by the value of the gain resistor, R_G , shown in Figure 1. Note that with a larger overall gain, the bandwidth of this circuit decreases.

The difference amplifier at the second stage can be replaced by the [AD8274](#) in lower speed applications. The [AD8274](#) difference amplifier offers a fixed gain of 2. Therefore, a larger overall gain can be achieved.

To increase the input common-mode and differential range, a rail-to-rail high speed FET input amplifier, such as the [AD8065/AD8066](#) that operates on ± 12 V supplies and has a unity-gain bandwidth of 145 MHz, can be used.

CIRCUIT EVALUATION AND TEST

The circuit can be easily evaluated using a signal generator and an oscilloscope. The board is tested with traditional amplifier test methods using a network analyzer. For complete schematics and PCB layout, refer to the [CN0273-Design Support package](#). A photo of the board is shown in Figure 7.

Note that the CMRR data in Figure 3 was taken for a differential input voltage of 0 V. The bandwidth data in Figure 4 and the distortion data in Figure 6 were taken using a balanced differential drive source with a common-mode voltage of 0 V.

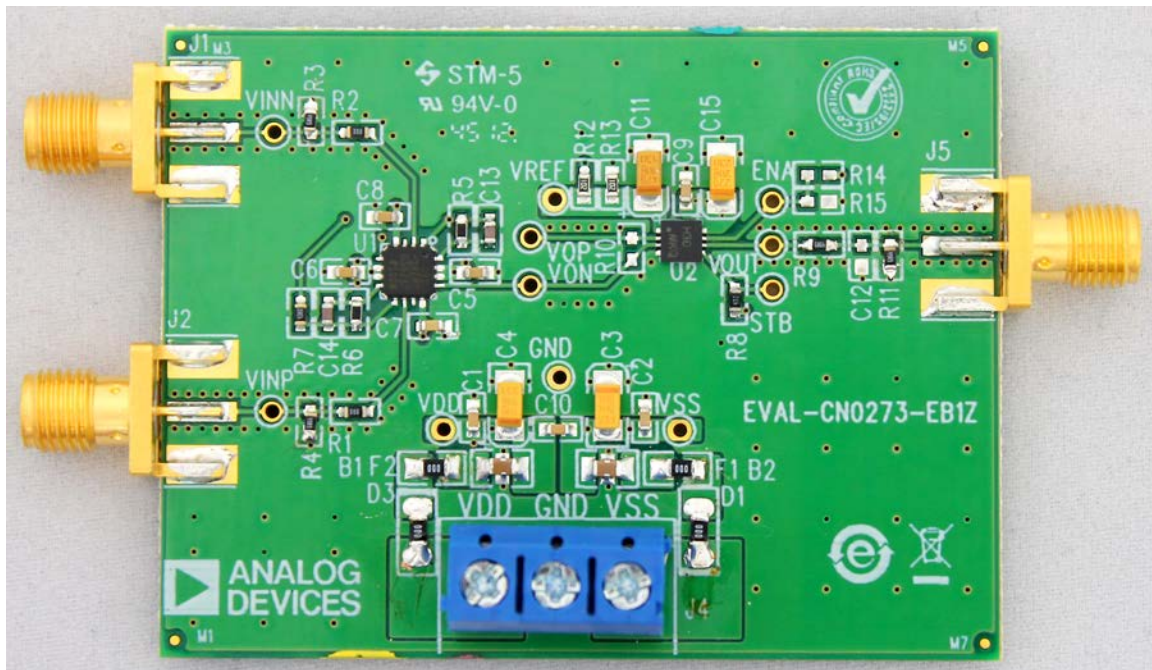

Figure 7. Photo of the [EVAL-CN0273-EB1Z](#) Evaluation Board

LEARN MORE

CN-0273 Design Support package:

<http://www.analog.com/CN0273-DesignSupport>

Ardizzoni, John. *A Practical Guide to High-Speed Printed-Circuit-Board Layout*, Analog Dialogue 39-09, September 2005.

MT-031 Tutorial, *Grounding Data Converters and Solving the Mystery of "AGND" and "DGND"*, Analog Devices.

MT-061 Tutorial, *Instrumentation Amplifier (In-Amp) Basics*, Analog Devices.

MT-063 Tutorial, *Basic Three Op Amp In-Amp Configurations*, Analog Devices.

MT-064 Tutorial, *In-Amp DC Sources*, Analog Devices.

MT-068 Tutorial, *Difference and Current Sense Amplifiers*, Analog Devices.

MT-101 Tutorial, *Decoupling Techniques*, Analog Devices.

A Designer's Guide to Instrumentation Amplifiers, Analog Devices.

Data Sheets and Evaluation Boards

[CN-0273 Circuit Evaluation Board \(EVAL-CN0273-EB1Z\)](#)

[ADA4817-2 Data Sheet](#)

[ADA4830-1 Data Sheet](#)

REVISION HISTORY

8/13—Rev. A to Rev. B

Changes to Figure 7 4

5/13—Rev. 0 to Rev. A

Changes to Circuit Evaluation and Test Section 4

10/12—Rev. 0: Initial Version

(Continued from first page) Circuits from the Lab circuits are intended only for use with Analog Devices products and are the intellectual property of Analog Devices or its licensors. While you may use the Circuits from the Lab circuits in the design of your product, no other license is granted by implication or otherwise under any patents or other intellectual property by application or use of the Circuits from the Lab circuits. Information furnished by Analog Devices is believed to be accurate and reliable. However, Circuits from the Lab circuits are supplied "as is" and without warranties of any kind, express, implied, or statutory including, but not limited to, any implied warranty of merchantability, noninfringement or fitness for a particular purpose and no responsibility is assumed by Analog Devices for their use, nor for any infringements of patents or other rights of third parties that may result from their use. Analog Devices reserves the right to change any Circuits from the Lab circuits at any time without notice but is under no obligation to do so.

©2012–2013 Analog Devices, Inc. All rights reserved. Trademarks and registered trademarks are the property of their respective owners.
CN10682-0-8/13(B)



Компания «Океан Электроники» предлагает заключение долгосрочных отношений при поставках импортных электронных компонентов на взаимовыгодных условиях!

Наши преимущества:

- Поставка оригинальных импортных электронных компонентов напрямую с производств Америки, Европы и Азии, а так же с крупнейших складов мира;
- Широкая линейка поставок активных и пассивных импортных электронных компонентов (более 30 млн. наименований);
- Поставка сложных, дефицитных, либо снятых с производства позиций;
- Оперативные сроки поставки под заказ (от 5 рабочих дней);
- Экспресс доставка в любую точку России;
- Помощь Конструкторского Отдела и консультации квалифицированных инженеров;
- Техническая поддержка проекта, помощь в подборе аналогов, поставка прототипов;
- Поставка электронных компонентов под контролем ВП;
- Система менеджмента качества сертифицирована по Международному стандарту ISO 9001;
- При необходимости вся продукция военного и аэрокосмического назначения проходит испытания и сертификацию в лаборатории (по согласованию с заказчиком);
- Поставка специализированных компонентов военного и аэрокосмического уровня качества (Xilinx, Altera, Analog Devices, Intersil, Interpoint, Microsemi, Actel, Aeroflex, Peregrine, VPT, Syfer, Eurofarad, Texas Instruments, MS Kennedy, Miteq, Cobham, E2V, MA-COM, Hittite, Mini-Circuits, General Dynamics и др.);

Компания «Океан Электроники» является официальным дистрибьютором и эксклюзивным представителем в России одного из крупнейших производителей разъемов военного и аэрокосмического назначения «JONHON», а так же официальным дистрибьютором и эксклюзивным представителем в России производителя высокотехнологичных и надежных решений для передачи СВЧ сигналов «FORSTAR».



JONHON

«JONHON» (основан в 1970 г.)

Разъемы специального, военного и аэрокосмического назначения:

(Применяются в военной, авиационной, аэрокосмической, морской, железнодорожной, горно- и нефтедобывающей отраслях промышленности)

«FORSTAR» (основан в 1998 г.)

ВЧ соединители, коаксиальные кабели,
кабельные сборки и микроволновые компоненты:

(Применяются в телекоммуникациях гражданского и специального назначения, в средствах связи, РЛС, а так же военной, авиационной и аэрокосмической отраслях промышленности).



Телефон: 8 (812) 309-75-97 (многоканальный)

Факс: 8 (812) 320-03-32

Электронная почта: ocean@oceanchips.ru

Web: <http://oceanchips.ru/>

Адрес: 198099, г. Санкт-Петербург, ул. Калинина, д. 2, корп. 4, лит. А