

# 7WBD3306

## 2-Bit Translating Bus Switch

The 7WBD3306 is an advanced high-speed low-power 2-bit translating bus switch in ultra-small footprints.

### Features











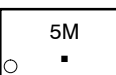

- High Speed:  $t_{PD} = 0.25$  ns (Max) @  $V_{CC} = 4.5$  V
- $3 \Omega$  Switch Connection Between 2 Ports
- Power Down Protection Provided on Inputs
- Zero Bounce
- TTL-Compatible Control Inputs
- Ultra-Small Pb-Free Packages
- These are Pb-Free Devices

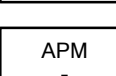

**ON Semiconductor®**

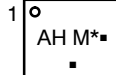
<http://onsemi.com>

### MARKING DIAGRAMS

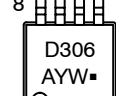
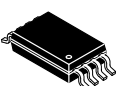
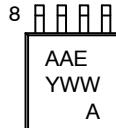
	<b>UDFN8</b> MU SUFFIX CASE 517AJ	
	<b>ULLGA8</b> 1.45 x 1.0 CASE 613AA	
	<b>ULLGA8</b> 1.6 x 1.0 CASE 613AB	
	<b>ULLGA8</b> 1.95 x 1.0 CASE 613AC	
	<b>UQFN8</b> MU SUFFIX CASE 523AN	
	<b>US8</b> US SUFFIX CASE 493	
	<b>Micro8™</b> DM SUFFIX CASE 846A	
	<b>TSSOP8</b> DT SUFFIX CASE 948AL	

A = Assembly Location  
 Y = Year  
 W = Work Week  
 M = Date Code  
 ■ = Pb-Free Package

(Note: Microdot may be in either location)

\*Date Code orientation may vary depending upon manufacturing location.

This document contains information on some products that are still under development. ON Semiconductor reserves the right to change or discontinue these products without notice.

### ORDERING INFORMATION

See detailed ordering and shipping information in the package dimensions section on page 6 of this data sheet.

# 7WBD3306

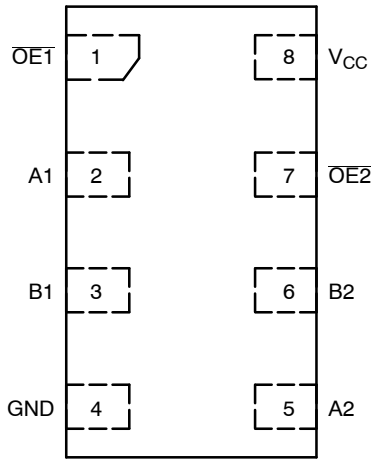

**Figure 1. ULLGA8/UDFN8**  
(Top Thru-View)

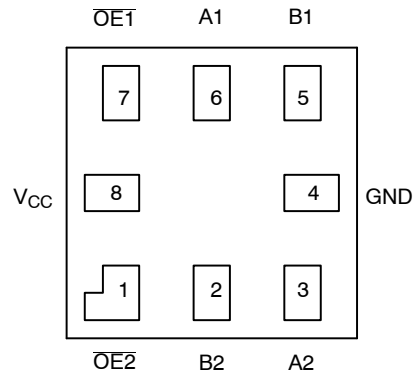

**Figure 2. UQFN8**  
(Top Thru-View)

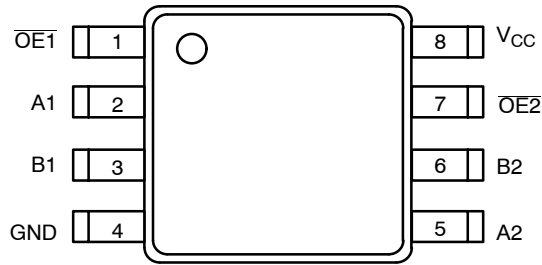

**Figure 3. US8/Micro8/TSSOP8**  
(Top View)

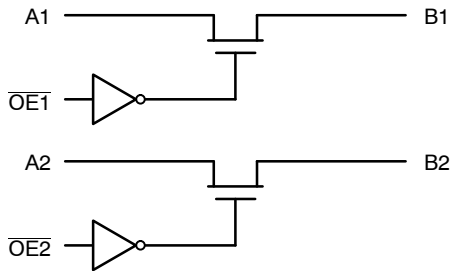

**Figure 4. Logic Diagram**

## FUNCTION TABLE

Input $\overline{OE}n$	Function
L	$Bn = An$
H	Disconnect

## MAXIMUM RATINGS

Symbol	Parameter	Value	Unit
V <sub>CC</sub>	DC Supply Voltage	-0.5 to +7.0	V
V <sub>IN</sub>	Control Pin Input Voltage	-0.5 to +7.0	V
V <sub>I/O</sub>	Switch Input / Output Voltage	-0.5 to +7.0	V
I <sub>IK</sub>	Control Pin DC Input Diode Current V <sub>IN</sub> < GND	-50	mA
I <sub>OK</sub>	Switch I/O Port DC Diode Current V <sub>I/O</sub> < GND	-50	mA
I <sub>O</sub>	ON-State Switch Current	± 128	mA
	Continuous Current Through V <sub>CC</sub> or GND	± 150	mA
I <sub>CC</sub>	DC Supply Current Per Supply Pin	± 150	mA
I <sub>GND</sub>	DC Ground Current per Ground Pin	± 150	mA
T <sub>STG</sub>	Storage Temperature Range	-65 to +150	°C
T <sub>L</sub>	Lead Temperature, 1 mm from Case for 10 Seconds	260	°C
T <sub>J</sub>	Junction Temperature Under Bias	150	°C
θ <sub>JA</sub>	Thermal Resistance US8 (Note 1) UDFN8 UQFN8 ULLGA8 Micro8 TSSOP8	251	°C/W
		111	
		208	
		455	
		392	
		150	
P <sub>D</sub>	Power Dissipation in Still Air at 85°C US8 UDFN8 UQFN8 ULLGA8 Micro8 TSSOP8	498	mW
		1127	
		601	
		274	
		319	
		833	
MSL	Moisture Sensitivity	Level 1	
F <sub>R</sub>	Flammability Rating Oxygen Index: 28 to 34	UL 94 V-0 @ 0.125 in	
V <sub>ESD</sub>	ESD Withstand Voltage Human Body Mode (Note 2) Machine Model (Note 3) Charged Device Model (Note 4)	> 2000	V
		> 200	
		N/A	
I <sub>LATCHUP</sub>	Latchup Performance Above V <sub>CC</sub> and Below GND at 125°C (Note 5)	± 200	mA

Stresses exceeding Maximum Ratings may damage the device. Maximum Ratings are stress ratings only. Functional operation above the Recommended Operating Conditions is not implied. Extended exposure to stresses above the Recommended Operating Conditions may affect device reliability.

1. Measured with minimum pad spacing on an FR4 board, using 10 mm-by-1 inch, 2 ounce copper trace no air flow.
2. Tested to EIA / JESD22-A114-A.
3. Tested to EIA / JESD22-A115-A.
4. Tested to JESD22-C101-A.
5. Tested to EIA / JESD78.

## RECOMMENDED OPERATING CONDITIONS

Symbol	Parameter	Min	Max	Unit
V <sub>CC</sub>	Positive DC Supply Voltage	4.0	5.5	V
V <sub>IN</sub>	Control Pin Input Voltage	0	5.5	V
V <sub>I/O</sub>	Switch Input / Output Voltage	0	5.5	V
T <sub>A</sub>	Operating Free-Air Temperature	-55	+125	°C
Δt / ΔV	Input Transition Rise or Fall Rate Control Input Switch I/O	0	5	nS/V
		0	DC	

# 7WBD3306

## DC ELECTRICAL CHARACTERISTICS

Symbol	Parameter	Conditions	V <sub>CC</sub> (V)	T <sub>A</sub> = 25°C			T <sub>A</sub> = -55°C to +125°C		Unit
				Min	Typ	Max	Min	Max	
V <sub>IK</sub>	Clamp Diode Voltage	I <sub>I/O</sub> = -18 mA	4.5			-1.2		-1.2	V
V <sub>IH</sub>	High-Level Input Voltage (Control)		4.0 to 5.5	2.0			2.0		V
V <sub>IL</sub>	Low-Level Input Voltage (Control)		4.0 to 5.5			0.8		0.8	V
V <sub>OH</sub>	Output Voltage High	See Figure 5							
I <sub>IN</sub>	Input Leakage Current	0 ≤ V <sub>IN</sub> ≤ 5.5 V	5.5			±0.1		±1.0	μA
I <sub>OFF</sub>	Power Off Leakage Current	V <sub>I/O</sub> = 0 to 5.5 V	0			±0.1		±1.0	μA
I <sub>CC</sub>	Quiescent Supply Current	I <sub>O</sub> = 0, V <sub>IN</sub> = V <sub>CC</sub> or 0 V OE1 = OE2 = GND OE1 = OE2 = V <sub>CC</sub>	5.5			±1.0 ±0.1		±1.0 ±1.0	mA μA
ΔI <sub>CC</sub>	Increase in Supply Current (Control Pin)	One input at 3.4 V; Other inputs at V <sub>CC</sub> or GND	5.5					2.5	mA
R <sub>ON</sub>	Switch ON Resistance	V <sub>I/O</sub> = 0, I <sub>I/O</sub> = 64 mA I <sub>I/O</sub> = 30 mA	4.5		3 3	7 7		7 7	Ω
		V <sub>I/O</sub> = 2.4, I <sub>I/O</sub> = 15 mA			15	50		50	
		V <sub>I/O</sub> = 2.4, I <sub>I/O</sub> = 15 mA	4.0		50	70		70	

## AC ELECTRICAL CHARACTERISTICS

Symbol	Parameter	Test Condition	V <sub>CC</sub> (V)	T <sub>A</sub> = 25 °C			T <sub>A</sub> = -55°C to +125°C		Unit
				Min	Typ	Max	Min	Max	
t <sub>PD</sub>	Propagation Delay, Bus to Bus	See Figure 6	4.0 to 5.5			0.25		0.25	ns
t <sub>EN</sub>	Output Enable Time	See Figure 6	4.5 to 5.5	0.8	2.5	4.2	0.8	4.2	ns
			4.0	0.8	3.0	4.6	0.8	4.6	
t <sub>DIS</sub>	Output Disable Time		4.5 to 5.5	0.8	3.0	4.8	0.8	4.8	ns
			4.0	0.8	2.9	4.4	0.8	4.4	
C <sub>IN</sub>	Control Input Capacitance	V <sub>IN</sub> = 5 or 0 V	5.0		2.5				pF
C <sub>IO(ON)</sub>	Switch On Capacitance	Switch ON	5.0		10				pF
C <sub>IO(OFF)</sub>	Switch Off Capacitance	Switch OFF	5.0		5				pF

# 7WBD3306

## TYPICAL DC CHARACTERISTICS

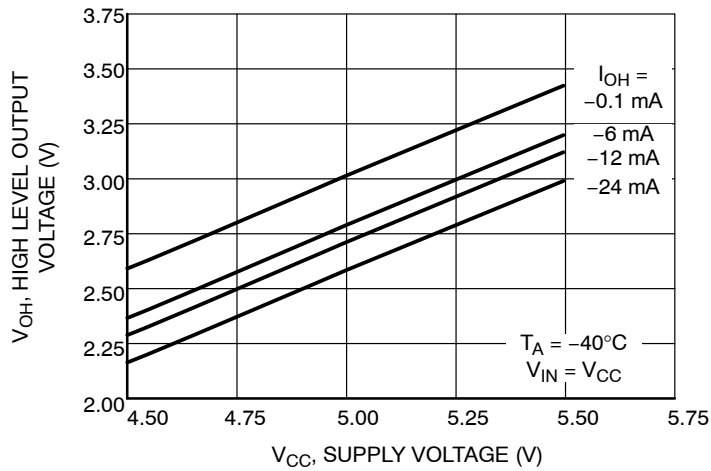
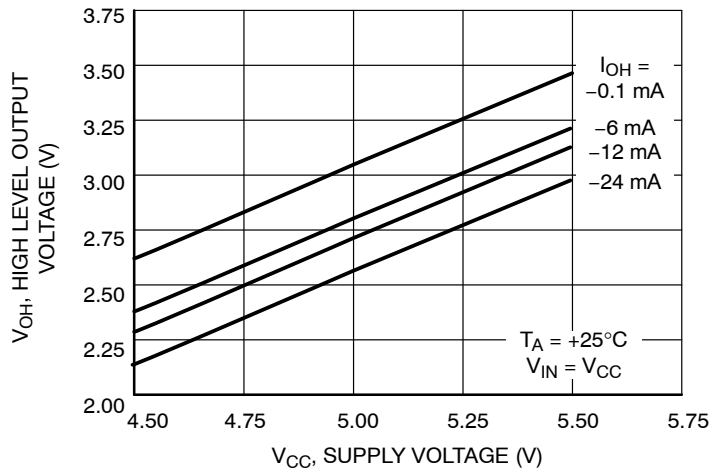
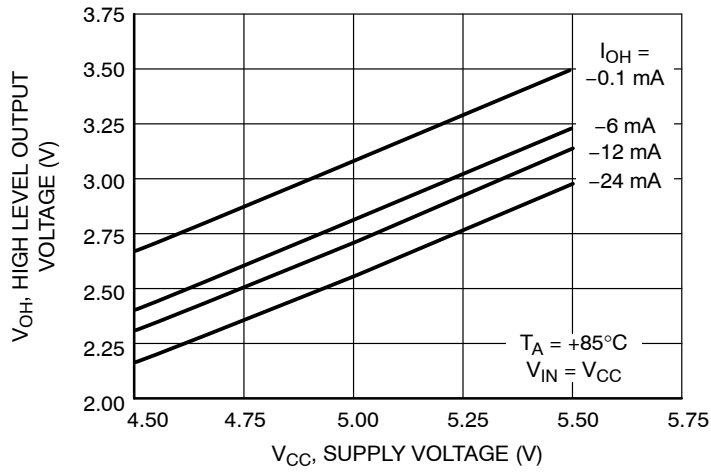

Figure 5. Output Voltage High vs Supply Voltage

# 7WBD3306

## AC LOADING AND WAVEFORMS

### Parameter Measurement Information



\* $C_L$  includes probes and jig capacitance.

Test	S1
$t_{PD}$	Open
$t_{PLZ}/t_{PZL}$	7 V
$t_{PHZ}/t_{PZH}$	Open

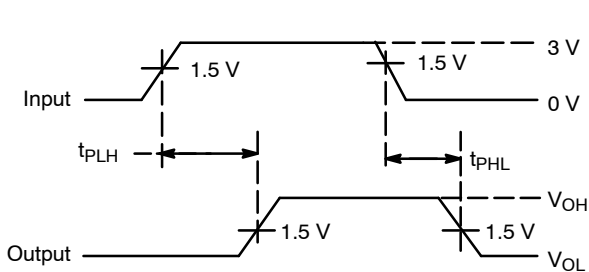

**Voltage Waveforms  
Propagation Delay Times**

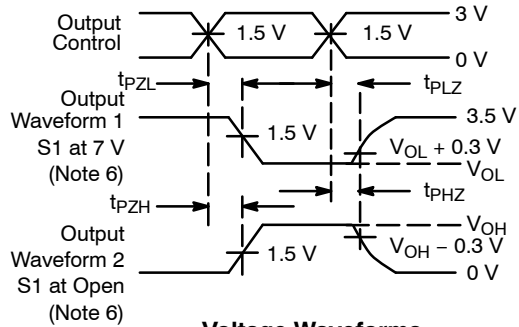

**Voltage Waveforms  
Enable and Disable Times**

- Waveform 1 is for an output with internal conditions such that the output is low, except when disabled by the output control. Waveform 2 is for an output with internal conditions such that the output is high, except when disabled by the output control.
- All input pulses are supplied by generators having the following characteristics:  $PRR \leq 10 \text{ MHz}$ ,  $Z_O = 50 \Omega$ ,  $t_r \leq 2.5 \text{ ns}$ ,  $t_f \leq 2.5 \text{ ns}$ .
- The outputs are measured one at a time, with one transition per measurement.
- $t_{PLZ}$  and  $t_{PHZ}$  are the same as  $t_{DIS}$ .
- $t_{PZL}$  and  $t_{PZH}$  are the same as  $t_{EN}$ .
- $t_{PHL}$  and  $t_{PLH}$  are the same as  $t_{PD}$ .

**Figure 6.  $t_{PD}$ ,  $t_{EN}$ ,  $t_{DIS}$  Loading and Waveforms**

### ORDERING INFORMATION

Device	Package	Shipping†
7WBD3306USG	US8 (Pb-Free)	3000 / Tape & Reel
7WBD3306MUTAG	UDFN8 (Pb-Free)	3000 / Tape & Reel
7WBD3306AMUTCG	UQFN8 (Pb-Free)	3000 / Tape & Reel
7WBD3306AMX1TCG	ULLGA8 – 0.5 mm Pitch (Pb-Free)	3000 / Tape & Reel
7WBD3306BMX1TCG	ULLGA8 – 0.4 mm Pitch (Pb-Free)	3000 / Tape & Reel
7WBD3306CMX1TCG	ULLGA8 – 0.35 mm Pitch (Pb-Free)	3000 / Tape & Reel
7WBD3306DMR2G	Micro8 (Pb-Free)	4000 / Tape & Reel (In Development)
7WBD3306DTR2G	TSSOP8 (Pb-Free)	4000 / Tape & Reel

†For information on tape and reel specifications, including part orientation and tape sizes, please refer to our Tape and Reel Packaging Specifications Brochure, BRD8011/D.

# 7WBD3306

## PACKAGE DIMENSIONS

UDFN8 1.8 x 1.2, 0.4P  
CASE 517AJ-01  
ISSUE O

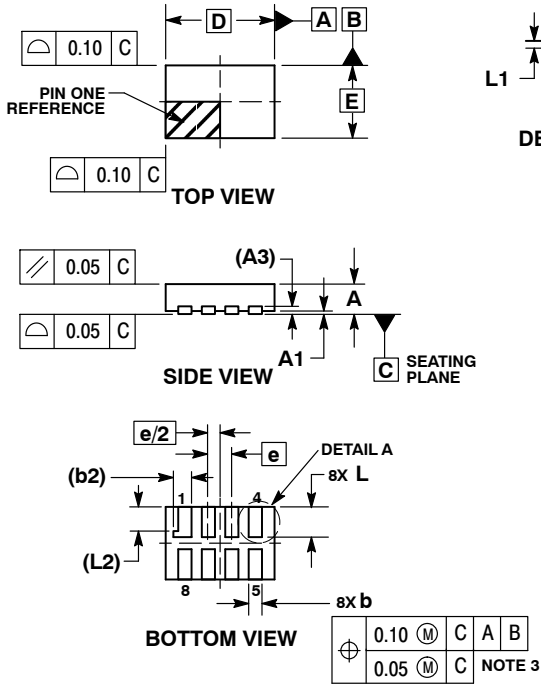

**NOTES:**

1. DIMENSIONING AND TOLERANCING PER ASME Y14.5M, 1994.
2. CONTROLLING DIMENSION: MILLIMETERS.
3. DIMENSION b APPLIES TO PLATED TERMINAL AND IS MEASURED BETWEEN 0.15 AND 0.30 mm FROM TERMINAL TIP.
4. MOLD FLASH ALLOWED ON TERMINALS ALONG EDGE OF PACKAGE. FLASH MAY NOT EXCEED 0.03 ONTO BOTTOM SURFACE OF TERMINALS.
5. DETAIL A SHOWS OPTIONAL CONSTRUCTION FOR TERMINALS.

MILLIMETERS		
DIM	MIN	MAX
A	0.45	0.55
A1	0.00	0.05
A3	0.127	REF
b	0.15	0.25
b2	0.30	REF
D	1.80	BSC
E	1.20	BSC
e	0.40	BSC
L	0.45	0.55
L1	0.00	0.03
L2	0.40	REF

**MOUNTING FOOTPRINT\*  
SOLDERMASK DEFINED**

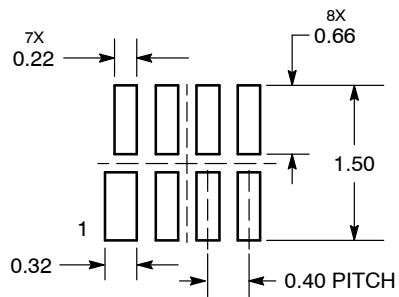

DIMENSIONS: MILLIMETERS

\*For additional information on our Pb-Free strategy and soldering details, please download the ON Semiconductor Soldering and Mounting Techniques Reference Manual, SOLDERRM/D.

# 7WBD3306

## PACKAGE DIMENSIONS

ULLGA8 1.45x1.0, 0.35P  
CASE 613AA-01  
ISSUE A

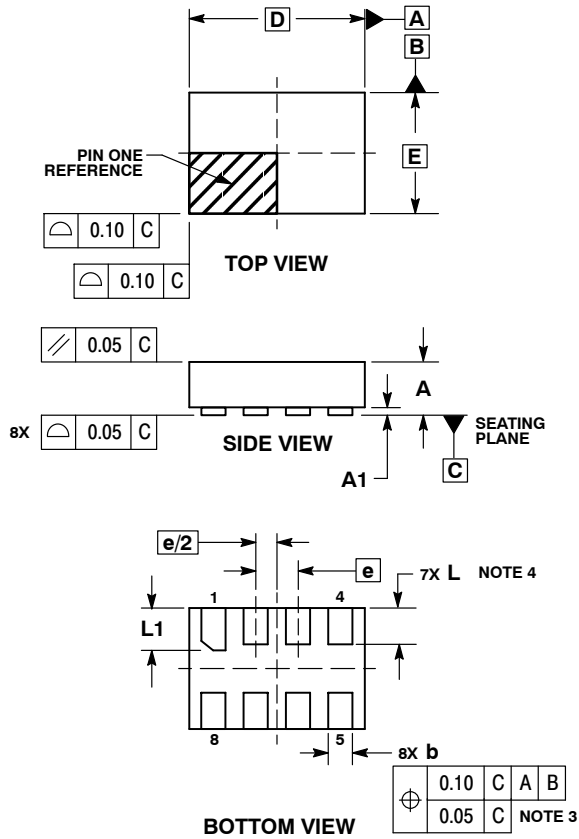

**NOTES:**

1. DIMENSIONING AND TOLERANCING PER ASME Y14.5M, 1994.
2. CONTROLLING DIMENSION: MILLIMETERS.
3. DIMENSION b APPLIES TO PLATED TERMINAL AND IS MEASURED BETWEEN 0.15 AND 0.30 mm FROM THE TERMINAL TIP.
4. A MAXIMUM OF 0.05 PULL BACK OF THE PLATED TERMINAL FROM THE EDGE OF THE PACKAGE IS ALLOWED.

MILLIMETERS		
DIM	MIN	MAX
A	---	0.40
A1	0.00	0.05
b	0.15	0.25
D	1.45 BSC	
E	1.00 BSC	
e	0.35 BSC	
L	0.25	0.35
L1	0.30	0.40

**MOUNTING FOOTPRINT  
SOLDERMASK DEFINED\***

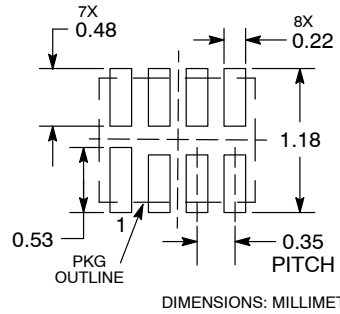

\*For additional information on our Pb-Free strategy and soldering details, please download the ON Semiconductor Soldering and Mounting Techniques Reference Manual, SOLDERRM/D.



# 7WBD3306

## PACKAGE DIMENSIONS

ULLGA8 1.6x1.0, 0.4P  
CASE 613AB-01  
ISSUE A

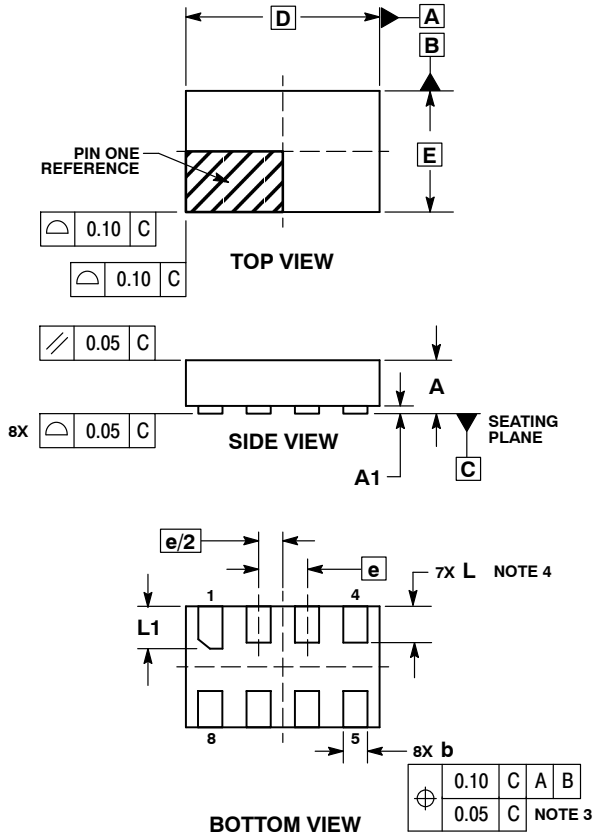

**NOTES:**

1. DIMENSIONING AND TOLERANCING PER ASME Y14.5M, 1994.
2. CONTROLLING DIMENSION: MILLIMETERS.
3. DIMENSION b APPLIES TO PLATED TERMINAL AND IS MEASURED BETWEEN 0.15 AND 0.30 mm FROM THE TERMINAL TIP.
4. A MAXIMUM OF 0.05 PULL BACK OF THE PLATED TERMINAL FROM THE EDGE OF THE PACKAGE IS ALLOWED.

MILLIMETERS		
DIM	MIN	MAX
A	---	0.40
A1	0.00	0.05
b	0.15	0.25
D	1.60 BSC	
E	1.00 BSC	
e	0.40 BSC	
L	0.25	0.35
L1	0.30	0.40

**MOUNTING FOOTPRINT  
SOLDERMASK DEFINED\***

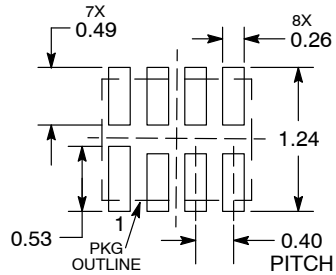

DIMENSIONS: MILLIMETERS

\*For additional information on our Pb-Free strategy and soldering details, please download the ON Semiconductor Soldering and Mounting Techniques Reference Manual, SOLDERRM/D.

# 7WBD3306

## PACKAGE DIMENSIONS

ULLGA8 1.95x1.0, 0.5P  
CASE 613AC-01  
ISSUE A

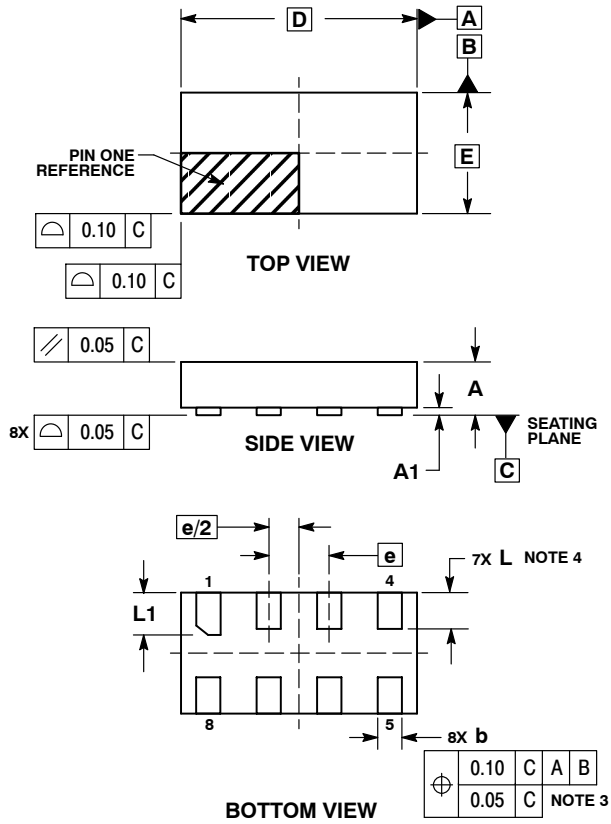

**NOTES:**

1. DIMENSIONING AND TOLERANCING PER ASME Y14.5M, 1994.
2. CONTROLLING DIMENSION: MILLIMETERS.
3. DIMENSION b APPLIES TO PLATED TERMINAL AND IS MEASURED BETWEEN 0.15 AND 0.30 mm FROM THE TERMINAL TIP.
4. A MAXIMUM OF 0.05 PULL BACK OF THE PLATED TERMINAL FROM THE EDGE OF THE PACKAGE IS ALLOWED.

MILLIMETERS		
DIM	MIN	MAX
A	---	0.40
A1	0.00	0.05
b	0.15	0.25
D	1.95 BSC	
E	1.00 BSC	
e	0.50 BSC	
L	0.25	0.35
L1	0.30	0.40

**MOUNTING FOOTPRINT  
SOLDERMASK DEFINED\***



DIMENSIONS: MILLIMETERS

\*For additional information on our Pb-Free strategy and soldering details, please download the ON Semiconductor Soldering and Mounting Techniques Reference Manual, SOLDERRM/D.

# 7WBD3306

## PACKAGE DIMENSIONS

### UQFN8, 1.6x1.6, 0.5P CASE 523AN-01 ISSUE O

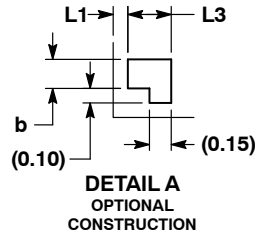
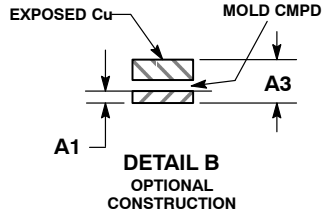
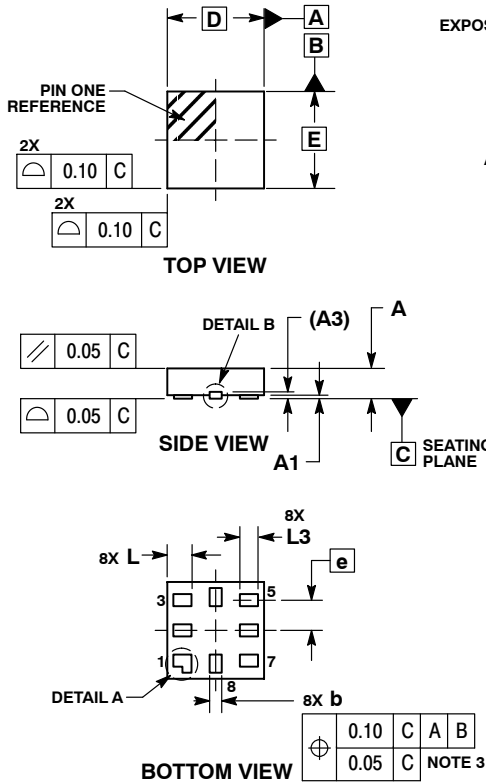

**NOTES:**

1. DIMENSIONING AND TOLERANCING PER ASME Y14.5M, 1994.
2. CONTROLLING DIMENSION: MILLIMETERS.
3. DIMENSION b APPLIES TO PLATED TERMINAL AND IS MEASURED BETWEEN 0.15 AND 0.30 mm FROM THE TERMINAL TIP.

MILLIMETERS		
DIM	MIN	MAX
A	0.45	0.60
A1	0.00	0.05
A3	0.13	REF
b	0.15	0.25
D	1.60	BSC
E	1.60	BSC
e	0.50	BSC
L	0.35	0.45
L1	---	0.15
L3	0.25	0.35

### SOLDERING FOOTPRINT\*

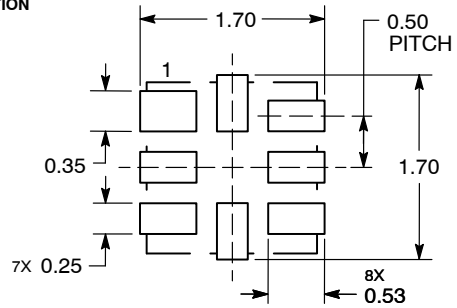

DIMENSIONS: MILLIMETERS

\*For additional information on our Pb-Free strategy and soldering details, please download the ON Semiconductor Soldering and Mounting Techniques Reference Manual, SOLDERRM/D.

# 7WBD3306

## PACKAGE DIMENSIONS

US8  
CASE 493-02  
ISSUE B

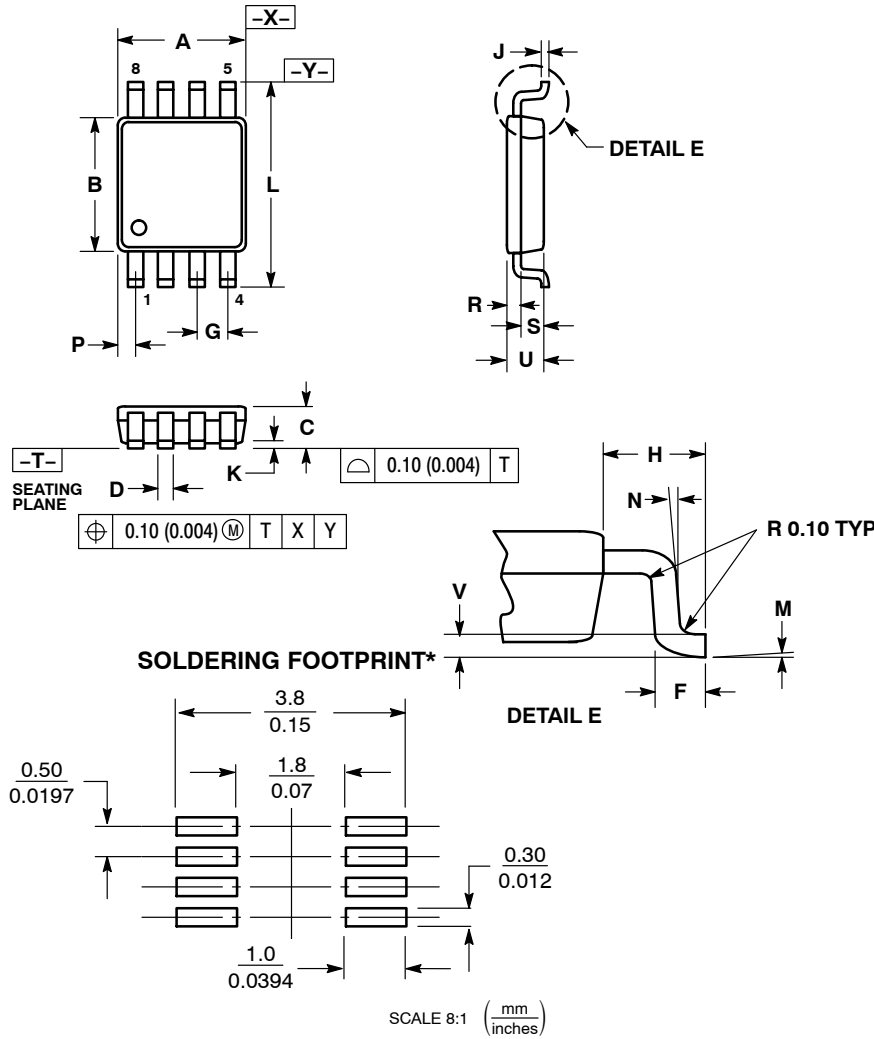

NOTES:

1. DIMENSIONING AND TOLERANCING PER ANSI Y14.5M, 1982.
2. CONTROLLING DIMENSION: MILLIMETERS.
3. DIMENSION "A" DOES NOT INCLUDE MOLD FLASH, PROTRUSION OR GATE BURR. MOLD FLASH, PROTRUSION AND GATE BURR SHALL NOT EXCEED 0.140 MM (0.0055") PER SIDE.
4. DIMENSION "B" DOES NOT INCLUDE INTER-LEAD FLASH OR PROTRUSION. INTER-LEAD FLASH AND PROTRUSION SHALL NOT EXCEED 0.140 (0.0055") PER SIDE.
5. LEAD FINISH IS SOLDER PLATING WITH THICKNESS OF 0.0076-0.0203 MM. (300-800 μ).
6. ALL TOLERANCE UNLESS OTHERWISE SPECIFIED ±0.0508 (0.0020").

DIM	MILLIMETERS		INCHES	
	MIN	MAX	MIN	MAX
A	1.90	2.10	0.075	0.083
B	2.20	2.40	0.087	0.094
C	0.60	0.90	0.024	0.035
D	0.17	0.25	0.007	0.010
F	0.20	0.35	0.008	0.014
G	0.50 BSC		0.020 BSC	
H	0.40 REF		0.016 REF	
J	0.10	0.18	0.004	0.007
K	0.00	0.10	0.000	0.004
L	3.00	3.20	0.118	0.126
M	0°	6°	0°	6°
N	5°	10°	5°	10°
P	0.23	0.34	0.010	0.013
R	0.23	0.33	0.009	0.013
S	0.37	0.47	0.015	0.019
U	0.60	0.80	0.024	0.031
V	0.12 BSC		0.005 BSC	

\*For additional information on our Pb-Free strategy and soldering details, please download the ON Semiconductor Soldering and Mounting Techniques Reference Manual, SOLDERRM/D.

# 7WBD3306

## PACKAGE DIMENSIONS

Micro8™  
CASE 846A-02  
ISSUE H

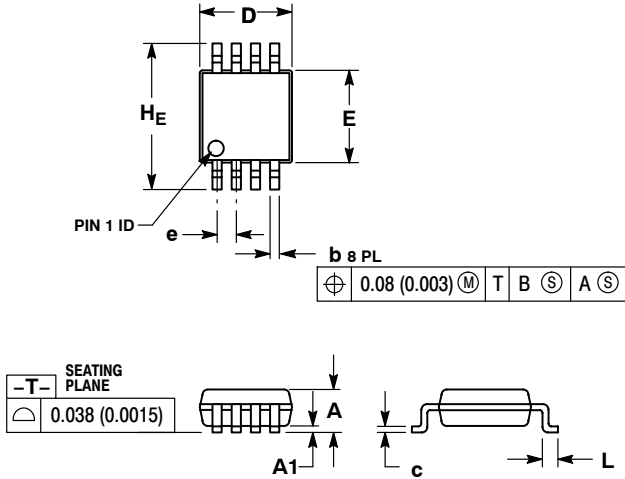

NOTES:

1. DIMENSIONING AND TOLERANCING PER ANSI Y14.5M, 1982.
2. CONTROLLING DIMENSION: MILLIMETER.
3. DIMENSION A DOES NOT INCLUDE MOLD FLASH, PROTRUSIONS OR GATE BURRS. MOLD FLASH, PROTRUSIONS OR GATE BURRS SHALL NOT EXCEED 0.15 (0.006) PER SIDE.
4. DIMENSION B DOES NOT INCLUDE INTERLEAD FLASH OR PROTRUSION. INTERLEAD FLASH OR PROTRUSION SHALL NOT EXCEED 0.25 (0.010) PER SIDE.
5. 846A-01 OBSOLETE, NEW STANDARD 846A-02.

DIM	MILLIMETERS			INCHES		
	MIN	NOM	MAX	MIN	NOM	MAX
A	--	--	1.10	--	--	0.043
A1	0.05	0.08	0.15	0.002	0.003	0.006
b	0.25	0.33	0.40	0.010	0.013	0.016
c	0.13	0.18	0.23	0.005	0.007	0.009
D	2.90	3.00	3.10	0.114	0.118	0.122
E	2.90	3.00	3.10	0.114	0.118	0.122
e	0.65 BSC			0.026 BSC		
L	0.40	0.55	0.70	0.016	0.021	0.028
HE	4.75	4.90	5.05	0.187	0.193	0.199

### SOLDERING FOOTPRINT\*

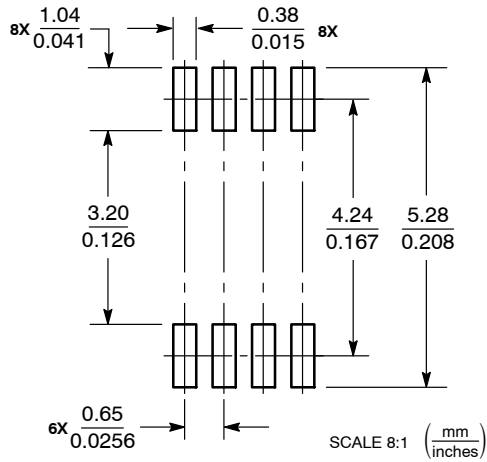

\*For additional information on our Pb-Free strategy and soldering details, please download the ON Semiconductor Soldering and Mounting Techniques Reference Manual, SOLDERRM/D.

# 7WBD3306

## PACKAGE DIMENSIONS

TSSOP8, 4.4x3  
CASE 948AL-01  
ISSUE O

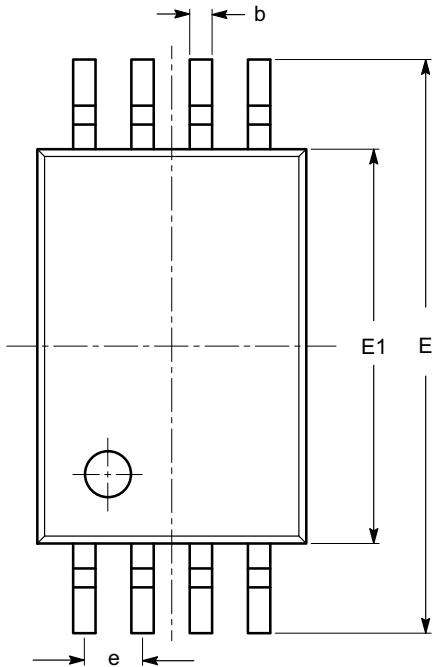

SYMBOL	MIN	NOM	MAX
A			1.20
A1	0.05		0.15
A2	0.80	0.90	1.05
b	0.19		0.30
c	0.09		0.20
D	2.90	3.00	3.10
E	6.30	6.40	6.50
E1	4.30	4.40	4.50
e	0.65 BSC		
L	1.00 REF		
L1	0.50	0.60	0.75
$\theta$	0°		8°

TOP VIEW

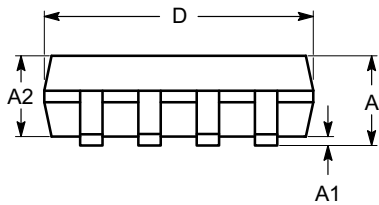

SIDE VIEW

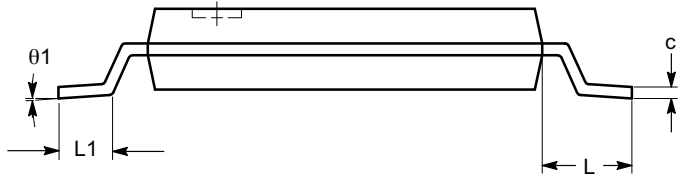

END VIEW

### Notes:

- (1) All dimensions are in millimeters. Angles in degrees.
- (2) Complies with JEDEC MO-153.

Micro8 is a trademark of International Rectifier.

ON Semiconductor and  are registered trademarks of Semiconductor Components Industries, LLC (SCILLC). SCILLC reserves the right to make changes without further notice to any products herein. SCILLC makes no warranty, representation or guarantee regarding the suitability of its products for any particular purpose, nor does SCILLC assume any liability arising out of the application or use of any product or circuit, and specifically disclaims any and all liability, including without limitation special, consequential or incidental damages. "Typical" parameters which may be provided in SCILLC data sheets and/or specifications can and do vary in different applications and actual performance may vary over time. All operating parameters, including "Typicals" must be validated for each customer application by customer's technical experts. SCILLC does not convey any license under its patent rights nor the rights of others. SCILLC products are not designed, intended, or authorized for use as components in systems intended for surgical implant into the body, or other applications intended to support or sustain life, or for any other application in which the failure of the SCILLC product could create a situation where personal injury or death may occur. Should Buyer purchase or use SCILLC products for any such unintended or unauthorized application, Buyer shall indemnify and hold SCILLC and its officers, employees, subsidiaries, affiliates, and distributors harmless against all claims, costs, damages, and expenses, and reasonable attorney fees arising out of, directly or indirectly, any claim of personal injury or death associated with such unintended or unauthorized use, even if such claim alleges that SCILLC was negligent regarding the design or manufacture of the part. SCILLC is an Equal Opportunity/Affirmative Action Employer. This literature is subject to all applicable copyright laws and is not for resale in any manner.

### PUBLICATION ORDERING INFORMATION

**LITERATURE FULFILLMENT:**  
Literature Distribution Center for ON Semiconductor  
P.O. Box 5163, Denver, Colorado 80217 USA  
**Phone:** 303-675-2175 or 800-344-3860 Toll Free USA/Canada  
**Fax:** 303-675-2176 or 800-344-3867 Toll Free USA/Canada  
**Email:** orderlit@onsemi.com

**N. American Technical Support:** 800-282-9855 Toll Free  
USA/Canada  
**Europe, Middle East and Africa Technical Support:**  
Phone: 421 33 790 2910  
**Japan Customer Focus Center**  
Phone: 81-3-5773-3850

**ON Semiconductor Website:** [www.onsemi.com](http://www.onsemi.com)  
**Order Literature:** <http://www.onsemi.com/orderlit>  
For additional information, please contact your local Sales Representative

Компания «Океан Электроники» предлагает заключение долгосрочных отношений при поставках импортных электронных компонентов на взаимовыгодных условиях!

Наши преимущества:

- Поставка оригинальных импортных электронных компонентов напрямую с производств Америки, Европы и Азии, а так же с крупнейших складов мира;
- Широкая линейка поставок активных и пассивных импортных электронных компонентов (более 30 млн. наименований);
- Поставка сложных, дефицитных, либо снятых с производства позиций;
- Оперативные сроки поставки под заказ (от 5 рабочих дней);
- Экспресс доставка в любую точку России;
- Помощь Конструкторского Отдела и консультации квалифицированных инженеров;
- Техническая поддержка проекта, помощь в подборе аналогов, поставка прототипов;
- Поставка электронных компонентов под контролем ВП;
- Система менеджмента качества сертифицирована по Международному стандарту ISO 9001;
- При необходимости вся продукция военного и аэрокосмического назначения проходит испытания и сертификацию в лаборатории (по согласованию с заказчиком);
- Поставка специализированных компонентов военного и аэрокосмического уровня качества (Xilinx, Altera, Analog Devices, Intersil, Interpoint, Microsemi, Actel, Aeroflex, Peregrine, VPT, Syfer, Eurofarad, Texas Instruments, MS Kennedy, Miteq, Cobham, E2V, MA-COM, Hittite, Mini-Circuits, General Dynamics и др.);

Компания «Океан Электроники» является официальным дистрибьютором и эксклюзивным представителем в России одного из крупнейших производителей разъемов военного и аэрокосмического назначения «JONHON», а так же официальным дистрибьютором и эксклюзивным представителем в России производителя высокотехнологичных и надежных решений для передачи СВЧ сигналов «FORSTAR».



## JONHON

«JONHON» (основан в 1970 г.)

Разъемы специального, военного и аэрокосмического назначения:

(Применяются в военной, авиационной, аэрокосмической, морской, железнодорожной, горно- и нефтедобывающей отраслях промышленности)

«FORSTAR» (основан в 1998 г.)

ВЧ соединители, коаксиальные кабели,  
кабельные сборки и микроволновые компоненты:

(Применяются в телекоммуникациях гражданского и специального назначения, в средствах связи, РЛС, а так же военной, авиационной и аэрокосмической отраслях промышленности).



Телефон: 8 (812) 309-75-97 (многоканальный)

Факс: 8 (812) 320-03-32

Электронная почта: [ocean@oceanchips.ru](mailto:ocean@oceanchips.ru)

Web: <http://oceanchips.ru/>

Адрес: 198099, г. Санкт-Петербург, ул. Калинина, д. 2, корп. 4, лит. А