

LTM4608AEV: 8A Step-Down Power µModule® Regulator

DESCRIPTION

Demonstration circuit DC1400A features the LTM®4608AEV, the high efficiency, high density switch mode step-down power module. The input voltage range is 2.5V to 5.5V. The output voltage is jumper selectable from 0.6V to 3.3V. The rated load current is 8A although derating is necessary for certain V_{IN} , V_{OUT} and thermal conditions. LTM4608A offers a novel phase-shift clock output to support current sharing with other regulators. The TRACK/SS pin allows the user to program output voltage ramp-up and ramp-down slew rate. The same pin also allows the output to

coincidentally or ratiometrically track another voltage rail. The margining function is provided for users who wish to stress their systems by varying supply voltages during testing. The LTM4608A data sheet must be read in conjunction with this demo manual prior to working on or modifying the DC1400A

Design files for this circuit board are available at <http://www.linear.com/demo>

LT, LTC, LTM, µModule, Linear Technology and the Linear logo are registered trademarks of Linear Technology Corporation. All other trademarks are the property of their respective owners.

PERFORMANCE SUMMARY (T_A = 25°C)

PARAMETER	CONDITION	VALUE
Input Voltage Range		2.5V to 5.5V
Output Voltage Range	Jumper Selectable (Open for 0.6V)	1.2V, 1.5V, 1.8V, 2.5V, 3.3V; ±2%
Maximum Continuous Output Current	Derating is Necessary for Certain V_{IN} , V_{OUT} and Thermal Conditions	8A DC
Default Operating Frequency		1.5MHz
Efficiency	$V_{IN} = 5V$, $V_{OUT} = 2.5V$, $I_{OUT} = 8A$	84.5%, See Figure 3 for More Information

BOARD PHOTO

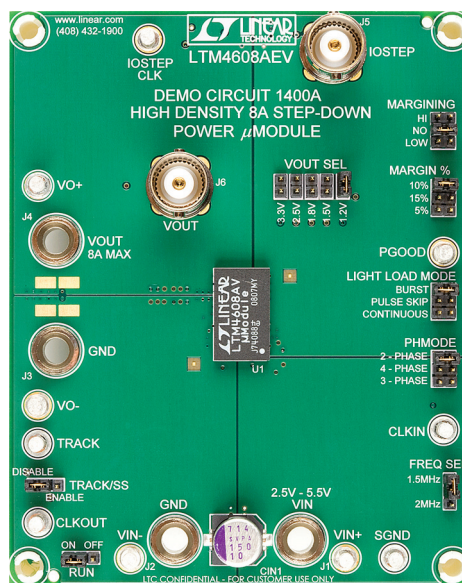

dc1400af

DEMO MANUAL DC1400A

QUICK START PROCEDURE

Demonstration circuit DC1400A is an easy way to evaluate the LTM4608AEV. Please refer to Figure 1 for proper measurement equipment setup and follow the procedure below:

1. Place jumpers in the following positions for a typical 1.2V_{OUT} application:

TRACK	RUN	V _{OUT} SELECT	MARGINING
DISABLE	ON	1.2V	NO

2. With power off, connect the input power supply, load and meters as shown in Figure 1. Preset the load to 0A and input power supply between 2.5V to 5.5V.
3. Turn on the power at the input. The output voltage should be 1.2V ±2%.
4. Once the proper output voltage is established, adjust the load within the operating range and observe the output voltage regulation, ripple voltage, efficiency and other parameters.

5. To measure the input and output ripple, please refer to Figure 2 for proper setup.
6. For an optional load transient test, apply an adjustable pulse signal between IOSTEP CLK and GND pins. The pulse amplitude sets the current step. The pulse signal should have very small duty cycle (<5%) to limit the thermal stress on the transient load circuit. The output current is best monitored with a BNC cable at J5 (10mV/A). The output voltage is best monitored with a BNC cable at J6.

Note: To disable margining in applications when V_{OUT} is close to V_{IN} (dropout mode), the MGN pin should be tied to a voltage rail equal to 50% of V_{IN} created by a resistor divider.

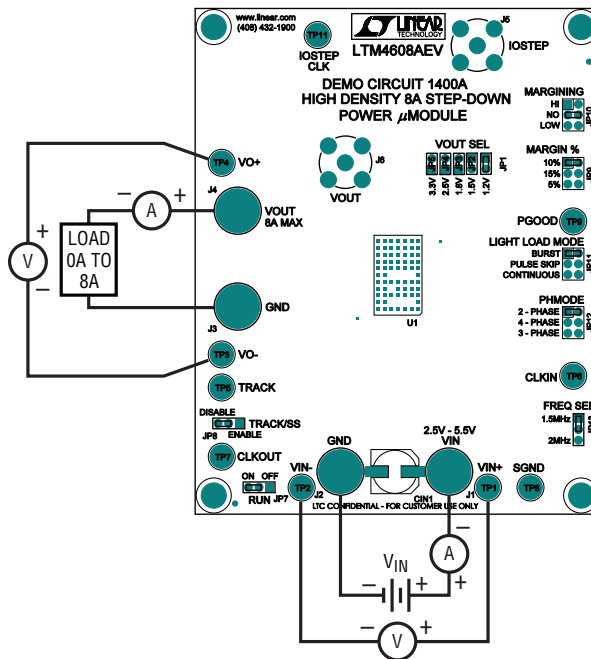

Figure 1. Test Setup of DC1400A

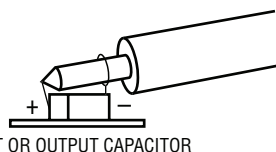
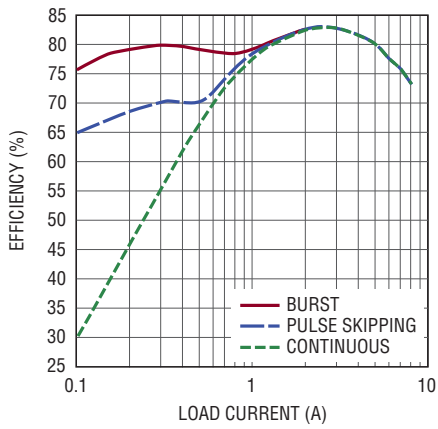

Figure 2. Proper Scope Probe Technique for Measuring Input or Output Ripple

QUICK START PROCEDURE

Efficiency vs Load Current with 5V_{IN}, 1.2V_{OUT}



Efficiency vs Load Current with 5V_{IN}, 1.5V_{OUT}

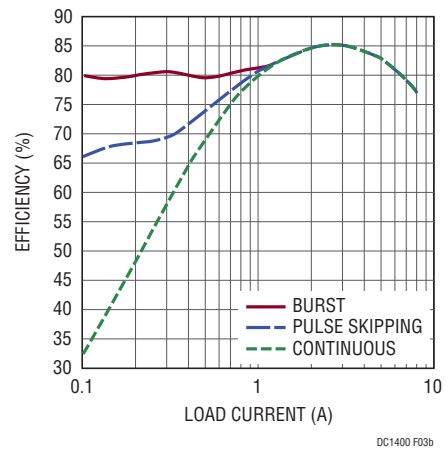

Efficiency vs Load Current with 3.3V_{IN}, 1.2V_{OUT}

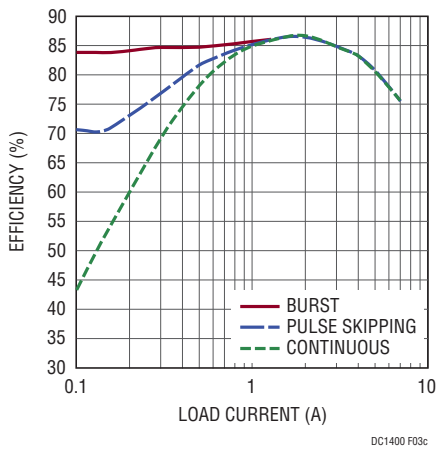

Efficiency vs Load Current with 3.3V_{IN}, 1.5V_{OUT}

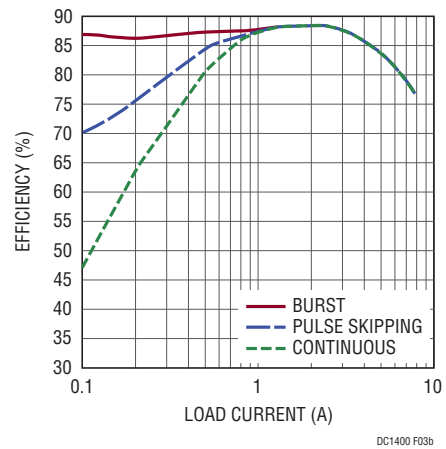

Figure 3. Measured Supply Efficiency with Different V_{IN} and V_{OUT}

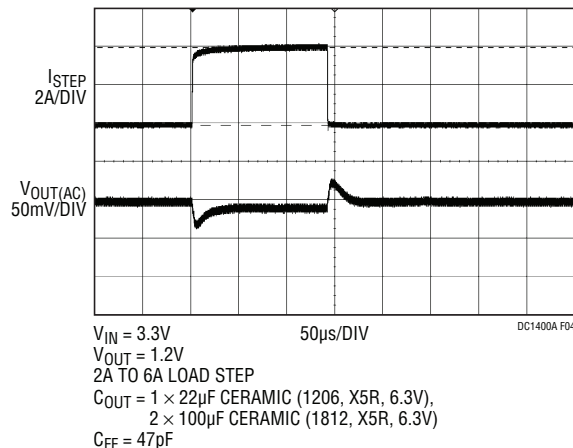

Figure 4. Measured Load Transient Response (4A Step, 25% to 75%)

DEMO MANUAL DC1400A

PARTS LIST

ITEM	QTY	REFERENCE	DESCRIPTION	MANUFACTURER'S PART NUMBER
Required Circuit Components				
1	1	CFF	CAP, 0603 47pF 10% 25V NPO	AVX 06033A470KAT
2	1	CIN1	CAP, 150μF 20% 10V ELEC	SANYO 10SVPA150MAA
3	2	CIN5, CIN4	CAP, 0805 10μF 10% 6.3V X5R	AVX 08056D106KAT2A
4	1	C03	CAP, 1206 22μF 20% 6.3V X5R	AVX 12066D226MAT2A
5	2	C05, C04	CAP, 1812 100μF 20% 6.3V X5R	TDK C4532X5R0J107MZ
6	1	R14	RES, 0603 9.76k 1% 1/10W	VISHAY CRCW06039K76FKEA
7	1	U1	IC, LOW VOLTAGE POWER MODULE	LINEAR TECH. LTM4608AEV
Additional Demo Board Circuit Components				
1	0	C02, CIN3	CAP, 1812 100μF 20% 6.3V X5R OPTION	TDK C4532X5R0J107MZ OPTION
2	0	C01	CAP, 1812 OPTION	TAIYO YUDEN JMK432BJ107MU-T OPTION
3	0	C14, C21, CTHP, CP	CAP, 0603 OPTION	OPTION
4	1	C15	CAP, 0603 1μF 20% 10V X5R	TAIYO YUDEN LMK107BJ105MA-T
5	0	C17	CAP, 0603 1μF 20% 16V X5R OPTION	TDK C1608X7R1C105M OPTION
6	1	Q14	XSTR, MOSFET	VISHAY SUD50N03-09CP-E3
7	1	R1	RES, 0603 4.99k 1% 1/10W	VISHAY CRCW06034K99FKEA
8	1	R2	RES, 0603 6.65k 1% 1/10W	VISHAY CRCW06036K65FKEA
9	1	R3	RES, 0603 3.16k 1% 1/10W	VISHAY CRCW06033K16FKEA
10	1	R4	RES, 0603 2.21k 1% 1/10W	VISHAY CRCW06032K21FKEA
11	0	R8, R5	RES, 0603 OPTION	OPTION
12	3	R6, R9, R16	RES, 0603 0Ω JUMPER	VISHAY CRCW06030000Z0EA
13	2	R10, R15	RES, 0603 10k 5% 1/10W	VISHAY CRCW060310K0JNEA
14	1	R11	RES, 2512 0.01Ω 1% 1W	PANASONIC ERJ-M1WSF10MU
15	2	R18, R17	RES, 0603 51Ω 5% 1/10W	VISHAY CRCW060351R0JNEA
Hardware				
1	5	JP1, JP2, JP3, JP4, JP5	HEADER, 2-PIN, 2mm	SAMTEC TMM 102-02-L-S
2	3	JP7, JP8, JP13	HEADER, 3-PIN, 2mm	SAMTEC TMM-103-02-L-S
3	4	JP9, JP10, JP11, JP12	HEADER, 3 × 2 2mm	SAMTEC TMM-103-02-L-D
4	4	J1, J2, J3, J4	JACK, BANANA	KEYSTONE 575-4
5	2	J5, J6	CONN, BNC, 5 PINS	CONNEX 112404
6	10	TP1-TP9, TP11	TURRET	MILL MAX 2501-2-00-80-00-00-07-0
7	8	JP1, JP7-JP13	SHUNT, 2mm	SAMTEC 2SN-BK-G
8	4		STANDOFF, SNAP ON	KEYSTONE_8834

SCHEMATIC DIAGRAM

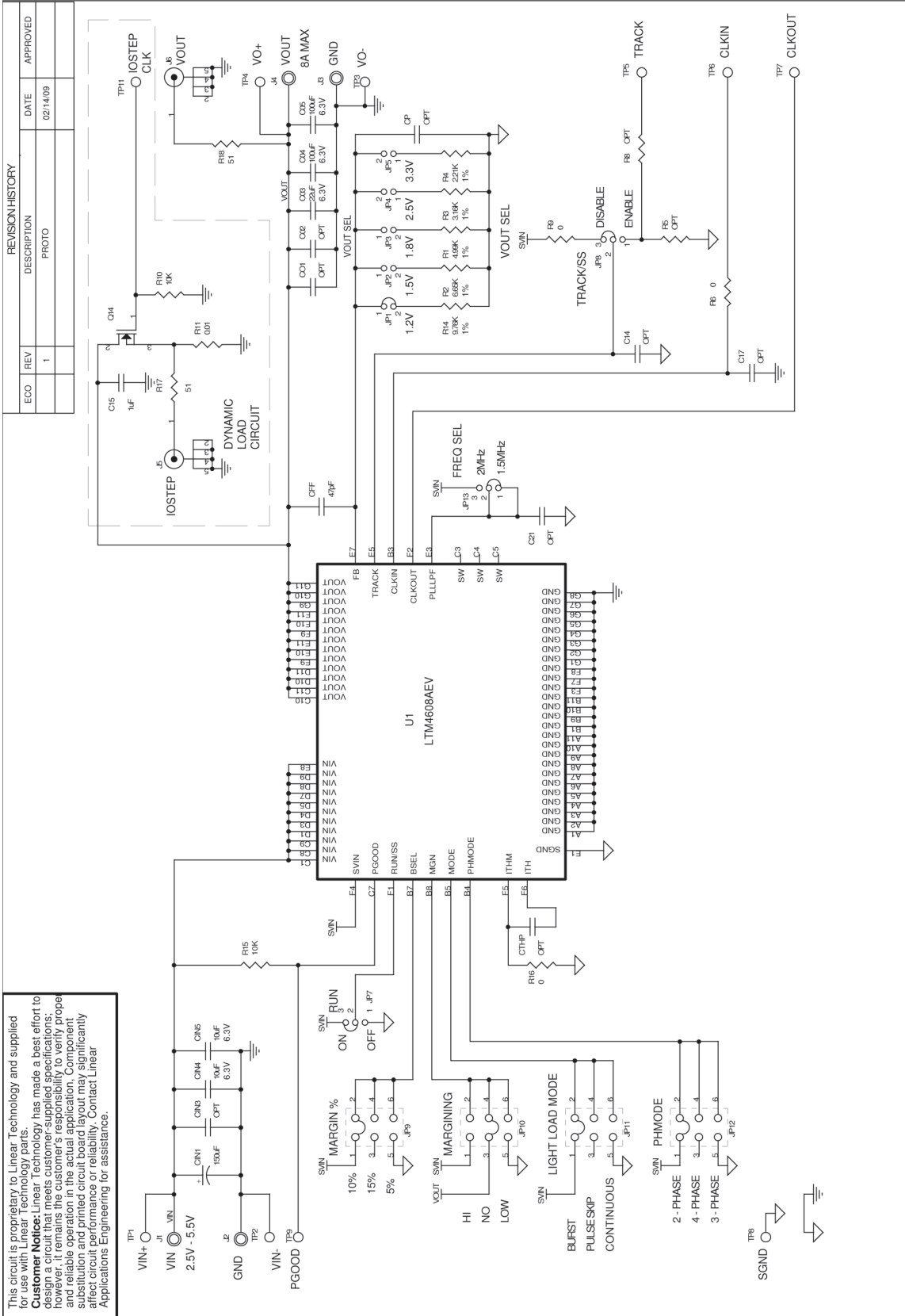

This circuit is proprietary to Linear Technology and supplied for use with Linear Technology parts.
Customer Notice: Linear Technology has made a best effort to ensure that the information in this document is accurate and reliable, however, it remains the customer's responsibility to verify proper and reliable operation in the actual application. Component substitution and printed circuit board layout may significantly affect circuit performance or reliability. Contact Linear Applications Engineering for assistance.

DEMO MANUAL DC1400A

DEMONSTRATION BOARD IMPORTANT NOTICE

Linear Technology Corporation (LTC) provides the enclosed product(s) under the following **AS IS** conditions:

This demonstration board (DEMO BOARD) kit being sold or provided by Linear Technology is intended for use for **ENGINEERING DEVELOPMENT OR EVALUATION PURPOSES ONLY** and is not provided by LTC for commercial use. As such, the DEMO BOARD herein may not be complete in terms of required design-, marketing-, and/or manufacturing-related protective considerations, including but not limited to product safety measures typically found in finished commercial goods. As a prototype, this product does not fall within the scope of the European Union directive on electromagnetic compatibility and therefore may or may not meet the technical requirements of the directive, or other regulations.

If this evaluation kit does not meet the specifications recited in the DEMO BOARD manual the kit may be returned within 30 days from the date of delivery for a full refund. **THE FOREGOING WARRANTY IS THE EXCLUSIVE WARRANTY MADE BY THE SELLER TO BUYER AND IS IN LIEU OF ALL OTHER WARRANTIES, EXPRESSED, IMPLIED, OR STATUTORY, INCLUDING ANY WARRANTY OF MERCHANTABILITY OR FITNESS FOR ANY PARTICULAR PURPOSE. EXCEPT TO THE EXTENT OF THIS INDEMNITY, NEITHER PARTY SHALL BE LIABLE TO THE OTHER FOR ANY INDIRECT, SPECIAL, INCIDENTAL, OR CONSEQUENTIAL DAMAGES.**

The user assumes all responsibility and liability for proper and safe handling of the goods. Further, the user releases LTC from all claims arising from the handling or use of the goods. Due to the open construction of the product, it is the user's responsibility to take any and all appropriate precautions with regard to electrostatic discharge. Also be aware that the products herein may not be regulatory compliant or agency certified (FCC, UL, CE, etc.).

No License is granted under any patent right or other intellectual property whatsoever. **LTC assumes no liability for applications assistance, customer product design, software performance, or infringement of patents or any other intellectual property rights of any kind.**

LTC currently services a variety of customers for products around the world, and therefore this transaction **is not exclusive**.

Please read the DEMO BOARD manual prior to handling the product. Persons handling this product must have electronics training and observe good laboratory practice standards. **Common sense is encouraged.**

This notice contains important safety information about temperatures and voltages. For further safety concerns, please contact a LTC application engineer.

Mailing Address:

Linear Technology
1630 McCarthy Blvd.
Milpitas, CA 95035

Copyright © 2004, Linear Technology Corporation

Компания «Океан Электроники» предлагает заключение долгосрочных отношений при поставках импортных электронных компонентов на взаимовыгодных условиях!

Наши преимущества:

- Поставка оригинальных импортных электронных компонентов напрямую с производств Америки, Европы и Азии, а так же с крупнейших складов мира;
- Широкая линейка поставок активных и пассивных импортных электронных компонентов (более 30 млн. наименований);
- Поставка сложных, дефицитных, либо снятых с производства позиций;
- Оперативные сроки поставки под заказ (от 5 рабочих дней);
- Экспресс доставка в любую точку России;
- Помощь Конструкторского Отдела и консультации квалифицированных инженеров;
- Техническая поддержка проекта, помощь в подборе аналогов, поставка прототипов;
- Поставка электронных компонентов под контролем ВП;
- Система менеджмента качества сертифицирована по Международному стандарту ISO 9001;
- При необходимости вся продукция военного и аэрокосмического назначения проходит испытания и сертификацию в лаборатории (по согласованию с заказчиком);
- Поставка специализированных компонентов военного и аэрокосмического уровня качества (Xilinx, Altera, Analog Devices, Intersil, Interpoint, Microsemi, Actel, Aeroflex, Peregrine, VPT, Syfer, Eurofarad, Texas Instruments, MS Kennedy, Miteq, Cobham, E2V, MA-COM, Hittite, Mini-Circuits, General Dynamics и др.);

Компания «Океан Электроники» является официальным дистрибьютором и эксклюзивным представителем в России одного из крупнейших производителей разъемов военного и аэрокосмического назначения «**JONHON**», а так же официальным дистрибьютором и эксклюзивным представителем в России производителя высокотехнологичных и надежных решений для передачи СВЧ сигналов «**FORSTAR**».



JONHON

«**JONHON**» (основан в 1970 г.)

Разъемы специального, военного и аэрокосмического назначения:

(Применяются в военной, авиационной, аэрокосмической, морской, железнодорожной, горно- и нефтедобывающей отраслях промышленности)

«**FORSTAR**» (основан в 1998 г.)

ВЧ соединители, коаксиальные кабели,
кабельные сборки и микроволновые компоненты:

(Применяются в телекоммуникациях гражданского и специального назначения, в средствах связи, РЛС, а так же военной, авиационной и аэрокосмической отраслях промышленности).



Телефон: 8 (812) 309-75-97 (многоканальный)

Факс: 8 (812) 320-03-32

Электронная почта: ocean@oceanchips.ru

Web: <http://oceanchips.ru/>

Адрес: 198099, г. Санкт-Петербург, ул. Калинина, д. 2, корп. 4, лит. А