

## RA Varistor Series



### Agency Approvals

Agency	Agency Approval	Agency File Number
	UL1449	E320116

### Additional Information



Datasheet



Resources



Samples

### Description

The RA Series transient surge suppressors are varistors (MOVs) supplied in a low-profile box that features a precise seating plane to increase mechanical stability for secure circuit-board mounting. This feature makes these devices suitable for industrial applications critical to vibration. Their construction permits operation up to 125°C (ambient) without derating.

The RA Series are available in voltage ratings up to 275V  $V_{M(AC)RMS}$  and energy levels up to 140J. These varistors are used in automotive, motor-control, telecommunication, and military applications.

See RA Series Device Ratings and Specifications Table for part number and brand information.

### Features

- Lead-free/RoHS compliant parts available (add suffix "x2749")
- Low profile outline with precise seating plane
- No derating up to 125°C ambient
- In-line leads
- Wide operating voltage range:  
 $V_{M(AC)RMS}$ : 4 – 275V  
 $V_{M(DC)}$ : 5.5 – 369V
- High energy absorption capability  $W_{TM}$  up to 140J
- 3 model sizes available A8, RA16, and RA22

### Absolute Maximum Ratings

• For ratings of individual members of a series, see Device Ratings and Specifications chart

Continuous	RA8 Series	RA16 Series	RA22 Series	Units
Steady State Applied Voltage:				
AC Voltage Range ( $V_{M(AC)RMS}$ )	4 to 275	10 to 275	4 to 275	V
DC Voltage Range ( $V_{M(DC)}$ )	5.5 to 369	14 to 369	18 to 369	V
Transients:				
Peak Pulse Current ( $I_{TM}$ )				
For 8/20 $\mu$ s Current Wave (See Figure 2)	100 to 1200	1000 to 4500	2000 to 6500	A
Single Pulse Energy Range (Note 1)				
For 10/1000 $\mu$ s Current Wave ( $W_{TM}$ )	0.4 to 23	3.5 to 75	70 to 160	J
Operating Ambient Temperature Range ( $T_A$ )	-55 to +125	-55 to +125	-55 to +125	°C
Storage Temperature Range ( $T_{STG}$ )	-55 to +150	-55 to +150	-55 to +150	°C
Temperature Coefficient ( $\alpha$ ) of Clamping Voltage ( $V_C$ ) at Specified Test Current	<0.01	<0.01	<0.01	%/°C
Hi-Pot Encapsulation (COATING Isolation Voltage Capability) (Dielectric must withstand indicated DC voltage for one minute per MIL-STD 202, Method 301)	5000	5000	5000	V
COATING Insulation Resistance	1000	1000	1000	M $\Omega$

*CAUTION: Stresses above those listed in "Absolute Maximum Ratings" may cause permanent damage to the device. This is a stress only rating and operation of the device at these or any other conditions above those indicated in the operational sections of this specification is not implied.*

### RA Series Ratings & Specifications

Part Number	Brand	Maximum Rating (125°C)				Specifications (25°C)					
		Continuous		Transient		Varistor Voltage at 1mA DC Test Current			Max Clamping Volt $V_C$ (8/20 $\mu$ s)		Typical Capacitance
		$V_{RMS}$	$V_{DC}$	Energy (10/1000 $\mu$ s)	Peak Current (8/20 $\mu$ s)						
		$V_{M(AC)}$	$V_{M(DC)}$	$W_{TM}$	$I_{TM}$	Min	$V_{N(DC)}$	Max	$V_C$	$I_P$	f = 1MHz
(mm)	(V)	(V)	(J)	(A)	(V)	(V)	(V)	(V)	(A)	(pF)	
<b>† RA8 Series</b>											
V8RA8	8R	4	5.5	0.4	150	6	8.6	11.2	22	5	3000
V12RA8	12R	6	8	0.6	150	9	12.5	16	34	5	2500
V18RA8	18R	10	14	0.8	250	16.2	18	19.8	42	5	2000
V22RA8	22R	14	18 (Note 3)	10 (Note 2)	250	19.8	22	24.2	47	5	1600
V27RA8	27R	17	22	1.0	250	24.3	27	29.7	57	5	1300
V33RA8	33R	20	26	1.2	250	29.7	33	36.3	68	5	1100
V39RA8	39R	25	31	1.5	250	35.1	39	42.9	79	5	900
V47RA8	47R	30	38	1.8	250	42.3	47	51.7	92	5	800
V56RA8	56R	35	45	2.3	250	50.4	56	61.6	107	5	700
V68RA8	68R	40	56	3.0	250	61.2	68	74.8	127	5	600
V82RA8	82R	50	66	4.0	1200	73.8	82	90.2	135	10	500
V100RA8	100R	60	81	5.0	1200	90	100	110	165	10	400
V120RA8	120R	75	102	6.0	1200	108	120	132	205	10	300
V150RA8	150R	95	127	8.0	1200	135	150	165	250	10	250
V180RA8	180R	115	153	10.0	1200	162	180	198	295	10	200
V200RA8	200R	130	175	11.0	1200	184.5	205	225.5	340	10	180
† V220RA8	220R	140	180	12.0	1200	198	220	242	360	10	160
† V240RA8	240R	150	200	13.0	1200	216	240	264	395	10	150
† V270RA8	270R	175	225	15.0	1200	243	270	297	455	10	130
† V360RA8	360R	230	300	20.0	1200	324	360	396	595	10	100
† V390RA8	390R	250	330	21.0	1200	351	390	429	650	10	90
† V430RA8	430R	275	369	23.0	1200	387	430	473	710	10	80
<b>† RA16 Series</b>											
V18RA16	18R16	10	14	3.5	1000	16.2	18	19.8	39	10	11000
V22RA16	22R16	14	18 (Note 3)	50 (Note 2)	1000	19.8	22	24.2	43	10	9000
V27RA16	27R16	17	22	5.0	1000	24.3	27	29.7	53	10	7000
V33RA16	33R16	20	26	6.0	1000	29.7	33	36.3	64	10	6000
V39RA16	39R16	25	31	7.2	1000	35.1	39	42.9	76	10	5000
V47RA16	47R16	30	38	8.8	1000	42.3	47	51.7	89	10	4500
V56RA16	56R16	35	45	10.0	1000	50.4	56	61.6	103	10	3900
V68RA16	68R16	40	56	13.0	1000	61.2	68	74.8	123	10	3300
V82RA16	82R16	50	66	15.0	4500	73.8	82	90.2	145	50	2500
V100RA16	100R16	60	81	20.0	4500	90	100	110	175	50	2000
V120RA16	120R16	75	102	22.0	4500	108	120	132	205	50	1700
V150RA16	150R16	95	127	30.0	4500	135	150	165	255	50	1400
V180RA16	180R16	115	153	35.0	4500	162	180	198	300	50	1100
V200RA16	200R16	130	175	38.0	4500	184.5	205	225.5	340	50	1000
† V220RA16	220R16	140	180	42.0	4500	198	220	242	360	50	900
† V240RA16	240R16	150	200	45.0	4500	216	240	264	395	50	800
† V270RA16	270R16	175	225	55.0	4500	243	270	297	455	50	700
† V360RA16	360R16	230	300	70.0	4500	324	360	396	595	50	550
† V390RA16	390R16	250	330	72.0	4500	351	390	429	650	50	500
† V430RA16	430R16	275	369	75.0	4500	387	430	473	710	50	450

### RA Series Ratings & Specifications

Part Number	Brand	Maximum Rating (125°C)				Specifications (25°C)					
		Continuous		Transient		Varistor Voltage at 1mA DC Test Current			Max Clamping Volt $V_C$ (8/20 $\mu$ s)		Typical Capacitance
		$V_{RMS}$	$V_{DC}$	Energy (10/1000 $\mu$ s)	Peak Current (8/20 $\mu$ s)						
		$V_{M(AC)}$	$V_{M(DC)}$	$W_{TM}$	$I_{TM}$	Min	$V_{N(DC)}$	Max	$V_C$	$I_P$	f = 1MHz
(mm)	(V)	(V)	(J)	(A)	(V)	(V)	(V)	(V)	(A)	(pF)	
<b>† RA22 Series</b>											
V24RA22	24R22	14	18 (Note 3)	100.0 (Note 2)	2000	21.6	24	26.4	43	20	18000
V36RA22	36R22	23	31	160.0 (Note 2)	2000	32.4	36	39.6	63	20	12000
† V200RA22	200R22	130	175	70.0	6500	184.5	205	225.5	340	100	1900
† V240RA22	240R22	150	200	80.0	6500	216	240	264	395	100	1600
† V270RA22	270R22	175	225	90.0	6500	243	270	297	455	100	1400
† V390RA22	390R22	250	330	130.0	6500	351	390	429	650	100	1000
† V430RA22	430R22	275	369	140.0	6500	387	430	473	710	100	900

- NOTES:
1. Average power dissipation of transients not to exceed 0.25W for RA8 Series, 0.60W for RA16 Series, or 1.0W for RA22 Series.
  2. Energy ratings for impulse duration of 30ms minimum to one half of peak current value.
  3. Also rated to withstand 24V for 5 minutes.
  4. 10mA DC Test Current.
- † Under UL File No. E320116 as a recognized component. CSA approved File No. 91788.

### Power Dissipation Ratings



Should transients occur in rapid succession, the average power dissipation required is simply the energy (watt-seconds) per pulse times the number of pulses per second. The power so developed must be within the specifications shown on the Device Ratings and Specifications table for the specific device. Furthermore, the operating values need to be derated at high temperatures as shown above. Because varistors can only dissipate a relatively small amount of average power they are, therefore, not suitable for repetitive applications that involve substantial amounts of average power dissipation.

### Peak Pulse Current Test Waveform



- $0_1$  = Virtual Origin of Wave
- $T$  = Time from 10% to 90% of Peak
- $T_1$  = Rise Time =  $1.25 \times T$
- $T_2$  = Decay Time

**Example** - For an 8/20  $\mu$ s Current Waveform:

- $8\mu\text{s} = T_1$  = Rise Time
- $20\mu\text{s} = T_2$  = Decay Time

**Maximum Clamping Voltage for 8mm Parts**

V8RA8 - V68RA8

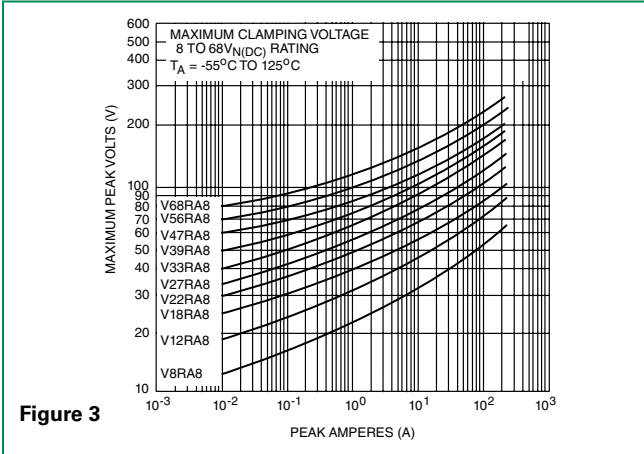

Figure 3

**Repetitive Surge Capability for 8mm Parts**

V8RA8 - V12RA8



Figure 5

V82RA8 - V430RA8



Figure 4

V18RA8 - V68RA8



Figure 6

V82RA8 - V430RA8

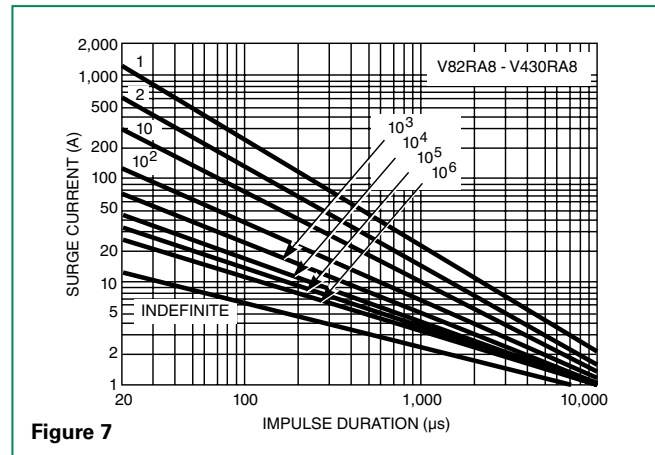

Figure 7

**Maximum Clamping Voltage for 16mm Parts**

V18RA16 - V68RA16

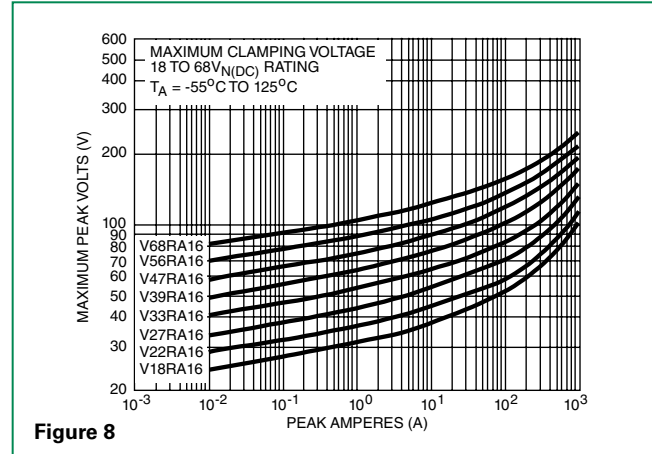

Figure 8

**Repetitive Surge Capability for 16mm Parts**

V18RA16 - V68RA16

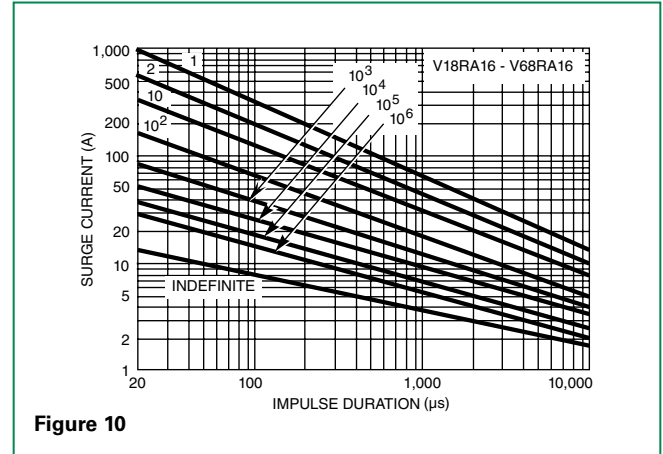

Figure 10

V82RA16 - V430RA16

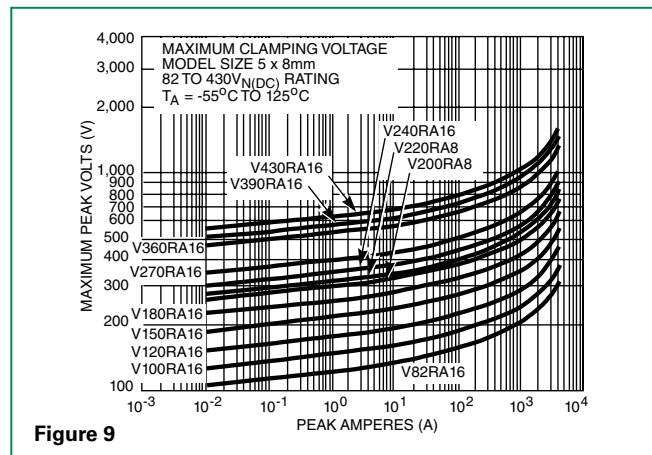

Figure 9

V82RA16 - V430RA16

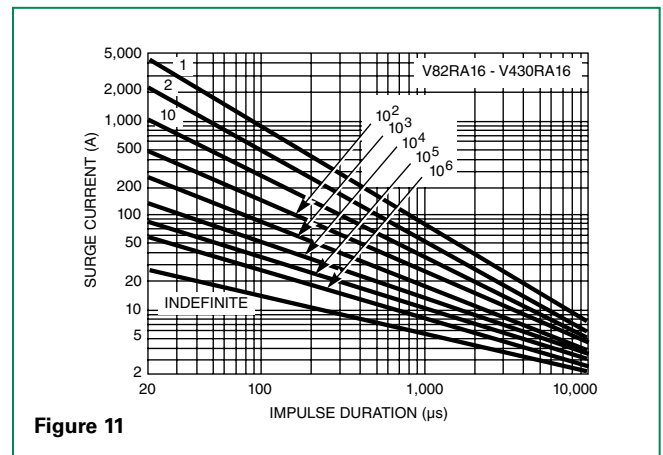

Figure 11

**Maximum Clamping Voltage for 22mm Parts**

V24RA22 - V36RA22



Figure 12

**Repetitive Surge Capability for 22mm Parts**

V24RA22 - V36RA22

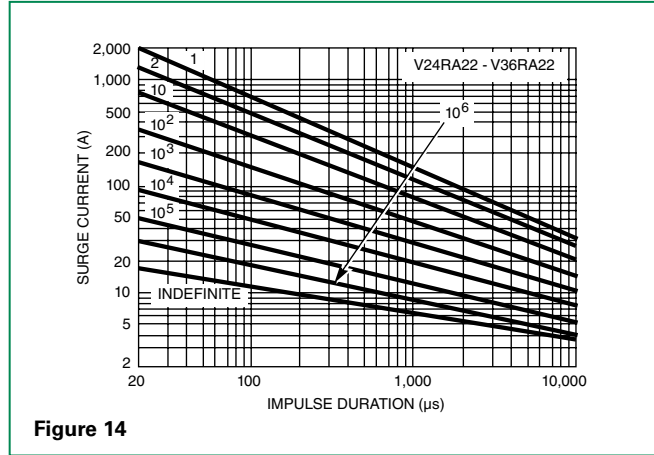

Figure 14

V200RA22 - V430RA22



Figure 13

V200RA22 - V430RA22

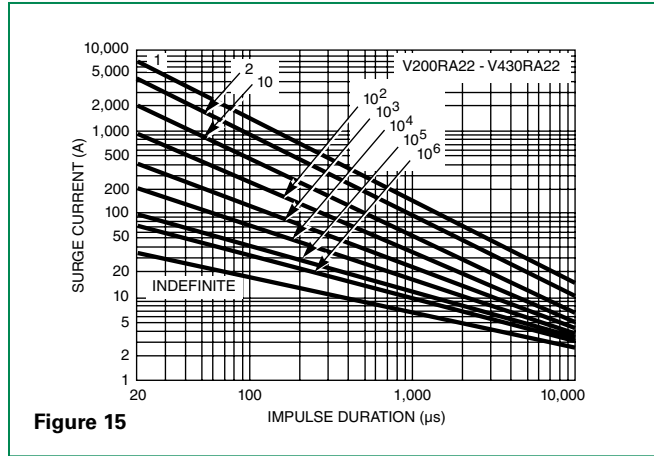

Figure 15

NOTE: If pulse ratings are exceeded, a shift of  $V_{N(DC)}$  (at specified current) of more than  $\pm 10\%$  could result. This type of shift, which normally results in a decrease of  $V_{N(DC)}$ , may result in the device not meeting the original published specifications, but it does not prevent the device from continuing to function, and to provide ample protection.

### Wave Solder Profile

Reflow Condition		Pb – Free assembly
Pre Heat	- Temperature Min (Ts(min))	150°C
	- Temperature Max (Ts(max))	200°C
	- Time (min to max) (ts)	60 – 180 secs
Average ramp-up rate (Liquidus Temp (TL) to peak)		5°C/second max
TS(max) to TL - Ramp-up Rate		5°C/second max
Reflow	- Temperature (TL) (Liquidus)	217°C
	- Temperature (tL)	60 – 150 seconds
Peak Temperature (TP)		250+0/-5°C
Time within 5°C of actual peak Temperature (tp)		20 – 40 seconds
Ramp-down Rate		5°C/second max
Time 25°C to peak Temperature (TP)		8 minutes Max.
Do not exceed		260°C

### Lead-free Profile



### Non Lead-free Profile

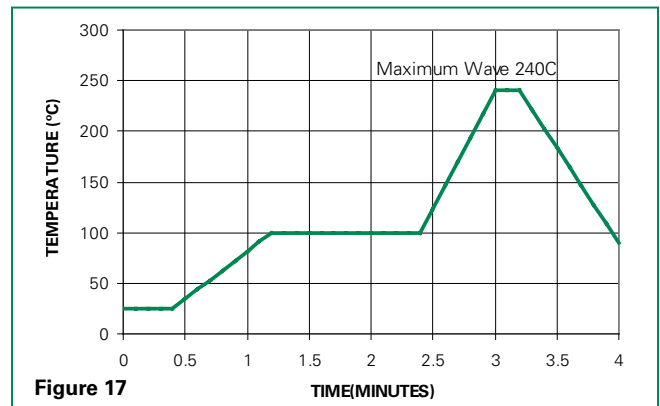

### Environmental Specifications

<b>Operating/Storage Temperature</b>	-55°C to +125°C / -55°C to +150°C
<b>Humidity Aging</b>	+85°C, 85% RH, 1000 hours +/-10% Voltage
<b>Thermal Shock</b>	+85°C to -40°C 10 times +/-10% Voltage
<b>Solvent Resistance</b>	MIL-STD-202, Method 215
<b>Moisture Sensitivity</b>	Level 1, J-STD-020

### Physical Specifications

<b>Lead Material</b>	Tin-Coated
<b>Soldering Characteristics</b>	Solderability per MIL-STD-202, Method 208
<b>Insulating Material</b>	Cured, flame retardant epoxy polymer meets UL94V-0 requirements.
<b>Device Labeling</b>	Marked with LF, voltage, amperage rating, and date code.

**Product Dimensions (mm)**

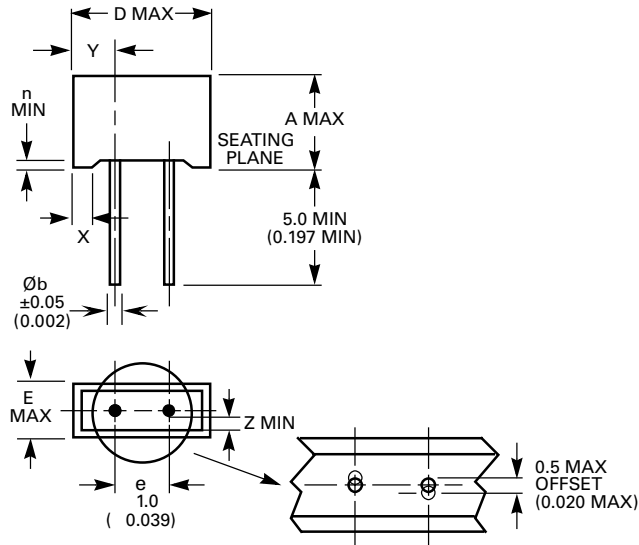

SYMBOL	RA8 Series	RA16 Series	RA22 Series
<b>A</b> (max.)	8.85 (0.348)	15.1 (0.594)	19.1 (0.752)
<b>D</b> (max.)	11.45 (0.450)	19.7 (0.776)	25.5 (1.004)
<b>e ± 1</b>	5 (0.197)	7.5 (0.295)	7.5 (0.295)
<b>E</b> (max.)	5.2 (0.205)	6.3 (0.248)	6.3 (0.248)
<b>n</b> (max.)	0.7 (0.027)	0.7 (0.027)	0.7 (0.027)
<b>Øb ± 0.05</b>	0.635 (0.025)	0.81 (0.032)	0.81 (0.032)
<b>Weight</b> (typical)	1 Gram	3.4 Grams	4.4 Grams
<b>X</b>	2.2 (0.087)	2.2 (0.087)	4.4 (0.173)
<b>Y (Typ.)</b>	3.1 -/+ 0.5 (0.122 -/+ 0.02)	6 -/+ 1 (0.236 -/+ 0.04)	8.9 -/+ 1 (0.35 -/+ 0.04)
<b>Z</b> (min.)	0.4 (0.015)	0.8 (0.031)	0.8 (0.031)

NOTES: Dimensions are in mm, with dimensions in inches in parentheses. Inches for reference only.

**Part Numbering System**

The RA Series is supplied in bulk pack.

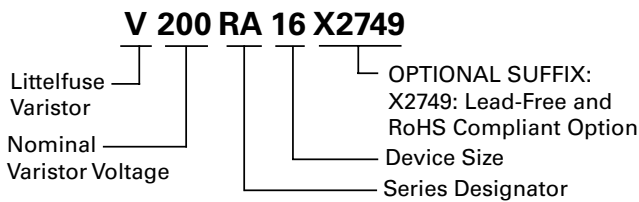



Компания «Океан Электроники» предлагает заключение долгосрочных отношений при поставках импортных электронных компонентов на взаимовыгодных условиях!

Наши преимущества:

- Поставка оригинальных импортных электронных компонентов напрямую с производств Америки, Европы и Азии, а так же с крупнейших складов мира;
- Широкая линейка поставок активных и пассивных импортных электронных компонентов (более 30 млн. наименований);
- Поставка сложных, дефицитных, либо снятых с производства позиций;
- Оперативные сроки поставки под заказ (от 5 рабочих дней);
- Экспресс доставка в любую точку России;
- Помощь Конструкторского Отдела и консультации квалифицированных инженеров;
- Техническая поддержка проекта, помощь в подборе аналогов, поставка прототипов;
- Поставка электронных компонентов под контролем ВП;
- Система менеджмента качества сертифицирована по Международному стандарту ISO 9001;
- При необходимости вся продукция военного и аэрокосмического назначения проходит испытания и сертификацию в лаборатории (по согласованию с заказчиком);
- Поставка специализированных компонентов военного и аэрокосмического уровня качества (Xilinx, Altera, Analog Devices, Intersil, Interpoint, Microsemi, Actel, Aeroflex, Peregrine, VPT, Syfer, Eurofarad, Texas Instruments, MS Kennedy, Miteq, Cobham, E2V, MA-COM, Hittite, Mini-Circuits, General Dynamics и др.);

Компания «Океан Электроники» является официальным дистрибьютором и эксклюзивным представителем в России одного из крупнейших производителей разъемов военного и аэрокосмического назначения «JONHON», а так же официальным дистрибьютором и эксклюзивным представителем в России производителя высокотехнологичных и надежных решений для передачи СВЧ сигналов «FORSTAR».



## JONHON

«JONHON» (основан в 1970 г.)

Разъемы специального, военного и аэрокосмического назначения:

(Применяются в военной, авиационной, аэрокосмической, морской, железнодорожной, горно- и нефтедобывающей отраслях промышленности)

«FORSTAR» (основан в 1998 г.)

ВЧ соединители, коаксиальные кабели, кабельные сборки и микроволновые компоненты:

(Применяются в телекоммуникациях гражданского и специального назначения, в средствах связи, РЛС, а так же военной, авиационной и аэрокосмической отраслях промышленности).



Телефон: 8 (812) 309-75-97 (многоканальный)

Факс: 8 (812) 320-03-32

Электронная почта: [ocean@oceanchips.ru](mailto:ocean@oceanchips.ru)

Web: <http://oceanchips.ru/>

Адрес: 198099, г. Санкт-Петербург, ул. Калинина, д. 2, корп. 4, лит. А