

## Description

The AP3783 is a high performance AC/DC power supply controller for battery charger and adapter applications. The controller regulates the output voltage and current in the primary side by piece-wise Pulse Frequency Modulation (p-PFM) in discontinuous conduction mode (DCM).

The AP3783 provides accurate constant voltage (CV), constant current (CC) and outstanding dynamic performance without requiring an opto-coupler. It also eliminates the need of loop compensation circuitry while maintaining stability.

The AP3783 provides valley turn-on function, operating frequency Jitter function (about 5.5% frequency change every 256 $\mu$ s) from light to full load range and 3-segment drive current to improve the power supply EMI performance. The AP3783 also has built-in fixed cable voltage drop compensation (4%, 7% and 12% of nominal system output voltage to meet various cables with different length and gauge) and adjustable line voltage compensation.

The AP3783 is packaged in SOT26.

## Applications

- Adapters/Chargers
- LED Lighting
- Standby and Auxiliary Power Supplies

## Pin Assignments

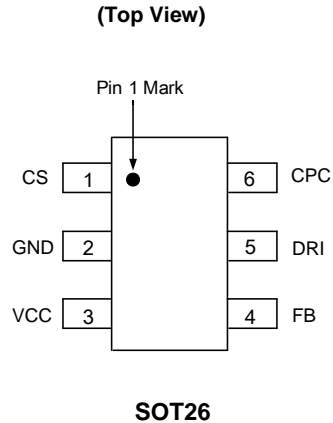

## Features

- Less than 75mW Standby Power Consumption
- Meet Efficiency Requirement of COC Trier2
- Valley Turn-on to Reduce Switching Loss and Improve EMI
- Piece-wise Frequency Reduction to Enhance Conversion Efficiency and Suppress Audio Noise
- Over Voltage Protection (OVP)
- Over Temperature Protection (OTP)
- Short Circuit Protection (SCP) with Hiccup
- 3-Segment Drive Current for Radiative EMI Suppression
- Operating Frequency Jitter Function for Conductive EMI Suppression
- Drive MOSFET for 5W to 30W Battery Charger/Adapter Applications
- SOT26 SMD Package Comply with Level 3 of IPC/JEDEC J-STD-033A
- **Totally Lead-Free & Fully RoHS Compliant (Notes 1 & 2)**
- **Halogen and Antimony Free. "Green" Device (Note 3)**

- Notes:
1. No purposely added lead. Fully EU Directive 2002/95/EC (RoHS) & 2011/65/EU (RoHS 2) compliant.
  2. See [http://www.diodes.com/quality/lead\\_free.html](http://www.diodes.com/quality/lead_free.html) for more information about Diodes Incorporated's definitions of Halogen- and Antimony-free, "Green" and Lead-free.
  3. Halogen- and Antimony-free "Green" products are defined as those which contain <900ppm bromine, <900ppm chlorine (<1500ppm total Br + Cl) and <1000ppm antimony compounds.



**Functional Block Diagram**

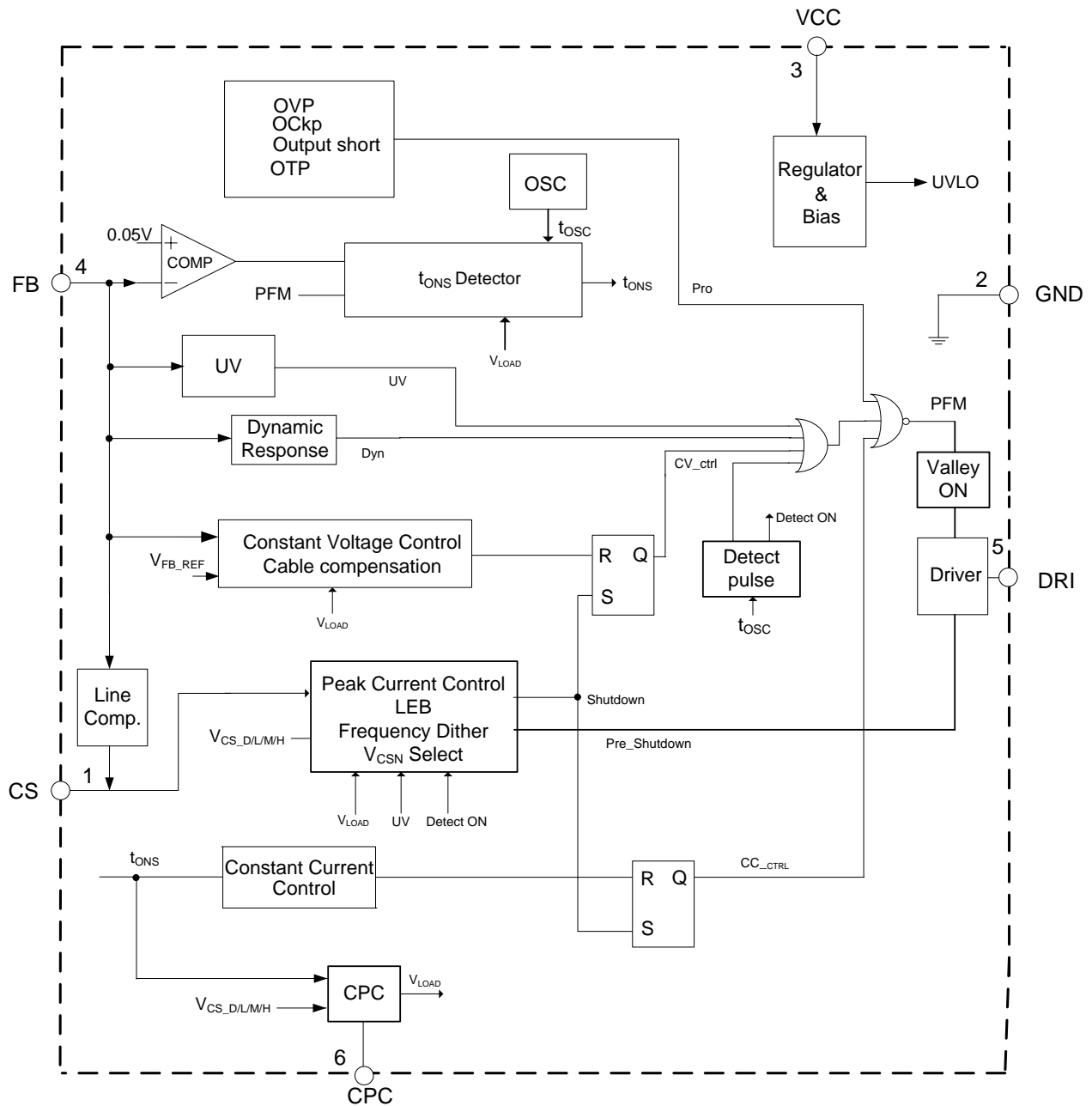

## Absolute Maximum Ratings (Note 4)

| Symbol                             | Parameter                                | Rating             | Unit |
|------------------------------------|--|--------------------|------|
| V <sub>CC</sub>                    | Supply Voltage                           | -0.3 to 35         | V    |
| V <sub>CS</sub> , V <sub>CPC</sub> | Voltage on CS, CPC Pin                   | -0.3 to 7          | V    |
| V <sub>FB</sub>                    | FB Input Voltage                         | -0.4 to 10         | V    |
| I <sub>SOURCE</sub>                | Source Current from OUT Pin              | Internally Limited | A    |
| T <sub>J</sub>                     | Operating Junction Temperature           | -40 to +150        | °C   |
| T <sub>STG</sub>                   | Storage Temperature                      | -65 to +150        | °C   |
| T <sub>LEAD</sub>                  | Lead Temperature (Soldering, 10 sec)     | +300               | °C   |
| θ <sub>JA</sub>                    | Thermal Resistance (Junction to Ambient) | 200                | °C/W |
| ESD                                | ESD (Human Body Model)                   | 6000               | V    |
|                                    | ESD (Charged Device Model)               | 400                | V    |

Note 4: Stresses greater than those listed under "Absolute Maximum Ratings" may cause permanent damage to the device. These are stress ratings only, and functional operation of the device at these or any other conditions beyond those indicated under "Recommended Operating Conditions" is not implied. Exposure to "Absolute Maximum Ratings" for extended periods may affect device reliability.

## Electrical Characteristics (@V<sub>CC</sub> = 15V, T<sub>A</sub> = +25°C, unless otherwise specified.)

| Symbol                          | Parameters                                       | Conditions   | Min  | Typ  | Max  | Unit |
|---------------------------------|--|--|------|------|------|------|
| <b>STARTUP AND UVLO SECTION</b> |  |  |      |      |      |      |
| V <sub>TH_ST</sub>              | Startup Threshold                                | –  | 13   | 15.5 | 18   | V    |
| V <sub>OPR(MIN)</sub>           | Minimal Operating Voltage                        | –  | 6    | 6.8  | 7.6  | V    |
| <b>STANDBY CURRENT SECTION</b>  |  |  |      |      |      |      |
| I <sub>ST</sub>                 | Startup Current                                  | V <sub>CC</sub> = V <sub>TH_ST</sub> - 1V before startup | 0    | 0.2  | 0.6  | µA   |
| I <sub>CC_OPR</sub>             | Operating Current                                | Static current @ no load                                 | 300  | 450  | 600  |      |
| <b>DRIVING OUTPUT SECTION</b>   |  |  |      |      |      |      |
| V <sub>GATE</sub>               | Gate Voltage                                     | –  | 12   | 13   | 14   | V    |
| I <sub>SOURCE_L</sub>           | Low Driver Source Current                        | –  | 17.5 | 20   | 22.5 | mA   |
| I <sub>SOURCE_H</sub>           | High Driver Source Current                       | –  | 100  | 110  | 120  | mA   |
| V <sub>TH</sub>                 | High/Low Driver Source Current Threshold Voltage | –  | 6    | 6.5  | 7    | V    |
| R <sub>SINK</sub>               | Sink Resistance                                  | –  | 5.5  | 6.5  | 7.5  | Ω    |

**Electrical Characteristics** (Cont.) (@V<sub>CC</sub> = 15V, T<sub>A</sub> = +25°C, unless otherwise specified.)

| Symbol                                    | Parameters                                    | Conditions                                  | Min  | Typ  | Max  | Unit |
|---|---|---|------|------|------|------|
| <b>OPERATING FREQUENCY SECTION</b>        |   |   |      |      |      |      |
| f <sub>S(MAX)</sub>                       | The Maximum Operating Frequency               | I <sub>O(MAX)</sub> (Note 5)                | –    | –    | 60   | kHz  |
| t <sub>OFF(MAX)</sub>                     | Maximum Off Time                              |   | 691  | 768  | 845  | µs   |
| t <sub>SAMPLE_H</sub>                     | Sample Time                                   | 57% to 100% I <sub>O(MAX)</sub>             | 5.2  | 5.8  | 6.4  | µs   |
| t <sub>SAMPLE_M</sub>                     |   | 34% to 57% I <sub>O(MAX)</sub><br>(Note 6)  | 4.3  | 4.8  | 5.3  | µs   |
| t <sub>SAMPLE_L</sub>                     |   | 5.5% to 34% I <sub>O(MAX)</sub><br>(Note 6) | 2.7  | 3    | 3.3  | µs   |
| t <sub>SAMPLE_D</sub>                     |   | 0% to 5.5% I <sub>O(MAX)</sub><br>(Note 6)  | 1.5  | 1.7  | 1.9  | µs   |
| <b>FREQUENCY JITTER SECTION</b>           |   |   |      |      |      |      |
| ΔV <sub>CS</sub> /V <sub>CS</sub>         | V <sub>CS</sub> Modulation                    | 5.5% load to 100% I <sub>O(MAX)</sub>       | 4.5  | 5    | 5.5  | %    |
| f <sub>MOD</sub>                          | V <sub>CS</sub> Modulation Frequency          | 5.5% load to 100% I <sub>O(MAX)</sub>       | 3.6  | 4    | 4.4  | kHz  |
| <b>CURRENT SENSE SECTION</b>              |   |   |      |      |      |      |
| V <sub>CS_H</sub>                         | Peak Current Sense Threshold Voltage          | 57% to 100% I <sub>O(MAX)</sub>             | 828  | 900  | 972  | mV   |
| V <sub>CS_M</sub>                         | As Above                                      | 34% to 57% I <sub>O(MAX)</sub> (Note 6)     | 690  | 750  | 810  | mV   |
| V <sub>CS_L</sub>                         | As Above                                      | 5.5% to 34% I <sub>O(MAX)</sub><br>(Note 6) | 414  | 450  | 486  | mV   |
| V <sub>CS_D</sub>                         | As Above                                      | 0% to 5.5% I <sub>O(MAX)</sub><br>(Note 6)  | 230  | 250  | 270  | mV   |
| R <sub>LINE</sub>                         | Built-in Line Compensation Resistor           | (Note 7)                                    | 245  | 260  | 275  | Ω    |
| t <sub>LEB</sub>                          | Leading Edge Blanking                         | V <sub>CS</sub> (Note 6)                    | 495  | 550  | 605  | ns   |
| <b>CONSTANT VOLTAGE SECTION</b>           |   |   |      |      |      |      |
| V <sub>FB</sub>                           | Feedback Voltage                              | Closed loop test of V <sub>OUT</sub>        | 3.95 | 4.01 | 4.07 | V    |
| R <sub>FB</sub>                           | FB Pin Input Resistance                       | V <sub>FB</sub> =4V                         | 560  | 700  | 840  | kΩ   |
| V <sub>CABLE</sub><br>/V <sub>OUT</sub> % | Cable Compensation Ratio                      | AP3783A                                     | 6    | 7    | 8    | %    |
|   |   | AP3783B                                     | 3    | 4    | 5    | %    |
|   |   | AP3783C                                     | 10   | 12   | 14   | %    |
| <b>CONSTANT CURRENT SECTION</b>           |   |   |      |      |      |      |
| t <sub>ONS</sub> /t <sub>SW</sub>         | Secondary Winding Conduction Duty             | V <sub>FB</sub> = 3.5V                      | 0.47 | 0.5  | 0.53 | –    |
| <b>VALLEY-ON SECTION</b>                  |   |   |      |      |      |      |
| t <sub>VAL-ON</sub>                       | Valid Off Time of Valley-on                   | From the end of t <sub>ONS</sub>            | 14.4 | 16   | 17.6 | µs   |
| <b>DYNAMIC SECTION</b>                    |   |   |      |      |      |      |
| V <sub>UV_H</sub>                         | Under Voltage of FB Pin for V <sub>CS_H</sub> | –   | 3.61 | 3.68 | 3.75 | V    |
| <b>PROTECTION FUNCTION SECTION</b>        |   |   |      |      |      |      |
| V <sub>FB(OVP)</sub>                      | Over Voltage Protection at FB Pin             | –   | 7.1  | 7.5  | 7.9  | V    |
| V <sub>CC(OVP)</sub>                      | Over Voltage Protection at VCC Pin            | –   | 28   | 30   | 32   | V    |
| t <sub>ONP(MAX)</sub>                     | Maximum Turn-on Time                          | –   | 13.5 | 16   | 18.5 | µs   |
| V <sub>FB(SCP)</sub>                      | Short Circuit Protection                      | V <sub>FB</sub> @ Hiccup                    | 2.45 | 2.6  | 2.75 | V    |
| t <sub>SCP</sub>                          | Maximum Time under V <sub>FB(SCP)</sub>       | –   | 115  | 128  | 141  | ms   |
| T <sub>OTP</sub>                          | Shutdown Temperature                          | –   | +144 | +160 | +176 | °C   |
| T <sub>HYS</sub>                          | Temperature Hysteresis                        | –   | +36  | +40  | +44  | °C   |

- Notes: 5. The output constant-current design value, generally set to 110% to 120% of full load.  
6. Guaranteed by Design.  
7. Line compensation voltage on CS reference:  $\Delta V_{CS\_REF} = 0.438 \times \frac{R_{LINE}}{R_{FBI} + R_{LINE}} \times V_{AUX}$

**Performance Characteristics**

**Start-up Voltage vs. Ambient Temperature**

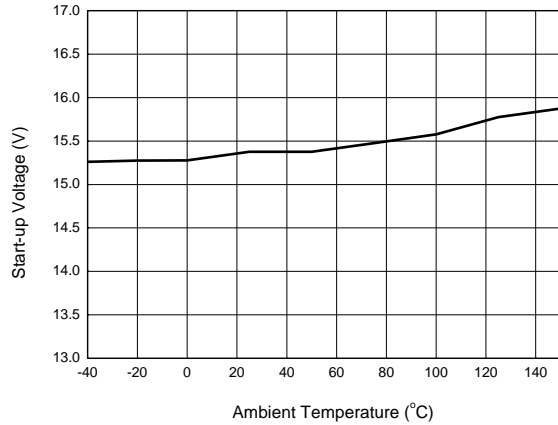

**Start-up Current vs. Ambient Temperature**

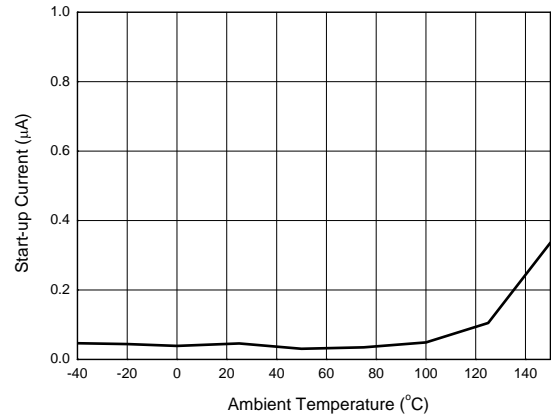

**Minimal Operating Voltage vs. Ambient Temperature**

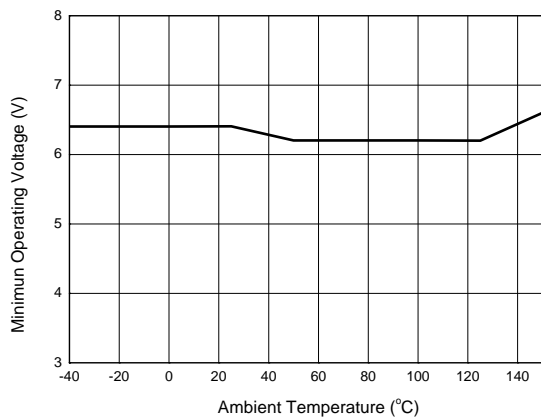

**Operating Current vs. Ambient Temperature**

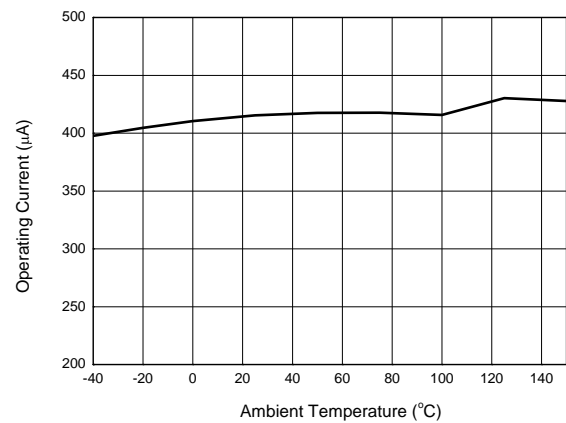

**Sink Resistance vs. Ambient Temperature**

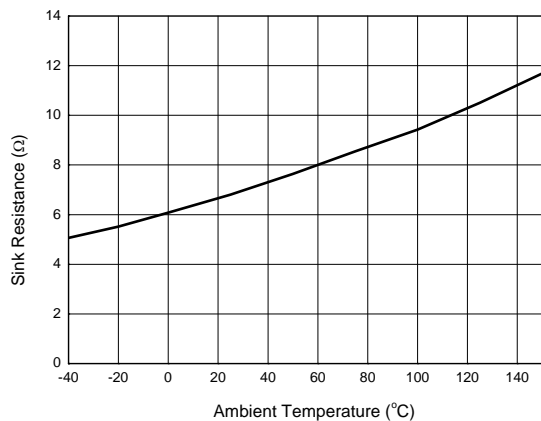

**Sample Time vs. Ambient Temperature**

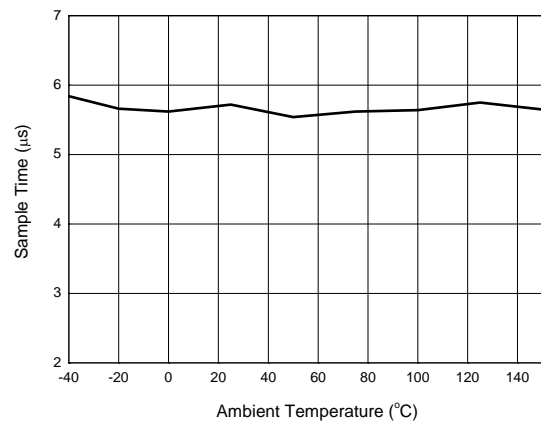

**Performance Characteristics (Cont.)**

**Feedback Voltage vs. Ambient Temperature**

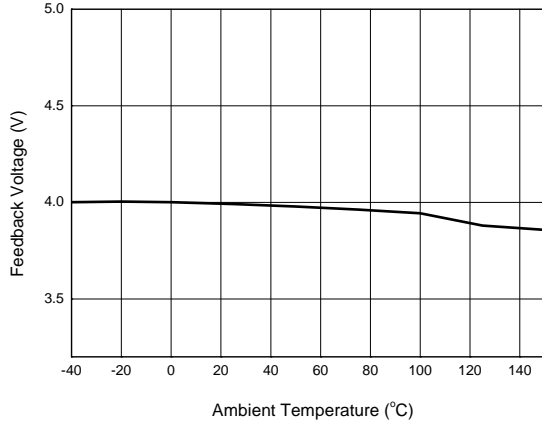

**Under Voltage of FB Pin vs. Ambient Temperature**

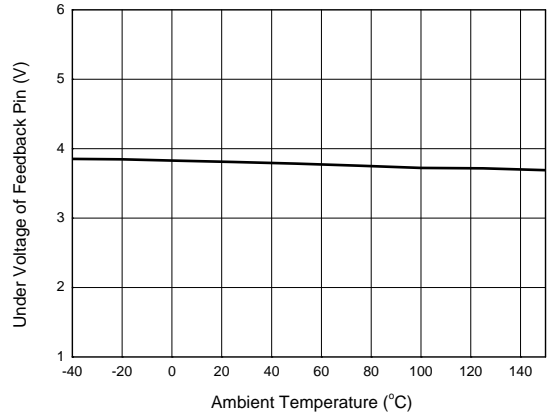

**Line Compensation Resistance vs. Ambient Temperature**

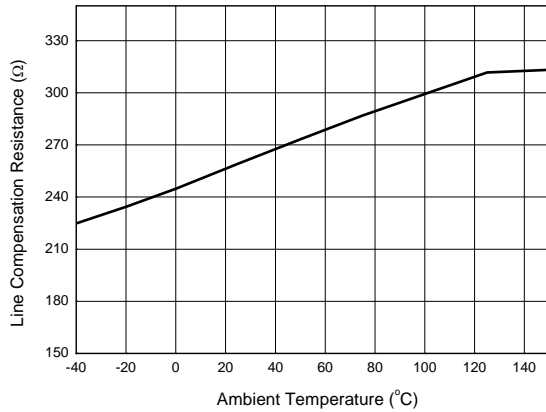

**Input Resistance of FB Pin vs. Ambient Temperature**

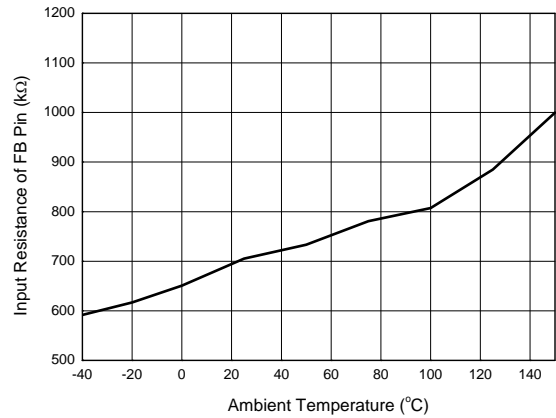





**Operation Principle Description (Cont.)**

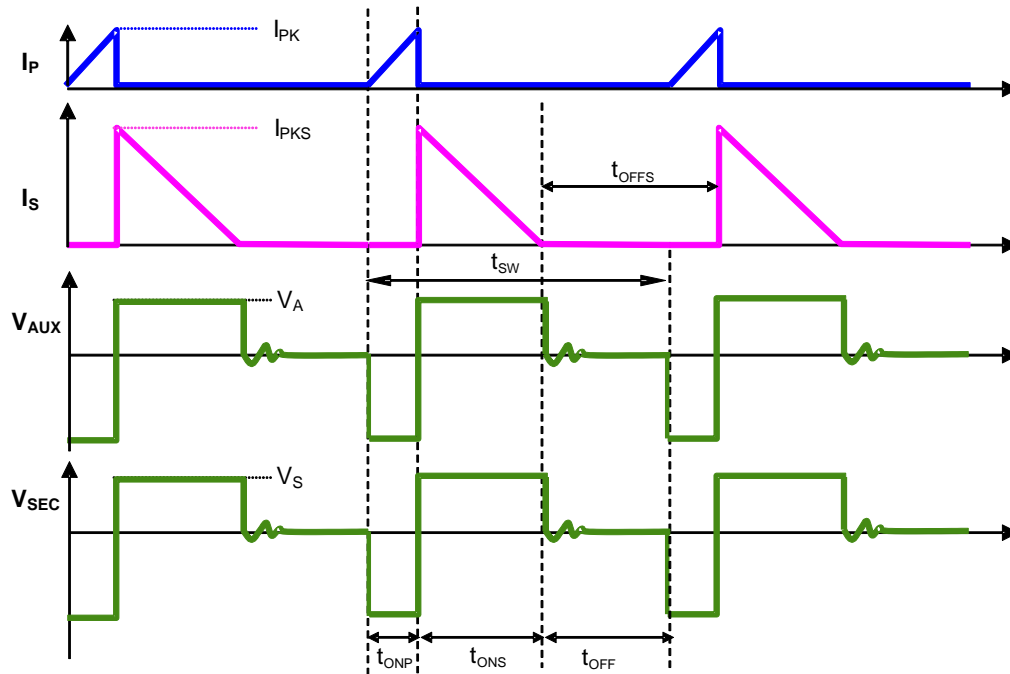

Figure 2. The Operation Waveform of Flyback PSR System

For primary-side regulation, the primary current  $i_p(t)$  is sensed by a current sense resistor  $R_{CS}$  (as shown in Figure 1). The current rises up linearly at a rate of:

$$\frac{di_p(t)}{dt} = \frac{V_{IN}(t)}{L_M} \quad (1)$$

As illustrated in Figure 2, when the current  $i_p(t)$  rises up to  $I_{PK}$ , the switch Q1 turns off. The constant peak current is given by:

$$I_{PK} = \frac{V_{CS}}{R_{CS}} \quad (2)$$

The energy stored in the magnetizing inductance  $L_M$  each cycle is therefore:

$$E_g = \frac{1}{2} \times L_M \cdot I_{PK}^2 \quad (3)$$

So the power transferring from the input to the output is given by:

$$P = \frac{1}{2} \times L_M \times I_{PK}^2 \times f_{SW} \quad (4)$$

Where, the  $f_{SW}$  is the switching frequency. When the peak current  $I_{PK}$  is constant, the output power depends on the switching frequency  $f_{SW}$ .

**Constant Voltage Operation**

As to constant-voltage (CV) operation mode, the AP3783 detects the auxiliary winding voltage at FB pin to regulate the output voltage. The auxiliary winding voltage is coupled with secondary side winding voltage, so the auxiliary winding voltage at D1 conduction time is:

$$V_{AUX} = \frac{N_{AUX}}{N_S} \times (V_O + V_D) \quad (5)$$

Where the  $V_D$  is the diode forward voltage drop.

**Operation Principle Description (Cont.)**

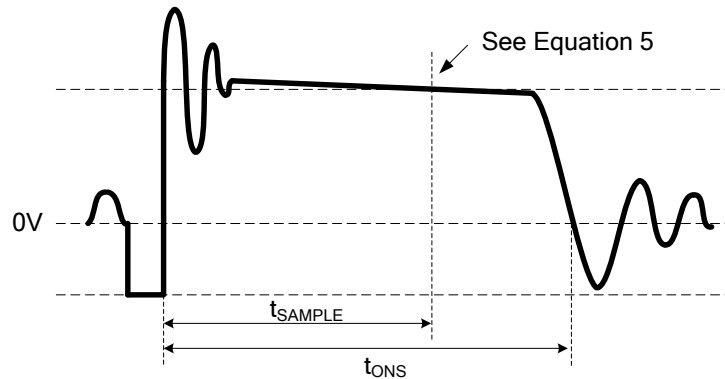

Figure 3. Auxiliary Voltage Waveform

The voltage detection point is at a constant delay time of the D1 on-time. The constant delay time is changed with the different primary peak current. The CV loop control function of AP3783 then generates a D1 off-time to regulate the output voltage.

**Constant Current Operation**

The AP3783 can work in constant-current (CC) mode. Figure 2 shows the secondary current waveforms.

In CC operation mode, the CC control loop of AP3783 will keep a fixed proportion between D1 on-time  $t_{ONS}$  and D1 off-time  $t_{OFFS}$ . The fixed proportion is

$$\frac{t_{ONS}}{t_{OFFS}} = \frac{4}{4} \tag{6}$$

The relationship between the output current and secondary peak current  $I_{PKS}$  is given by:

$$I_{OUT} = \frac{1}{2} \times I_{PKS} \times \frac{t_{ONS}}{t_{ONS} + t_{OFFS}} \tag{7}$$

As to tight coupled primary and secondary winding, the secondary peak current is

$$I_{PKS} = \frac{N_P}{N_S} \times I_{PK} \tag{8}$$

Thus the output constant-current is given by:

$$I_{OUT} = \frac{1}{2} \times \frac{N_P}{N_S} \times I_{PK} \times \frac{t_{ONS}}{t_{ONS} + t_{OFFS}} = \frac{2}{8} \times \frac{N_P}{N_S} \times I_{PK} \tag{9}$$

Therefore, AP3783 can realize CC mode operation by constant primary peak current and fixed diode conduction duty cycle.

**Multiple Segment Constant Peak Current**

As to the original PFM PSR system, the switching frequency decreases with output current decreasing, which will encounter audible noise issue since switching frequency decreases to audio frequency range, about less than 20kHz.

In order to avoid audible noise issue, AP3783 uses 4-segment constant primary peak current control method. At constant voltage mode, the current sense threshold voltage is multiple segments with different loading, as shown in Figure 4, which are  $V_{CS\_H}$  for high load,  $V_{CS\_M}$  for medium load,  $V_{CS\_L}$  for light load and  $V_{CS\_D}$  for ultra light load. At constant current mode, the peak current is still  $V_{CS\_H}$ .

**Operation Principle Description (Cont.)**

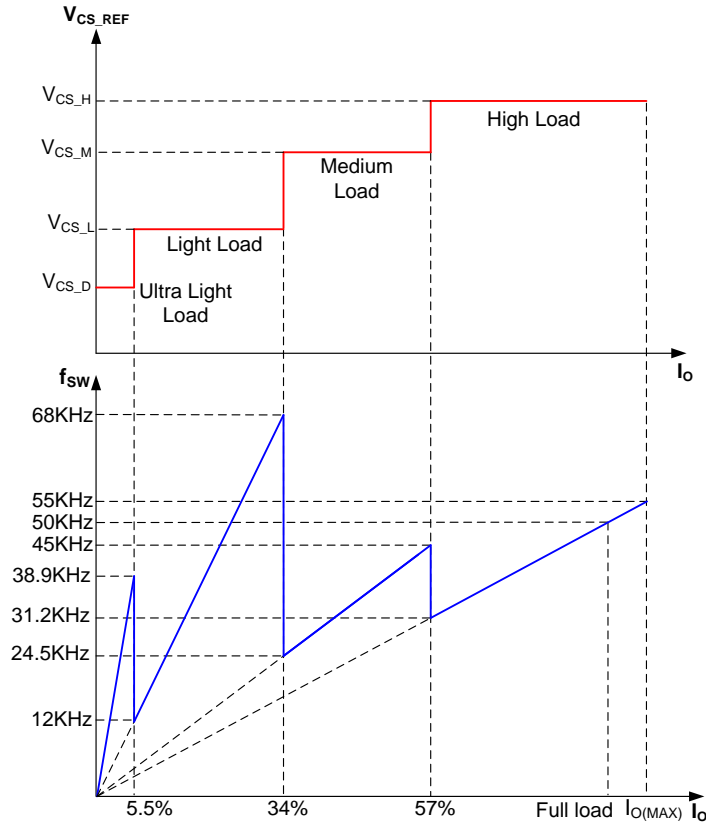

Figure 4. Multiple Segment Peak Current at CV Mode

It can be seen from Figure 4, with multiple segment peak current control, AP3783 power system can achieve good audible noise performance.

**3-Segment Drive Current for Radiative EMI Suppression**

When the power switch is turned on, a turn-on spike will occur, that worsens the radiative EMI. It is an effective way to decrease drive current before gate voltage gets to miller platform. The AP3783 uses 3-segment drive current for radiative EMI suppression, as shown in Figure 5. When gate voltage gets to 6V, the AP3783 drive current switches from low current (typical: 20mA) to high current (typical: 110mA). When the gate voltage gets to 10V, the drive current will decrease gradually to 0mA until the gate voltage goes up to the clamp voltage (13V).

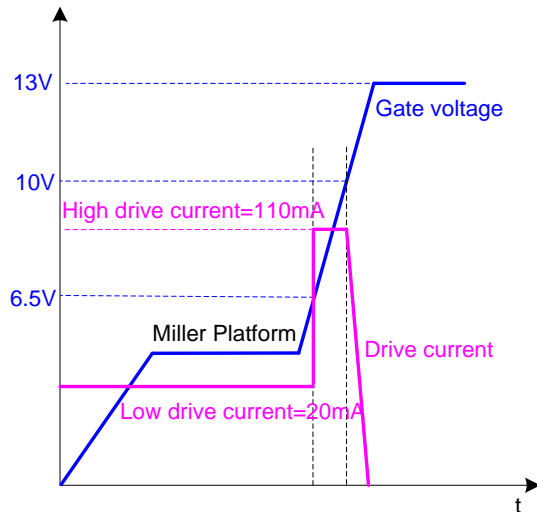

Figure 5. Drive Current and Gate Voltage

## Operation Principle Description (Cont.)

### Leading Edge Blanking (LEB) Time

When the power switch is turned on, a turn-on spike will occur on the sense-resistor. To avoid false turn off switch, a leading-edge blanking is built in. During this blanking time, the current sense comparator is disabled and the external power switch cannot be turned off. Furthermore, due to multiple segment peak current design, the required maximum on time  $t_{ONP}$  changes with different load conditions. Therefore the LEB time parameter also changes with different load conditions.

### Adjustable Line Compensation and Fixed Cable Compensation

The AP3783 power system can adjust line compensation by changing the upper resistor at FB pin. The line compensation capability is increased by decreasing the resistance of the upper FB resistor.

Cable compensation is fixed in AP3783.

### Valley Turn-on

When the off time ( $t_{OFF}$ ) is lower than  $16\mu s$ , AP3783 power system can work with valley turn-on. It can reduce MOSFET switching on power losses which is resulted from the equivalent output capacitance. At the same time, because of valley turn-on the switching frequency has the random jitter feature, which will be benefited for conductive EMI performance. And valley turn-on can also reduce the power switch turn-on spike current and then result in the better radiative EMI performance.

### Frequency Jitter

Even though the valley turn on function can lead the random frequency jitter feature, an active frequency jitter function is added to AP3783 to ensure the frequency jitter performance in the whole loading condition. By adjusting the  $V_{CS\_REF}$  with deviation of 5.0% every  $256\mu s$  cycle, the active frequency jitter can be realized.

### Short Circuit Protection (SCP)

Short Circuit Protection (SCP) detection principle is similar to the normal output voltage feedback detection by sensing FB pin voltage. When the detected FB pin voltage is below  $V_{FB(SCP)}$  for a duration of about 128ms, the SCP is triggered. Then the AP3783 enters hiccup mode that the IC immediately shuts down and then restarts, so that the VCC voltage changes between  $V_{TH\_ST}$  and UVLO threshold until  $V_{FB(SCP)}$  condition is removed.

As to the normal system startup, the time duration of FB pin voltage below  $V_{FB(SCP)}$  should be less than 18ms to avoid entering SCP mode. But for the output short condition or the output voltage below a certain level, the SCP mode will be triggered.

Figure 6 is the AP3783 normal start-up waveform that the voltage of FB pin is above  $V_{FB(SCP)}$  during  $t_{SCP}$  after  $V_{CC}$  gets to the  $V_{TH\_ST}$ , which doesn't enter the SCP mode. As shown in Figure 7,  $V_{OUT}$  is short and the voltage of FB pin is lower than  $V_{FB(SCP)}$  during  $t_{SCP}$ , the AP3783 triggers the SCP and enters the hiccup mode.

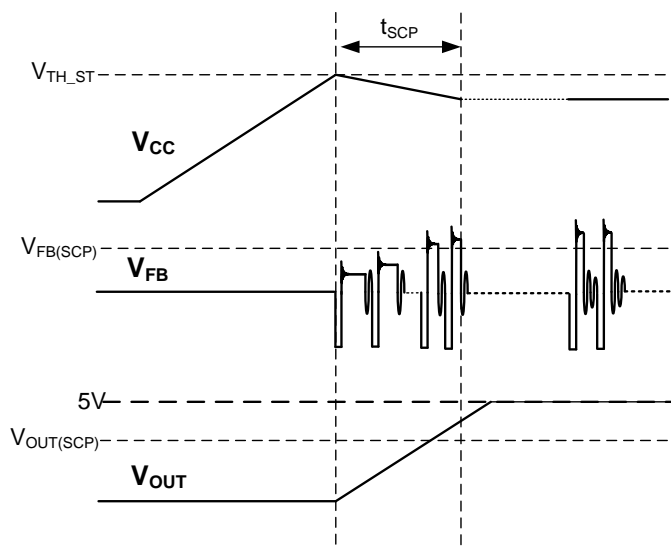

Figure 6. Normal Start-up

**Operation Principle Description (Cont.)**

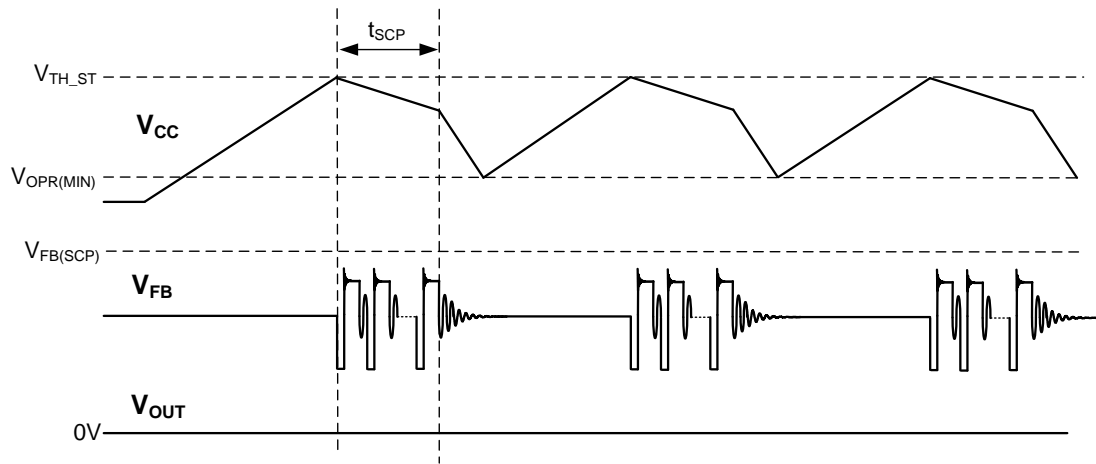

Figure 7. Short Circuit Protection (SCP) and Hiccup Mode

**OVP**

The AP3783 includes output over-voltage protection (OVP). If the voltage at FB pin exceeds  $V_{FB(OVP)}$ , the AP3783 immediately shuts down and keeps the internal circuitry enabled to discharge the VCC capacitor to the UVLO turn-off threshold. After that, the device returns to the start state and a start-up sequence ensues.

**OTP**

If the junction temperature reaches the threshold of +160°C, AP3783 shuts down immediately. Before VCC voltage decreases to UVLO, if the junction temperature decreases to +120°C, AP3783 can recover to normal operation. If not, the power system enters restart Hiccup mode until the junction temperature decreases below +120°C.

**Ordering Information**

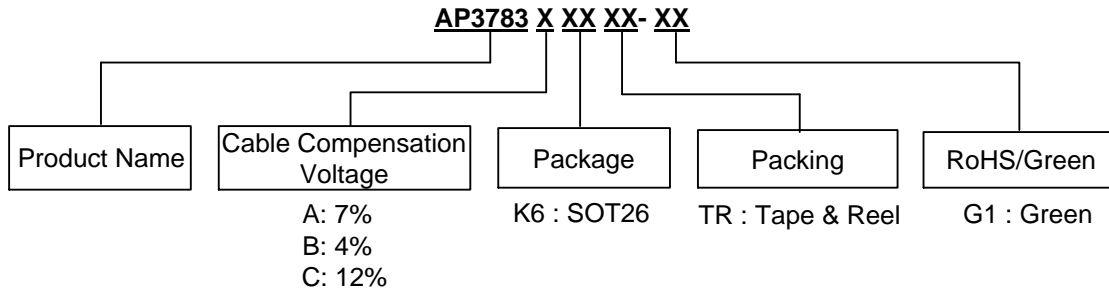

| Package | Temperature Range | Cable Compensation Voltage | Part Number    | Marking ID | Packing          |
|---------|-------------------|----------------------------|----------------|------------|------------------|
| SOT26   | -40 to +85°C      | 7%                         | AP3783AK6TR-G1 | GBZ        | 3000/Tape & Reel |
|         |                   | 4%                         | AP3783BK6TR-G1 | GNZ        | 3000/Tape & Reel |
|         |                   | 12%                        | AP3783CK6TR-G1 | GPZ        | 3000/Tape & Reel |

**Marking Information**

(Top View)

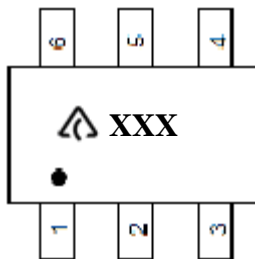

 : Logo  
**XXX**: Marking ID (See Ordering Information)

**Package Outline Dimensions** (All dimensions in mm(inch).)

(1) Package Type: SOT26

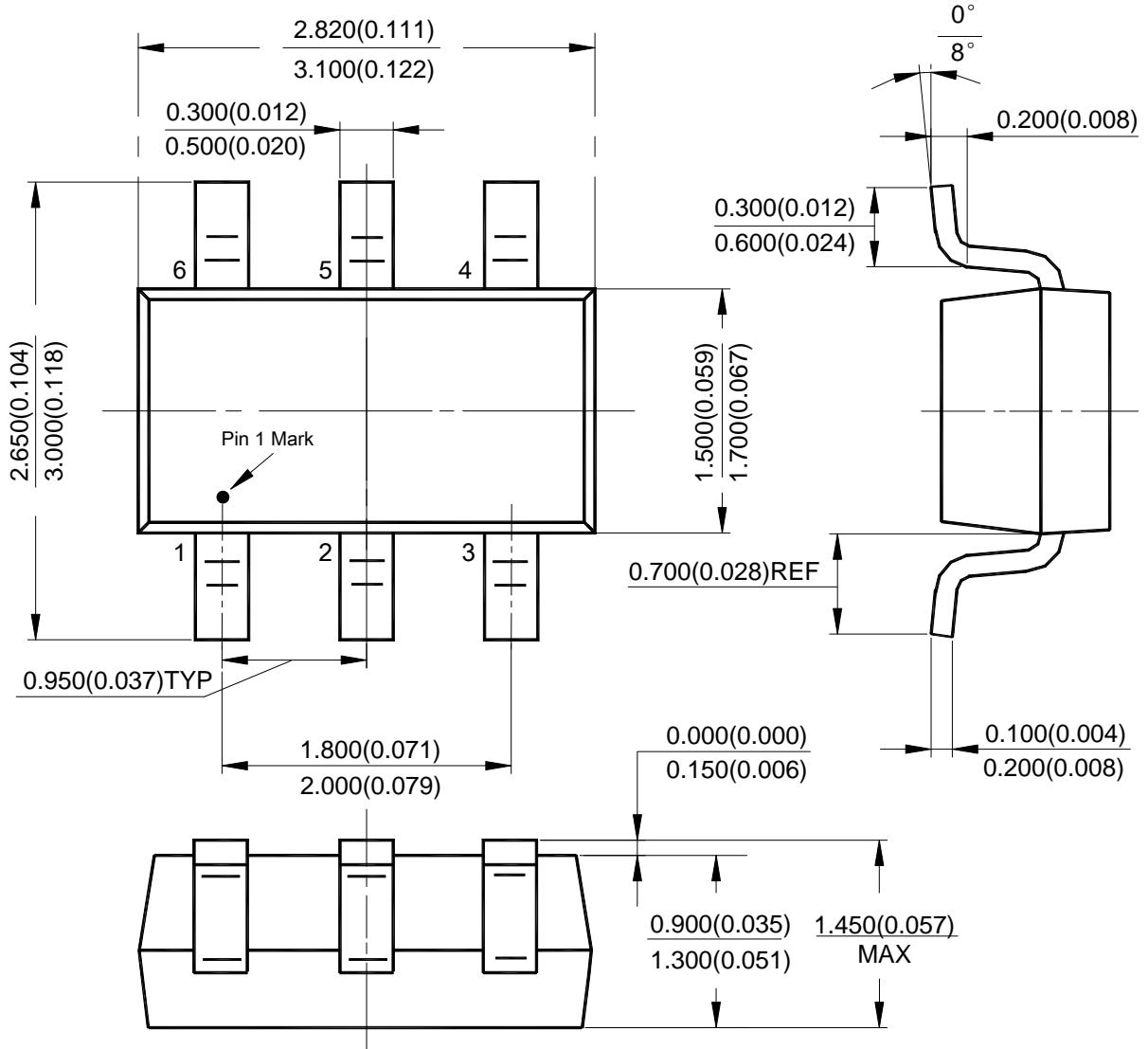

**Suggested Pad Layout**

(1) Package Type: SOT26

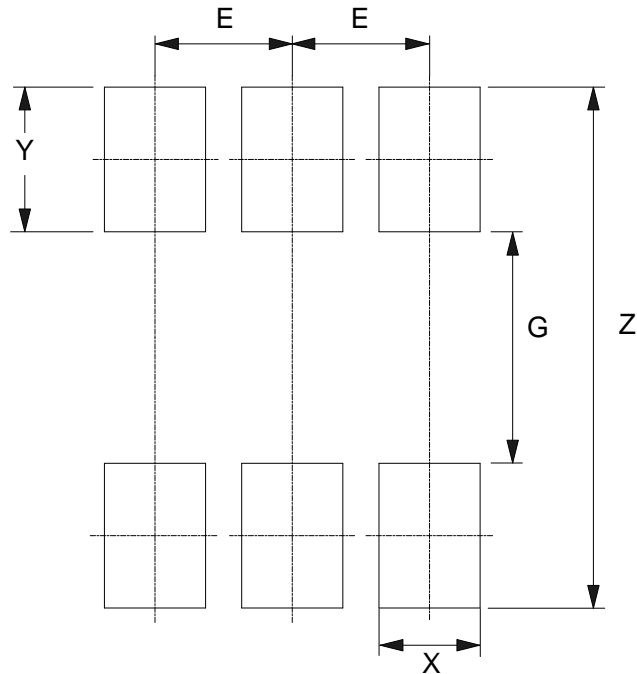

| Dimensions | Z<br>(mm)/(inch) | G<br>(mm)/(inch) | X<br>(mm)/(inch) | Y<br>(mm)/(inch) | E<br>(mm)/(inch) |
|------------|------------------|------------------|------------------|------------------|------------------|
| Value      | 3.600/0.142      | 1.600/0.063      | 0.700/0.028      | 1.000/0.039      | 0.950/0.037      |



**IMPORTANT NOTICE**

DIODES INCORPORATED MAKES NO WARRANTY OF ANY KIND, EXPRESS OR IMPLIED, WITH REGARDS TO THIS DOCUMENT, INCLUDING, BUT NOT LIMITED TO, THE IMPLIED WARRANTIES OF MERCHANTABILITY AND FITNESS FOR A PARTICULAR PURPOSE (AND THEIR EQUIVALENTS UNDER THE LAWS OF ANY JURISDICTION).

Diodes Incorporated and its subsidiaries reserve the right to make modifications, enhancements, improvements, corrections or other changes without further notice to this document and any product described herein. Diodes Incorporated does not assume any liability arising out of the application or use of this document or any product described herein; neither does Diodes Incorporated convey any license under its patent or trademark rights, nor the rights of others. Any Customer or user of this document or products described herein in such applications shall assume all risks of such use and will agree to hold Diodes Incorporated and all the companies whose products are represented on Diodes Incorporated website, harmless against all damages.

Diodes Incorporated does not warrant or accept any liability whatsoever in respect of any products purchased through unauthorized sales channel. Should Customers purchase or use Diodes Incorporated products for any unintended or unauthorized application, Customers shall indemnify and hold Diodes Incorporated and its representatives harmless against all claims, damages, expenses, and attorney fees arising out of, directly or indirectly, any claim of personal injury or death associated with such unintended or unauthorized application.

Products described herein may be covered by one or more United States, international or foreign patents pending. Product names and markings noted herein may also be covered by one or more United States, international or foreign trademarks.

This document is written in English but may be translated into multiple languages for reference. Only the English version of this document is the final and determinative format released by Diodes Incorporated.

**LIFE SUPPORT**

Diodes Incorporated products are specifically not authorized for use as critical components in life support devices or systems without the express written approval of the Chief Executive Officer of Diodes Incorporated. As used herein:

A. Life support devices or systems are devices or systems which:

1. are intended to implant into the body, or
2. support or sustain life and whose failure to perform when properly used in accordance with instructions for use provided in the labeling can be reasonably expected to result in significant injury to the user.

B. A critical component is any component in a life support device or system whose failure to perform can be reasonably expected to cause the failure of the life support device or to affect its safety or effectiveness.

Customers represent that they have all necessary expertise in the safety and regulatory ramifications of their life support devices or systems, and acknowledge and agree that they are solely responsible for all legal, regulatory and safety-related requirements concerning their products and any use of Diodes Incorporated products in such safety-critical, life support devices or systems, notwithstanding any devices- or systems-related information or support that may be provided by Diodes Incorporated. Further, Customers must fully indemnify Diodes Incorporated and its representatives against any damages arising out of the use of Diodes Incorporated products in such safety-critical, life support devices or systems.

Copyright © 2016, Diodes Incorporated

[www.diodes.com](http://www.diodes.com)

Компания «Океан Электроники» предлагает заключение долгосрочных отношений при поставках импортных электронных компонентов на взаимовыгодных условиях!

Наши преимущества:

- Поставка оригинальных импортных электронных компонентов напрямую с производств Америки, Европы и Азии, а так же с крупнейших складов мира;
- Широкая линейка поставок активных и пассивных импортных электронных компонентов (более 30 млн. наименований);
- Поставка сложных, дефицитных, либо снятых с производства позиций;
- Оперативные сроки поставки под заказ (от 5 рабочих дней);
- Экспресс доставка в любую точку России;
- Помощь Конструкторского Отдела и консультации квалифицированных инженеров;
- Техническая поддержка проекта, помощь в подборе аналогов, поставка прототипов;
- Поставка электронных компонентов под контролем ВП;
- Система менеджмента качества сертифицирована по Международному стандарту ISO 9001;
- При необходимости вся продукция военного и аэрокосмического назначения проходит испытания и сертификацию в лаборатории (по согласованию с заказчиком);
- Поставка специализированных компонентов военного и аэрокосмического уровня качества (Xilinx, Altera, Analog Devices, Intersil, Interpoint, Microsemi, Actel, Aeroflex, Peregrine, VPT, Syfer, Eurofarad, Texas Instruments, MS Kennedy, Miteq, Cobham, E2V, MA-COM, Hittite, Mini-Circuits, General Dynamics и др.);

Компания «Океан Электроники» является официальным дистрибьютором и эксклюзивным представителем в России одного из крупнейших производителей разъемов военного и аэрокосмического назначения «**JONHON**», а так же официальным дистрибьютором и эксклюзивным представителем в России производителя высокотехнологичных и надежных решений для передачи СВЧ сигналов «**FORSTAR**».



## JONHON

«**JONHON**» (основан в 1970 г.)

Разъемы специального, военного и аэрокосмического назначения:

(Применяются в военной, авиационной, аэрокосмической, морской, железнодорожной, горно- и нефтедобывающей отраслях промышленности)

«**FORSTAR**» (основан в 1998 г.)

ВЧ соединители, коаксиальные кабели,  
кабельные сборки и микроволновые компоненты:

(Применяются в телекоммуникациях гражданского и специального назначения, в средствах связи, РЛС, а так же военной, авиационной и аэрокосмической отраслях промышленности).



Телефон: 8 (812) 309-75-97 (многоканальный)

Факс: 8 (812) 320-03-32

Электронная почта: [ocean@oceanchips.ru](mailto:ocean@oceanchips.ru)

Web: <http://oceanchips.ru/>

Адрес: 198099, г. Санкт-Петербург, ул. Калинина, д. 2, корп. 4, лит. А