



## Ultrabright LED, Ø 5 mm Untinted Non-Diffused Package



19223

### DESCRIPTION

The TLC.51.. series is a clear, non-diffused 5 mm LED for high end applications where supreme luminous intensity required.

These lamps with clear untinted plastic case utilize the highly developed ultrabright AlInGaP (AS).

The lens and the viewing angle is optimized to achieve best performance of light output and visibility.

### PRODUCT GROUP AND PACKAGE DATA

- Product group: LED
- Package: 5 mm
- Product series: power
- Angle of half intensity:  $\pm 9^\circ$

### FEATURES

- Untinted non-diffused lens
- Utilizing ultrabright AlInGaP (AS)
- High luminous intensity
- High operating temperature:  $T_j$  (chip junction temperature) up to 125 °C for AlInGaP devices
- Luminous intensity and color categorized for each packing unit
- ESD-withstand voltage: up to 2 kV according to JESD22-A114-B
- Material categorization: for definitions of compliance please see [www.vishay.com/doc?99912](http://www.vishay.com/doc?99912)



### APPLICATIONS

- Interior and exterior lighting
- Outdoor LED panels
- Instrumentation and front panel indicators
- Central high mounted stop lights (CHMSL) for motor vehicles
- Replaces incandescent lamps
- Traffic signals
- Light guide design

| PARTS TABLE   |              |                          |        |        |               |                 |      |      |               |                     |      |      |               |                 |
|---------------|--------------|--------------------------|--------|--------|---------------|-----------------|------|------|---------------|---------------------|------|------|---------------|-----------------|
| PART          | COLOR        | LUMINOUS INTENSITY (mcd) |        |        | at $I_F$ (mA) | WAVELENGTH (nm) |      |      | at $I_F$ (mA) | FORWARD VOLTAGE (V) |      |      | at $I_F$ (mA) | TECHNOLOGY      |
|               |              | MIN.                     | TYP.   | MAX.   |               | MIN.            | TYP. | MAX. |               | MIN.                | TYP. | MAX. |               |                 |
| TLCS5100      | Super red    | 2400                     | 7500   | -      | 50            | 626             | 630  | 638  | 50            | -                   | 2.1  | 2.7  | 50            | AllnGaP on GaAs |
| TCR5100       | Red          | 4300                     | 11 000 | -      | 50            | 611             | 616  | 622  | 50            | -                   | 2.1  | 2.7  | 50            | AllnGaP on GaAs |
| TCO5100       | Soft orange  | 4300                     | 12 000 | -      | 50            | 600             | 605  | 611  | 50            | -                   | 2.1  | 2.7  | 50            | AllnGaP on GaAs |
| TLY5100       | Yellow       | 3200                     | 7500   | -      | 50            | 585             | 590  | 597  | 50            | -                   | 2.1  | 2.7  | 50            | AllnGaP on GaAs |
| TLY5100-ASZ   | Yellow       | 3200                     | 7500   | -      | 50            | 585             | 590  | 597  | 50            | -                   | 2.1  | 2.7  | 50            | AllnGaP on GaAs |
| TLY5101-AS12Z | Yellow       | 5750                     | -      | 20 000 | 50            | 585             | 590  | 597  | 50            | -                   | 2.1  | 2.7  | 50            | AllnGaP on GaAs |
| TLYG5100      | Yellow green | 1350                     | 3500   | -      | 50            | 565             | 572  | 576  | 50            | -                   | 2.2  | 2.7  | 50            | AllnGaP on GaAs |
| TLCPG5100     | Pure green   | 430                      | 1250   | -      | 50            | 555             | 562  | 567  | 50            | -                   | 2.1  | 2.7  | 50            | AllnGaP on GaAs |

| ABSOLUTE MAXIMUM RATINGS ( $T_{amb} = 25^\circ\text{C}$ , unless otherwise specified)<br>TLCS510., TCR510., TCO510., TLY510., TLYG510., TLCPG510. |                                       |            |             |      |
|---|---------------------------------------|------------|-------------|------|
| PARAMETER   | TEST CONDITION                        | SYMBOL     | VALUE       | UNIT |
| Reverse voltage <sup>(1)</sup>  |                                       | $V_R$      | 5           | V    |
| DC forward current  | $T_{amb} \leq 85^\circ\text{C}$       | $I_F$      | 50          | mA   |
| Surge forward current   | $t_p \leq 10 \mu\text{s}$             | $I_{FSM}$  | 1           | A    |
| Power dissipation   |                                       | $P_V$      | 135         | mW   |
| Junction temperature  |                                       | $T_j$      | 125         | °C   |
| Operating temperature range   |                                       | $T_{amb}$  | -40 to +100 | °C   |
| Storage temperature range   |                                       | $T_{stg}$  | -40 to +100 | °C   |
| Soldering temperature   | $t \leq 5 \text{ s}$ , 2 mm from body | $T_{sd}$   | 260         | °C   |
| Thermal resistance junction/ambient   |                                       | $R_{thJA}$ | 300         | K/W  |

#### Note

<sup>(1)</sup> Driving the LED in reverse direction is suitable for a short term application



| <b>OPTICAL AND ELECTRICAL CHARACTERISTICS</b> ( $T_{amb} = 25\text{ }^{\circ}\text{C}$ , unless otherwise specified) |                               |          |                  |      |         |      |      |
|--|-------------------------------|----------|------------------|------|---------|------|------|
| <b>TLCS5100, SUPER RED</b>   |                               |          |                  |      |         |      |      |
| PARAMETER  | TEST CONDITION                | PART     | SYMBOL           | MIN. | TYP.    | MAX. | UNIT |
| Luminous intensity <sup>(1)</sup>  | $I_F = 50\text{ mA}$          | TLCS5100 | $I_V$            | 2400 | 7500    | -    | mcd  |
| Dominant wavelength  | $I_F = 50\text{ mA}$          |          | $\lambda_d$      | 626  | 630     | 638  | nm   |
| Peak wavelength  | $I_F = 50\text{ mA}$          |          | $\lambda_p$      | -    | 641     | -    | nm   |
| Spectral bandwidth at 50 % $I_{rel\ max.}$   | $I_F = 50\text{ mA}$          |          | $\Delta\lambda$  | -    | 20      | -    | nm   |
| Angle of half intensity  | $I_F = 50\text{ mA}$          |          | $\phi$           | -    | $\pm 9$ | -    | deg  |
| Forward voltage  | $I_F = 50\text{ mA}$          |          | $V_F$            | -    | 2.1     | 2.7  | V    |
| Reverse voltage  | $I_R = 10\text{ }\mu\text{A}$ |          | $V_R$            | 5    | -       | -    | V    |
| Temperature coefficient of $V_F$   | $I_F = 50\text{ mA}$          |          | $TC_{V_F}$       | -    | -2      | -    | mV/K |
| Temperature coefficient of $\lambda_d$   | $I_F = 50\text{ mA}$          |          | $TC_{\lambda_d}$ | -    | 0.04    | -    | nm/K |

**Note**

<sup>(1)</sup> In one packing unit  $I_{Vmax.}/I_{Vmin.} \leq 2.0$

| <b>OPTICAL AND ELECTRICAL CHARACTERISTICS</b> ( $T_{amb} = 25\text{ }^{\circ}\text{C}$ , unless otherwise specified) |                               |          |                  |      |         |      |      |
|--|-------------------------------|----------|------------------|------|---------|------|------|
| <b>TLCR5100, RED</b>   |                               |          |                  |      |         |      |      |
| PARAMETER  | TEST CONDITION                | PART     | SYMBOL           | MIN. | TYP.    | MAX. | UNIT |
| Luminous intensity <sup>(1)</sup>  | $I_F = 50\text{ mA}$          | TLCR5100 | $I_V$            | 4300 | 11 000  | -    | mcd  |
| Dominant wavelength  | $I_F = 50\text{ mA}$          |          | $\lambda_d$      | 611  | 616     | 622  | nm   |
| Peak wavelength  | $I_F = 50\text{ mA}$          |          | $\lambda_p$      | -    | 622     | -    | nm   |
| Spectral bandwidth at 50 % $I_{rel\ max.}$   | $I_F = 50\text{ mA}$          |          | $\Delta\lambda$  | -    | 18      | -    | nm   |
| Angle of half intensity  | $I_F = 50\text{ mA}$          |          | $\phi$           | -    | $\pm 9$ | -    | deg  |
| Forward voltage  | $I_F = 50\text{ mA}$          |          | $V_F$            | -    | 2.1     | 2.7  | V    |
| Reverse voltage  | $I_R = 10\text{ }\mu\text{A}$ |          | $V_R$            | 5    | -       | -    | V    |
| Temperature coefficient of $V_F$   | $I_F = 50\text{ mA}$          |          | $TC_{V_F}$       | -    | -3.5    | -    | mV/K |
| Temperature coefficient of $\lambda_d$   | $I_F = 50\text{ mA}$          |          | $TC_{\lambda_d}$ | -    | 0.05    | -    | nm/K |

**Note**

<sup>(1)</sup> In one packing unit  $I_{Vmax.}/I_{Vmin.} \leq 2.0$

| <b>OPTICAL AND ELECTRICAL CHARACTERISTICS</b> ( $T_{amb} = 25\text{ }^{\circ}\text{C}$ , unless otherwise specified) |                               |          |                  |      |         |      |      |
|--|-------------------------------|----------|------------------|------|---------|------|------|
| <b>TLCO5100, SOFT ORANGE</b>   |                               |          |                  |      |         |      |      |
| PARAMETER  | TEST CONDITION                | PART     | SYMBOL           | MIN. | TYP.    | MAX. | UNIT |
| Luminous intensity <sup>(1)</sup>  | $I_F = 50\text{ mA}$          | TLCO5100 | $I_V$            | 4300 | 12 000  | -    | mcd  |
| Dominant wavelength  | $I_F = 50\text{ mA}$          |          | $\lambda_d$      | 600  | 605     | 611  | nm   |
| Peak wavelength  | $I_F = 50\text{ mA}$          |          | $\lambda_p$      | -    | 611     | -    | nm   |
| Spectral bandwidth at 50 % $I_{rel\ max.}$   | $I_F = 50\text{ mA}$          |          | $\Delta\lambda$  | -    | 17      | -    | nm   |
| Angle of half intensity  | $I_F = 50\text{ mA}$          |          | $\phi$           | -    | $\pm 9$ | -    | deg  |
| Forward voltage  | $I_F = 50\text{ mA}$          |          | $V_F$            | -    | 2.1     | 2.7  | V    |
| Reverse voltage  | $I_R = 10\text{ }\mu\text{A}$ |          | $V_R$            | 5    | -       | -    | V    |
| Temperature coefficient of $V_F$   | $I_F = 50\text{ mA}$          |          | $TC_{V_F}$       | -    | -2.5    | -    | mV/K |
| Temperature coefficient of $\lambda_d$   | $I_F = 50\text{ mA}$          |          | $TC_{\lambda_d}$ | -    | 0.1     | -    | nm/K |

**Note**

<sup>(1)</sup> In one packing unit  $I_{Vmax.}/I_{Vmin.} \leq 2.0$



| <b>OPTICAL AND ELECTRICAL CHARACTERISTICS</b> ( $T_{amb} = 25\text{ }^{\circ}\text{C}$ , unless otherwise specified) |                               |          |                  |      |         |        |      |
|--|-------------------------------|----------|------------------|------|---------|--------|------|
| <b>TLCY5100, TLCY5101, YELLOW</b>  |                               |          |                  |      |         |        |      |
| PARAMETER  | TEST CONDITION                | PART     | SYMBOL           | MIN. | TYP.    | MAX.   | UNIT |
| Luminous intensity <sup>(1)</sup>  | $I_F = 50\text{ mA}$          | TLCY5100 | $I_V$            | 3200 | 7500    | -      | mcd  |
|  |                               | TLCY5101 | $I_V$            | 5750 | -       | 20 000 | mcd  |
| Dominant wavelength  | $I_F = 50\text{ mA}$          |          | $\lambda_d$      | 585  | 590     | 597    | nm   |
| Peak wavelength  | $I_F = 50\text{ mA}$          |          | $\lambda_p$      | -    | 593     | -      | nm   |
| Spectral bandwidth at 50 % $I_{rel\ max.}$   | $I_F = 50\text{ mA}$          |          | $\Delta\lambda$  | -    | 17      | -      | nm   |
| Angle of half intensity  | $I_F = 50\text{ mA}$          |          | $\phi$           | -    | $\pm 9$ | -      | deg  |
| Forward voltage  | $I_F = 50\text{ mA}$          |          | $V_F$            | -    | 2.1     | 2.7    | V    |
| Reverse voltage  | $I_R = 10\text{ }\mu\text{A}$ |          | $V_R$            | 5    | -       | -      | V    |
| Temperature coefficient of $V_F$   | $I_F = 50\text{ mA}$          |          | $TC_{V_F}$       | -    | -3.5    | -      | mV/K |
| Temperature coefficient of $\lambda_d$   | $I_F = 50\text{ mA}$          |          | $TC_{\lambda_d}$ | -    | 0.1     | -      | nm/K |

**Note**

<sup>(1)</sup> In one packing unit  $I_{Vmax.}/I_{Vmin.} \leq 2.0$

| <b>OPTICAL AND ELECTRICAL CHARACTERISTICS</b> ( $T_{amb} = 25\text{ }^{\circ}\text{C}$ , unless otherwise specified) |                               |           |                  |      |         |      |      |
|--|-------------------------------|-----------|------------------|------|---------|------|------|
| <b>TLCYG5100, YELLOW GREEN</b>   |                               |           |                  |      |         |      |      |
| PARAMETER  | TEST CONDITION                | PART      | SYMBOL           | MIN. | TYP.    | MAX. | UNIT |
| Luminous intensity <sup>(1)</sup>  | $I_F = 50\text{ mA}$          | TLCYG5100 | $I_V$            | 1350 | 3500    | -    | mcd  |
| Dominant wavelength  | $I_F = 50\text{ mA}$          |           | $\lambda_d$      | 565  | 572     | 576  | nm   |
| Peak wavelength  | $I_F = 50\text{ mA}$          |           | $\lambda_p$      | -    | 574     | -    | nm   |
| Spectral bandwidth at 50 % $I_{rel\ max.}$   | $I_F = 50\text{ mA}$          |           | $\Delta\lambda$  | -    | 15      | -    | nm   |
| Angle of half intensity  | $I_F = 50\text{ mA}$          |           | $\phi$           | -    | $\pm 9$ | -    | deg  |
| Forward voltage  | $I_F = 50\text{ mA}$          |           | $V_F$            | -    | 2.2     | 2.7  | V    |
| Reverse voltage  | $I_R = 10\text{ }\mu\text{A}$ |           | $V_R$            | 5    | -       | -    | V    |
| Temperature coefficient of $V_F$   | $I_F = 50\text{ mA}$          |           | $TC_{V_F}$       | -    | -4.5    | -    | mV/K |
| Temperature coefficient of $\lambda_d$   | $I_F = 50\text{ mA}$          |           | $TC_{\lambda_d}$ | -    | 0.1     | -    | nm/K |

**Note**

<sup>(1)</sup> In one packing unit  $I_{Vmax.}/I_{Vmin.} \leq 2.0$

| <b>OPTICAL AND ELECTRICAL CHARACTERISTICS</b> ( $T_{amb} = 25\text{ }^{\circ}\text{C}$ , unless otherwise specified) |                               |           |                  |      |         |      |      |
|--|-------------------------------|-----------|------------------|------|---------|------|------|
| <b>TLCPG5100, PURE GREEN</b>   |                               |           |                  |      |         |      |      |
| PARAMETER  | TEST CONDITION                | PART      | SYMBOL           | MIN. | TYP.    | MAX. | UNIT |
| Luminous intensity <sup>(1)</sup>  | $I_F = 50\text{ mA}$          | TLCPG5100 | $I_V$            | 430  | 1250    | -    | mcd  |
| Dominant wavelength  | $I_F = 50\text{ mA}$          |           | $\lambda_d$      | 555  | 562     | 567  | nm   |
| Peak wavelength  | $I_F = 50\text{ mA}$          |           | $\lambda_p$      | -    | 563     | -    | nm   |
| Spectral bandwidth at 50 % $I_{rel\ max.}$   | $I_F = 50\text{ mA}$          |           | $\Delta\lambda$  | -    | 20      | -    | nm   |
| Angle of half intensity  | $I_F = 50\text{ mA}$          |           | $\phi$           | -    | $\pm 9$ | -    | deg  |
| Forward voltage  | $I_F = 50\text{ mA}$          |           | $V_F$            | -    | 2.1     | 2.7  | V    |
| Reverse voltage  | $I_R = 10\text{ }\mu\text{A}$ |           | $V_R$            | 5    | -       | -    | V    |
| Temperature coefficient of $V_F$   | $I_F = 50\text{ mA}$          |           | $TC_{V_F}$       | -    | -3.5    | -    | mV/K |
| Temperature coefficient of $\lambda_d$   | $I_F = 50\text{ mA}$          |           | $TC_{\lambda_d}$ | -    | 0.1     | -    | nm/K |

**Note**

<sup>(1)</sup> In one packing unit  $I_{Vmax.}/I_{Vmin.} \leq 2.0$



| <b>LUMINOUS INTENSITY CLASSIFICATION</b> |                                 |             |
|--|---------------------------------|-------------|
| <b>GROUP</b>                             | <b>LUMINOUS INTENSITY (mcd)</b> |             |
|  | <b>MIN.</b>                     | <b>MAX.</b> |
| <b>STANDARD</b>                          |                                 |             |
| BB                                       | 430                             | 860         |
| CC                                       | 575                             | 1150        |
| DD                                       | 750                             | 1500        |
| EE                                       | 1000                            | 2000        |
| FF                                       | 1350                            | 2700        |
| GG                                       | 1800                            | 3600        |
| HH                                       | 2400                            | 4800        |
| II                                       | 3200                            | 6400        |
| KK                                       | 4300                            | 8600        |
| LL                                       | 5750                            | 11 500      |
| MM                                       | 7500                            | 15 000      |
| NN                                       | 10 000                          | 20 000      |
| PP                                       | 13 500                          | 27 000      |
| QQ                                       | 18 000                          | 36 000      |
| RR                                       | 24 000                          | 48 000      |
| SS                                       | 32 000                          | 64 000      |
| TT                                       | 43 000                          | 86 000      |
| UU                                       | 57 500                          | 115 000     |

**Note**

- Luminous intensity is tested at a current pulse duration of 25 ms and an accuracy of  $\pm 11\%$ .  
The above type numbers represent the order groups which include only a few brightness groups. Only one group will be shipped on each bag (there will be no mixing of two groups on each bag).  
In order to ensure availability, single brightness groups will not be orderable.  
In a similar manner for colors where wavelength groups are measured and binned, single wavelength groups will be shipped in any one bag.  
In order to ensure availability, single wavelength groups will not be orderable.

| <b>COLOR CLASSIFICATION</b> |                             |             |                    |             |               |             |                     |             |                   |             |
|-----------------------------|-----------------------------|-------------|--------------------|-------------|---------------|-------------|---------------------|-------------|-------------------|-------------|
| <b>GROUP</b>                | <b>DOM. WAVELENGTH (nm)</b> |             |                    |             |               |             |                     |             |                   |             |
|                             | <b>RED</b>                  |             | <b>SOFT ORANGE</b> |             | <b>YELLOW</b> |             | <b>YELLOW GREEN</b> |             | <b>PURE GREEN</b> |             |
|                             | <b>MIN.</b>                 | <b>MAX.</b> | <b>MIN.</b>        | <b>MAX.</b> | <b>MIN.</b>   | <b>MAX.</b> | <b>MIN.</b>         | <b>MAX.</b> | <b>MIN.</b>       | <b>MAX.</b> |
| 0                           | -                           | -           | -                  | -           | 585           | 588         | -                   | -           | 555               | 559         |
| 1                           | 611                         | 618         | -                  | -           | 587           | 591         | -                   | -           | 558               | 561         |
| 2                           | 614                         | 622         | 600                | 603         | 589           | 594         | -                   | -           | 560               | 563         |
| 3                           | -                           | -           | 602                | 605         | 592           | 597         | -                   | -           | 562               | 565         |
| 4                           | -                           | -           | 604                | 607         | -             | -           | -                   | -           | 564               | 567         |
| 5                           | -                           | -           | 606                | 609         | -             | -           | 565                 | 570         | -                 | -           |
| 6                           | -                           | -           | 608                | 611         | -             | -           | 567                 | 572         | -                 | -           |
| 7                           | -                           | -           | -                  | -           | -             | -           | 569                 | 574         | -                 | -           |
| 8                           | -                           | -           | -                  | -           | -             | -           | 571                 | 576         | -                 | -           |

**Note**

- Wavelengths are tested at a current pulse duration of 25 ms and an accuracy of  $\pm 1$  nm.

**TYPICAL CHARACTERISTICS** ( $T_{amb} = 25\text{ }^{\circ}\text{C}$ , unless otherwise specified)



Fig. 1 - Forward Current vs. Ambient Temperature

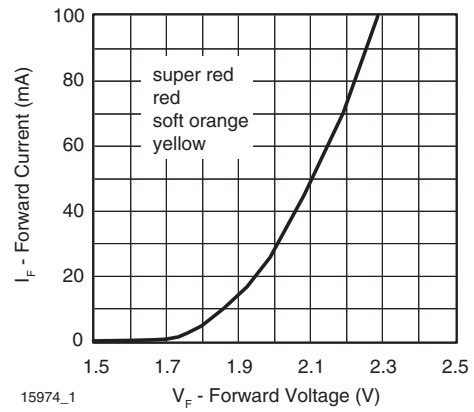

Fig. 4 - Forward Current vs. Forward Voltage

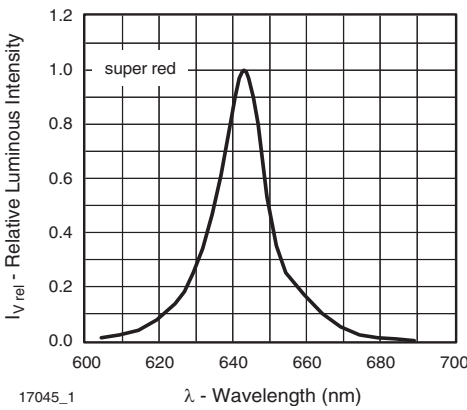

Fig. 2 - Relative Intensity vs. Wavelength

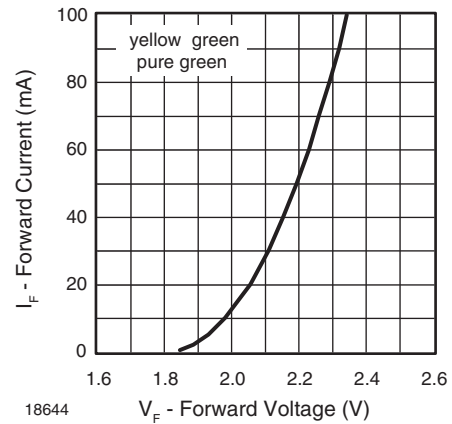

Fig. 5 - Forward Current vs. Forward Voltage

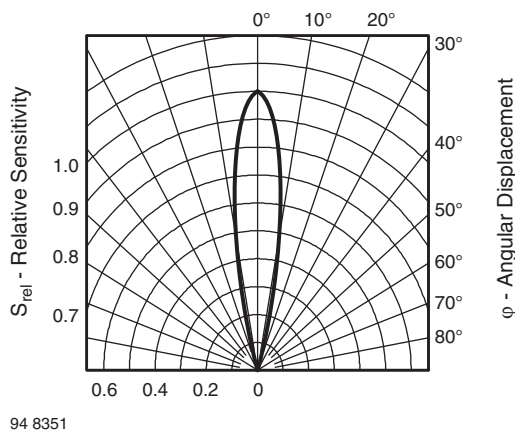

Fig. 3 - Relative Radiant Sensitivity vs. Angular Displacement

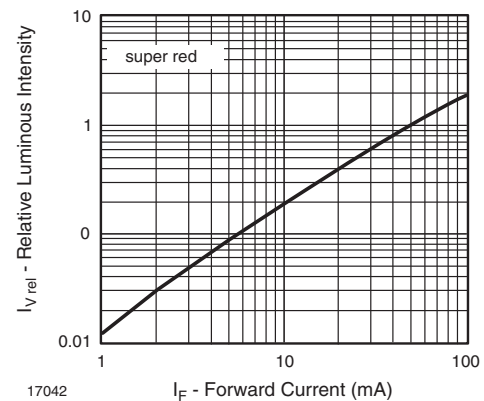

Fig. 6 - Relative Luminous Flux vs. Forward Current

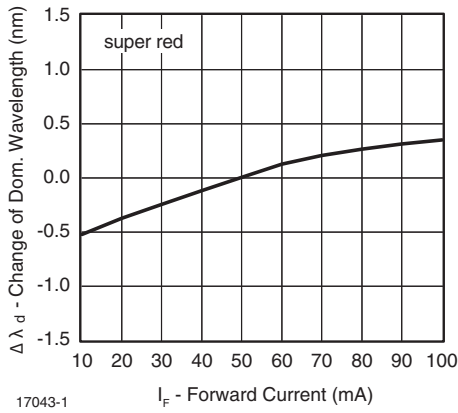

Fig. 7 - Change of Dominant Wavelength vs. Ambient Temperature

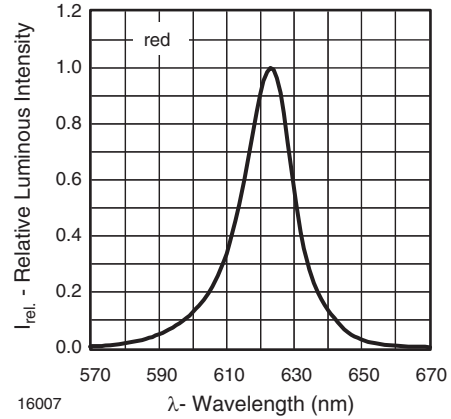

Fig. 10 - Relative Intensity vs. Wavelength



Fig. 8 - Relative Luminous Intensity vs. Ambient Temperature



Fig. 11 - Relative Luminous Flux vs. Forward Current



Fig. 9 - Change of Forward Voltage vs. Ambient Temperature



Fig. 12 - Changes of Dominant Wavelength vs. Forward Current



Fig. 13 - Relative Luminous Intensity vs. Ambient Temperature



Fig. 16 - Relative Intensity vs. Wavelength

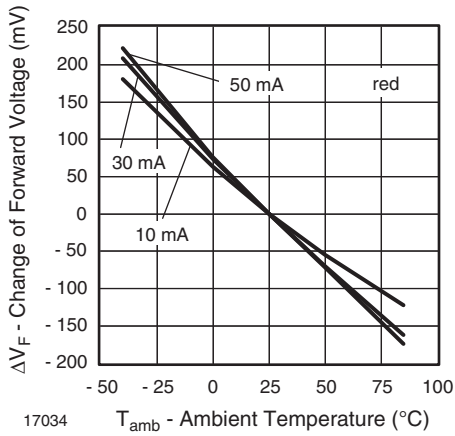

Fig. 14 - Change of Forward Voltage vs. Ambient Temperature

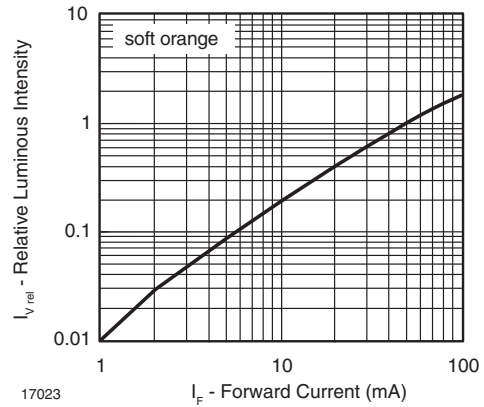

Fig. 17 - Relative Luminous Flux vs. Forward Current

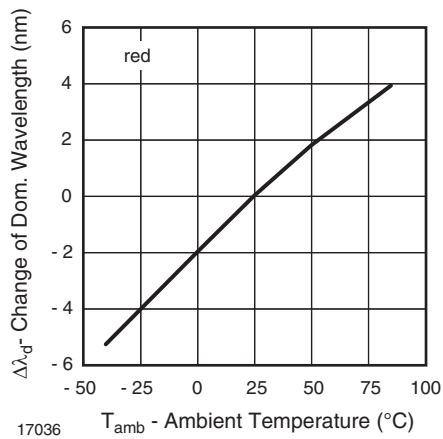

Fig. 15 - Change of Dominant Wavelength vs. Ambient Temperature

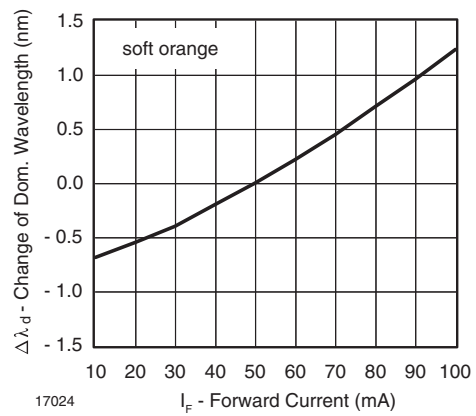

Fig. 18 - Change of Dominant Wavelength vs. Forward Current



Fig. 19 - Relative Luminous Intensity vs. Ambient Temperature



Fig. 22 - Relative Intensity vs. Wavelength



Fig. 20 - Change of Forward Voltage vs. Ambient Temperature

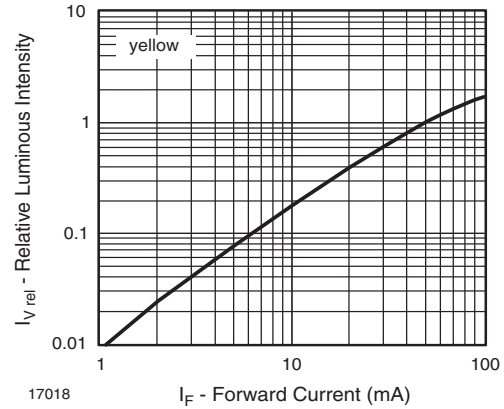

Fig. 23 - Relative Luminous Flux vs. Forward Current



Fig. 21 - Change of Dominant Wavelength vs. Ambient Temperature

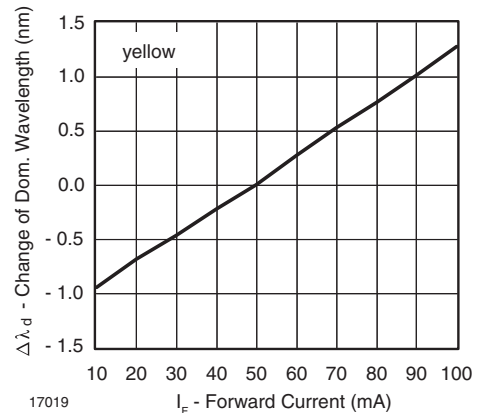

Fig. 24 - Change of Dominant Wavelength vs. Forward Current





Fig. 25 - Relative Luminous Intensity vs. Ambient Temperature



Fig. 28 - Relative Intensity vs. Wavelength

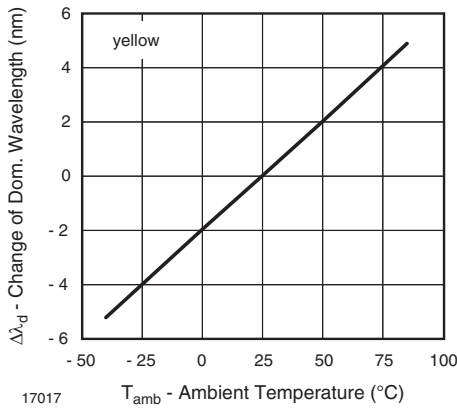

Fig. 26 - Change of Dominant Wavelength vs. Ambient Temperature



Fig. 29 - Relative Luminous Flux vs. Forward Current

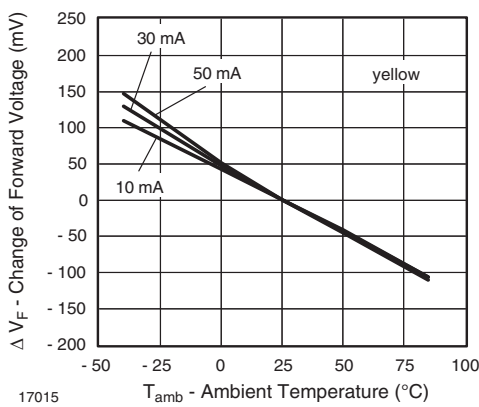

Fig. 27 - Change of Forward Voltage vs. Ambient Temperature

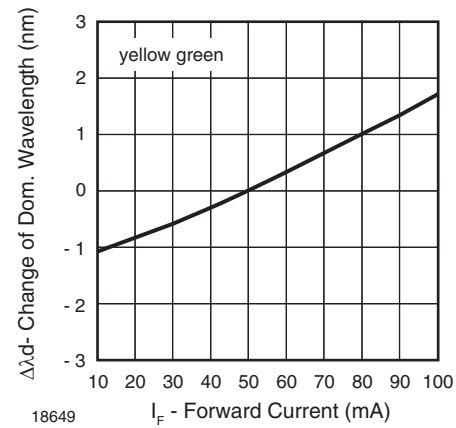

Fig. 30 - Change of Dominant Wavelength vs. Forward Current

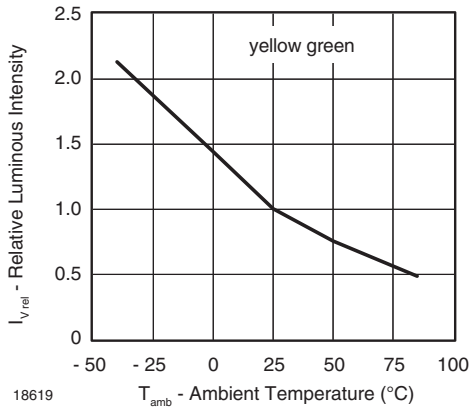

Fig. 31 - Relative Luminous Intensity vs. Ambient Temperature



Fig. 34 - Relative Intensity vs. Wavelength

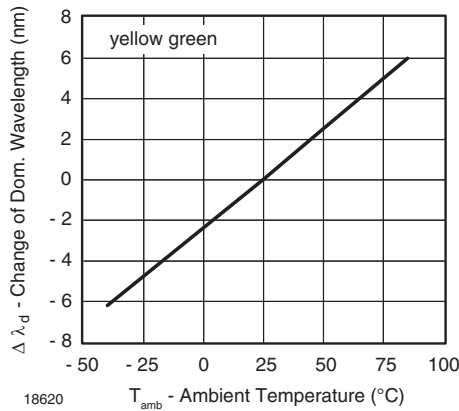

Fig. 32 - Change of Dominant Wavelength vs. Ambient Temperature

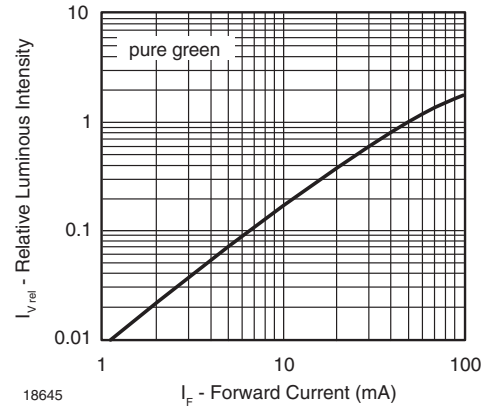

Fig. 35 - Relative Luminous Flux vs. Forward Current

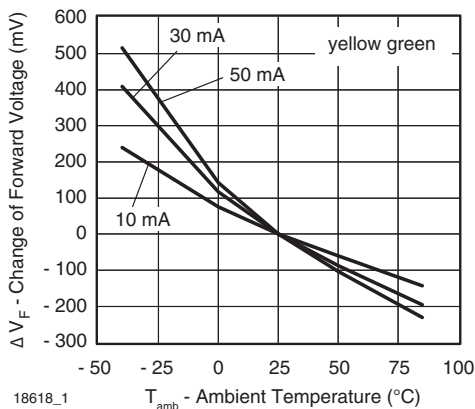

Fig. 33 - Change of Forward Voltage vs. Ambient Temperature

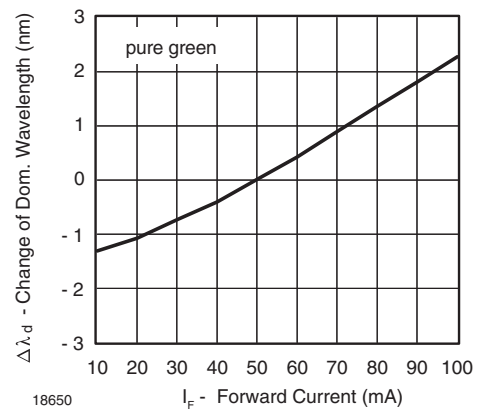

Fig. 36 - Change of Dominant Wavelength vs. Forward Current



Fig. 37 - Relative Luminous Intensity vs. Ambient Temperature



Fig. 39 - Change of Forward Voltage vs. Ambient Temperature

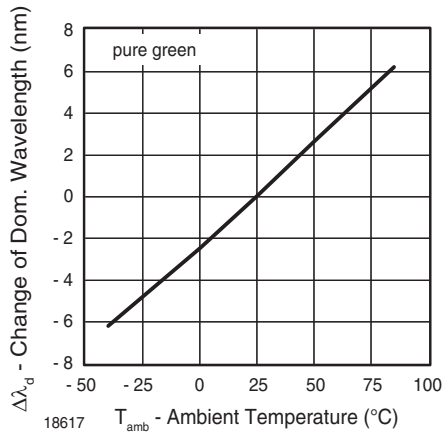
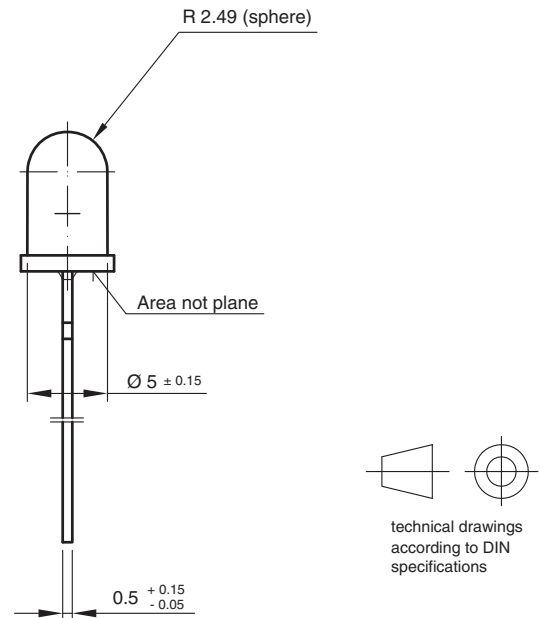
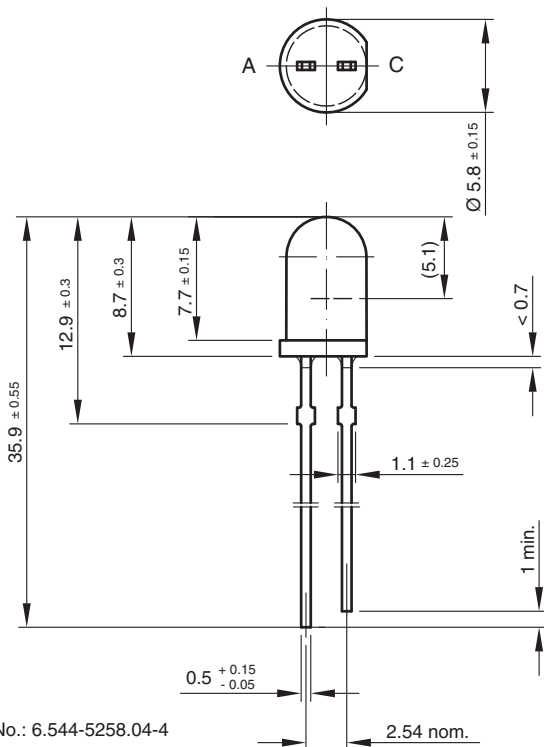

Fig. 38 - Change of Dominant Wavelength vs. Ambient Temperature



**PACKAGE DIMENSIONS** in millimeters



Drawing-No.: 6.544-5258.04-4  
Issue: 9; 23.07.10  
96 12121

**TAPE**

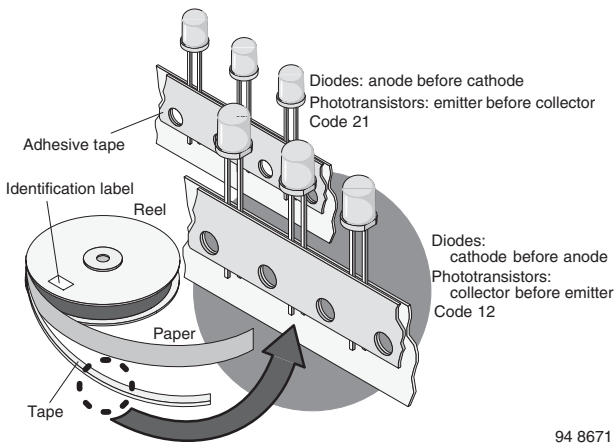

Fig. 40 - LED in Tape

94 8671

**AMMOPACK**

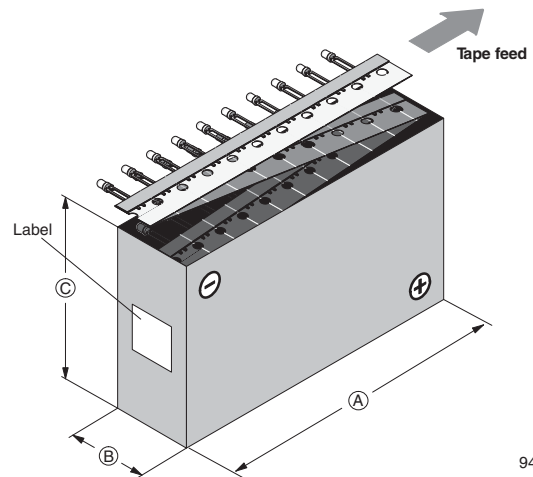

Fig. 41 - Tape Direction

94 8667-1

**Note**

- The new nomenclature for ammpack is e.g. ASZ only, without suffix for the LED orientation. The carton box has to be turned to the desired position: "+" for anode first, or "-" for cathode first. AS12Z and AS21Z are still valid for already existing types, BUT NOT FOR NEW DESIGN.



**TAPE DIMENSIONS** in millimeters



Measure limit over 20 index-holes: ± 1

|               |                         |
|---------------|-------------------------|
| Quantity per: | Reel<br>(Mat.-no. 1764) |
|               | 1000                    |

94 8172

|        |                   |
|--------|-------------------|
| Option | Dim. "H" ± 0.5 mm |
| AS     | 17.3              |



## Disclaimer

ALL PRODUCT, PRODUCT SPECIFICATIONS AND DATA ARE SUBJECT TO CHANGE WITHOUT NOTICE TO IMPROVE RELIABILITY, FUNCTION OR DESIGN OR OTHERWISE.

Vishay Intertechnology, Inc., its affiliates, agents, and employees, and all persons acting on its or their behalf (collectively, "Vishay"), disclaim any and all liability for any errors, inaccuracies or incompleteness contained in any datasheet or in any other disclosure relating to any product.

Vishay makes no warranty, representation or guarantee regarding the suitability of the products for any particular purpose or the continuing production of any product. To the maximum extent permitted by applicable law, Vishay disclaims (i) any and all liability arising out of the application or use of any product, (ii) any and all liability, including without limitation special, consequential or incidental damages, and (iii) any and all implied warranties, including warranties of fitness for particular purpose, non-infringement and merchantability.

Statements regarding the suitability of products for certain types of applications are based on Vishay's knowledge of typical requirements that are often placed on Vishay products in generic applications. Such statements are not binding statements about the suitability of products for a particular application. It is the customer's responsibility to validate that a particular product with the properties described in the product specification is suitable for use in a particular application. Parameters provided in datasheets and/or specifications may vary in different applications and performance may vary over time. All operating parameters, including typical parameters, must be validated for each customer application by the customer's technical experts. Product specifications do not expand or otherwise modify Vishay's terms and conditions of purchase, including but not limited to the warranty expressed therein.

Except as expressly indicated in writing, Vishay products are not designed for use in medical, life-saving, or life-sustaining applications or for any other application in which the failure of the Vishay product could result in personal injury or death. Customers using or selling Vishay products not expressly indicated for use in such applications do so at their own risk. Please contact authorized Vishay personnel to obtain written terms and conditions regarding products designed for such applications.

No license, express or implied, by estoppel or otherwise, to any intellectual property rights is granted by this document or by any conduct of Vishay. Product names and markings noted herein may be trademarks of their respective owners.

## Material Category Policy

**Vishay Intertechnology, Inc. hereby certifies that all its products that are identified as RoHS-Compliant fulfill the definitions and restrictions defined under Directive 2011/65/EU of The European Parliament and of the Council of June 8, 2011 on the restriction of the use of certain hazardous substances in electrical and electronic equipment (EEE) - recast, unless otherwise specified as non-compliant.**

**Please note that some Vishay documentation may still make reference to RoHS Directive 2002/95/EC. We confirm that all the products identified as being compliant to Directive 2002/95/EC conform to Directive 2011/65/EU.**

**Vishay Intertechnology, Inc. hereby certifies that all its products that are identified as Halogen-Free follow Halogen-Free requirements as per JEDEC JS709A standards. Please note that some Vishay documentation may still make reference to the IEC 61249-2-21 definition. We confirm that all the products identified as being compliant to IEC 61249-2-21 conform to JEDEC JS709A standards.**

Компания «Океан Электроники» предлагает заключение долгосрочных отношений при поставках импортных электронных компонентов на взаимовыгодных условиях!

Наши преимущества:

- Поставка оригинальных импортных электронных компонентов напрямую с производств Америки, Европы и Азии, а так же с крупнейших складов мира;
- Широкая линейка поставок активных и пассивных импортных электронных компонентов (более 30 млн. наименований);
- Поставка сложных, дефицитных, либо снятых с производства позиций;
- Оперативные сроки поставки под заказ (от 5 рабочих дней);
- Экспресс доставка в любую точку России;
- Помощь Конструкторского Отдела и консультации квалифицированных инженеров;
- Техническая поддержка проекта, помощь в подборе аналогов, поставка прототипов;
- Поставка электронных компонентов под контролем ВП;
- Система менеджмента качества сертифицирована по Международному стандарту ISO 9001;
- При необходимости вся продукция военного и аэрокосмического назначения проходит испытания и сертификацию в лаборатории (по согласованию с заказчиком);
- Поставка специализированных компонентов военного и аэрокосмического уровня качества (Xilinx, Altera, Analog Devices, Intersil, Interpoint, Microsemi, Actel, Aeroflex, Peregrine, VPT, Syfer, Eurofarad, Texas Instruments, MS Kennedy, Miteq, Cobham, E2V, MA-COM, Hittite, Mini-Circuits, General Dynamics и др.);

Компания «Океан Электроники» является официальным дистрибьютором и эксклюзивным представителем в России одного из крупнейших производителей разъемов военного и аэрокосмического назначения «JONHON», а так же официальным дистрибьютором и эксклюзивным представителем в России производителя высокотехнологичных и надежных решений для передачи СВЧ сигналов «FORSTAR».



## JONHON

«JONHON» (основан в 1970 г.)

Разъемы специального, военного и аэрокосмического назначения:

(Применяются в военной, авиационной, аэрокосмической, морской, железнодорожной, горно- и нефтедобывающей отраслях промышленности)

«FORSTAR» (основан в 1998 г.)

ВЧ соединители, коаксиальные кабели, кабельные сборки и микроволновые компоненты:

(Применяются в телекоммуникациях гражданского и специального назначения, в средствах связи, РЛС, а так же военной, авиационной и аэрокосмической отраслях промышленности).



Телефон: 8 (812) 309-75-97 (многоканальный)

Факс: 8 (812) 320-03-32

Электронная почта: [ocean@oceanchips.ru](mailto:ocean@oceanchips.ru)

Web: <http://oceanchips.ru/>

Адрес: 198099, г. Санкт-Петербург, ул. Калинина, д. 2, корп. 4, лит. А