

PULSEJACK™

1x1 Tab-DOWN RJ45



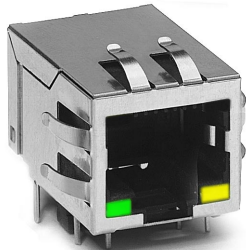

Description:

10/100 Base-TX RJ45 1x1 Tab-DOWN with LEDs 8-pin (J0 series) integrated magnetics connector (ICM), designed to support applications, such as SOHO (ADSL modems), LAN-on-Motherboard (LOM), Hub and Switches.





J0006D21BNL shown

Features and Benefits:

-  RoHS peak wave solder temperature rating 260°C
-  Suitable for CAT 5 & 6 Fast Ethernet Cable or better UTP

Electrical Performance Summary:

-  Meets or exceeds IEEE 802.3 standard for 100Base-T
-  350 µH minimum OCL with 8mA bias current
-  Minimum 1500Vrms isolation per IEEE 802.3 requirement

Electrical Specifications @ 25°C — Operating Temperature 0°C to +70°C

RoHS Compliant Part Number	Turns Ratios		Mech. Drawing	EMI Fingers	LEDs ¹ (L/R)	Insertion Loss (dB TYP)	Return Loss (dB TYP) 100W ±15W					Crosstalk (dB TYP)			Common Mode Rejection (dB TYP)		Hipot (VDC)
	TX	RX					1-65 MHz	1-10 MHz	10-30 MHz	30-60 MHz	60-80 MHz	1-30 MHz	30-60 MHz	60-100 MHz	1-50 MHz	50-150 MHz	
J0006D01BNL	1CT:1	1CT:1	A	No	G/Y	-1	-20	-16	-12	-10	-40	-35	-30	-30	-20	2250	
J0006D21NL	1CT:1	1CT:1	E	YES	N/A	-1	-20	-16	-12	-10	-40	-35	-30	-30	-20	2250	
J0006D21BNL	1CT:1	1CT:1	B	YES	G/Y	-1	-20	-16	-12	-10	-40	-35	-30	-30	-20	2250	
J0011D01NL	1CT:1	1CT:1	C	No	N/A	-1	-20	-16	-12	-10	-40	-35	-30	-30	-20	2250	
J0011D01BNL	1CT:1	1CT:1	A	No	G/Y	-1	-20	-16	-12	-10	-40	-35	-30	-30	-20	2250	
J0011D21NL	1CT:1	1CT:1	E	YES	N/A	-1	-20	-16	-12	-10	-40	-35	-30	-30	-20	2250	
J0011D21BNL	1CT:1	1CT:1	B	YES	G/Y	-1	-20	-16	-12	-10	-40	-35	-30	-30	-20	2250	
J0011D21ENL	1CT:1	1CT:1	B	YES	G/G	-1	-20	-16	-12	-10	-40	-35	-30	-30	-20	2250	
J0012D21NL	1CT:1	1CT:1	E	YES	N/A	-1	-20	-16	-12	-10	-40	-35	-30	-30	-20	2250	
J0018D21NL	1CT:1.414	1CT:1	E	YES	N/A	-1	-20	-16	-12	-10	-40	-35	-30	-30	-20	2250	
J0018D21ENL	1CT:1.414	1CT:1	B	YES	G/G	-1	-20	-16	-12	-10	-40	-35	-30	-30	-20	2250	
J0024D21NL	1CT:2	1CT:1	E	YES	N/A	-1	-20	-16	-12	-10	-40	-35	-30	-30	-20	2250	
J0024D21BNL	1CT:2	1CT:1	B	YES	G/Y	-1	-20	-16	-12	-10	-40	-35	-30	-30	-20	2250	
J0026D01NL	1CT:1	1CT:1	D	No	N/A	-1	-20	-16	-12	-10	-40	-35	-30	-30	-20	2250	
J0026D01BNL	1CT:1	1CT:1	A	No	G/Y	-1	-20	-16	-12	-10	-40	-35	-30	-30	-20	2250	
J0026D01ENL	1CT:1	1CT:1	A	No	G/G	-1	-20	-16	-12	-10	-40	-35	-30	-30	-20	2250	
J0026D01FNL ²	1CT:1	1CT:1	A	No	G/Y	-1	-20	-16	-12	-10	-40	-35	-30	-30	-20	2250	
J0026D21NL	1CT:1	1CT:1	E	YES	N/A	-1	-20	-16	-12	-10	-40	-35	-30	-30	-20	2250	
J0026D21BNL	1CT:1	1CT:1	B	YES	G/Y	-1	-20	-16	-12	-10	-40	-35	-30	-30	-20	2250	
J0026D21ENL	1CT:1	1CT:1	B	YES	G/G	-1	-20	-16	-12	-10	-40	-35	-30	-30	-20	2250	
J0026D21FNL ²	1CT:1	1CT:1	B	YES	G/Y	-1	-20	-16	-12	-10	-40	-35	-30	-30	-20	2250	
J0026D21GNL ³	1CT:1	1CT:1	B	YES	YG/G	-1	-20	-16	-12	-10	-40	-35	-30	-30	-20	2250	
J0033D21NL	1.25CT:1	1CT:1	E	YES	N/A	-1	-20	-16	-12	-10	-40	-35	-30	-30	-20	2250	
J0035D21BNL	1CT:1	1CT:1	F	YES	G/Y	-1	-20	-16	-12	-10	-40	-35	-30	-30	-20	2250	
J0073D01BNL	1CT:2.5	1CT:1	A	No	G/Y	-1	-20	-16	-12	-10	-40	-35	-30	-30	-20	2250	

Notes: 1. LEDs Left/Right: G=green, Y=yellow, N/A=none, YG=Bi-color LED Yellow Green. 2. LEDs with internal resistor. 3. Bi-color Left LED.

RJ45 Durability Testing Rating

Part Number	Mating Force (MAX)	Unmating Force (MAX)	Durability	Plug to Jack Retention (MIN)
J0 Series	5 lbs./2.268 kgs.	5 lbs./2.268 kgs.	750 Insertions	20 lbs./9.072 kgs.

RJ45 Material Specification

Part Number	Shield		Contact			Housing		MSL ³ Rating
	Material	Finish	Material	Plating Area	Solder Area ²	Material	Specification	
J0 Series	Brass	10-20m inches Nickel over 10-20m inches Brass	Phosphor Bronze	Nickel underplating and selective gold plating 15µ inches	120µ inches Sn90/Pb10 over 50µ inches nickel	Thermoplastic	UL 94 V-0	1

Notes: 1. Connector dimensions comply with FCC dimension requirements. 3. MSL = Moisture Sensitivity Level rating from 1 to 5 (highest = 1, lowest = 5)
2. RoHS parts are tin matte finish over nickel.

J0 Series Mechanicals

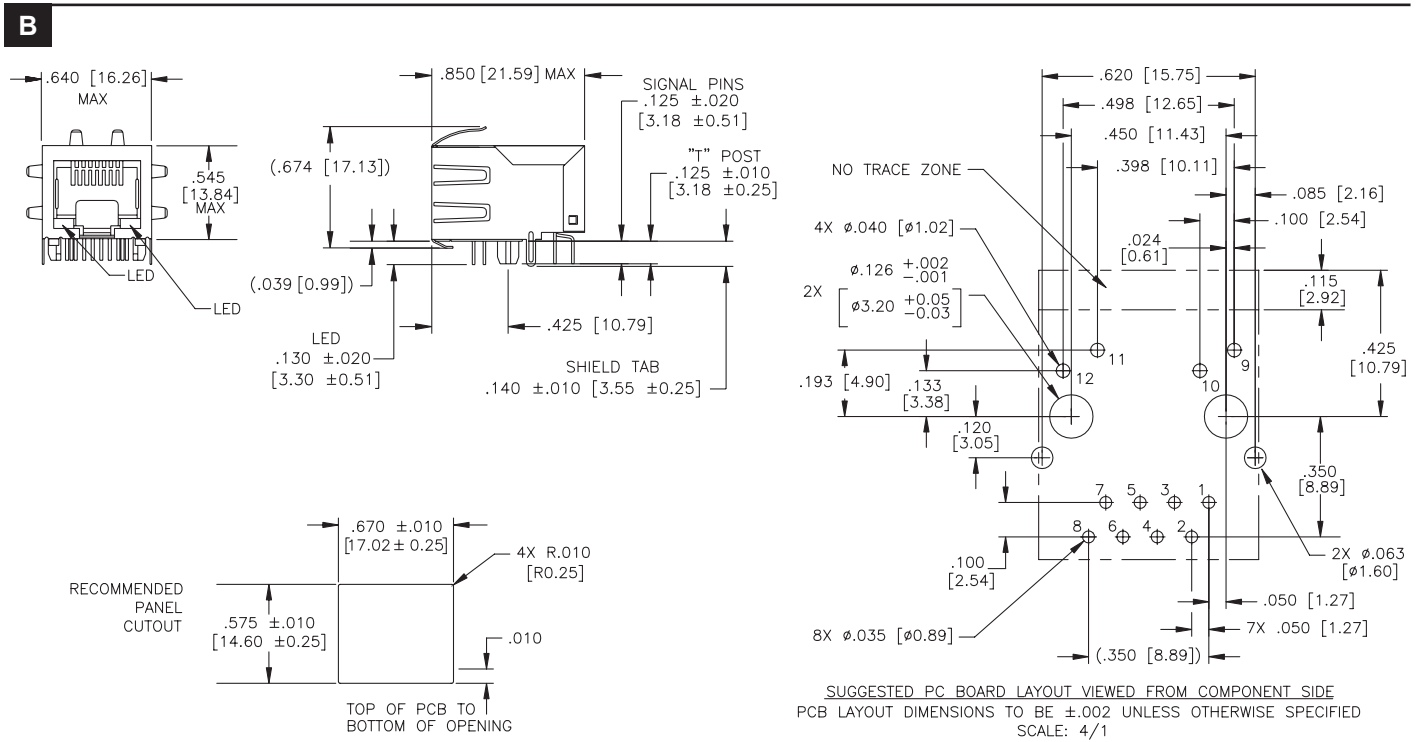
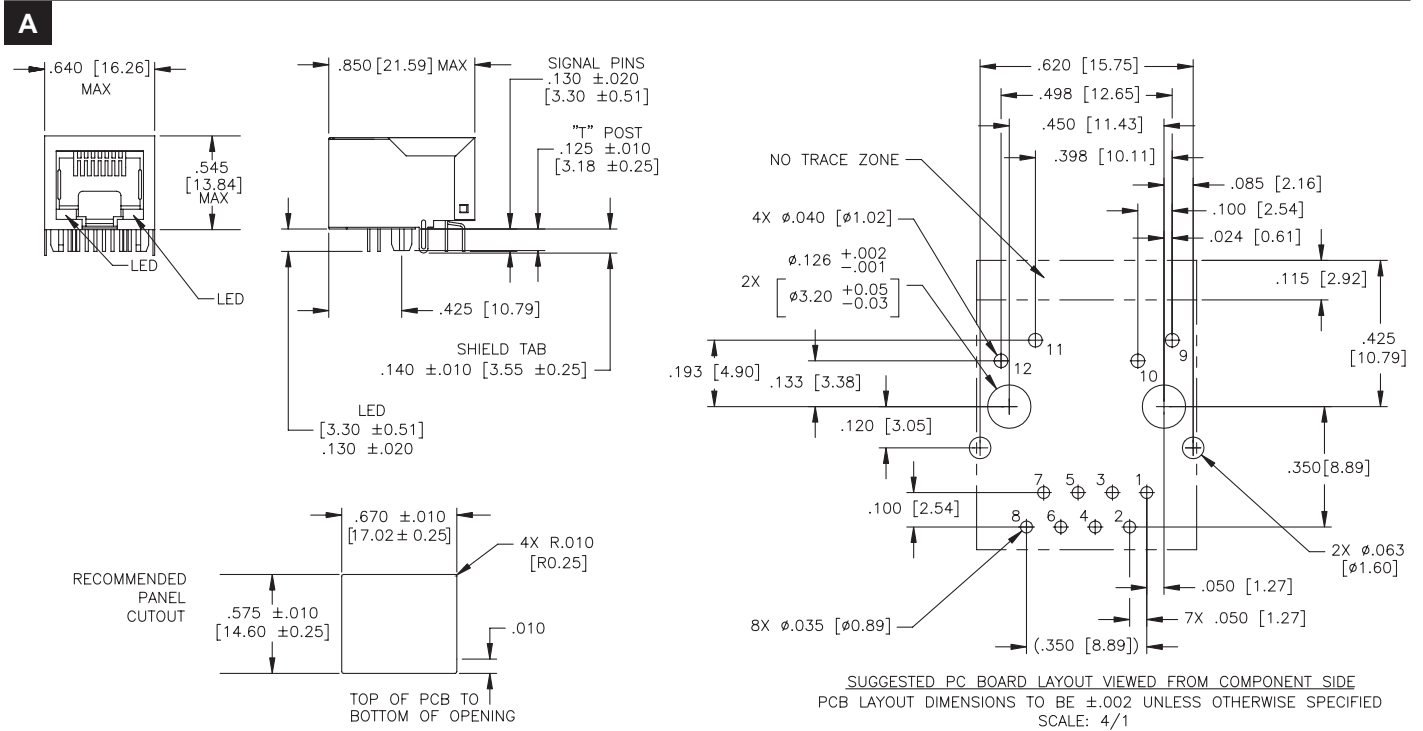

Dimensions: $\frac{\text{Inches}}{\text{mm}}$

Unless otherwise specified, all tolerances are ± $\frac{.010}{.025}$

J0 Series Mechanicals

C

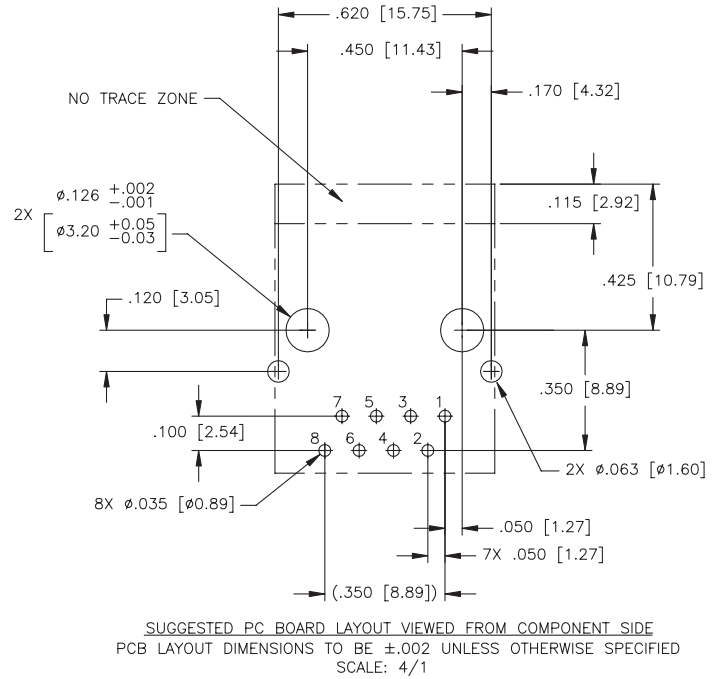

D

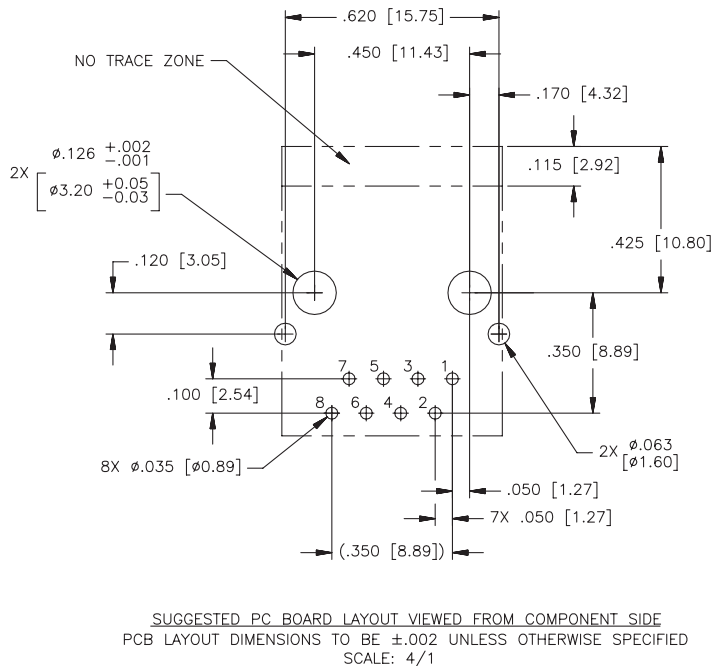
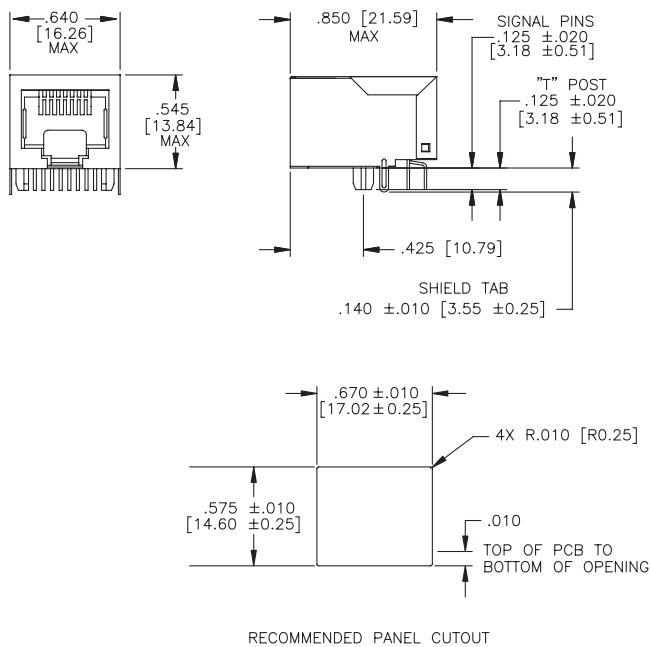

Dimensions: Inches
mm

Unless otherwise specified, all tolerances are ± .010 / 0,25

J0 Series Mechanicals

E

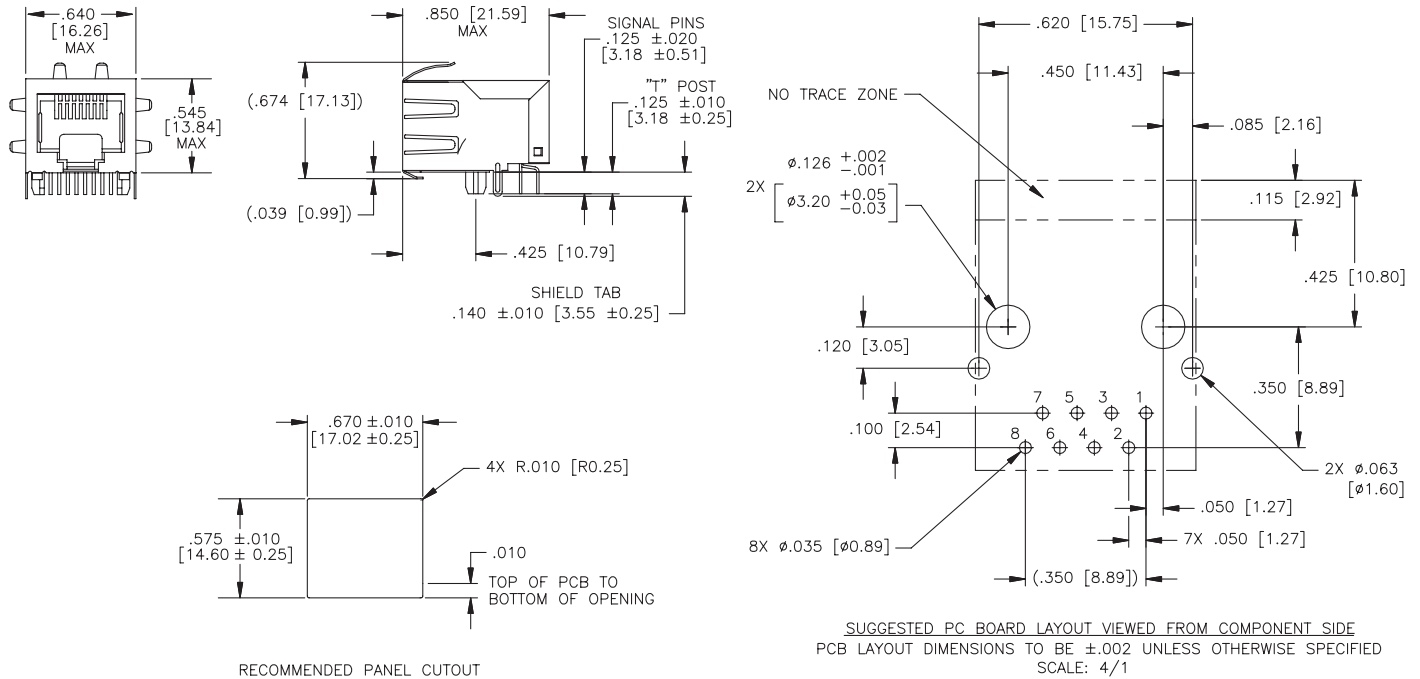

F

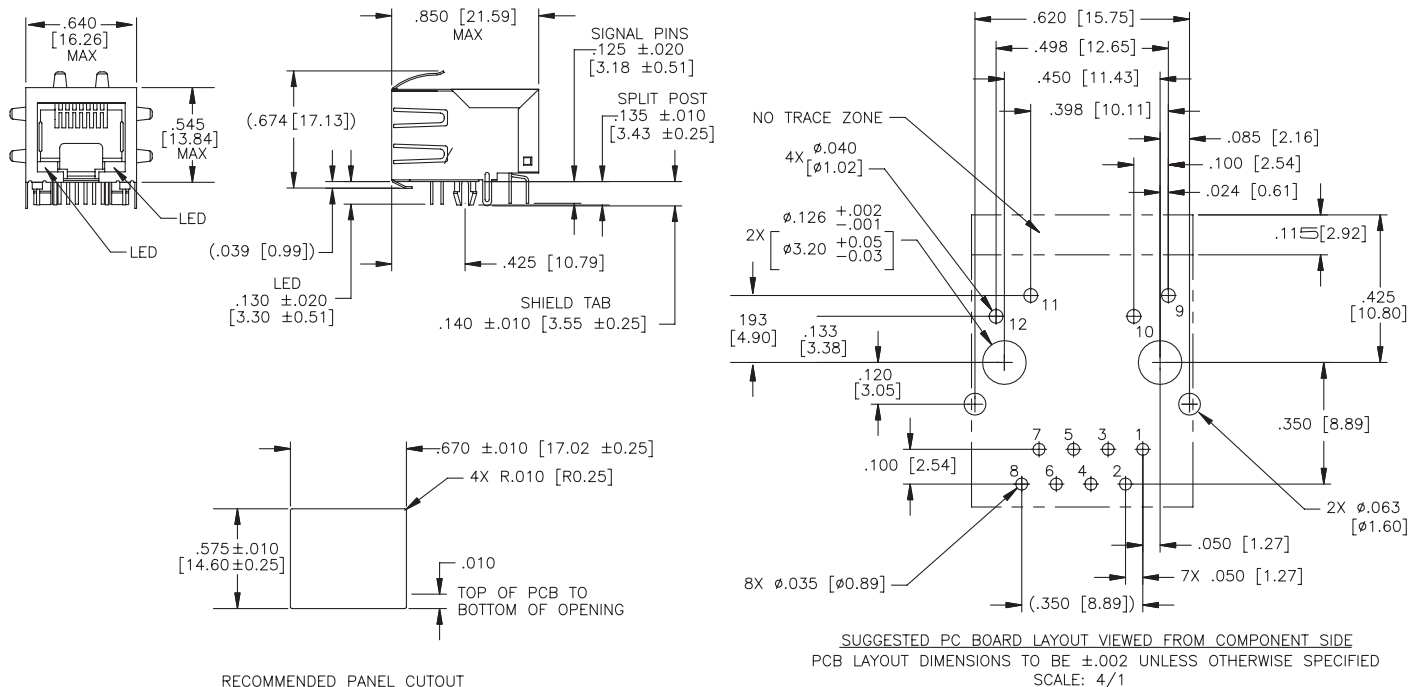

Dimensions: $\frac{\text{Inches}}{\text{mm}}$

Unless otherwise specified, all tolerances are ± .010 / 0.25



J0 Series Electrical Schematics

J0006

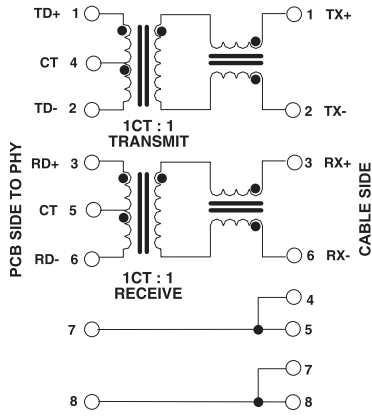

J0011

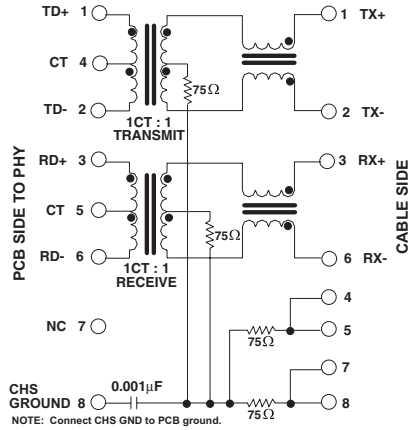

J0012

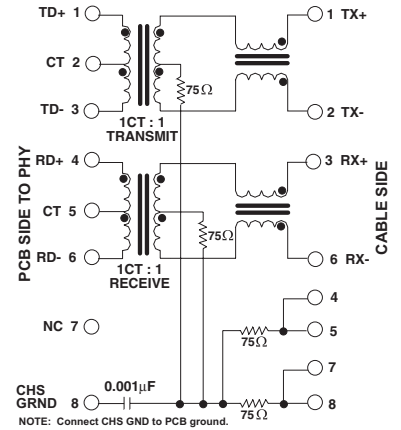

J0018

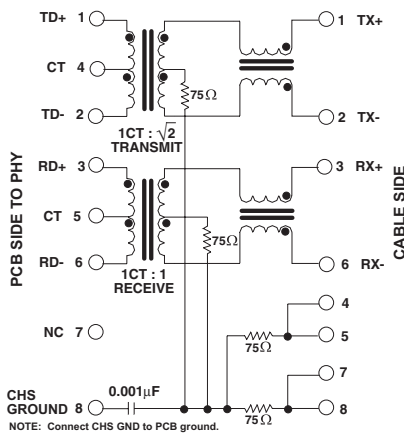

J0024

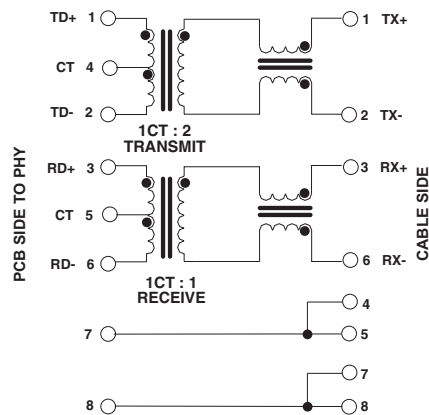

J0026

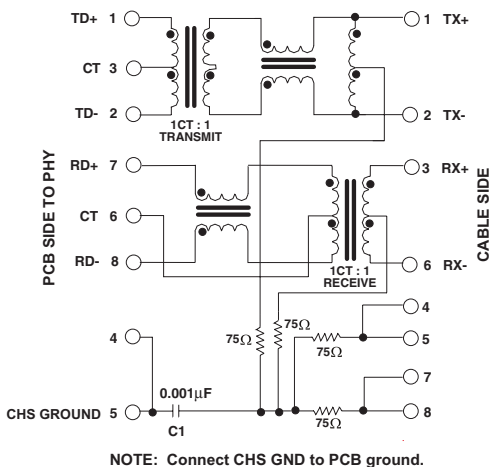

J0033

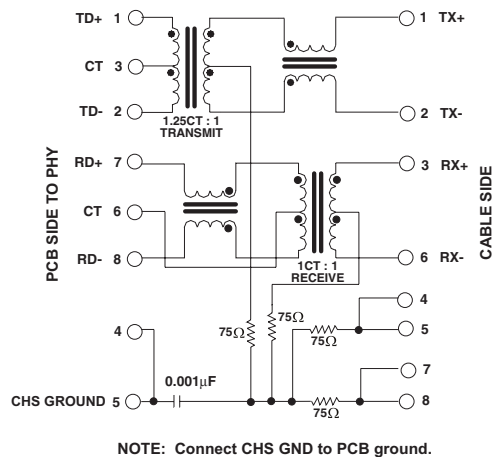

J0 Series Electrical Schematics (continued)

J0035



J0073

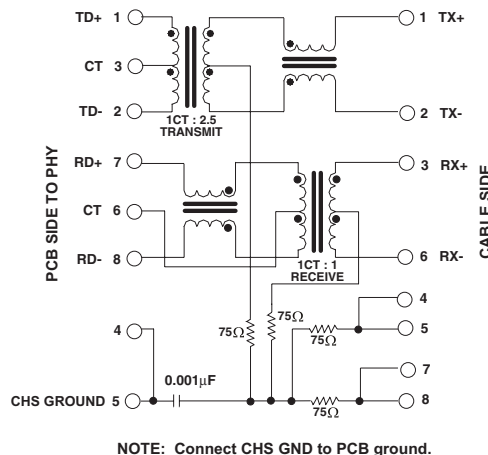

NOTE: Connect CHS GND to PCB ground.

LED Configuration

LED = "B & E" Specification (LEDs without internal resistors)

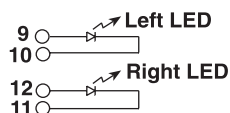

LED = "F" Specification (LEDs with internal resistors)

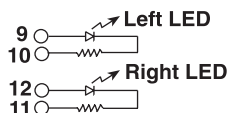

LED = "G" Specification (Bi-color LED option with internal resistors)

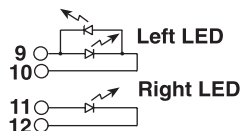

Standard LED	Wavelength	Forward* V(MAX)	(TYP)
Yellow	585 nm	2.5 V	2.1 V
Green	565 nm	2.5 V	2.2 V

* Using an internal resistor within the LED increases the voltage rating of the diode from 2.5 V to 5.0 V (assumes bias current = 20 mA).

For More Information:

Pulse Worldwide Headquarters

12220 World Trade Dr.
San Diego, CA 92128
U.S.A.

Pulse Europe

Einsteinstrasse 1
D-71083 Herrenberg
Germany

Pulse China Headquarters

B402, Shenzhen Academy of
Aerospace Technology Bldg.
10th Kejinan Rd.
High-Tech Zone
Nanshan District
Shenzhen, PR China 518057

Pulse North China

Room 2704/2705
Super Ocean Finance Ctr.
2067 Yan An Rd. West.
Shanghai 200336
China

Pulse South Asia

135 Joo Seng Rd.
#03-02
PM Industrial Bldg.
Singapore 368363

Pulse North Asia

No. 26, Kao Ching Rd.
Yang Mei Chen
Taoyuan Hsien
Taiwan
R. O. C.

www.pulseeng.com

Tel: 858 674 8100
Fax: 858 674 8262

Tel: 49 7032 7806 0
Fax: 49 7032 7806 135

TEL: 86 755 33966678
FAX: 86 755 33966700

Tel: 86 21 62787060
Fax: 86 2162786973

Tel: 65 6287 8998
Fax: 65 6280 0080

Tel: 886 3 4643715
Fax: 886 3 4641911

Performance warranty of products offered on this data sheet is limited to the parameters specified. Data is subject to change without notice. Other brand and product names mentioned herein may be trademarks or registered trademarks of their respective owners.

© Copyright, 2010. Pulse Engineering, Inc. All rights reserved.

Компания «Океан Электроники» предлагает заключение долгосрочных отношений при поставках импортных электронных компонентов на взаимовыгодных условиях!

Наши преимущества:

- Поставка оригинальных импортных электронных компонентов напрямую с производств Америки, Европы и Азии, а так же с крупнейших складов мира;
- Широкая линейка поставок активных и пассивных импортных электронных компонентов (более 30 млн. наименований);
- Поставка сложных, дефицитных, либо снятых с производства позиций;
- Оперативные сроки поставки под заказ (от 5 рабочих дней);
- Экспресс доставка в любую точку России;
- Помощь Конструкторского Отдела и консультации квалифицированных инженеров;
- Техническая поддержка проекта, помощь в подборе аналогов, поставка прототипов;
- Поставка электронных компонентов под контролем ВП;
- Система менеджмента качества сертифицирована по Международному стандарту ISO 9001;
- При необходимости вся продукция военного и аэрокосмического назначения проходит испытания и сертификацию в лаборатории (по согласованию с заказчиком);
- Поставка специализированных компонентов военного и аэрокосмического уровня качества (Xilinx, Altera, Analog Devices, Intersil, Interpoint, Microsemi, Actel, Aeroflex, Peregrine, VPT, Syfer, Eurofarad, Texas Instruments, MS Kennedy, Miteq, Cobham, E2V, MA-COM, Hittite, Mini-Circuits, General Dynamics и др.);

Компания «Океан Электроники» является официальным дистрибьютором и эксклюзивным представителем в России одного из крупнейших производителей разъемов военного и аэрокосмического назначения «JONHON», а так же официальным дистрибьютором и эксклюзивным представителем в России производителя высокотехнологичных и надежных решений для передачи СВЧ сигналов «FORSTAR».



JONHON

«JONHON» (основан в 1970 г.)

Разъемы специального, военного и аэрокосмического назначения:

(Применяются в военной, авиационной, аэрокосмической, морской, железнодорожной, горно- и нефтедобывающей отраслях промышленности)

«FORSTAR» (основан в 1998 г.)

ВЧ соединители, коаксиальные кабели,
кабельные сборки и микроволновые компоненты:

(Применяются в телекоммуникациях гражданского и специального назначения, в средствах связи, РЛС, а так же военной, авиационной и аэрокосмической отраслях промышленности).



Телефон: 8 (812) 309-75-97 (многоканальный)

Факс: 8 (812) 320-03-32

Электронная почта: ocean@oceanchips.ru

Web: <http://oceanchips.ru/>

Адрес: 198099, г. Санкт-Петербург, ул. Калинина, д. 2, корп. 4, лит. А