

40V DUAL P-CHANNEL ENHANCEMENT MODE MOSFET

Product Summary

$V_{(BR)DSS}$	$R_{DS(on) \max}$	$I_D \max (A)$ $T_A = 25^\circ C$ (Notes 6 & 8)
-40V	25mΩ @ $V_{GS} = -10V$	-7.6
	45mΩ @ $V_{GS} = -4.5V$	-6.0

Description and Applications

This MOSFET has been designed to minimize the on-state resistance and yet maintain superior switching performance, making it ideal for high efficiency power management applications.

- Motor control
- Backlighting
- DC-DC Converters
- Printer equipment

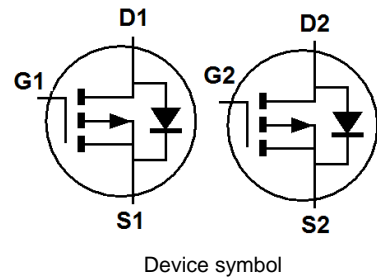
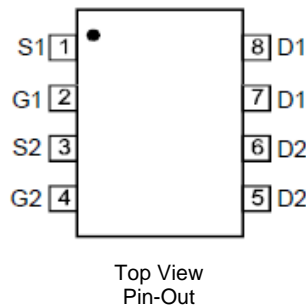
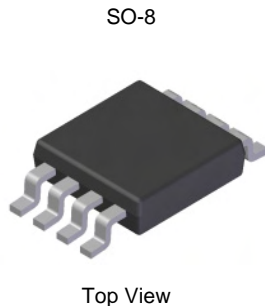

Features and Benefits

- Low $R_{DS(on)}$ – Minimizes conduction losses
- Fast switching speed – Minimizes switching losses
- **Totally Lead-Free & Fully RoHS compliant (Notes 1 & 2)**
- **Halogen and Antimony Free. "Green" Device (Note 3)**
- **Qualified to AEC-Q101 Standards for High Reliability**

Mechanical Data

- Case: SO-8
- Case Material: Molded Plastic, "Green" Molding Compound. UL Flammability Classification Rating 94V-0 (Note 1)
- Moisture Sensitivity: Level 1 per J-STD-020
- Terminals: Finish - Matte Tin annealed over Copper lead frame. Solderable per MIL-STD-202, Method 208 (E3)
- Weight: 0.074 grams (approximate)

Ordering Information (Note 4)

Product	Marking	Reel size (inches)	Tape width (mm)	Quantity per reel
DMP4025LSD-13	P4025LD	13	12	2,500

- Notes:
1. No purposely added lead. Fully EU Directive 2002/95/EC (RoHS) & 2011/65/EU (RoHS 2) compliant.
 2. See <http://www.diodes.com> for more information about Diodes Incorporated's definitions of Halogen and Antimony free, "Green" and Lead-Free.
 3. Halogen and Antimony free "Green" products are defined as those which contain <900ppm bromine, <900ppm chlorine (<1500ppm total Br + Cl) and <1000ppm antimony compounds.
 4. For packaging details, go to our website at <http://www.diodes.com>

Marking Information

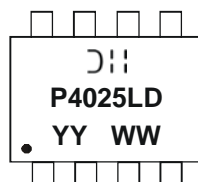

 = Manufacturer's Marking
 P4025LD = Product Type Marking Code
 YYWW = Date Code Marking
 YY = Year (ex: 10 = 2010)
 WW = Week (01 - 53)

Maximum Ratings @ $T_A = 25^\circ\text{C}$ unless otherwise specified

Characteristic		Symbol	Value	Units	
Drain-Source Voltage		V_{DSS}	-40	V	
Gate-Source Voltage		V_{GSS}	± 20		
Continuous Drain Current	$V_{GS} = -10\text{V}$	(Notes 6 & 8)	-7.6	A	
		$T_A = 70^\circ\text{C}$ (Notes 6 & 8)	-6.1		
		(Notes 5 & 8)	-5.8		
		(Notes 5 & 9)	-6.9		
Pulsed Drain Current	$V_{GS} = -10\text{V}$	(Notes 7 & 8)	I_{DM}		-28.0
Continuous Source Current (Body diode)		(Notes 6 & 8)	I_S		-3.0
Pulsed Source Current (Body diode)		(Notes 7 & 8)	I_{SM}	-28.0	

Thermal Characteristics @ $T_A = 25^\circ\text{C}$ unless otherwise specified

Characteristic		Symbol	Value	Unit
Power Dissipation Linear Derating Factor	(Notes 5 & 8)	P_D	1.25	W mW/ $^\circ\text{C}$
			10	
	(Notes 5 & 9)		1.8	
	(Notes 6 & 8)		14.3	
Thermal Resistance, Junction to Ambient	(Notes 5 & 8)	$R_{\theta JA}$	2.14	$^\circ\text{C/W}$
	(Notes 5 & 9)		17.2	
	(Notes 6 & 8)		100	
Thermal Resistance, Junction to Lead	(Notes 5 & 9)	$R_{\theta JL}$	70	
	(Notes 6 & 8)		58	
Operating and Storage Temperature Range		T_J, T_{STG}	-55 to +150	

- Notes:
5. For a device surface mounted on 25mm x 25mm x 1.6mm FR4 PCB with high coverage of single sided 1oz copper, in still air conditions; the device is measured when operating in a steady-state condition.
 6. Same as note (2), except the device is measured at $t \leq 10$ sec.
 7. Same as note (2), except the device is pulsed with $D = 0.02$ and pulse width 300 μs .
 8. For a dual device with one active die.
 9. For a device with two active die running at equal power.
 10. Thermal resistance from junction to solder-point (at the end of the drain lead).

Thermal Characteristics

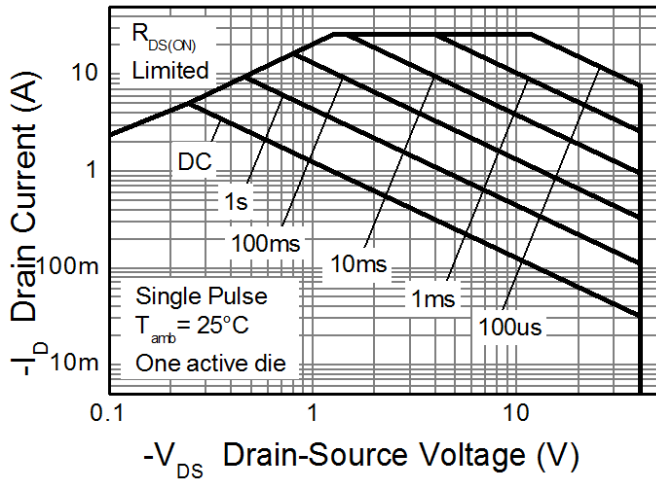

P-channel Safe Operating Area

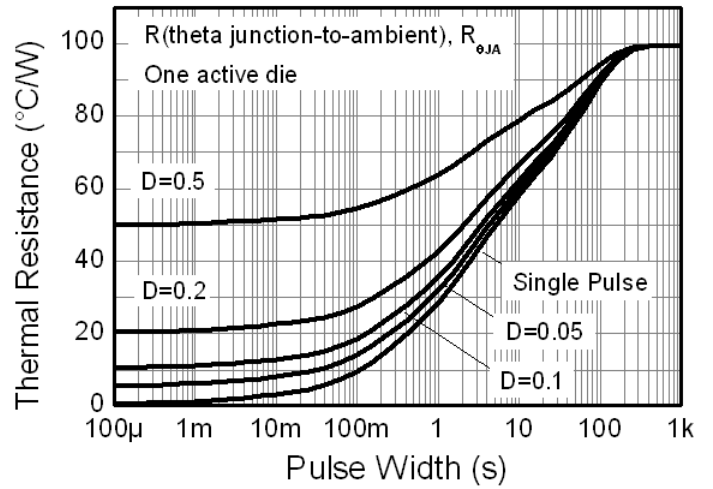

Transient Thermal Impedance

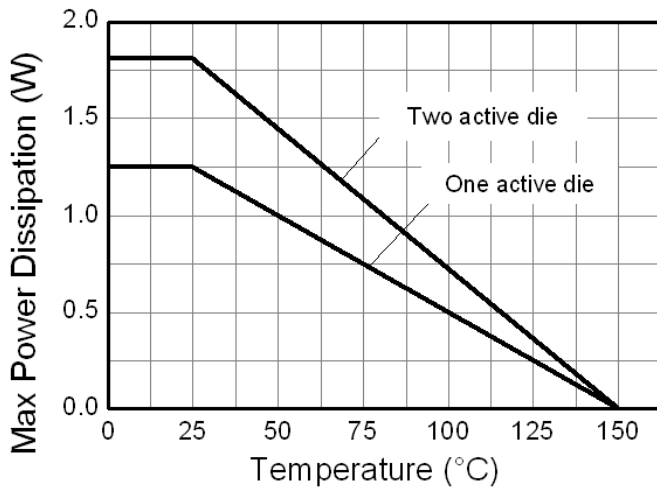

Derating Curve

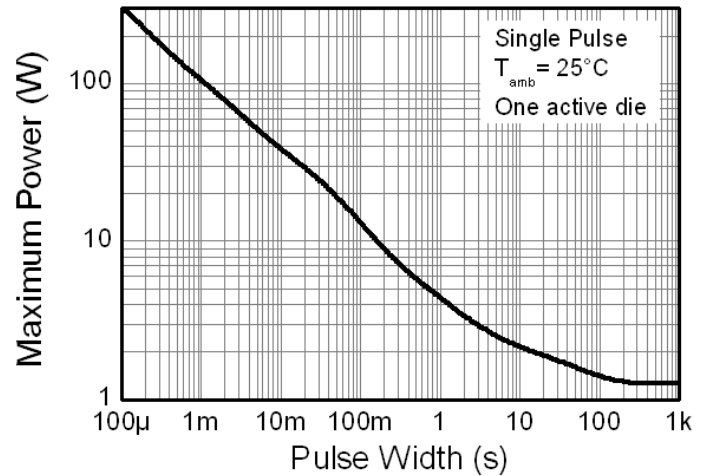

Pulse Power Dissipation

Electrical Characteristics $T_A = 25^\circ\text{C}$ unless otherwise specified

Characteristic	Symbol	Min	Typ	Max	Unit	Test Condition
OFF CHARACTERISTICS						
Drain-Source Breakdown Voltage	BV_{DSS}	-40	—	—	V	$I_D = -250\mu\text{A}$, $V_{GS} = 0\text{V}$
Zero Gate Voltage Drain Current	I_{DSS}	—	—	-1.0	μA	$V_{DS} = -40\text{V}$, $V_{GS} = 0\text{V}$
Gate-Source Leakage	I_{GSS}	—	—	± 100	nA	$V_{GS} = \pm 20\text{V}$, $V_{DS} = 0\text{V}$
ON CHARACTERISTICS						
Gate Threshold Voltage	$V_{GS(th)}$	-0.8	-1.3	-1.8	V	$I_D = -250\mu\text{A}$, $V_{DS} = V_{GS}$
Static Drain-Source On-Resistance (Note 11)	$R_{DS(on)}$	—	18	25	m Ω	$V_{GS} = -10\text{V}$, $I_D = -3\text{A}$
			30	45		$V_{GS} = -4.5\text{V}$, $I_D = -3\text{A}$
Forward Transconductance (Notes 11 & 12)	g_{fs}	—	16.6	—	S	$V_{DS} = -5\text{V}$, $I_D = -3\text{A}$
Diode Forward Voltage (Note 11)	V_{SD}	—	-0.7	-1.0	V	$I_S = -1\text{A}$, $V_{GS} = 0\text{V}$
DYNAMIC CHARACTERISTICS (Note 12)						
Input Capacitance	C_{iss}	—	1640	—	pF	$V_{DS} = -20\text{V}$, $V_{GS} = 0\text{V}$ $f = 1\text{MHz}$
Output Capacitance	C_{oss}	—	179	—		
Reverse Transfer Capacitance	C_{rss}	—	128	—		
Gate Resistance	R_g	—	6.43	—	Ω	$V_{DS} = 0\text{V}$, $V_{GS} = 0\text{V}$, $f = 1\text{MHz}$
Total Gate Charge (Note 10)	Q_g	—	14.0	—	nC	$V_{GS} = -4.5\text{V}$ $V_{GS} = -10\text{V}$ $V_{DS} = -20\text{V}$ $I_D = -3\text{A}$
Total Gate Charge (Note 10)	Q_g	—	33.7	—		
Gate-Source Charge (Note 10)	Q_{gs}	—	5.5	—		
Gate-Drain Charge (Note 10)	Q_{gd}	—	7.3	—		
Turn-On Delay Time (Note 10)	$t_{D(on)}$	—	6.9	—	ns	$V_{DD} = -20\text{V}$, $V_{GS} = -10\text{V}$ $I_D = -3\text{A}$
Turn-On Rise Time (Note 10)	t_r	—	14.7	—		
Turn-Off Delay Time (Note 10)	$t_{D(off)}$	—	53.7	—		
Turn-Off Fall Time (Note 10)	t_f	—	30.9	—		

Notes: 11. Measured under pulsed conditions. Pulse width $\leq 300\mu\text{s}$; duty cycle $\leq 2\%$
 12. For design aid only, not subject to production testing.
 13. Switching characteristics are independent of operating junction temperatures.

Typical Characteristics

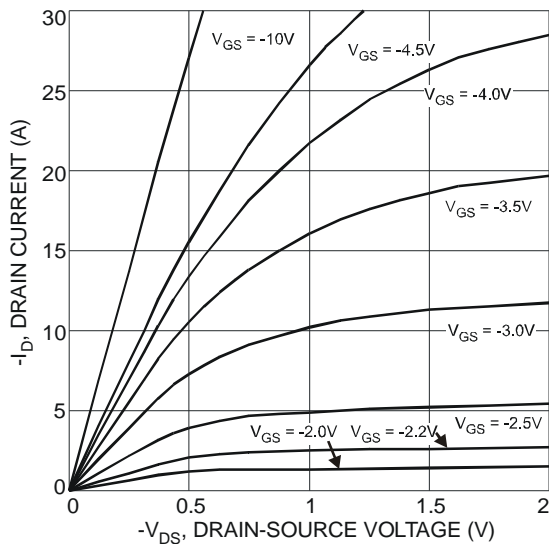

Fig. 1 Typical Output Characteristic

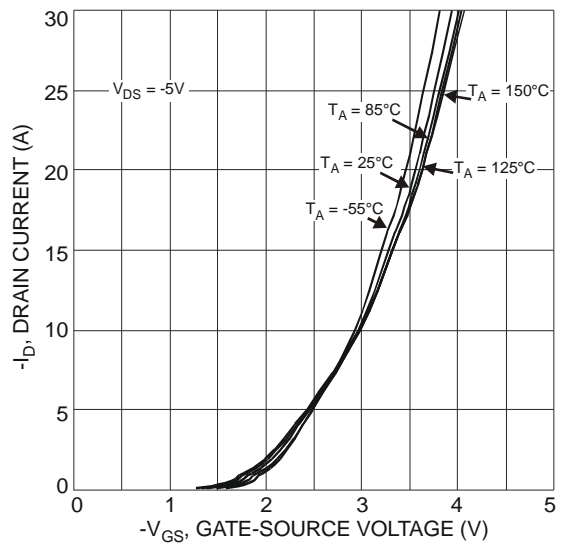

Fig. 2 Typical Transfer Characteristic

DMP4025LSD

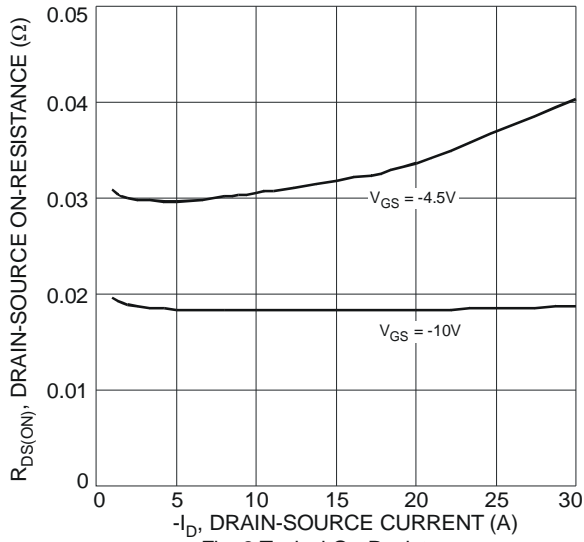

Fig. 3 Typical On-Resistance vs. Drain Current and Gate Voltage

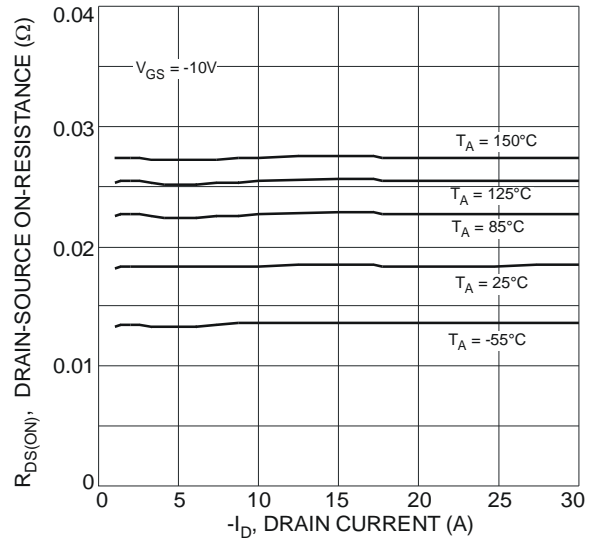

Fig. 4 Typical On-Resistance vs. Drain Current and Temperature

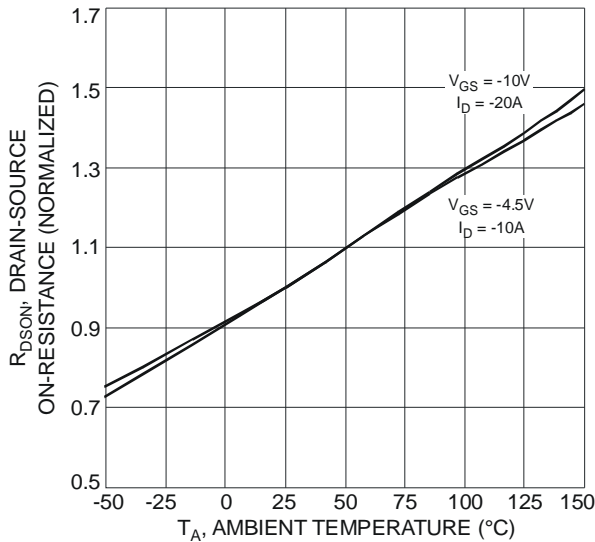

Fig. 5 On-Resistance Variation with Temperature

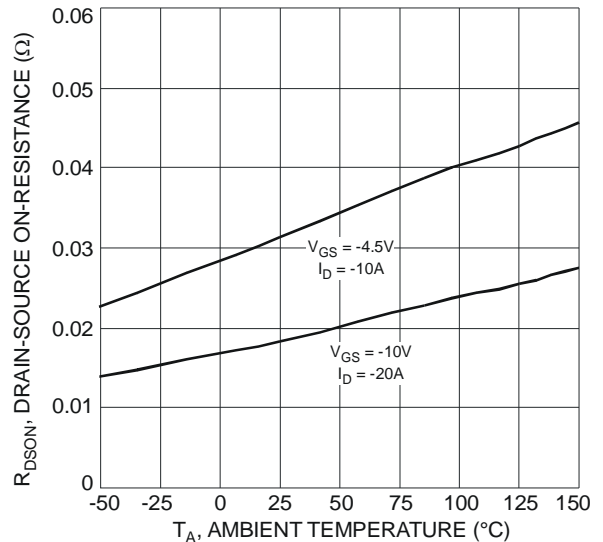

Fig. 6 On-Resistance Variation with Temperature

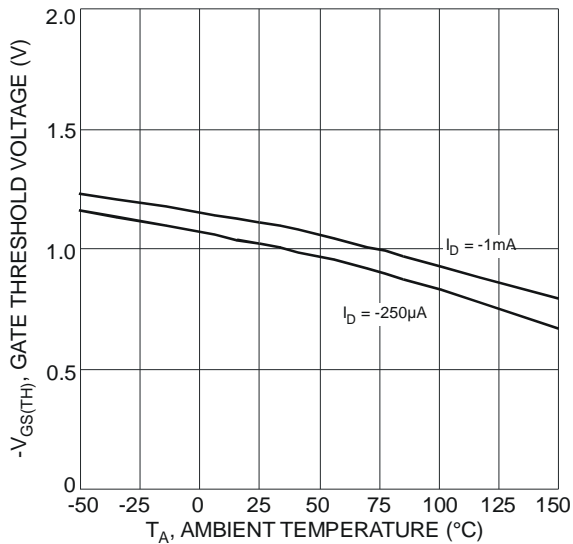

Fig. 7 Gate Threshold Variation vs. Ambient Temperature

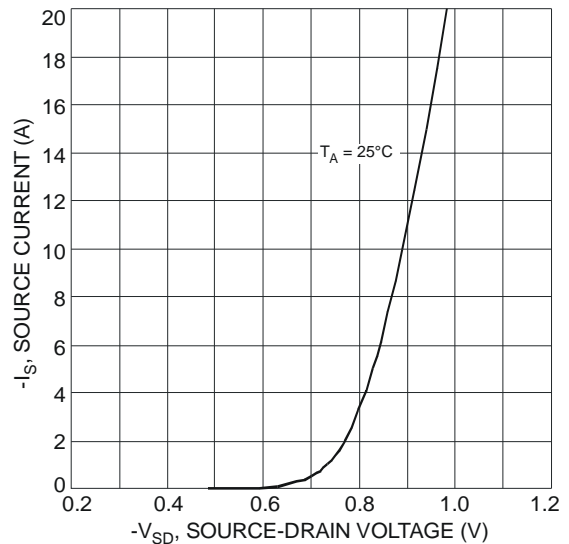
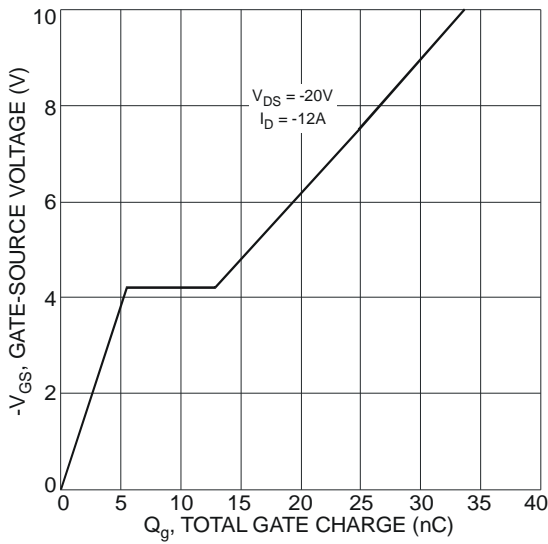
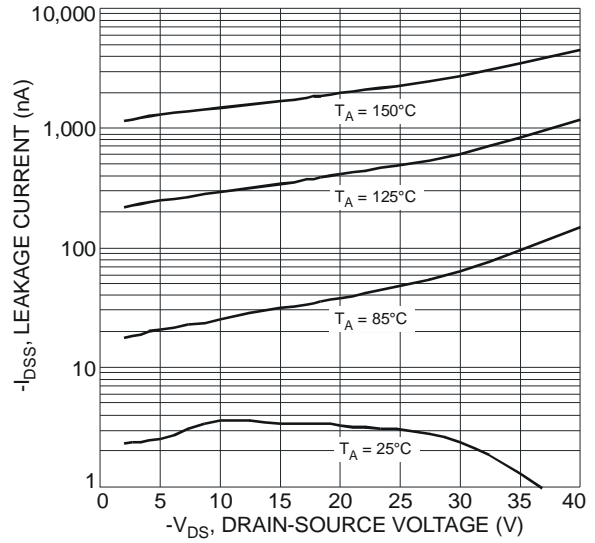
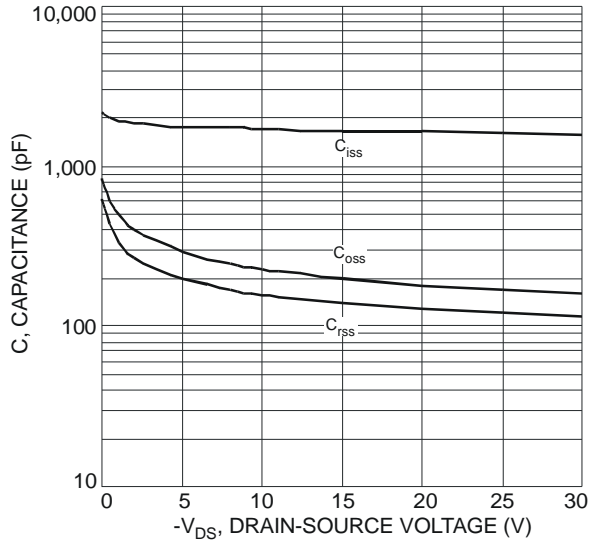

Fig. 8 Diode Forward Voltage vs. Current

DMP4025LSD



DMP4025LSD

Package Outline Dimensions

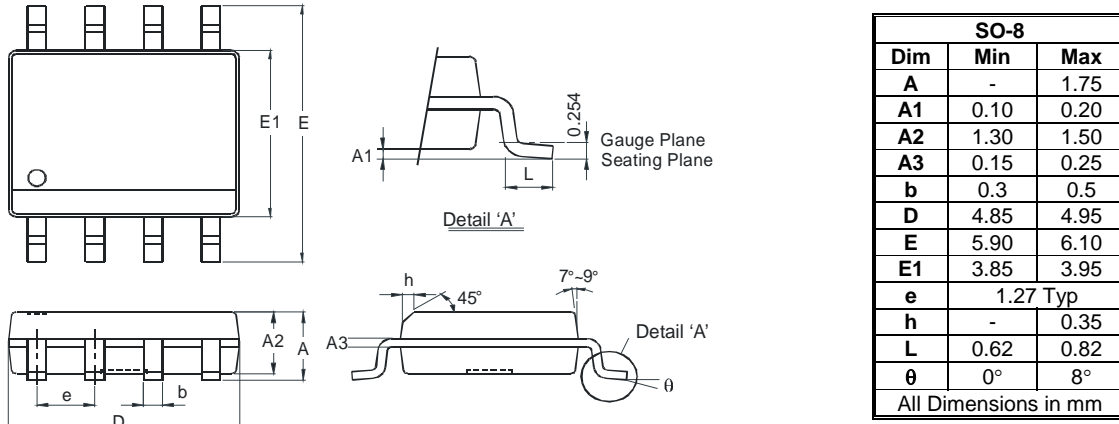

Suggested Pad Layout

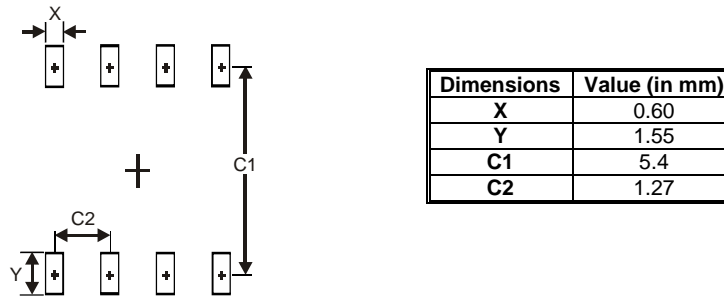

IMPORTANT NOTICE

DIODES INCORPORATED MAKES NO WARRANTY OF ANY KIND, EXPRESS OR IMPLIED, WITH REGARDS TO THIS DOCUMENT, INCLUDING, BUT NOT LIMITED TO, THE IMPLIED WARRANTIES OF MERCHANTABILITY AND FITNESS FOR A PARTICULAR PURPOSE (AND THEIR EQUIVALENTS UNDER THE LAWS OF ANY JURISDICTION).

Diodes Incorporated and its subsidiaries reserve the right to make modifications, enhancements, improvements, corrections or other changes without further notice to this document and any product described herein. Diodes Incorporated does not assume any liability arising out of the application or use of this document or any product described herein; neither does Diodes Incorporated convey any license under its patent or trademark rights, nor the rights of others. Any Customer or user of this document or products described herein in such applications shall assume all risks of such use and will agree to hold Diodes Incorporated and all the companies whose products are represented on Diodes Incorporated website, harmless against all damages.

Diodes Incorporated does not warrant or accept any liability whatsoever in respect of any products purchased through unauthorized sales channel. Should Customers purchase or use Diodes Incorporated products for any unintended or unauthorized application, Customers shall indemnify and hold Diodes Incorporated and its representatives harmless against all claims, damages, expenses, and attorney fees arising out of, directly or indirectly, any claim of personal injury or death associated with such unintended or unauthorized application.

Products described herein may be covered by one or more United States, international or foreign patents pending. Product names and markings noted herein may also be covered by one or more United States, international or foreign trademarks.

LIFE SUPPORT

Diodes Incorporated products are specifically not authorized for use as critical components in life support devices or systems without the express written approval of the Chief Executive Officer of Diodes Incorporated. As used herein:

- A. Life support devices or systems are devices or systems which:
 - 1. are intended to implant into the body, or
 - 2. support or sustain life and whose failure to perform when properly used in accordance with instructions for use provided in the labeling can be reasonably expected to result in significant injury to the user.
- B. A critical component is any component in a life support device or system whose failure to perform can be reasonably expected to cause the failure of the life support device or to affect its safety or effectiveness.

Customers represent that they have all necessary expertise in the safety and regulatory ramifications of their life support devices or systems, and acknowledge and agree that they are solely responsible for all legal, regulatory and safety-related requirements concerning their products and any use of Diodes Incorporated products in such safety-critical, life support devices or systems, notwithstanding any devices- or systems-related information or support that may be provided by Diodes Incorporated. Further, Customers must fully indemnify Diodes Incorporated and its representatives against any damages arising out of the use of Diodes Incorporated products in such safety-critical, life support devices or systems.

Copyright © 2012, Diodes Incorporated

www.diodes.com

Компания «Океан Электроники» предлагает заключение долгосрочных отношений при поставках импортных электронных компонентов на взаимовыгодных условиях!

Наши преимущества:

- Поставка оригинальных импортных электронных компонентов напрямую с производств Америки, Европы и Азии, а так же с крупнейших складов мира;
- Широкая линейка поставок активных и пассивных импортных электронных компонентов (более 30 млн. наименований);
- Поставка сложных, дефицитных, либо снятых с производства позиций;
- Оперативные сроки поставки под заказ (от 5 рабочих дней);
- Экспресс доставка в любую точку России;
- Помощь Конструкторского Отдела и консультации квалифицированных инженеров;
- Техническая поддержка проекта, помощь в подборе аналогов, поставка прототипов;
- Поставка электронных компонентов под контролем ВП;
- Система менеджмента качества сертифицирована по Международному стандарту ISO 9001;
- При необходимости вся продукция военного и аэрокосмического назначения проходит испытания и сертификацию в лаборатории (по согласованию с заказчиком);
- Поставка специализированных компонентов военного и аэрокосмического уровня качества (Xilinx, Altera, Analog Devices, Intersil, Interpoint, Microsemi, Actel, Aeroflex, Peregrine, VPT, Syfer, Eurofarad, Texas Instruments, MS Kennedy, Miteq, Cobham, E2V, MA-COM, Hittite, Mini-Circuits, General Dynamics и др.);

Компания «Океан Электроники» является официальным дистрибьютором и эксклюзивным представителем в России одного из крупнейших производителей разъемов военного и аэрокосмического назначения «JONHON», а так же официальным дистрибьютором и эксклюзивным представителем в России производителя высокотехнологичных и надежных решений для передачи СВЧ сигналов «FORSTAR».



JONHON

«JONHON» (основан в 1970 г.)

Разъемы специального, военного и аэрокосмического назначения:

(Применяются в военной, авиационной, аэрокосмической, морской, железнодорожной, горно- и нефтедобывающей отраслях промышленности)

«FORSTAR» (основан в 1998 г.)

ВЧ соединители, коаксиальные кабели, кабельные сборки и микроволновые компоненты:

(Применяются в телекоммуникациях гражданского и специального назначения, в средствах связи, РЛС, а так же военной, авиационной и аэрокосмической отраслях промышленности).



Телефон: 8 (812) 309-75-97 (многоканальный)

Факс: 8 (812) 320-03-32

Электронная почта: ocean@oceanchips.ru

Web: <http://oceanchips.ru/>

Адрес: 198099, г. Санкт-Петербург, ул. Калинина, д. 2, корп. 4, лит. А