

# MAX44284

# 36V, Input Common-Mode, High-Precision, Low-Power Current-Sense Amplifier

## General Description

The MAX44284 is a high-side, current-sense amplifier that operates with a 1.7V to 5.5V single supply and is optimized for very low power operation with only 21µA of quiescent current.

The MAX44284 offers precision accuracy specifications of 2µV  $V_{OS}$  and gain error of 0.05%. The device features an input common-mode voltage range from -0.1V to +36V. This current-sense amplifier has a voltage output and is offered in four different gain versions.

The MAX44284 is offered in small 6-bump, 0.4mm-pitch WLP (1.3mm x 0.9mm) and 6-pin SOT23 packages and is specified for operation over the -40°C to +125°C automotive temperature range.

## Applications

- Smartphones and Tablets
- Notebook Computers
- DC-DC Current Sensing in Power Management
- Portable-/Battery-Powered Systems
- Medical Pulse Oximeters and Infusion Pumps
- Base-Station

**Ordering Information** appears at end of data sheet.

## Benefits and Features

- Supports Use of Small Current-Sense Resistors to Improve Power-Supply Conversion Efficiency and Measurement Accuracy
  - Input Bias Current of 80nA (max)
  - Very Low 2µV Input Offset Voltage (MAX44284F/H)
  - Extremely Low 50nV/°C Input Offset Tempco Coefficient
  - -0.1V to +36V Wide Input Common-Mode Range
  - Low 0.05% Gain Error
- Extends Battery Life
  - Low Supply Current of 21µA
  - 1.7V to 5.5V Single Supply
  - Shutdown Input (Independent of  $V_{DD}$ )
- Four Fixed Gain Options Simplify Design
  - 50V/V – MAX44284F
  - 100V/V – MAX44284H
  - 200V/V – MAX44284W
  - 500V/V – MAX44284E

For related parts and recommended products to use with this part, refer to [www.maximintegrated.com/MAX44284.related](http://www.maximintegrated.com/MAX44284.related).

## Typical Application Circuit

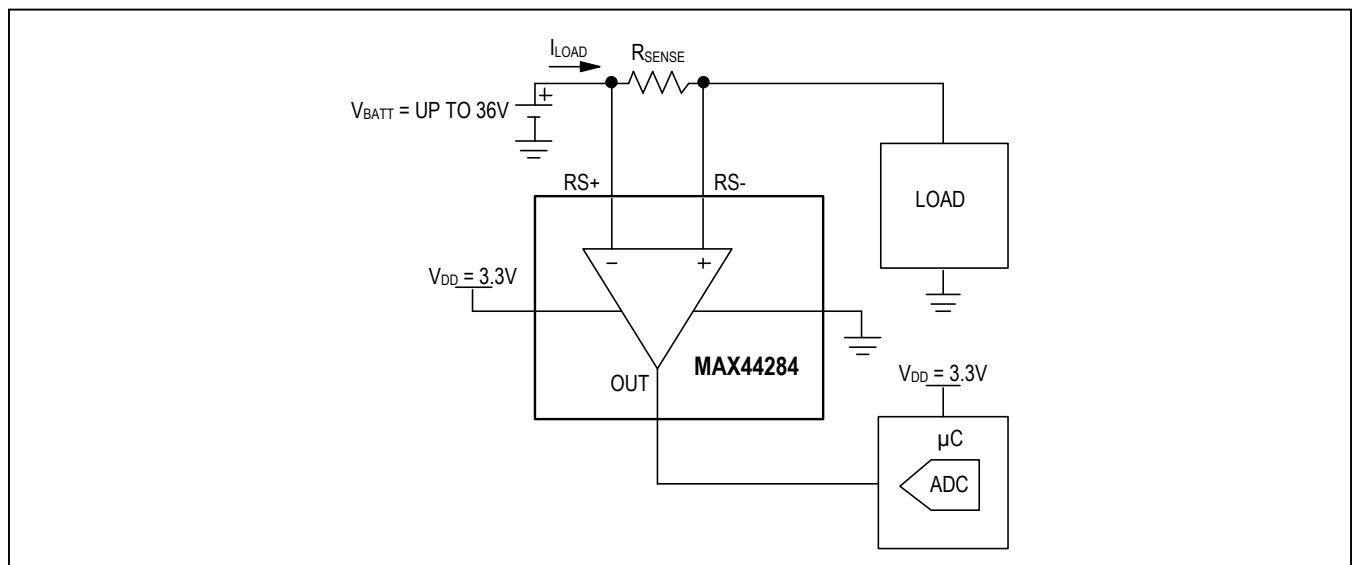

**Absolute Maximum Ratings**

V <sub>DD</sub> to GND .....	-0.3V to +6V	Operating Temperature Range .....	-40°C to +125°C
RS+, RS- to GND .....	-0.3V to +40V	Junction Temperature .....	+150°C
RS+ to RS- .....	±40V	Storage Temperature Range .....	-65°C to +150°C
OUT, SHDN to GND .....	-0.3V to (V <sub>DD</sub> + 0.3V)	Lead Temperature (soldering, 10s) .....	+300°C
Continuous Input Current (any pin) .....	±20mA	Soldering Temperature (reflow) .....	+260°C
Continuous Power Dissipation (T <sub>A</sub> = +70°C)			
WLP (derate 10.5mW/°C above +70°C) .....	840mW		
SOT23 (derate 4.3mW/°C above +70°C) .....	347.8mW		

Stresses beyond those listed under "Absolute Maximum Ratings" may cause permanent damage to the device. These are stress ratings only, and functional operation of the device at these or any other conditions beyond those indicated in the operational sections of the specifications is not implied. Exposure to absolute maximum rating conditions for extended periods may affect device reliability.

**Package Thermal Characteristics (Note 1)**

WLP  
Junction-to-Ambient Thermal Resistance (θ<sub>JA</sub>) .....70°C/W

**Note 1:** Package thermal resistances were obtained using the method described in JEDEC specification JESD51-7, using a four-layer board. For detailed information on package thermal considerations, refer to [www.maximintegrated.com/thermal-tutorial](http://www.maximintegrated.com/thermal-tutorial).

**Electrical Characteristics**

(V<sub>DD</sub> = 3.3V, V<sub>CM</sub> = 12V, V<sub>SENSE</sub> = V<sub>FS</sub>/2, V<sub>FS</sub> = (V<sub>DD</sub> - V<sub>OH</sub> - V<sub>OL</sub>)/Gain, V<sub>SHDN</sub> = V<sub>DD</sub>, R<sub>L</sub> = 10kΩ to GND, T<sub>A</sub> = -40°C to +125°C, unless otherwise noted. Typical values are at T<sub>A</sub> = +25°C.) (Note 2)

PARAMETER	SYMBOL	CONDITIONS	MIN	TYP	MAX	UNITS
<b>POWER SUPPLY</b>						
Supply Voltage	V <sub>DD</sub>	Guaranteed by PSRR	1.7		5.5	V
Shutdown Supply Current	I <sub>SHDN</sub>			0.3	0.8	µA
Supply Current	I <sub>DD</sub>	T <sub>A</sub> = +25°C, R <sub>L</sub> = ∞		21	31.2	µA
		-40°C ≤ T <sub>A</sub> ≤ +125°C, R <sub>L</sub> = ∞			41.5	
Power-Supply Rejection Ratio	PSRR	1.7V ≤ V <sub>DD</sub> ≤ 5.5V, V <sub>OUT</sub> = 1V	100	110		dB
Shutdown Voltage Low	V <sub>IL</sub>				0.55	V
Shutdown Voltage High	V <sub>IH</sub>		1.3			V
<b>DC CHARACTERISTICS</b>						
Input Common-Mode Voltage Range	V <sub>CM</sub>	Guaranteed by CMRR	-0.1		+36	V
Common-Mode Rejection Ratio (Note 5)	CMRR	-0.1V ≤ V <sub>CM</sub> ≤ +36V, V <sub>CM</sub> = RS-	91.3	140		dB
		+0.1V ≤ V <sub>CM</sub> ≤ +36V, V <sub>CM</sub> = RS- (Note 7)	120	145		
Input Bias Current	I <sub>RS+</sub> , I <sub>RS-</sub>			2	80	nA
Input Offset Current	I <sub>OS</sub>			2	50	nA

**Electrical Characteristics (continued)**

( $V_{DD} = 3.3V$ ,  $V_{CM} = 12V$ ,  $V_{SENSE} = V_{FS}/2$ ,  $V_{FS} = (V_{DD} - V_{OH} - V_{OL})/Gain$ ,  $V_{SHDN} = V_{DD}$ ,  $R_L = 10k\Omega$  to GND,  $T_A = -40^\circ C$  to  $+125^\circ C$ , unless otherwise noted. Typical values are at  $T_A = +25^\circ C$ .) (Note 2)

PARAMETER	SYMBOL	CONDITIONS	MIN	TYP	MAX	UNITS
Input Offset Voltage (Note 3)	$V_{OS}$	MAX44284F ( $T_A = +25^\circ C$ )		$\pm 2$	$\pm 10$	$\mu V$
		MAX44284F ( $-40^\circ C \leq T_A \leq +125^\circ C$ )			$\pm 28$	
		MAX44284H ( $T_A = +25^\circ C$ )		$\pm 2$	$\pm 12$	
		MAX44284H ( $-40^\circ C \leq T_A \leq +125^\circ C$ )			$\pm 28$	
		MAX44284W ( $T_A = +25^\circ C$ )		$\pm 10$	$\pm 20.5$	
		MAX44284W ( $-40^\circ C \leq T_A \leq +125^\circ C$ )			$\pm 38$	
		MAX44284E ( $T_A = +25^\circ C$ )		$\pm 15$	$\pm 26$	
		MAX44284E ( $-40^\circ C \leq T_A \leq +125^\circ C$ )			$\pm 40$	
Input Offset Voltage Temperature Drift	$TCV_{OS}$			50		$nV^\circ C$
Gain	G	MAX44284F		50		$V/V$
		MAX44284H		100		
		MAX44284W		200		
		MAX44284E		500		
Gain Error (Note 4)	GE	MAX44284F ( $T_A = +25^\circ C$ )		0.05	0.15	%
		MAX44284F ( $-40^\circ C \leq T_A \leq +125^\circ C$ )			0.20	
		MAX44284H ( $T_A = +25^\circ C$ )		0.05	0.15	
		MAX44284H ( $-40^\circ C \leq T_A \leq +125^\circ C$ )			0.26	
		MAX44284W ( $T_A = +25^\circ C$ )		0.05	0.15	
		MAX44284W ( $-40^\circ C \leq T_A \leq +125^\circ C$ )			0.35	
		MAX44284E ( $T_A = +25^\circ C$ )		0.05	0.16	
		MAX44284E ( $-40^\circ C \leq T_A \leq +125^\circ C$ )			0.39	
Output Voltage High	$V_{OH}$	$V_{OH} = V_{DD} - V_{OUT}$ , $R_L = 10k\Omega$ to GND		25	35	$mV$
		$I_{SOURCE} = 100\mu A$			20	
Output Voltage Low	$V_{OL}$	No load		0.3	1	$mV$
		$I_{SINK} = 100\mu A$			20	
Input Differential Impedance				6		$M\Omega$
Output Impedance				200		$m\Omega$

**Electrical Characteristics (continued)**

( $V_{DD} = 3.3V$ ,  $V_{CM} = 12V$ ,  $V_{SENSE} = V_{FS}/2$ ,  $V_{FS} = (V_{DD} - V_{OH} - V_{OL})/Gain$ ,  $V_{SHDN} = V_{DD}$ ,  $R_L = 10k\Omega$  to GND,  $T_A = -40^\circ C$  to  $+125^\circ C$ , unless otherwise noted. Typical values are at  $T_A = +25^\circ C$ .) (Note 2)

PARAMETER	SYMBOL	CONDITIONS	MIN	TYP	MAX	UNITS
<b>AC CHARACTERISTICS</b>						
Small-Signal Bandwidth	$BW_{3dB}$	MAX44284F		3		kHz
		MAX44284H		1.8		
		MAX44284W		1		
		MAX44284E		0.4		
Input Voltage-Noise Density	$e_n$	$f = 1kHz$		150		$nV/\sqrt{Hz}$
AC Common-Mode Rejection Ratio	AC CMRR	$f = 10kHz$ , 600mV <sub>p-p</sub> sinusoidal waveform		80		dB
Settling Time	$t_s$	$V_{OUT}$ from 250mV to 2.5V, Gain = 50, within 12-bit accuracy		1500		$\mu s$
		$V_{OUT}$ from 250mV to 2.5V, Gain = 100, within 12-bit accuracy		1500		
		$V_{OUT}$ from 250mV to 2.5V, Gain = 200, within 12-bit accuracy		1800		
		$V_{OUT}$ from 250mV to 2.5V, Gain = 500, within 12-bit accuracy		4000		
Capacitive Load	$C_L$	$R_{ISO} = 0\Omega$		500		pF
		$R_{ISO} = 20\Omega$		2200		

**Note 2:** All devices are 100% production tested at  $T_A = +25^\circ C$ . All temperature limits are guaranteed by design.

**Note 3:**  $V_{OS}$  is calculated by applying two values of  $V_{SENSE}$  (10% of full-scale range to 90% of full-scale range).

**Note 4:** Gain Error is calculated by applying two values of  $V_{SENSE}$  (10% of full-scale range to 90% of full-scale range) and calculating the error of the slope, vs. the ideal.

**Note 5:** CMRR measurement is done at  $V_{OUT} = V_{DD}/2$  condition.

**Note 6:** PSRR measurement is done at  $V_{OUT} = 1V$  condition.

**Note 7:** Parameter is guaranteed by design.

Typical Operating Characteristics

( $T_A = +25^\circ\text{C}$ , unless otherwise noted.)

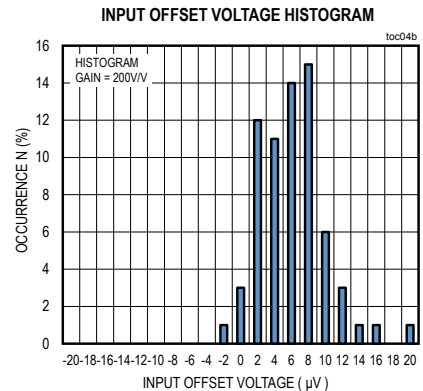
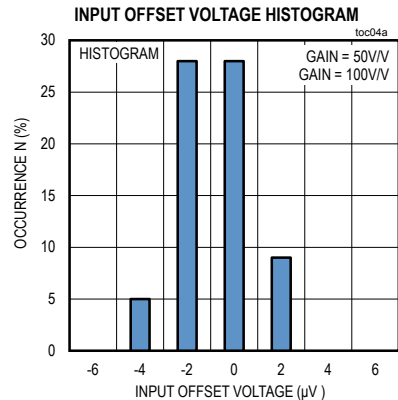
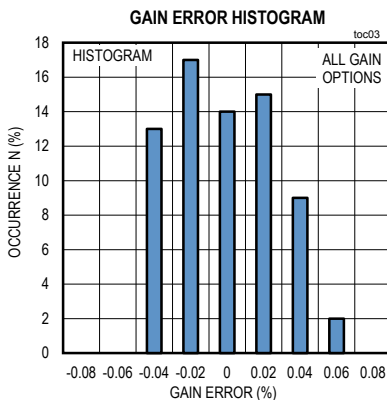
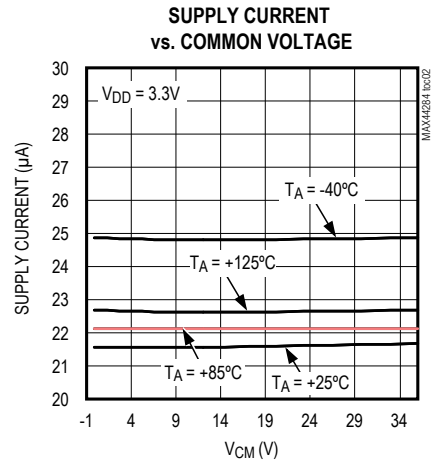
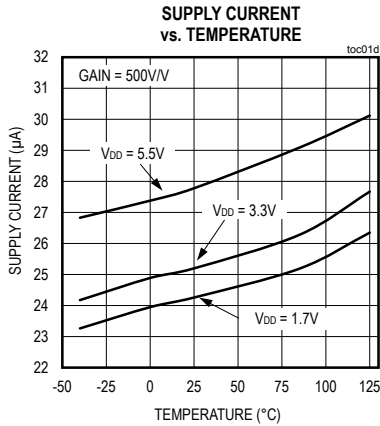
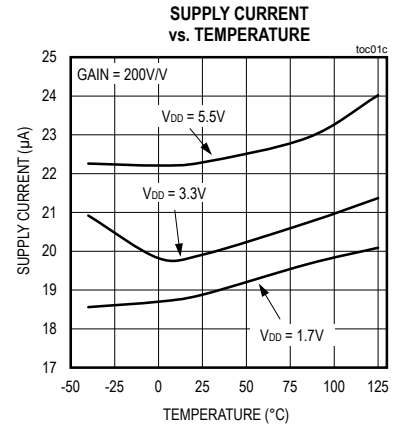
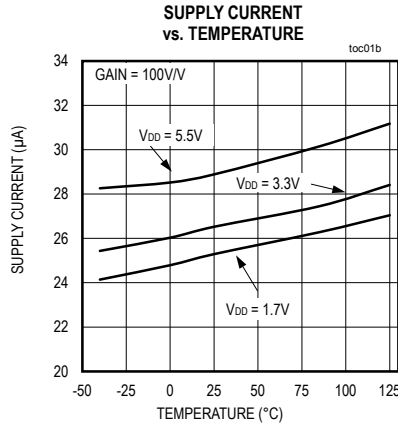
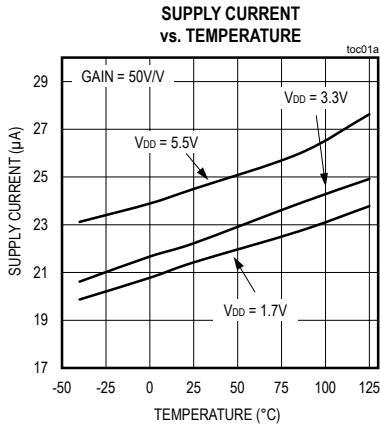

Typical Operating Characteristics (continued)

( $T_A = +25^\circ\text{C}$ , unless otherwise noted.)

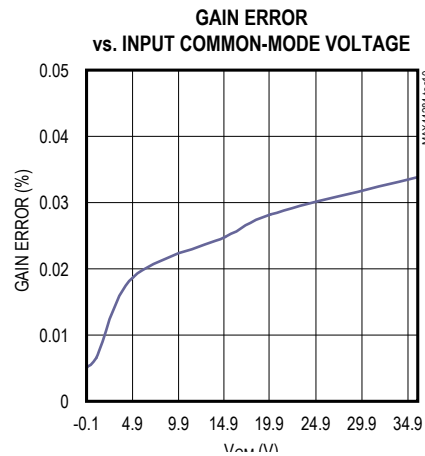
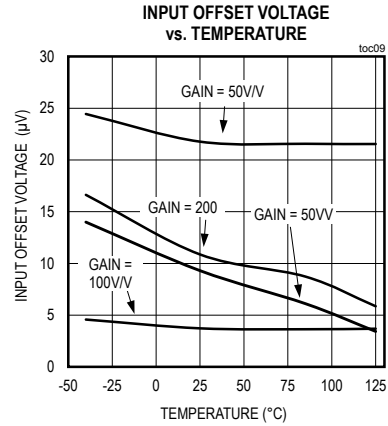
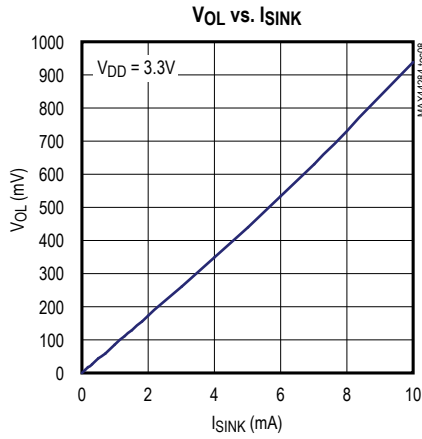
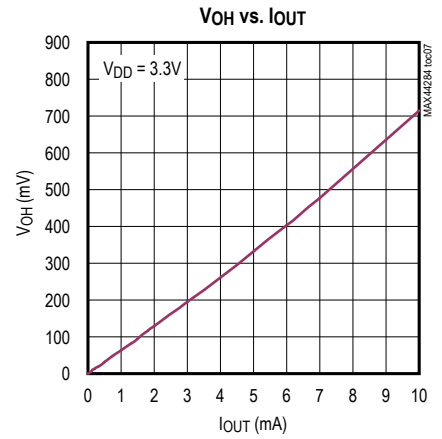
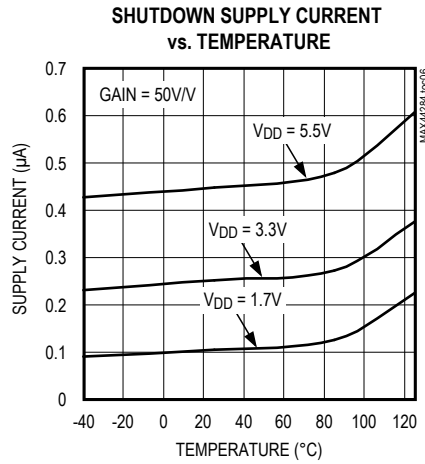
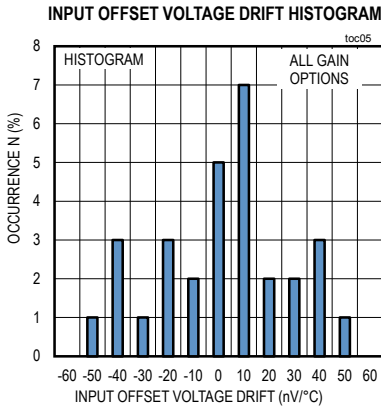

Typical Operating Characteristics (continued)

( $T_A = +25^\circ\text{C}$ , unless otherwise noted.)

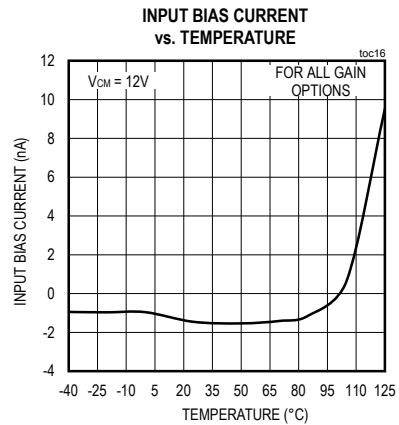
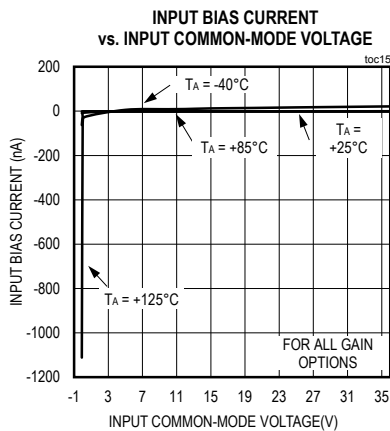
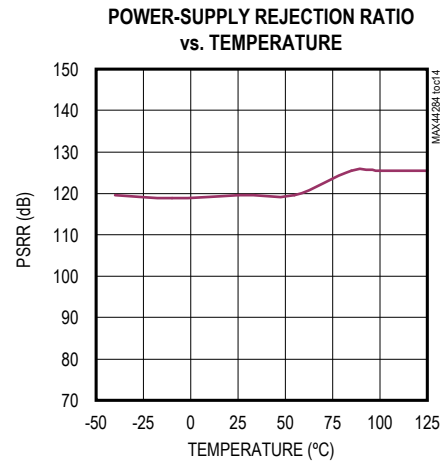
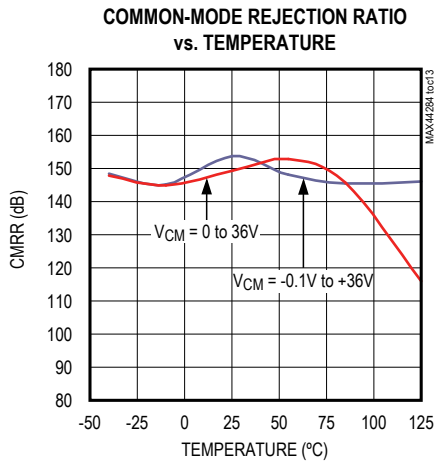
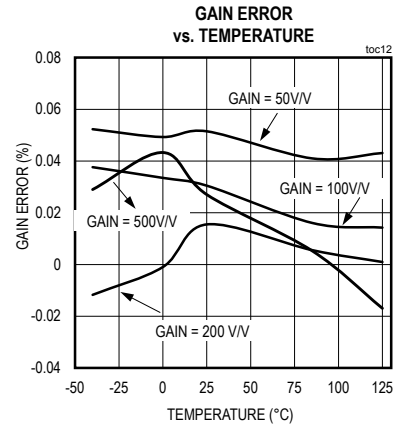
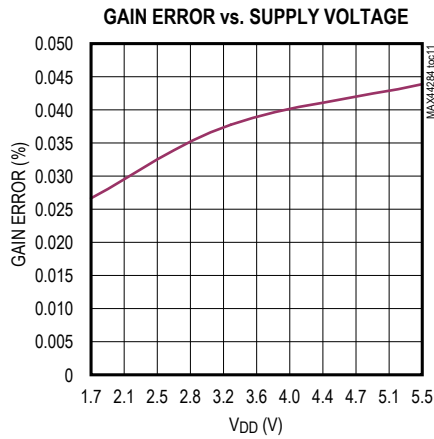

Typical Operating Characteristics (continued)

( $T_A = +25^\circ\text{C}$ , unless otherwise noted.)

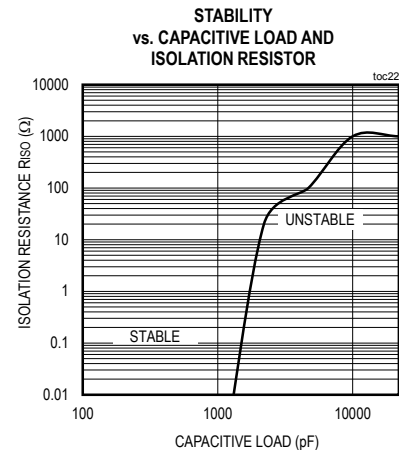
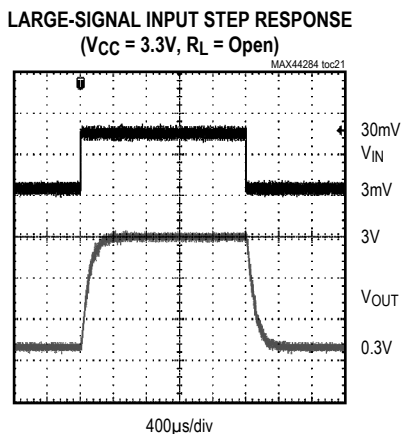
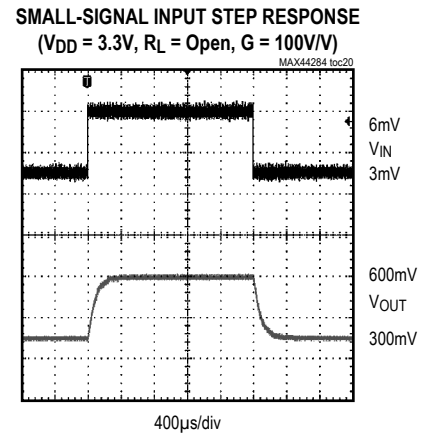
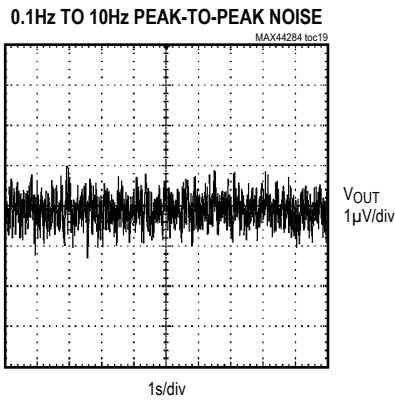
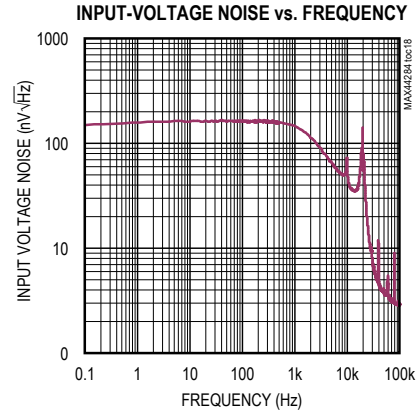
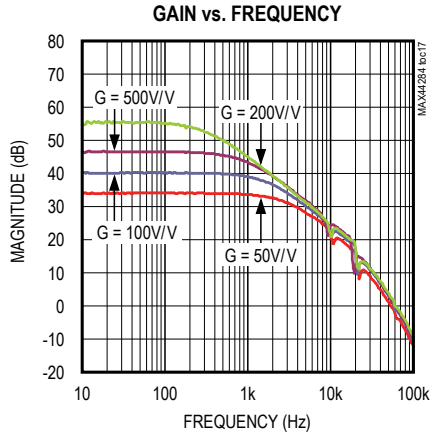



Pin Configurations

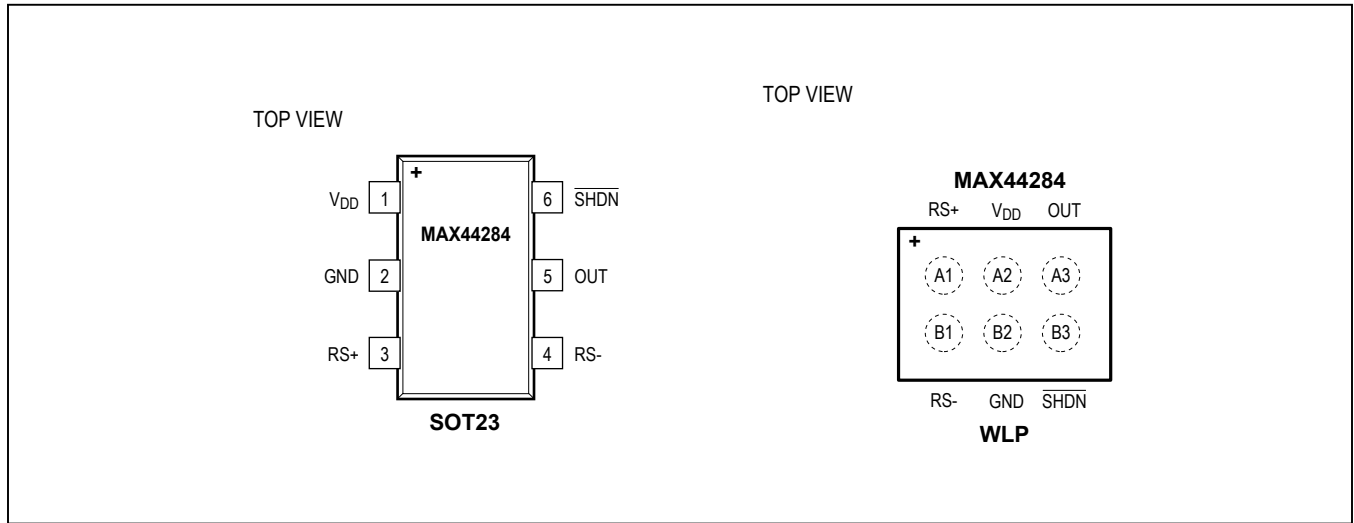

Pin Description

PIN	BUMP	NAME	FUNCTION
SOT23	WLP		
1	A2	V <sub>DD</sub>	Power-Supply Voltage Input. Bypass V <sub>DD</sub> to GND with 0.1μF and 4.7μF capacitors in parallel as close as possible to the device.
2	B2	GND	Ground
3	A1	RS+	External Sense Resistor Power-Side Connection
4	B1	RS-	External Sense Resistor Load-Side Connection
5	A3	OUT	Output Voltage. V <sub>OUT</sub> is proportional to V <sub>SENSE</sub> = V <sub>RS+</sub> - V <sub>RS-</sub> .
6	B3	SHDN	Active-Low Shutdown Input. Connect to V <sub>DD</sub> for normal operation.

## Detailed Description

The MAX44284 family features a single-supply; high-accuracy unidirectional, current-sense amplifier in various gain options and a -0.1V to 36V input common-mode range that is independent of supply voltage ( $V_{DD}$ ). The MAX44284 is ideal for many battery-powered, handheld devices because it uses only maximum 31.2 $\mu$ A quiescent supply current to extend battery life. The device's low input offset voltage, tight gain error, and low temperature drift characteristics allow the use of small-sense resistors for current measurements to improve power-supply conversion efficiency and accuracy of measurements. This feature allows monitoring of power-supply load current even if the rail is shorted to ground. High-side current monitoring does not interfere with the ground path of the load being measured, making the IC particularly useful in a wide range of high-reliability systems.

Because of its extended common-mode range below ground, this part can also be used as a low-side current sensing element.

### Shutdown

The MAX44284 features active-low logic shutdown input to reduce the supply current. Drive  $\overline{\text{SHDN}}$  high for normal operation. Drive  $\overline{\text{SHDN}}$  low to place the device in shutdown mode. In shutdown mode, the supply current drawn from the  $V_{DD}$  is less than 1 $\mu$ A (max).

### Precision

The MAX44284 uses capacitive-coupled Instrumentation amplifier architecture that enables the part to achieve over the top common-mode voltage ranges, high power efficiency, high gain accuracy, and low-power design.

### Low Offset Voltage and Low Gain Error

The MAX44284 utilizes Capacitive-Coupled Chopper Instrumentation Amplifier (CCIA) architecture to achieve a low-input offset voltage of less than 10 $\mu$ A. These techniques also enable extremely low-input offset voltage drift over time and temperature to 50nV/ $^{\circ}$ C. The precision  $V_{OS}$  specification allows accurate current measurements with lower values of current-sense resistors, thus reducing

power dissipation in battery-powered systems, as well as load regulation issues in low-voltage DC power supplies.

Working with error tolerances with very few internal blocks in this architecture is instrumental in achieving a gain error of less than 0.20% over the entire temperature range of -40 $^{\circ}$ C to +125 $^{\circ}$ C.

## Applications Information

### Input Differential Signal Range

The MAX44284's input structure is optimized for sensing small differential signals as low as 3.4mV full scale ( $V_{FS}$ ) for high efficiency with lowest power dissipation in the sense resistor, or 110mV full scale for high dynamic range. The input differential signal range is determined by the following equation for the MAX44284 family.

$$V_{(\text{SENSE RANGE})} = \frac{V_{DD}}{\text{GAIN}}$$

The input differential voltage range is estimated for  $V_{DD}$  from 1.7V to 5.5V for different gain values of the MAX44284 as shown in [Table 1](#)

Ideally, the maximum load current develops the full-scale sense voltage across the current-sense resistor. Choose the gain needed to yield the maximum output voltage required for the application:

$$V_{OUT} = \text{GAIN} \times V_{SENSE}$$

### Choosing the Sense Resistor

#### Voltage Loss

A high  $R_{SENSE}$  value causes the power-source voltage to drop due to IR loss. For minimal voltage loss, use the lowest  $R_{SENSE}$  value.

#### Accuracy

Use the below linear equation to calculate total error:

$$V_{OUT} = (\text{GAIN} \pm \text{GE}) \times V_{SENSE} \pm (\text{GAIN} \times V_{OS})$$

**Table 1.  $V_{SENSE}$  Input Range**

PART	GAIN (V/V)	$V_{SENSE}$ RANGE (mV) with $V_{DD}$ (1.7V)	$V_{SENSE}$ RANGE (mV) with $V_{DD}$ (5.5V)
MAX44284F	50	34	110
MAX44284H	100	17	55
MAX44284W	200	8.5	27.5
MAX44284E	500	3.4	11

A high  $R_{SENSE}$  value allows lower currents to be measured more accurately because offsets are less significant when the sense voltage is larger. Note that the tolerance and temperature coefficient of the chosen resistors directly affect the precision of any measurement system. For best performance, select  $R_{SENSE}$  to provide approximately maximum input differential sense voltage of 110mV (MAX44284F) or 55mV (MAX44284H) or 27.5mV (MAX44284W) or 11mV (MAX44284E) of sense voltage for the full-scale current in each application. Sense resistors of 5mΩ to 100mΩ are available with 1% accuracy or better.

**Efficiency and Power Dissipation**

At high current levels, the  $I^2R$  losses in  $R_{SENSE}$  can be significant. This should be taken into consideration when choosing the resistor value and its power dissipation (wattage) rating. The sense resistor’s value will drift if it is allowed to heat up excessively. The precision  $V_{OS}$  of the MAX44284 allows the use of small sense resistors to reduce power dissipation and reduce hot spots.

**Kelvin Connections**

Because of the high currents that may flow through  $R_{SENSE}$  based on the application, take care to eliminate solder and parasitic trace resistance from causing errors in the sense voltage. Either use a four-terminal current-sense resistor or use Kelvin (force and sense) PCB layout techniques.

**Input Filtering**

Some applications of current-sense amplifiers need to measure currents accurately even in the presence of both differential and common-mode ripple, as well as a wide variety of input transient conditions.

The MAX44284 allows two methods of filtering to help improve performance in the presence of input common-mode voltage and input differential voltage transients. [Figure 1](#) shows a differential input filter. The capacitor  $C_{IN}$  across  $RS+$  and  $RS-$  along with the resistor  $R_{IN}$  helps filter against input differential voltages and prevents them from reaching the MAX44284. The corner frequency of this filter is determined by the choice of  $R_{IN}$ ,  $C_{IN}$ . [Figure 2](#) shows a common-mode input filter. The choice of capacitance depends on corner frequency after  $R_{IN}$  is chosen. In case of mismatch or error in application design, an

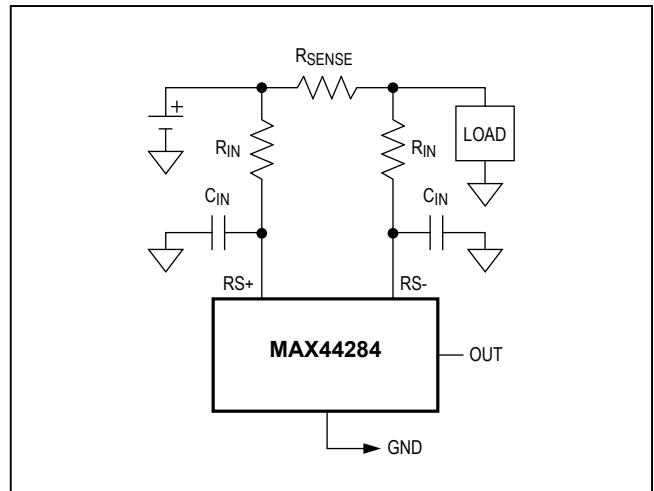

Figure 1. Differential Input Filtering

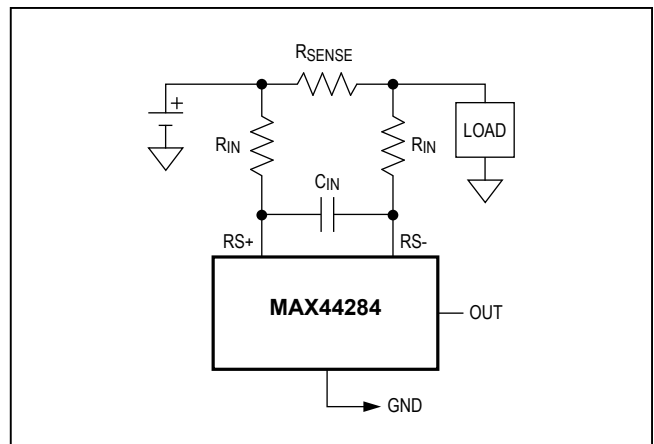

Figure 2. Input Common-Mode Filtering

additional DC error is accumulated as offset voltage and increased gain error.

$$V_{OS} = (R_{IN} \times I_{OFFSET}) + (DR_{IN} \times I_{BIAS})$$

$DR_{IN}$  is the resistance mismatch in  $R_{IN}$  at  $RS+$  and  $RS-$ . If  $DR_{IN}$  is too small, its effect can be neglected. Since  $I_{OFFSET}$  of the MAX44284 is smaller than 2nA, and if we want to make sure  $V_{OS}$  is lesser than 1μV range, choosing

$$R_{IN} < (V_{OS} \div I_{OFFSET})$$

For gain error, it depends on its input impedance and  $R_{IN}$ .

$$\text{GainError} = \frac{-R_{IN}}{2 \times Z_{IN}}$$

Avoid additional gain error shift due to the effect of  $R_{IN}$ . For gain error, the MAX44284 is 0.15%. If the margin of additional effect of  $R_{IN}$  results in a gain error shift of less than 0.02%, then:

$$R_{IN} < \frac{0.02\%}{2 \times Z_{IN}} = 600\Omega$$

So  $R_{IN}$  can be chosen  $\leq 500\Omega$ .

**Output Filtering**

The internal architecture of the MAX44284 suppresses the DC offset, 1/f noise, and accumulates at higher frequencies so that they can be filtered out. Hence, minute AC disturbances can be observed at 10kHz and 20kHz. It is recommended to add an output filter after the MAX44284 to avoid noise and unwanted frequency disturbances at the output with 5kHz -3dB  $f_c$  (see [Figure 3](#)).

(Suggested values of C and R : 2.2nF and 1.8k $\Omega$ , respectively.)

**Bidirectional Application**

Battery-powered systems may require a precise bidirectional current-sense amplifier to accurately monitor the battery's charge and discharge currents. Measurements of the two separate outputs with respect to GND yield an accurate measure of the charge and discharge currents respectively ([Figure 4](#)).

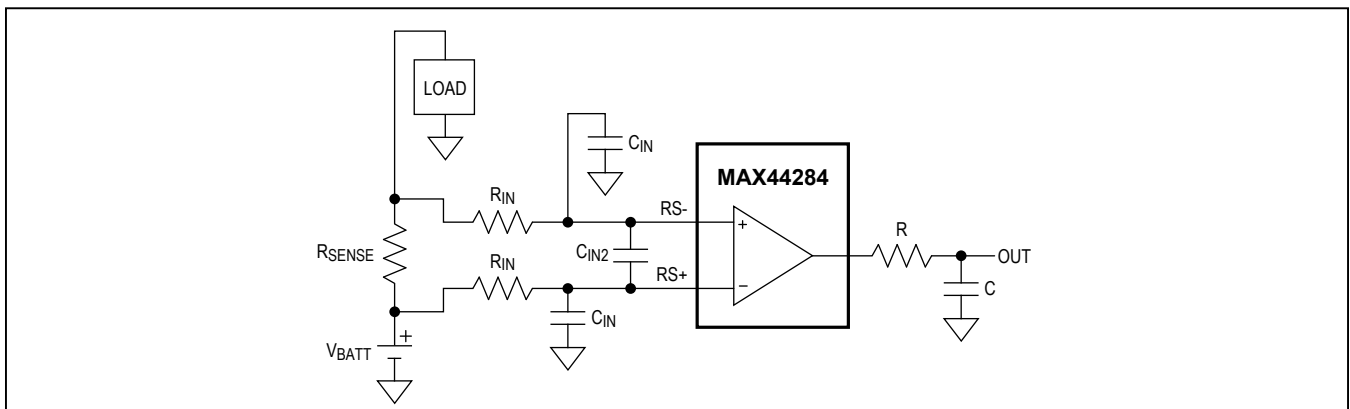

Figure 3. Filtering

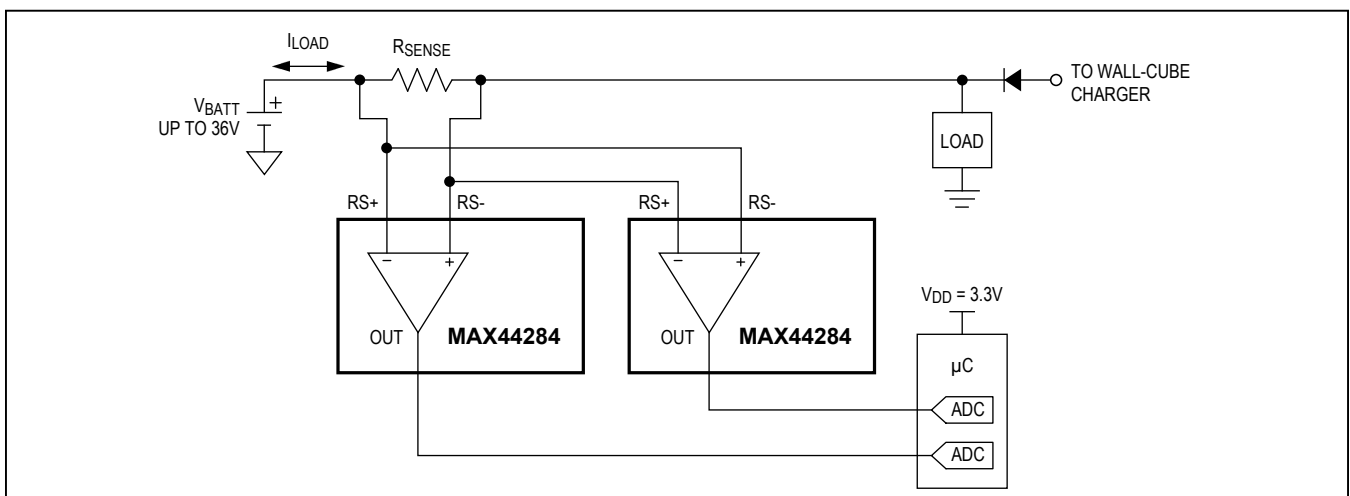

Figure 4. Bidirectional Application

MAX44284

36V, Input Common-Mode, High-Precision,  
Low-Power Current-Sense Amplifier

## Ordering Information

PART	GAIN (V/V)	TEMP RANGE	PIN-PACKAGE	TOP MARK
MAX44284FAWT+	50	-40°C to +125°C	6 WLP	+CX
MAX44284FAUT+	50	-40°C to +125°C	6 SOT23	+ACSF
MAX44284HAWT+	100	-40°C to +125°C	6 WLP	+CY
MAX44284HAUT+	100	-40°C to +125°C	6 SOT23	+ACSG
MAX44284WAWT+	200	-40°C to +125°C	6 WLP	+CZ
MAX44284WAUT+	200	-40°C to +125°C	6 SOT23	+ACSH
MAX44284EAWT+	500	-40°C to +125°C	6 WLP	+DA
MAX44284EAUT+	500	-40°C to +125°C	6 SOT23	+ACSI

+Denotes a lead(Pb)-free/RoHS-compliant package

## Package Information

For the latest package outline information and land patterns (footprints), go to [www.maximintegrated.com/packages](http://www.maximintegrated.com/packages). Note that a "+", "#", or "-" in the package code indicates RoHS status only. Package drawings may show a different suffix character, but the drawing pertains to the package regardless of RoHS status.

PACKAGE TYPE	PACKAGE CODE	OUTLINE NO.	LAND PATTERN NO.
6 WLP	W60A1+1	<a href="#">21-0656</a>	Refer to <a href="#">Application Note 1891</a>
6 SOT23	U6+1	<a href="#">21-0058</a>	<a href="#">90-0175</a>

## Chip Information

PROCESS: BiCMOS

## Revision History

REVISION NUMBER	REVISION DATE	DESCRIPTION	PAGES CHANGED
0	12/13	Initial release	—
1	5/14	Updated <i>Typical Operating Characteristics</i> and the <i>Ordering Information</i>	8, 13
2	6/14	Corrected <i>General Description</i> and updated <i>Electrical Characteristics</i> globals	1–4
3	9/14	Released MAX44284E and updated the <i>Electrical Characteristics</i>	3, 13
4	1/15	Revised <i>Benefits and Features</i> section	1

For pricing, delivery, and ordering information, please contact Maxim Direct at 1-888-629-4642, or visit Maxim Integrated's website at [www.maximintegrated.com](http://www.maximintegrated.com).

Maxim Integrated cannot assume responsibility for use of any circuitry other than circuitry entirely embodied in a Maxim Integrated product. No circuit patent licenses are implied. Maxim Integrated reserves the right to change the circuitry and specifications without notice at any time. The parametric values (min and max limits) shown in the *Electrical Characteristics* table are guaranteed. Other parametric values quoted in this data sheet are provided for guidance.

Компания «Океан Электроники» предлагает заключение долгосрочных отношений при поставках импортных электронных компонентов на взаимовыгодных условиях!

Наши преимущества:

- Поставка оригинальных импортных электронных компонентов напрямую с производств Америки, Европы и Азии, а так же с крупнейших складов мира;
- Широкая линейка поставок активных и пассивных импортных электронных компонентов (более 30 млн. наименований);
- Поставка сложных, дефицитных, либо снятых с производства позиций;
- Оперативные сроки поставки под заказ (от 5 рабочих дней);
- Экспресс доставка в любую точку России;
- Помощь Конструкторского Отдела и консультации квалифицированных инженеров;
- Техническая поддержка проекта, помощь в подборе аналогов, поставка прототипов;
- Поставка электронных компонентов под контролем ВП;
- Система менеджмента качества сертифицирована по Международному стандарту ISO 9001;
- При необходимости вся продукция военного и аэрокосмического назначения проходит испытания и сертификацию в лаборатории (по согласованию с заказчиком);
- Поставка специализированных компонентов военного и аэрокосмического уровня качества (Xilinx, Altera, Analog Devices, Intersil, Interpoint, Microsemi, Actel, Aeroflex, Peregrine, VPT, Syfer, Eurofarad, Texas Instruments, MS Kennedy, Miteq, Cobham, E2V, MA-COM, Hittite, Mini-Circuits, General Dynamics и др.);

Компания «Океан Электроники» является официальным дистрибьютором и эксклюзивным представителем в России одного из крупнейших производителей разъемов военного и аэрокосмического назначения «JONHON», а так же официальным дистрибьютором и эксклюзивным представителем в России производителя высокотехнологичных и надежных решений для передачи СВЧ сигналов «FORSTAR».



## JONHON

«JONHON» (основан в 1970 г.)

Разъемы специального, военного и аэрокосмического назначения:

(Применяются в военной, авиационной, аэрокосмической, морской, железнодорожной, горно- и нефтедобывающей отраслях промышленности)

«FORSTAR» (основан в 1998 г.)

ВЧ соединители, коаксиальные кабели, кабельные сборки и микроволновые компоненты:

(Применяются в телекоммуникациях гражданского и специального назначения, в средствах связи, РЛС, а так же военной, авиационной и аэрокосмической отраслях промышленности).



Телефон: 8 (812) 309-75-97 (многоканальный)

Факс: 8 (812) 320-03-32

Электронная почта: [ocean@oceanchips.ru](mailto:ocean@oceanchips.ru)

Web: <http://oceanchips.ru/>

Адрес: 198099, г. Санкт-Петербург, ул. Калинина, д. 2, корп. 4, лит. А