

# General Specifications

## Electrical Capacity (Resistive Load)

**Power Level:** 3A @ 250V AC

## Other Ratings

<b>Contact Resistance:</b>	20 milliohms maximum
<b>Insulation Resistance:</b>	1,000 megohms minimum @ 500V DC
<b>Dielectric Strength:</b>	1,000V AC minimum between contacts for 1 minute minimum; 1,500V AC minimum between contacts & case for 1 minute minimum
<b>Mechanical Life:</b>	30,000 cycles minimum
<b>Electrical Life:</b>	10,000 cycles minimum
<b>Static Capability:</b>	Withstands 15 kilovolts minimum ESD minimum (for CKM models only)
<b>Nominal Operating Torque:</b>	16mm Bushing (CKM models): .04 mNm (5.67 oz•in) for Flat Key .08 mNm (11.33 oz•in) for Tubular Key 19mm Bushing (CKL models): .05 mNm (7.08 oz•in) for Flat Key .07 mNm (9.91 oz•in) for Tubular Key
<b>Contact Timing:</b>	Break-before-make
<b>Angle of Throw:</b>	90° for 2-position & 45° for 3-position

## Materials & Finishes

<b>Keys for CKM:</b>	Brass with nickel plating with ABS handle
<b>Keys for CKL:</b>	Brass with nickel plating for tubular key; brass with chrome plating for flat key
<b>Housing/Bushing:</b>	Glass fiber reinforced PBT for CKM models; zinc alloy with chrome plating for CKL
<b>Base:</b>	LCP (Liquid Crystal Polymer)
<b>Contact Terminals:</b>	Copper with silver plating
<b>Common Terminals:</b>	Copper with silver plating
<b>Movable Contactor:</b>	Copper
<b>Movable Contacts:</b>	Silver

## Environmental Data

<b>Operating Temperature Range:</b>	-25°C through +70°C (-13°F through +158°F)
<b>Humidity:</b>	90 ~ 95% humidity for 240 hours @ 40°C (104°F) for CKM; 90 ~ 95% humidity for 96 hours @ 40°C (104°F) for CKL
<b>Vibration:</b>	10 ~ 55Hz with peak-to-peak amplitude of 1.5mm for CKM or 0.7mm for CKL traversing the frequency range & returning in 1 minute; 3 right angled directions for 2 hours
<b>Shock:</b>	50G (490m/s <sup>2</sup> ) acceleration for CKM; 30G (294m/s <sup>2</sup> ) acceleration for CKL; (CKM & CKL tested in 6 right angled directions, with 5 shocks in each direction)

## Installation

<b>Mounting Torque:</b>	1.5 Nm (13.28 lb•in) maximum
<b>Soldering Time &amp; Temperature:</b>	Manual Soldering: See Profile A in Supplement section.

## Distinctive Characteristics

High insulating material for 16mm CKM models withstands over 15 kilovolts of electrostatic discharge, thus providing antistatic feature.

Rugged, die cast housing 19mm CKL models designed for higher security requirements.

Vertically rotating switching mechanism combines with self-cleaning sliding contacts for high reliability and long operating life.

16mm and 19mm diameter bushings available.

CKL and CKM on-off-on models with tubular keys have push-and-lock mechanism which allows contactor to drop and slide over stationary contacts.

Available in both flat and tubular key styles; flat key is reversible for easier setting.

Epoxy sealed terminals prevent entry of flux and other contaminants.

Interior construction provides seal for contact area.

High dielectric strength of 1,500 volts between contacts and case.



Actual Size CKM with Tubular Key



Toggles

Rockers

Pushbuttons

Illuminated PB

Programmable

**F**  
Keylocks

Rotaries

Slides

Tactiles

Tilt

Touch

Indicators

Accessories

Supplement

### TYPICAL SWITCH ORDERING EXAMPLE



### DESCRIPTION FOR TYPICAL ORDERING EXAMPLE

**CKM12AFW01**

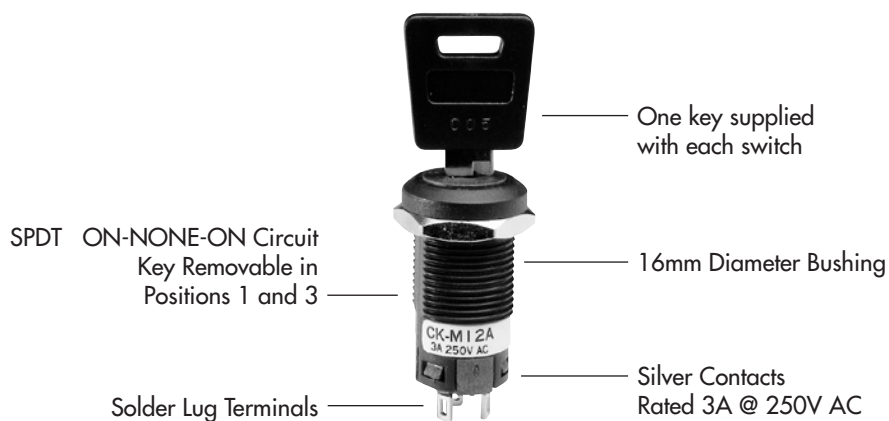

## POLES, CIRCUITS & KEY-REMOVABLE POSITIONS

Pole & Throw	Model	Key Positions			Connected Terminals (Terminal numbers are on switch)			Schematic	☉ = Key Removable ● = Not Removable ✓ = Maximum Arc
		Pos 1	Pos 2	Pos 3	Pos 1	Pos 2	Pos 3		
SPDT	CKM12A CKL12A	ON	NONE	ON	COM-1	—	COM-2		
SPDT	CKM12B CKL12B	ON	NONE	ON	COM-1	—	COM-2		
SPDT	CKM13E CKL13E	ON	OFF	ON	COM-1	OPEN	COM-2		

## KEYS

### F Flat Key

#### AT4147 for CKM 16mm

Brass with Nickel Plating key base & ABS key handle

#### AT4153 for CKL 19mm

Brass with Chrome Plating (crosshatch texture on handle)

One key provided with each switch (no master key available)  
For ordering additional keys, indicate the same key number that is engraved on the face of your switch.

Randomly assigned key number (001 through 010 for CKM models & 001 through 025 for CKL models).

Typical Key Ordering Example: AT4153-001

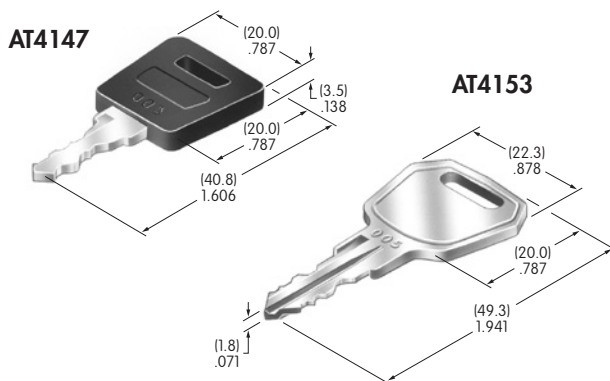

### T Tubular Key (must be pressed inward to actuate)

#### AT4146 for CKM 16mm

Brass with Nickel Plating key base & ABS key handle

#### AT4152 for CKL 19mm

Brass with Nickel Plating (smooth)

One key provided with each switch (no master key available)  
For ordering additional keys, indicate the same key number that is engraved on the face of your switch.

Randomly assigned key number (001 through 025 for CKM models & 001 through 050 for CKL models).

Typical Key Ordering Example: AT4146-001



## CONTACT MATERIALS, RATINGS & TERMINALS

**W** Silver over Silver  
Power Level 3A @ 250V AC

**01** Solder Lug Terminals

Solder Lug Terminal  
for CKM



Solder Lug Terminal  
for CKL



## TYPICAL SWITCH DIMENSIONS

### 16mm Bushing • Flat Key



**90°  
Angular  
Throw**



**45°  
Angular  
Throw**

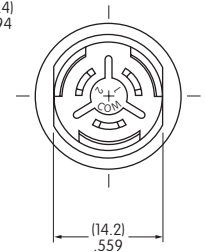
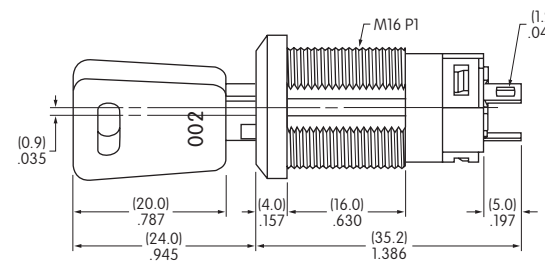

**CKM12AFW01**

### 16mm Bushing • Tubular Key



**90°  
Angular  
Throw**

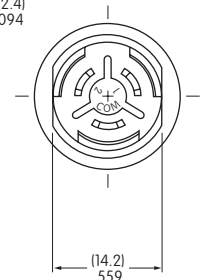
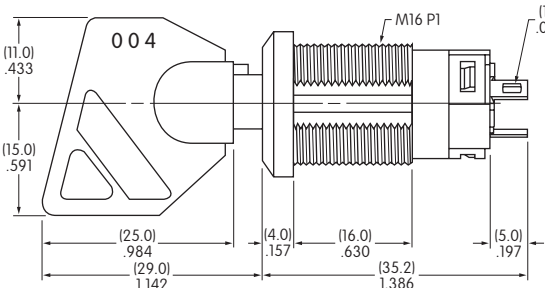

**45°  
Angular  
Throw**

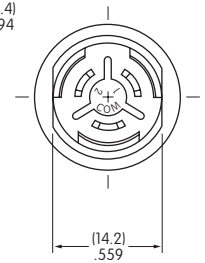
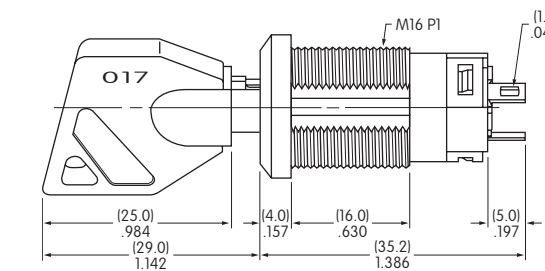

**CKM13ETW01**

## PANEL CUTOUT & STANDARD HARDWARE FOR 16MM BUSHING

Maximum Effective  
Panel Thickness:  
.469" (11.9mm)



**AT016  
16mm Hex Mounting Nut  
for CKM**

1 included with each switch  
Steel

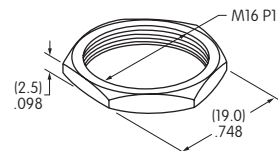

## TYPICAL SWITCH DIMENSIONS

### 19mm Bushing • Flat Key

**90°  
Angular  
Throw**

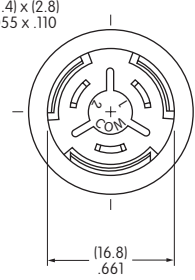

**CKL12AFW01**

**45°  
Angular  
Throw**

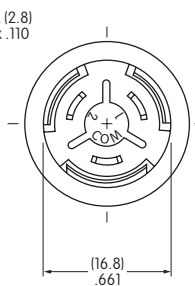
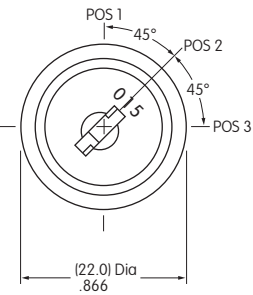

### 19mm Bushing • Tubular Key

**90°  
Angular  
Throw**

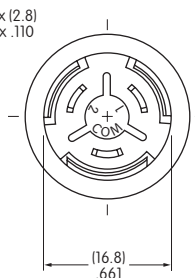
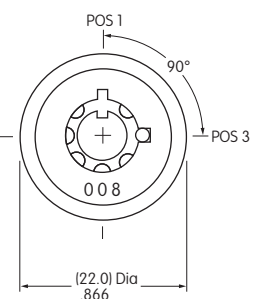

**CKL13ETW01**

**45°  
Angular  
Throw**

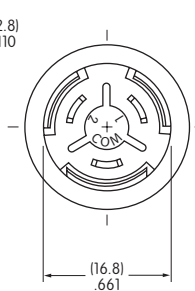

## PANEL CUTOUT & STANDARD HARDWARE FOR 19MM BUSHING

Maximum Effective  
Panel Thickness:  
.496" (12.6mm)

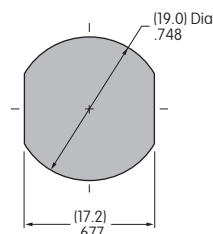

**AT019  
19mm Hex Mounting Nut  
for CKL**

1 included with each switch  
Steel

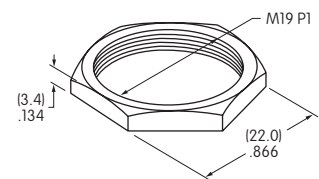

Компания «Океан Электроники» предлагает заключение долгосрочных отношений при поставках импортных электронных компонентов на взаимовыгодных условиях!

Наши преимущества:

- Поставка оригинальных импортных электронных компонентов напрямую с производств Америки, Европы и Азии, а так же с крупнейших складов мира;
- Широкая линейка поставок активных и пассивных импортных электронных компонентов (более 30 млн. наименований);
- Поставка сложных, дефицитных, либо снятых с производства позиций;
- Оперативные сроки поставки под заказ (от 5 рабочих дней);
- Экспресс доставка в любую точку России;
- Помощь Конструкторского Отдела и консультации квалифицированных инженеров;
- Техническая поддержка проекта, помощь в подборе аналогов, поставка прототипов;
- Поставка электронных компонентов под контролем ВП;
- Система менеджмента качества сертифицирована по Международному стандарту ISO 9001;
- При необходимости вся продукция военного и аэрокосмического назначения проходит испытания и сертификацию в лаборатории (по согласованию с заказчиком);
- Поставка специализированных компонентов военного и аэрокосмического уровня качества (Xilinx, Altera, Analog Devices, Intersil, Interpoint, Microsemi, Actel, Aeroflex, Peregrine, VPT, Syfer, Eurofarad, Texas Instruments, MS Kennedy, Miteq, Cobham, E2V, MA-COM, Hittite, Mini-Circuits, General Dynamics и др.);

Компания «Океан Электроники» является официальным дистрибьютором и эксклюзивным представителем в России одного из крупнейших производителей разъемов военного и аэрокосмического назначения «JONHON», а так же официальным дистрибьютором и эксклюзивным представителем в России производителя высокотехнологичных и надежных решений для передачи СВЧ сигналов «FORSTAR».



## JONHON

«JONHON» (основан в 1970 г.)

Разъемы специального, военного и аэрокосмического назначения:

(Применяются в военной, авиационной, аэрокосмической, морской, железнодорожной, горно- и нефтедобывающей отраслях промышленности)

«FORSTAR» (основан в 1998 г.)

ВЧ соединители, коаксиальные кабели, кабельные сборки и микроволновые компоненты:

(Применяются в телекоммуникациях гражданского и специального назначения, в средствах связи, РЛС, а так же военной, авиационной и аэрокосмической отраслях промышленности).



Телефон: 8 (812) 309-75-97 (многоканальный)

Факс: 8 (812) 320-03-32

Электронная почта: [ocean@oceanchips.ru](mailto:ocean@oceanchips.ru)

Web: <http://oceanchips.ru/>

Адрес: 198099, г. Санкт-Петербург, ул. Калинина, д. 2, корп. 4, лит. А