

New

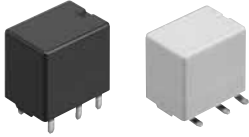

Compliance with RoHS Directive

## FEATURES

1. Best space savings in its class.
2. Compact and high-capacity 30A load switching.
3. Full line up (High heat-resistant type and SMD type)
4. Terminals for PC board pattern designs are easily allocated.

## TYPICAL APPLICATIONS

Defogger, Seat heater, Head lamp, Fog lamp, Fan motor, etc.

## ORDERING INFORMATION

ACNM					
CN-M relay					
Contact arrangement*1					
1: 1 Form C					
3: 1 Form A					
5: 1 Form C high heat-resistant type					
7: 1 Form A high heat-resistant type					
Pick-up voltage					
1: Max. 7.2V DC					
Coil voltage (DC)					
12: 12V					
Terminal shape					
Nil: PC board terminal					
SA: Surface-mount terminal					
Packing style*2					
Nil: Tube packing					
X: Tape and reel packing					
(Reverse NO terminal direction in pull-out direction)					
Z: Tape and reel packing					
(Normal NO terminal direction in pull-out direction)					

Notes: \*1. Surface-mount terminal type is available in high heat-resistant type only.

\*2. Tube packing: PC board terminal type only  
Tape and reel packing: Surface-mount type only

## TYPES

### 1. PC board terminal type

Contact arrangement	Nominal coil voltage	Part No.	
		Standard type	High heat-resistant type
1 Form A	12V DC	ACNM3112	ACNM7112
1 Form C		ACNM1112	ACNM5112

Standard packing; Carton (tube): 50 pcs.; Case: 1,500 pcs.

### 2. Surface-mount terminal type

Contact arrangement	Nominal coil voltage	Part No.
		High heat-resistant type
1 Form A	12V DC	ACNM7112SAX
		ACNM7112SAZ
1 Form C		ACNM5112SAX
		ACNM5112SAZ

Standard packing; Carton (tape and reel): 200 pcs.; Case: 600 pcs.

Notes: \*1. Surface-mount terminal type is available in high heat-resistant type only.

\*2. An "X" at the end of the part number indicates, for tape and reel packing, reverse NO terminal direction in pull-out direction.  
A "Z" at the end of the part number indicates, for tape and reel packing, normal NO terminal direction in pull-out direction.

# CN-M (ACNM)

## RATING

### 1. Coil data

Nominal coil voltage	Pick-up voltage (at 20°C 68°F)	Drop-out voltage (at 20°C 68°F)	Nominal operating current [ $\pm 10\%$ ] (at 20°C 68°F)	Coil resistance [ $\pm 10\%$ ] (at 20°C 68°F)	Nominal operating power (at 20°C 68°F)	Usable voltage range
12 V DC	Max. 7.2 V DC (Initial)	Min. 1.0 V DC (Initial)	53.3 mA	225 $\Omega$	640 mW	10 to 16 V DC

### 2. Specifications

Characteristics	Item	Specifications	
Contact	Arrangement	1 Form A, 1 Form C	
	Contact resistance (Initial)	Typical 5m $\Omega$ (By voltage drop 6 V DC 1 A)	
	Contact material	Ag alloy (Cadmium free)	
Rating	Nominal switching capacity (resistive load)	N.O.: 30A 14V DC, N.C.: 15A 14V DC	
	Max. carrying current (at 14V DC)	N.O. 30A/1 h, 40A/2 min. at 20°C 68°F 25A/1 h, 35A/2 min. at 85°C 185°F 20A/1 h, 30A/2 min. at 110°C 230°F (High heat-resistant type)	
		N.C. 25A/1 h, 30A/2 min. at 20°C 68°F 20A/1 h, 25A/2 min. at 85°C 185°F 15A/1 h, 20A/2 min. at 110°C 230°F (High heat-resistant type)	
		Nominal operating power	640 mW
	Min. switching capacity (resistive load)*	1A 12V DC	
Electrical characteristics	Insulation resistance (Initial)	Min. 100 M $\Omega$ (at 500 V DC)	
	Breakdown voltage (Initial)	Between open contacts	500 Vrms for 1 min. (Detection current: 10mA)
		Between contacts and coil	500 Vrms for 1 min. (Detection current: 10mA)
	Operate time (at nominal voltage)	Max. 10ms (at 20°C 68°F, excluding contact bounce time) (Initial)	
Release time (at nominal voltage)	Max. 10ms (at 20°C 68°F, excluding contact bounce time) (Initial) (without diode)		
Mechanical characteristics	Shock resistance	Functional	Min. 100 m/s <sup>2</sup> {10G} (Half-wave pulse of sine wave: 11ms; detection time: 10 $\mu$ s)
		Destructive	Min. 1,000 m/s <sup>2</sup> {100G} (Half-wave pulse of sine wave: 6ms)
	Vibration resistance	Functional	10 Hz to 100 Hz, Min. 44.1m/s <sup>2</sup> {4.5G} (Detection time: 10 $\mu$ s)
		Destructive	10 Hz to 500 Hz, Min. 44.1m/s <sup>2</sup> {4.5G} Time of vibration for each direction; X, Y direction: 2 hours, Z direction: 4 hours
Expected life	Mechanical	Min. 10 <sup>7</sup> (at 120 cpm)	
		<Resistive load> Min. 10 <sup>5</sup> (At nominal switching capacity, operating frequency: 1s ON, 2s OFF)	
		<Motor load> Min. 2 $\times$ 10 <sup>5</sup> : at 80 A (inrush), 16 A (steady), 14 V DC (Operating frequency: 2s ON, 6s OFF)	
		<Lamp load> Min. 10 <sup>5</sup> : at 84 A (inrush), 12 A (steady), 14 V DC (Operating frequency: 1s ON, 14s OFF)	
Conditions	Conditions for operation, transport and storage	Standard type; Ambient temp: -40°C to +85°C -40°F to +185°F, Humidity: 5 to 85% R.H.	
		High heat-resistant type; Ambient temp: -40°C to +110°C -40°F to +230°F, Humidity: 2 to 85% R.H. (Not freezing and condensing at low temperature)	
Unit weight		Approx. 5.5 g .19 oz	

Note: \*This value can change due to the switching frequency, environmental conditions, and desired reliability level, therefore it is recommended to check this with the actual load.

## REFERENCE DATA

### 1-(1). Coil temperature rise

Sample: ACNM1112, 3pcs  
Measured portion: Inside the coil  
Contact carrying current: 10A, 20A, 30A  
Ambient temperature: 26°C 78.8°F

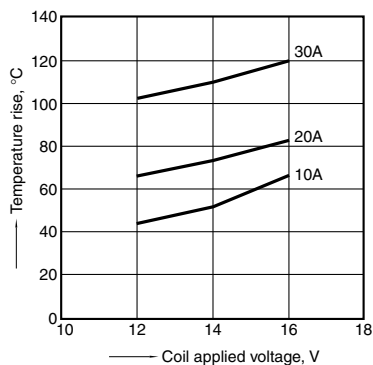

### 1-(2). Coil temperature rise

Sample: ACNM7112, 3pcs  
Measured portion: Inside the coil  
Contact carrying current: 10A, 20A  
Ambient temperature: 110°C 230°F

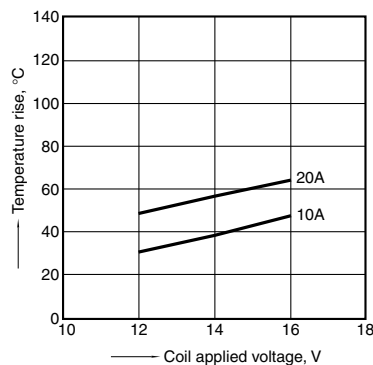

### 2. Ambient temperature and operating voltage range

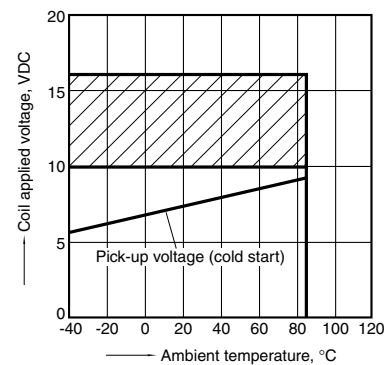

### 3. Distribution of pick-up and drop-out voltage

Sample: ACNM1112, 20pcs.

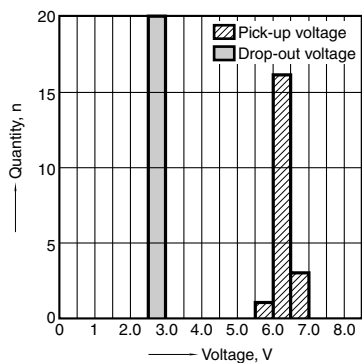

### 4. Distribution of operate and release time

Sample: ACNM1112, 20pcs.

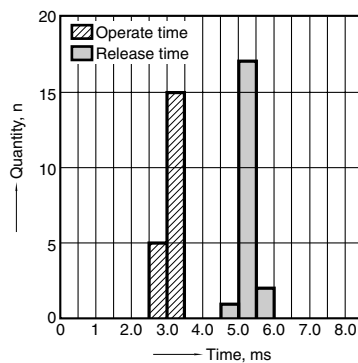

### 5-(1). Electrical life test (Resistive load)

Sample: ACNM1112, 3pcs.

Load: Resistive load (NO side: 30A 14V DC)

Operating frequency: (ON:OFF = 1s:1s)

Ambient temperature: Room temperature

Circuit:

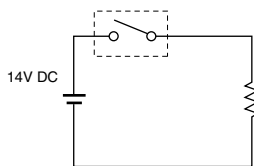

### Change of pick-up and drop-out voltage

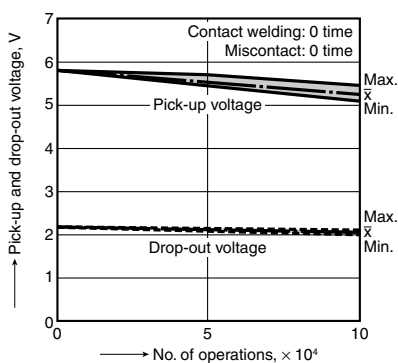

### Change of contact resistance

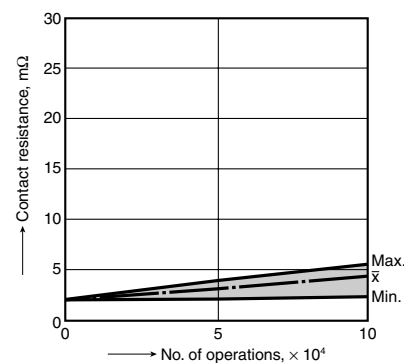

### 5-(2). Electrical life test (Motor load)

Sample: ACNM7112, 3pcs.

Load: inrush: 80A/steady: 16A, radiator fan actual load (motor free)

Switching frequency: (ON:OFF = 2s:6s)

Ambient temperature: 110°C 230°F

Circuit:

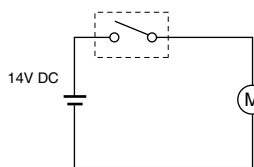

### Change of pick-up and drop-out voltage

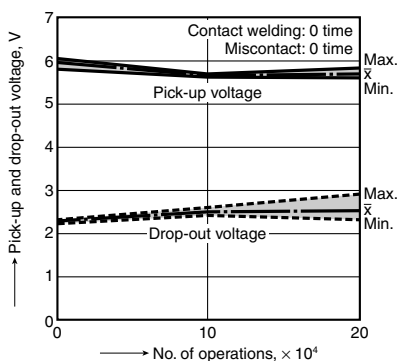

### Change of contact resistance

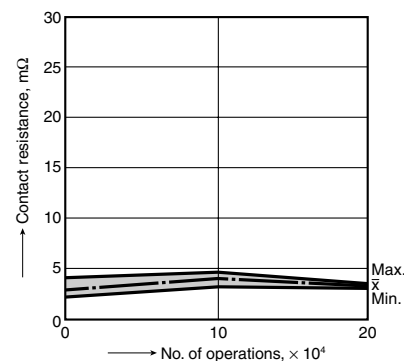

### 5-(3). Electrical life test (Lamp load)

Sample: ACNM3112, 3pcs.

Load: inrush: 84A/steady: 12A

Switching frequency: (ON:OFF = 1s:14s)

Ambient temperature: Room temperature

Circuit:

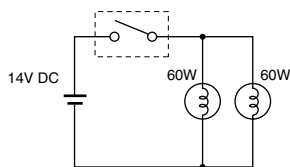

### Change of pick-up and drop-out voltage

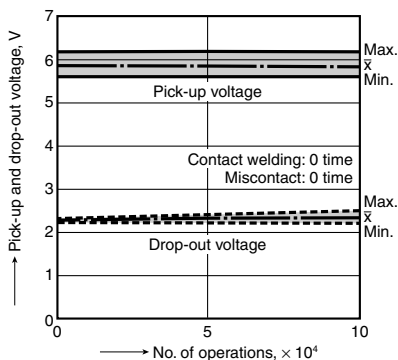

### Change of contact resistance

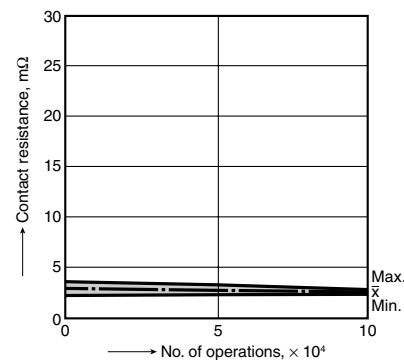

# CN-M (ACNM)

## DIMENSIONS (Unit: mm inch)

### 1. PC board terminal type



External dimensions

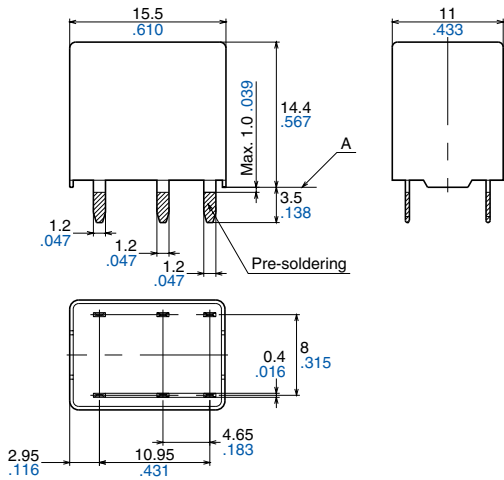

<b>Dimension:</b>	<b>General tolerance</b>
Max. 1mm .039 inch:	$\pm 0.1 \pm 0.04$
1 to 3mm .039 to .118 inch:	$\pm 0.2 \pm 0.08$
Min. 3mm .118 inch:	$\pm 0.3 \pm 0.12$

PC board pattern (Bottom view)

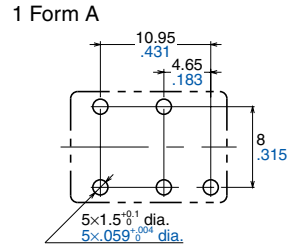

Schematic (Bottom view)

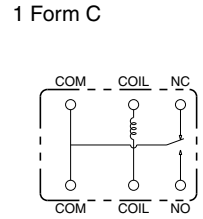
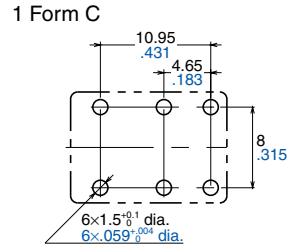
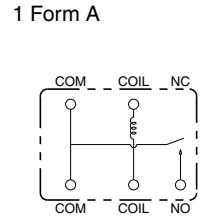

\* Dimensions (thickness and width) of terminal specified in this catalog is measured before pre-soldering. Intervals between terminals is measured at A surface level.

Tolerance:  $\pm 0.1 \pm 0.04$

### 2. Surface-mount terminal type



External dimensions

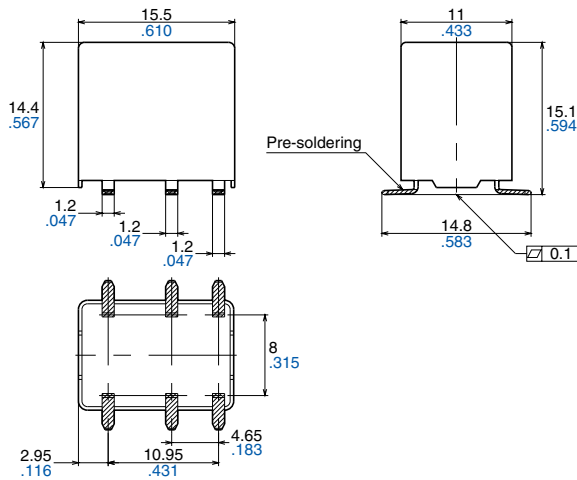

<b>Dimension:</b>	<b>General tolerance</b>
Max. 1mm .039 inch:	$\pm 0.1 \pm 0.04$
1 to 3mm .039 to .118 inch:	$\pm 0.2 \pm 0.08$
Min. 3mm .118 inch:	$\pm 0.3 \pm 0.12$

Recommended mounting pad (Top view)

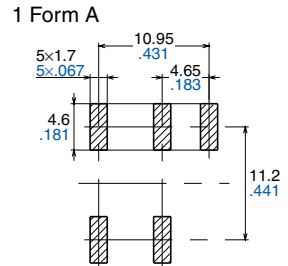

Schematic (Top view)

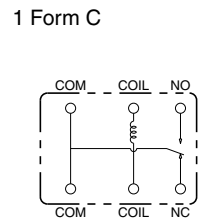
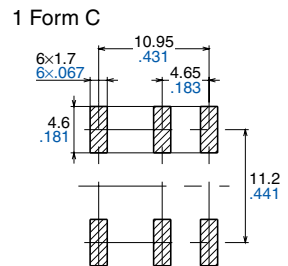
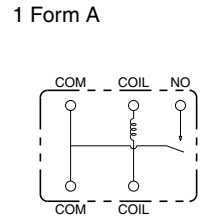

Tolerance:  $\pm 0.1 \pm 0.04$

## NOTES

### 1. Coil operating power

Pure DC current should be applied to the coil. The wave form should be rectangular. If it includes ripple, the ripple factor should be less than 5%. However, check it with the actual circuit since the characteristics may be slightly different.

### 2. Coil applied voltage

To ensure proper operation, the voltage applied to the coil should be the rated operating voltage of the coil. Also, be aware that the pick-up and drop-out voltages will fluctuate depending on the ambient temperature and operating conditions.

### 3. Cycle lifetime

Check this with the real device as it is affected by coil driving circuit, load type, activation frequency, activation phase, ambient conditions and other factors.

### 4. Soldering

When soldering the relays, ensure conformance with the conditions listed below.

#### 1) Automatic soldering

- Preheating: less than 100°C 212°F (solder target surface of PC board) for less than 120 sec

- Soldering: less than 260°C 500°F (solder temperature) for less than 5 sec (soldering time)

#### 2) Manual soldering

- Soldering tip temperature: less than 280 to 300°C 536 to 572°F
- Soldering iron: 30 to 60 W
- Soldering time: less than 5 sec

### 5. Usage, transport and storage conditions

1) Ambient temperature, humidity, and atmospheric pressure during usage, transport, and storage of the relay:

(1) Temperature:  
-40 to +85°C -40 to +185°F

(Standard type)  
-40 to +110°C -40 to +230°F  
(High heat-resistant type)

(2) Humidity: 2 to 85% RH  
(Avoid freezing and condensation.)

(3) Atmospheric pressure: 86 to 106 kPa  
The humidity range varies with the temperature. Use within the range indicated in the graph below.

(Temperature and humidity range for usage, transport, and storage)

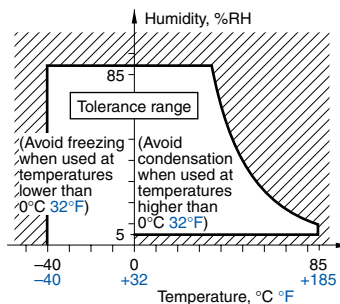
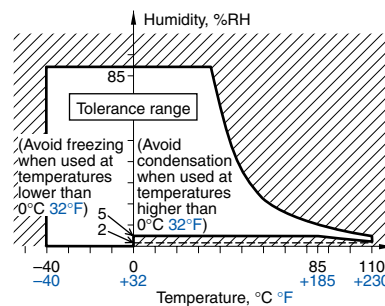

### 2) Condensation

Condensation forms when there is a sudden change in temperature under high temperature and high humidity conditions. Condensation will cause deterioration of the relay insulation.

### 3) Freezing

Condensation or other moisture may freeze on the relay when the temperatures is lower than 0°C 32°F. This causes problems such as sticking of movable parts or operational time lags.

### 4) Low temperature, low humidity environments

The plastic becomes brittle if the relay is exposed to a low temperature, low humidity environment for long periods of time.

### 6. Others

If the relay has been dropped, the appearance and characteristics should always be checked before use.

Компания «Океан Электроники» предлагает заключение долгосрочных отношений при поставках импортных электронных компонентов на взаимовыгодных условиях!

Наши преимущества:

- Поставка оригинальных импортных электронных компонентов напрямую с производств Америки, Европы и Азии, а так же с крупнейших складов мира;
- Широкая линейка поставок активных и пассивных импортных электронных компонентов (более 30 млн. наименований);
- Поставка сложных, дефицитных, либо снятых с производства позиций;
- Оперативные сроки поставки под заказ (от 5 рабочих дней);
- Экспресс доставка в любую точку России;
- Помощь Конструкторского Отдела и консультации квалифицированных инженеров;
- Техническая поддержка проекта, помощь в подборе аналогов, поставка прототипов;
- Поставка электронных компонентов под контролем ВП;
- Система менеджмента качества сертифицирована по Международному стандарту ISO 9001;
- При необходимости вся продукция военного и аэрокосмического назначения проходит испытания и сертификацию в лаборатории (по согласованию с заказчиком);
- Поставка специализированных компонентов военного и аэрокосмического уровня качества (Xilinx, Altera, Analog Devices, Intersil, Interpoint, Microsemi, Actel, Aeroflex, Peregrine, VPT, Syfer, Eurofarad, Texas Instruments, MS Kennedy, Miteq, Cobham, E2V, MA-COM, Hittite, Mini-Circuits, General Dynamics и др.);

Компания «Океан Электроники» является официальным дистрибьютором и эксклюзивным представителем в России одного из крупнейших производителей разъемов военного и аэрокосмического назначения «JONHON», а так же официальным дистрибьютором и эксклюзивным представителем в России производителя высокотехнологичных и надежных решений для передачи СВЧ сигналов «FORSTAR».



## JONHON

«JONHON» (основан в 1970 г.)

Разъемы специального, военного и аэрокосмического назначения:

(Применяются в военной, авиационной, аэрокосмической, морской, железнодорожной, горно- и нефтедобывающей отраслях промышленности)

«FORSTAR» (основан в 1998 г.)

ВЧ соединители, коаксиальные кабели, кабельные сборки и микроволновые компоненты:

(Применяются в телекоммуникациях гражданского и специального назначения, в средствах связи, РЛС, а так же военной, авиационной и аэрокосмической отраслях промышленности).



Телефон: 8 (812) 309-75-97 (многоканальный)

Факс: 8 (812) 320-03-32

Электронная почта: [ocean@oceanchips.ru](mailto:ocean@oceanchips.ru)

Web: <http://oceanchips.ru/>

Адрес: 198099, г. Санкт-Петербург, ул. Калинина, д. 2, корп. 4, лит. А