

# Optical Proximity Sensor ICs

## 1chip Optical Proximity + Ambient Light Sensor IC

**BH1772GLC**

No.12100EFT12

### ●Descriptions

BH1772GLC is the IC into which optical proximity sensor and digital ambient light sensor are unified. Proximity sensor part detects the human or object approach by reflection of infrared LED(IrLED) light. Ambient light sensor part can detect the wide range illuminance from the dark up to under direct sun light. The illuminant intensity of LCD display and keypad can be adjusted, so lower current consumption or higher visibility are possible.

### ●Features

- 1) Correspond to I<sup>2</sup>C bus interface ( f/s mode support )
- 2) Low Current by power down function
- 3) Correspond to 1.8V logic interface
- 4) ALS spectral responsibility is approximately human eye response ( Peak wavelength : typ. 550nm )
- 5) Correspond to wide range of light intensity ( 1-65535 lx range )
- 6) Rejecting 50Hz/60Hz light noise (ALS function)
- 7) Built in ambient light cancelation (Proximity sensor function)
- 8) Built in configurable IrLED current driver

### ●Applications

Mobile phone, DSC, Portable game, Camcorder, PDA, LCD display etc.

### ●Absolute Maximum Ratings ( Ta = 25°C )

| Parameter                      | Symbol                      | Ratings | Units |
|--------------------------------|-----------------------------|---------|-------|
| VCC, Supply Voltage            | Vccmax                      | 4.5     | V     |
| SDA,SCL,GNDNC Terminal Voltage | VSDAmax, VSCLmax, VGNDNCmax | 4.5     | V     |
| LEDC,INT Terminal Voltage      | VLEDCmax, VINTmax           | 7       | V     |
| Operating Temperature          | Topr                        | -40~85  | °C    |
| Storage Temperature            | Tstg                        | -40~100 | °C    |
| SDA, INT Sink Current          | I <sub>max</sub>            | 7       | mA    |
| Power Dissipation              | P <sub>d</sub>              | 250*    | mW    |

\* 70mm × 70mm × 1.6mm glass epoxy board. Decreasing rate is 3.33mW/°C for operating above Ta=25°C

### ●Operating Conditions

| Parameter             | Symbol | Ratings |      |      | Units |
|-----------------------|--------|---------|------|------|-------|
|                       |        | Min.    | Typ. | Max. |       |
| VCC Voltage           | Vcc    | 2.3     | 2.5  | 3.6  | V     |
| LEDC Terminal Voltage | Vledc  | 0.7     | 2.5  | 5.5  | V     |

●Electrical characteristics ( Vcc = 2.5V, Ta = 25°C, unless otherwise noted. )

| Parameter   | Symbol | Limits |      |      | Units | Conditions  |
|---|--------|--------|------|------|-------|---|
|   |        | Min.   | Typ. | Max. |       |   |
| Supply current for ALS  | Icc1   | —      | 90   | 180  | μA    | Ev = 100 lx ※1<br>Average current when ALS_CONTROL register(40h) = " 03h " and the other registers are default. |
| Supply current for PS   | Icc2   | —      | 90   | 180  | μA    | Average current when PS_CONTROL register(41h) = " 03h " and the other registers are default.                    |
| Supply current for PS during driving LED current                        | Icc3   | —      | 6.5  | 8.5  | mA    |   |
| Standby mode current  | Icc4   | —      | 0.8  | 1.5  | μA    | ALS & PS standby<br>No Input Light  |
| ALS measurement time  | tMALS  | —      | 100  | 125  | ms    | H-Resolution mode   |
| ALS measurement accuracy  | S/A    | 0.85   | 1.0  | 1.15 | Times | Sensor out / Actual Ix, Ev = 1000 lx ※1   |
| ALS dark ( 0 lx ) sensor out  | ALS0   | 0      | 0    | 2    | count | H-Resolution mode   |
| PS sensor out (No proximity object)                                     | PS0    | 0      | 0    | 30   | count | Ambient irradiance = 0μW/cm <sup>2</sup>  |
| PS sensor out (Irradiance by proximity object = 324μW/cm <sup>2</sup> ) | PS324u | 120    | 128  | 136  | count | Ambient irradiance = 0μW/cm <sup>2</sup>  |
| ILED pulse duration   | twILED | —      | 200  | 250  | μs    |   |
| PS measurement time   | tMPS   | —      | 10   | 12.5 | ms    |   |
| LEDC terminal sink current at LEDC terminal voltage = 1.3V              | ILEDc  | 18     | 20   | 22   | mA    | ILED register(42h) [2:0] = " 010 "  |
| INT output 'L' Voltage  | VINT   | 0      | —    | 0.4  | V     | IINT = 3mA  |
| SCL SDA input 'H' Voltage   | VIH    | 1.26   | —    | —    | V     |   |
| SCL SDA input 'L' Voltage   | VIL    | —      | —    | 0.54 | V     |   |
| SCL SDA input 'H'/'L' Current   | IHL    | -10    | —    | 10   | μA    |   |
| I <sup>2</sup> C SDA output 'L' Voltage                                 | VOL    | 0      | —    | 0.4  | V     | IOL = 3mA   |

※1 White LED is used as optical source

● I<sup>2</sup>C bus timing characteristics ( V<sub>CC</sub> = 2.5V, T<sub>a</sub> = 25°C, unless otherwise noted. )

| Parameter  | Symbol              | Limits |      |      | Units | Conditions |
|--|---------------------|--------|------|------|-------|------------|
|  |                     | Min.   | Typ. | Max. |       |            |
| I <sup>2</sup> C SCL Clock Frequency                                 | f <sub>SCL</sub>    | 0      | —    | 400  | kHz   |            |
| I <sup>2</sup> C Hold Time ( Repeated )<br>START Condition           | t <sub>HD;STA</sub> | 0.6    | —    | —    | μs    |            |
| I <sup>2</sup> C 'L' Period of the SCL Clock                         | t <sub>LOW</sub>    | 1.3    | —    | —    | μs    |            |
| I <sup>2</sup> C 'H' Period of the SCL Clock                         | t <sub>HIGH</sub>   | 0.6    | —    | —    | μs    |            |
| I <sup>2</sup> C Set up time<br>for a Repeated START Condition       | t <sub>SU;STA</sub> | 0.6    | —    | —    | μs    |            |
| I <sup>2</sup> C Data Hold Time                                      | t <sub>HD;DAT</sub> | 0      | —    | —    | μs    |            |
| I <sup>2</sup> C Data Setup Time                                     | t <sub>SU;DAT</sub> | 100    | —    | —    | ns    |            |
| I <sup>2</sup> C Set up Time<br>for STOP Condition                   | t <sub>SU;STO</sub> | 0.6    | —    | —    | μs    |            |
| I <sup>2</sup> C Bus Free Time between<br>a STOP and START Condition | t <sub>BUF</sub>    | 1.3    | —    | —    | μs    |            |
| I <sup>2</sup> C Data Valid Time                                     | t <sub>VD;DAT</sub> | —      | —    | 0.9  | μs    |            |
| I <sup>2</sup> C Data Valid Acknowledge Time                         | t <sub>VD;ACK</sub> | —      | —    | 0.9  | μs    |            |

● Package outlines

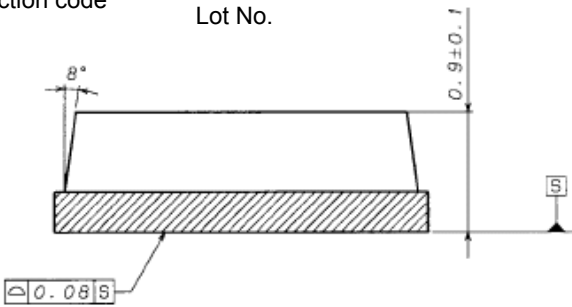
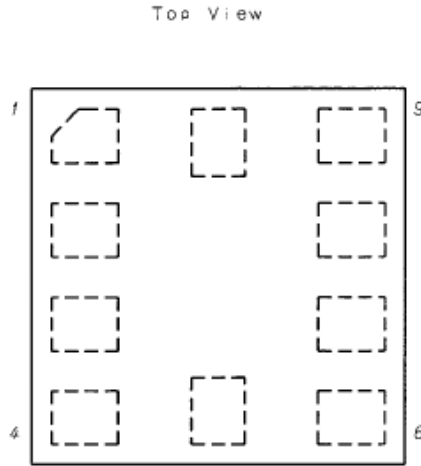
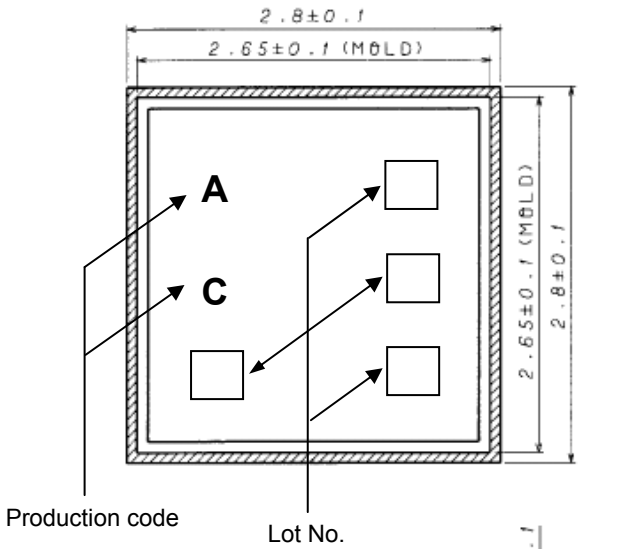

Bottom View

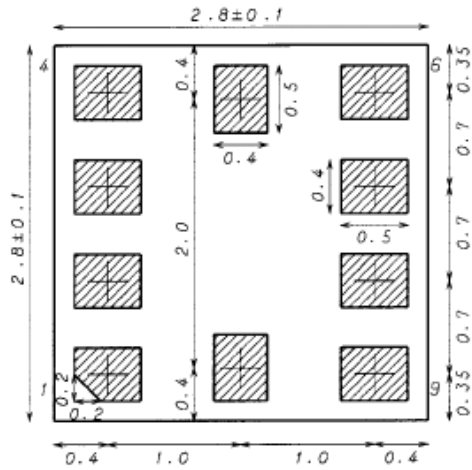

WLGA010V28

(UNIT: mm)

Drawing No. EX812-6001

●Reference Data

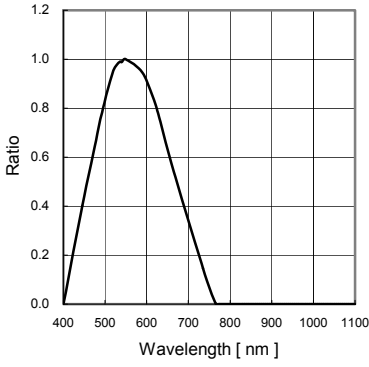

Fig.1 ALS Spectral Response

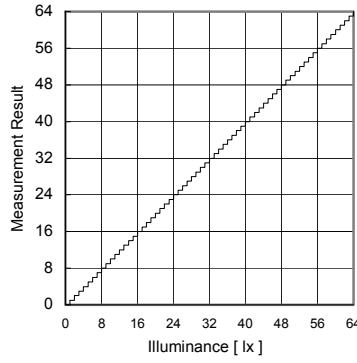

Fig.2 Illuminance - ALS Measurement Result

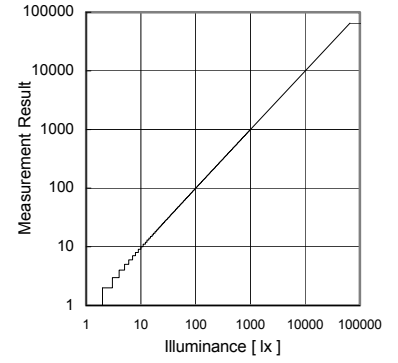

Fig.3 Illuminance - ALS Measurement Result 2

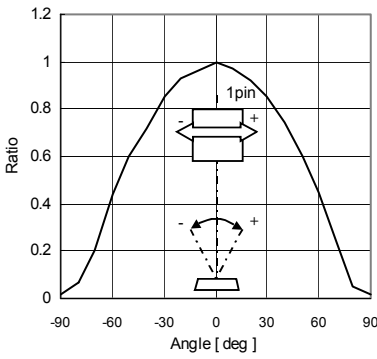

Fig.4 ALS Directional Characteristics 1

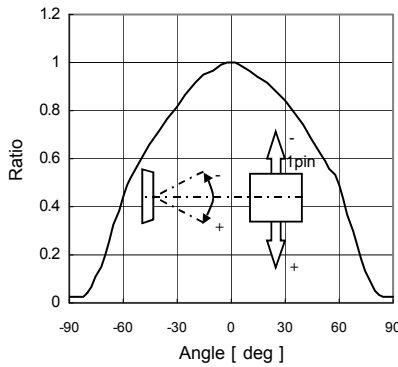

Fig.5 ALS Directional Characteristics 2

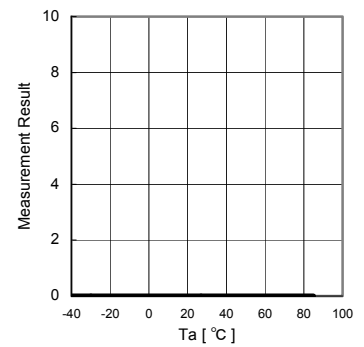

Fig.6 ALS Dark Response

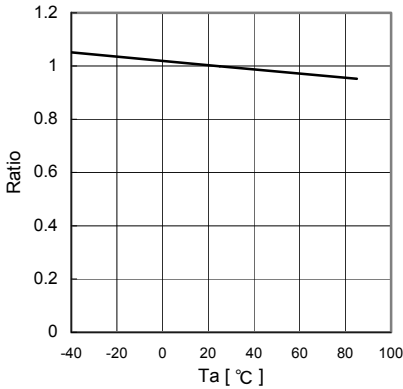

Fig.7 ALS Measurement Accuracy Temperature Dependency

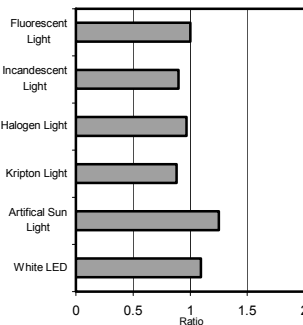

Fig.8 ALS Light Source Dependency (Fluorescent Light is set to '1')

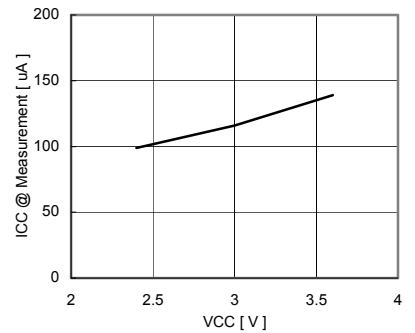

Fig.9 VCC - ICC (During ALS measurement)

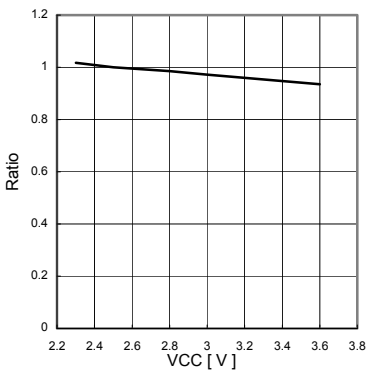

Fig.10 ALS Measurement Result VCC Dependency

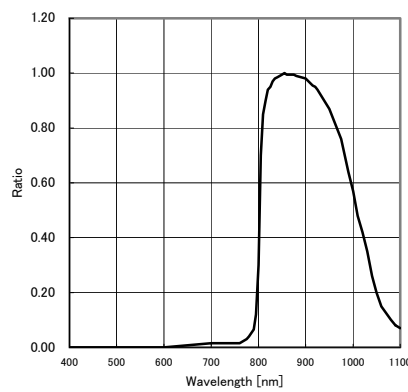

Fig.11 PS Spectral Response

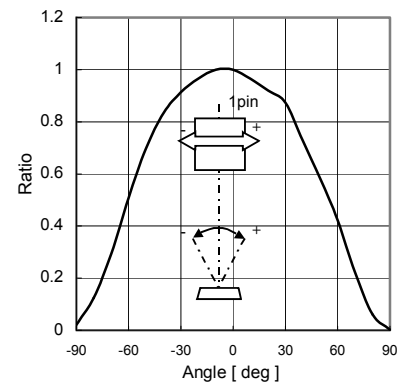

Fig.12 PS Directional Characteristics 1

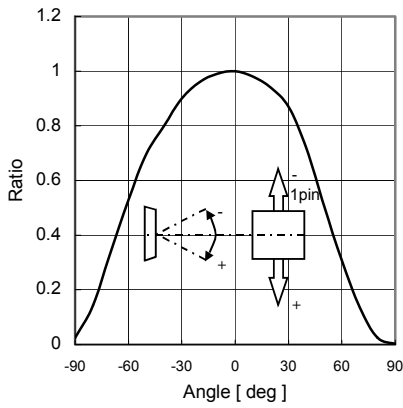

Fig.13 PS Directional Characteristics 2

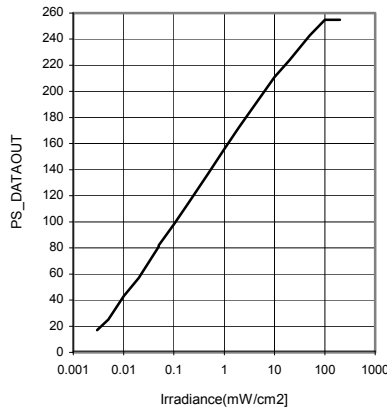

Fig.14 Irradiance – PS\_DATAOUT

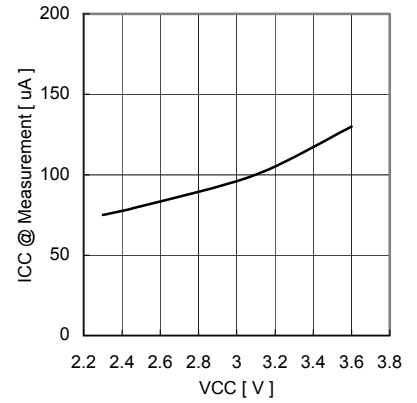

Fig.15 VCC - ICC (During PS measurement)

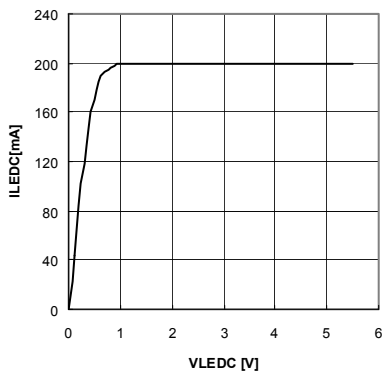

Fig.16 VLEDC – ILEDC@ ILED is set 200mA by ILED register

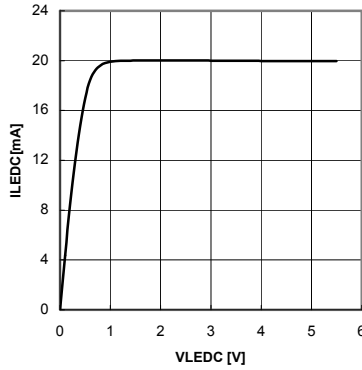

Fig.17 VLEDC – ILEDC@ ILED is set 20mA by ILED register

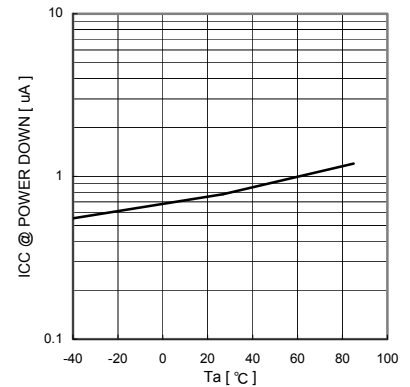

Fig.18 VCC – ICC@0 Lx (POWER DOWN)

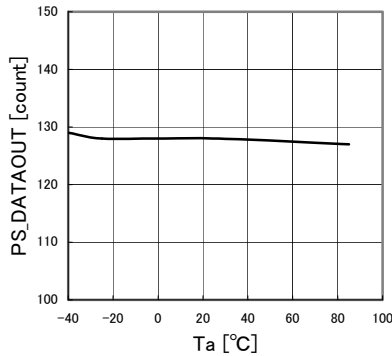

Fig.19 PS sensor out Temperature Dependency (Irradiance by Proximity object = 324μW/cm²)

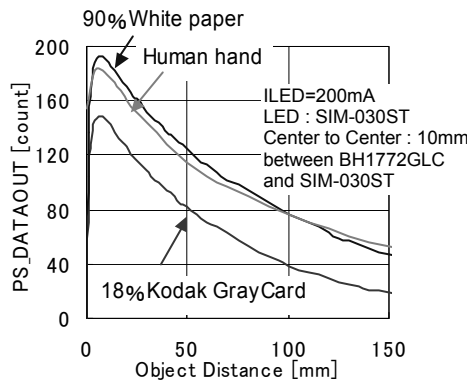

Fig.20 Object Distance – PS\_DATAOUT of different reflector

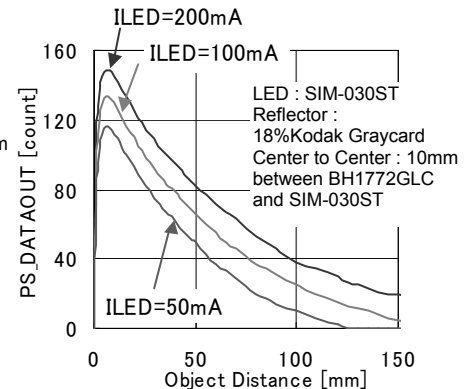

Fig.21 Object Distance – PS\_DATAOUT of different ILED

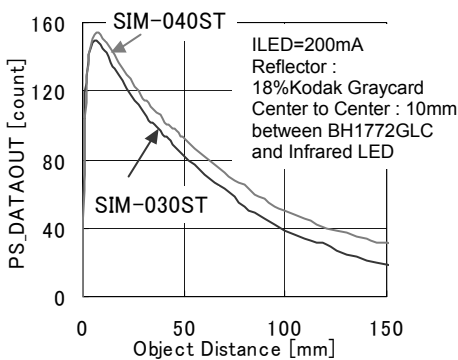

Fig.22 Object Distance – PS\_DATAOUT of different Infrared LED

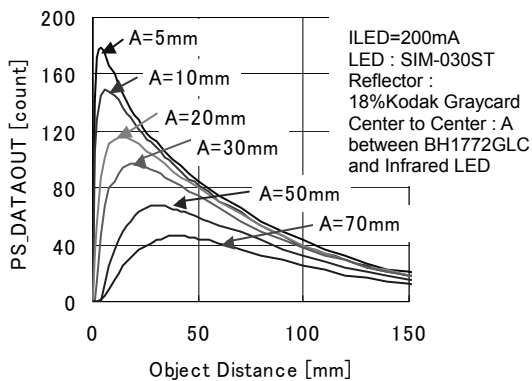

Fig.23 Object Distance – PS\_DATAOUT of different distance between BH1772GLC and SIM-030ST

● I<sup>2</sup>C bus communication

1) Slave address "0111000"

2) Main write format

1. Case of "Indicate register address"



2. Case of "write to data register after indicating register address"



BH1772GLC continues to write data with address increments until master issues stop condition.  
Write cycle is 40h - 41h - 42h - 43h - 44h - 45h - 46h - 52h ..... 5Dh - 5Eh - 40h .....

Ex ) If register address field is 45h, then BH1772GLC writes data like seeing in below.  
45h - 46h -52h ..... 5Dh - 5Eh - 40h.....It is continued until master issues stop condition.

3) Main read format

1. Case of read data after indicate register address and read data ( Master issues restart condition )

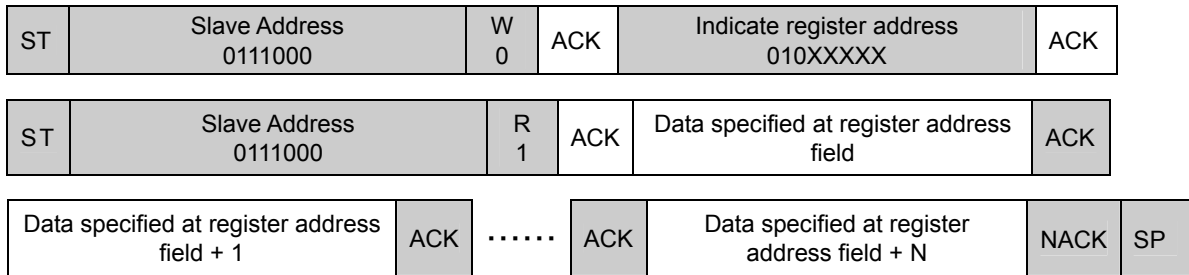

2. Case of read data after selecting register address

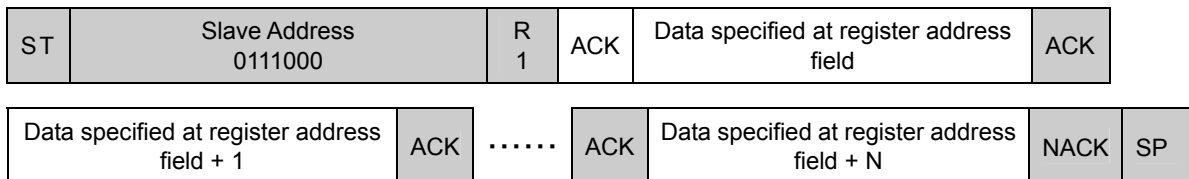

BH1772GLC outputs data from specified address field until master issues stop condition.  
Read cycle is 40h - 41h - 42h - 43h - 44h - 45h - 46h - 4Ah ..... 5Dh - 5Eh - 40h .....

Ex ) If register address field is 4Ch, then BH1772GLC outputs data like seeing in below.  
4Ch - 4Dh -4Eh ..... 5Dh - 5Eh - 40h.....It is continued until master issues stop condition.



- ※ BH1772GLC operates as I<sup>2</sup>C bus slave device.
- ※ Please refer formality I<sup>2</sup>C bus specification of NXP semiconductors

## ●Block diagram and block explanation

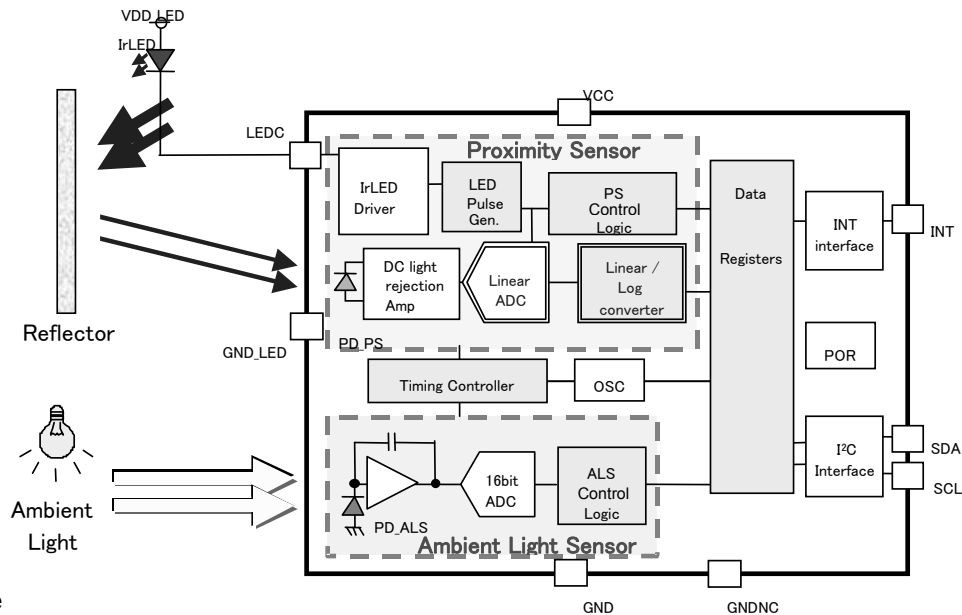

- I<sup>2</sup>C Interface  
I<sup>2</sup>C bus interface. 1.8V logic interface is supported.
- POR  
Power on reset function.
- OSC  
Internal oscillator.
- Timing controller  
Internal management block for proximity sensor and ambient light sensor.
- INT interface  
INT terminal control block. Details are on Page 13 - 14
- DATA registers  
Register for storage of measurement results or commands. Details are on Page 15.
- PS control logic  
This block controls proximity sensor analog block
- LED Pulse Gen  
LED current generator. LED current value is configurable by ILED( 42h ) register.
- IrLED Driver  
IrLED driver block.
- PD\_ALS  
Photo diode for ambient light sensor. Peak wavelength is approximately 550nm.
- 16bit ADC  
AD converter for ALS.
- ALS control logic  
This block controls ambient light sensor analog block.
- PD\_PS  
Photo diode for proximity sensor. Peak wavelength is approximately 850nm.
- DC light rejection Amp  
DC light is rejected in this block. And generated Infrared pulse is passed to linear ADC block.
- Linear ADC  
AD converter for proximity sensor. Detection range is very wide (  $1\mu\text{W}/\text{cm}^2$  -  $100\text{mW}/\text{cm}^2$  ).
- Linear/Log converter  
Linear to logarithm converter for proximity sensor. Output data is 8bit.  
PS irradiance calculation example is on Page 23.



●Example of application circuit diagram

If you do not use the INT pin, please connect to GND or opening (non connect).  
Regarding NC1 and NC2, please connect to VDD\_LED or open (non connect).

1) Standard application circuit example

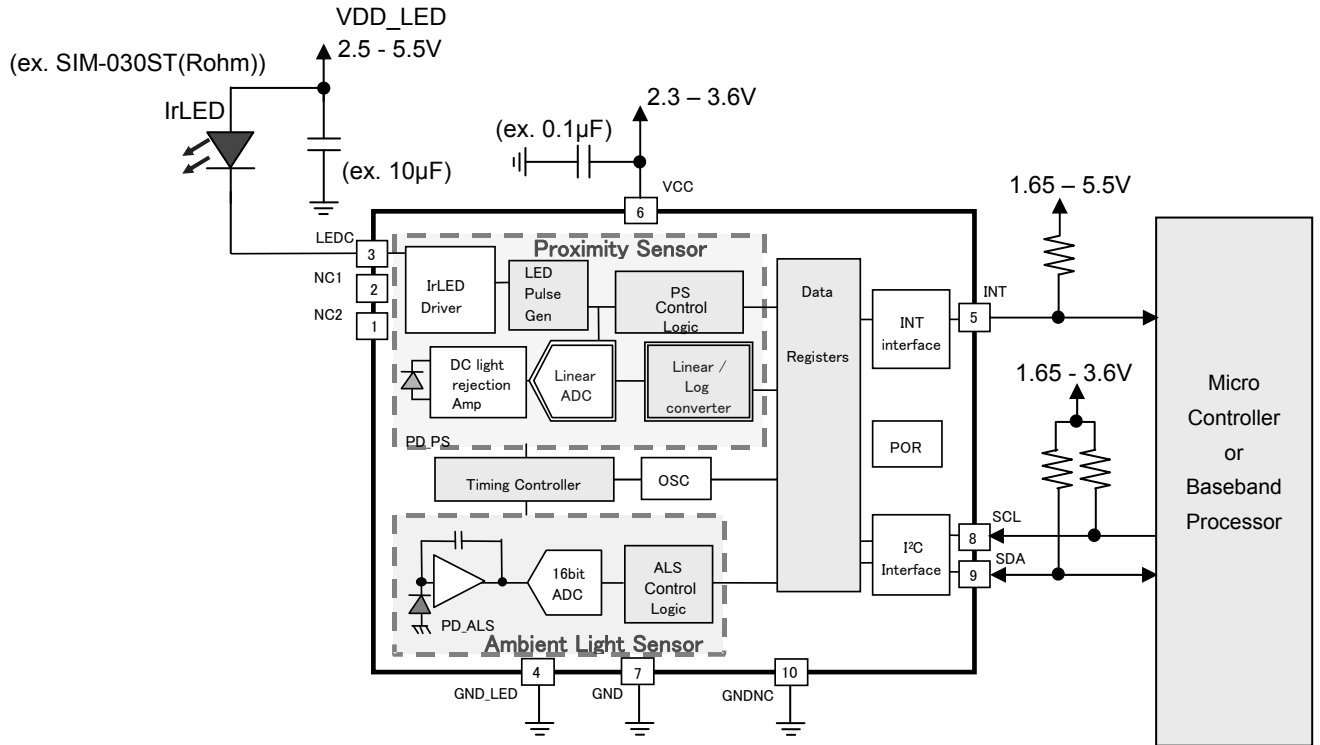

2) In case of extending proximity sensor detection distance

BH1772GLC can drive maximum 200mA(Typ) current. By adding simple external circuit, it is possible to increase IrLED current and to extend detection distance. In case of driving large current for IrLED, note that the current value must not be over the absolute maximum rating for IrLED.

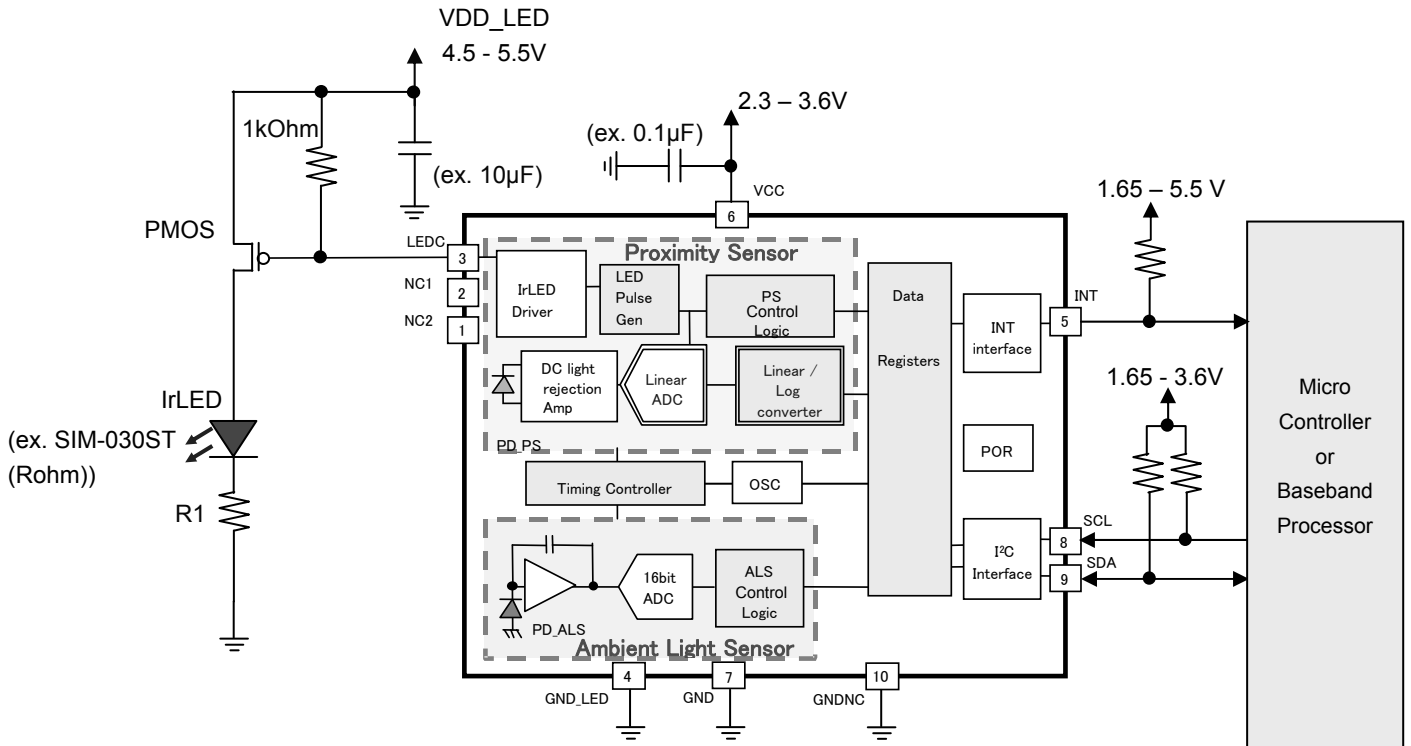

## ● Terminal description

| PIN No. | Terminal Name | Equivalent Circuit | Function  |
|---------|---------------|--------------------|---|
| 1       | NC1           |                    | Terminal for internal test.<br>Non connect or pull up to VDD_LED<br>( external IrLED anode terminal )   |
| 2       | NC2           |                    | Terminal for internal test.<br>Non connect or pull up to VDD_LED<br>( external IrLED anode terminal )   |
| 3       | LEDC          |                    | Nch open drain LED current output terminal. LED current and emitting interval is defined by internal register. Register value is possible to configure by I <sup>2</sup> C bus. |
| 4       | GND_LED       |                    | GND terminal for LED driver   |
| 5       | INT           |                    | Nch open drain output.<br>Interrupt setting is defined by internal register.<br>Register value is possible to configure by I <sup>2</sup> C bus.                                |
| 6       | VCC           |                    | Power supply terminal   |
| 7       | GND           |                    | GND terminal  |
| 8       | SCL           |                    | I <sup>2</sup> C bus Interface SCL terminal   |
| 9       | SDA           |                    | I <sup>2</sup> C bus Interface SDA terminal   |
| 10      | GNDNC         |                    | Non connect or pull down to GND   |

### ● Proximity sensor measurement sequence

The below figure shows proximity sensor measurement sequence. First PS measurement is triggered by I<sup>2</sup>C bus master writes measurement command to PS\_CONTROL register ( 41h ).

#### 1. Forced mode

PS measurement is done only 1time and PS trigger bit ( 44h<0> ) is overwritten from 'H' to 'L' after PS measurement complete. PS measurement is re-started by master writes PS trigger bit to 'H'.

#### 2. Stand alone mode

PS measurement is continuously done until master select the other mode. Measurement interval is defined at PS\_MEAS\_RATE register ( 45h ).

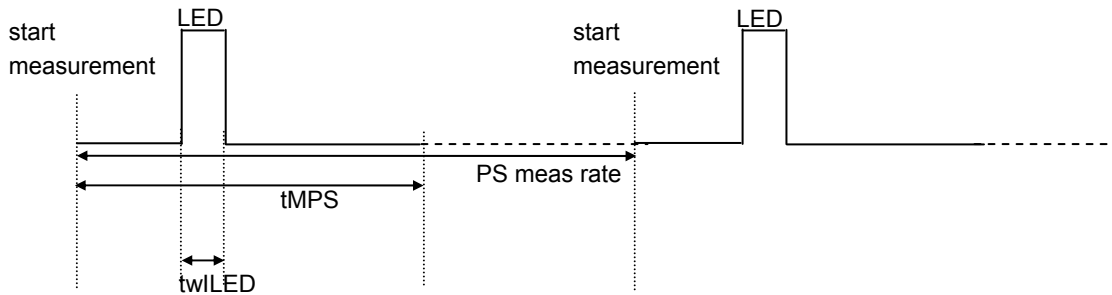

twLED : LED current pulse duration, please refer P2 ( Electrical Characteristics ).

tMPS : Proximity sensor measurement time, please refer P2 ( Electrical Characteristics ). Measurement result is generated in this term.

PS meas rate : In case of stand alone mode, It is defined at PS\_MEAS\_RATE register ( 45h ). In case of forced mode, it means the term until overwriting PS trigger bit to 'H'.

### ● Ambient light sensor measurement sequence

The below figure shows ambient light sensor measurement sequence. First ALS measurement is triggered by I<sup>2</sup>C bus master writing measurement command to ALS\_CONTROL register ( 40h ).

#### 1. Forced mode

ALS measurement is done only 1time and ALS trigger bit( 44h<1> ) is overwritten from 'H' to 'L' after ALS measurement is completed. ALS measurement is re-started by master writes ALS trigger bit to 'H'.

#### 2. Stand alone mode

ALS measurement is continuously done until master select the other mode. Measurement interval is defined at ALS\_MEAS\_RATE register ( 46h ). If ALS rate disable bit ( 46h<7> ) is 'H', there is no interval between measurement.

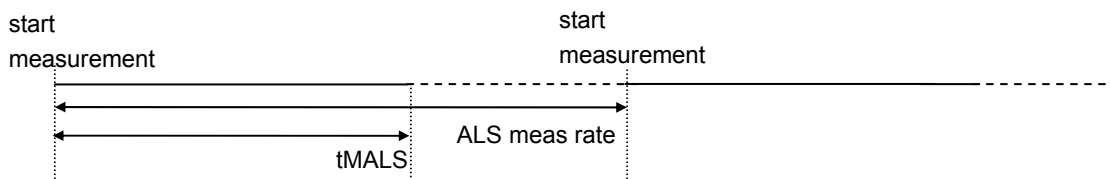

tMALS : Ambient light sensor measurement time, please refer P2 ( Electrical Characteristics ). Measurement result is generated in this term.

ALS meas rate: In case of stand alone mode, It is defined at ALS\_MEAS\_RATE register ( 46h ). In case of forced mode, it means the term until overwriting ALS trigger bit to 'H'.

●Interrupt function

Interrupt function compares ALS or PS measurement result to preset interrupt threshold level. PS uses one threshold level or two threshold level ( in hysteresis mode ) and ALS uses two threshold level (upper and lower ).

Interrupt status is monitored by INT pin or ALS\_PS\_STATUS register ( 4Eh ) and Interrupt function is able to be controlled by INTERRUPT register ( 52h ). Interrupt threshold is defined at ALS\_TH\_UP and ALS\_TH\_LOW and PS\_TH\_H and PS\_TH\_L registers ( 53h, 56 - 59h, 5Ch ). PS\_TH\_L registers is effective when PS hysteresis bit ( 52h<4> ) is 'H'.

Interrupt persistence function is defined at PERSISTENCE register ( 5Bh ).

INT pin is Nch open drain terminal so this terminal should be pull-up to some kind of voltage source by an external resistor. Maximum sink current rating of this terminal is 7mA.

There are two output modes about interrupt function ( latched mode and unlatched mode ).

In case of using ALS and PS interrupt functions at the same time, latch mode is recommended.

INT terminal is high impedance when VCC is supplied.

INT terminal becomes inactive by setting INTERRUPT register (52h)[1:0] to "00". ( It is not worked during power down mode. Power down mode means ALS\_CONTROL(40h)<1>='0' and PS\_CONTROL(41h)<1> = '0'.)

INT terminal keeps just previous state which power down command is sent. So to set INT terminal to high impedance is recommended. VCC current(approximately 25µA at VCC=2.5V) is consumed during INT terminal is 'L'. There are two method to set INT terminal to high impedance.

- 1) Send software reset command. (Write 'H' to ALS\_CONTROL(40h)<2>. Software reset is also worked during power down. All registers are initialized by software reset command.)
- 2) Write "000" to INTERRUPT register(52h)<2:0>.

ex1) In case of using only PS 'H' threshold ( INTERRUPT register 52h<4> : '0' )

In case of unlatch mode if the measurement value exceeds the PS interrupt threshold 'H' value, the interrupt becomes active. And if the measurement value goes below the threshold, the interrupt becomes inactive.

In case of latch mode once the interrupt becomes active, it keeps the status until end of measurement after INTERRUPT register is read.

In case of persistence function is set to active, if the interrupt is inactive, it keeps inactive status until the measurement value is beyond the threshold 'H' value continuously. If the interrupt is active, it keeps active status until the measurement value is below threshold 'H' value continuously or until end of measurement after INTERRUPT register is read.

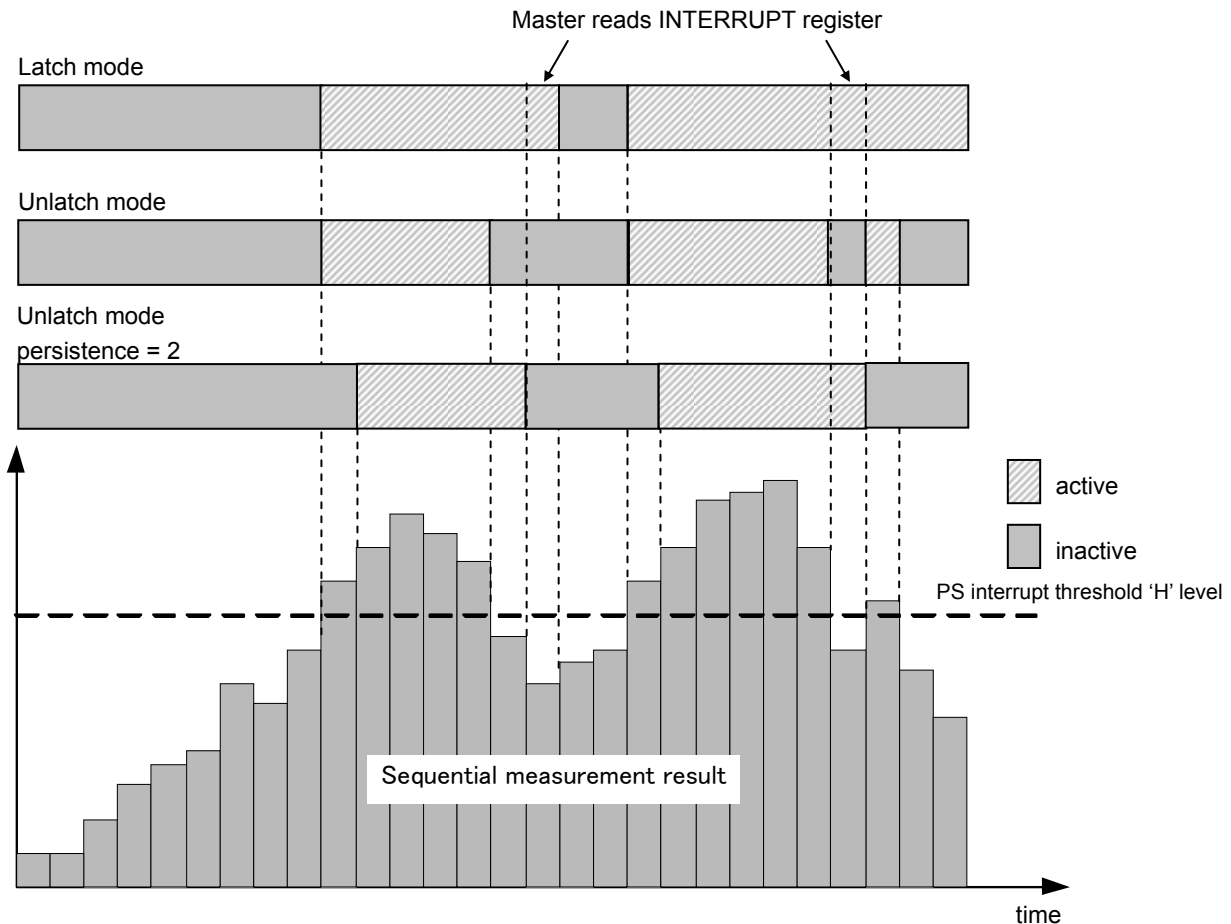

ex2 ) In case of using PS 'H/L' threshold ( INTERRUPT register 52h<4> : '1' )

In case of unlatch mode if the measurement value exceeds the PS interrupt threshold 'H' value, the interrupt becomes active. And if the measurement value goes below the threshold 'L' value, the interrupt becomes inactive.

In case of latch mode once the interrupt becomes active, it keeps the status until end of measurement after INTERRUPT register is read.

In case of persistence function is set to active, if the interrupt is inactive, it keeps inactive status until the measurement value is beyond the threshold 'H' value continuously. If the interrupt is active, it keeps active status until the measurement value is below threshold 'L' value continuously or until end of measurement after INTERRUPT register is read.

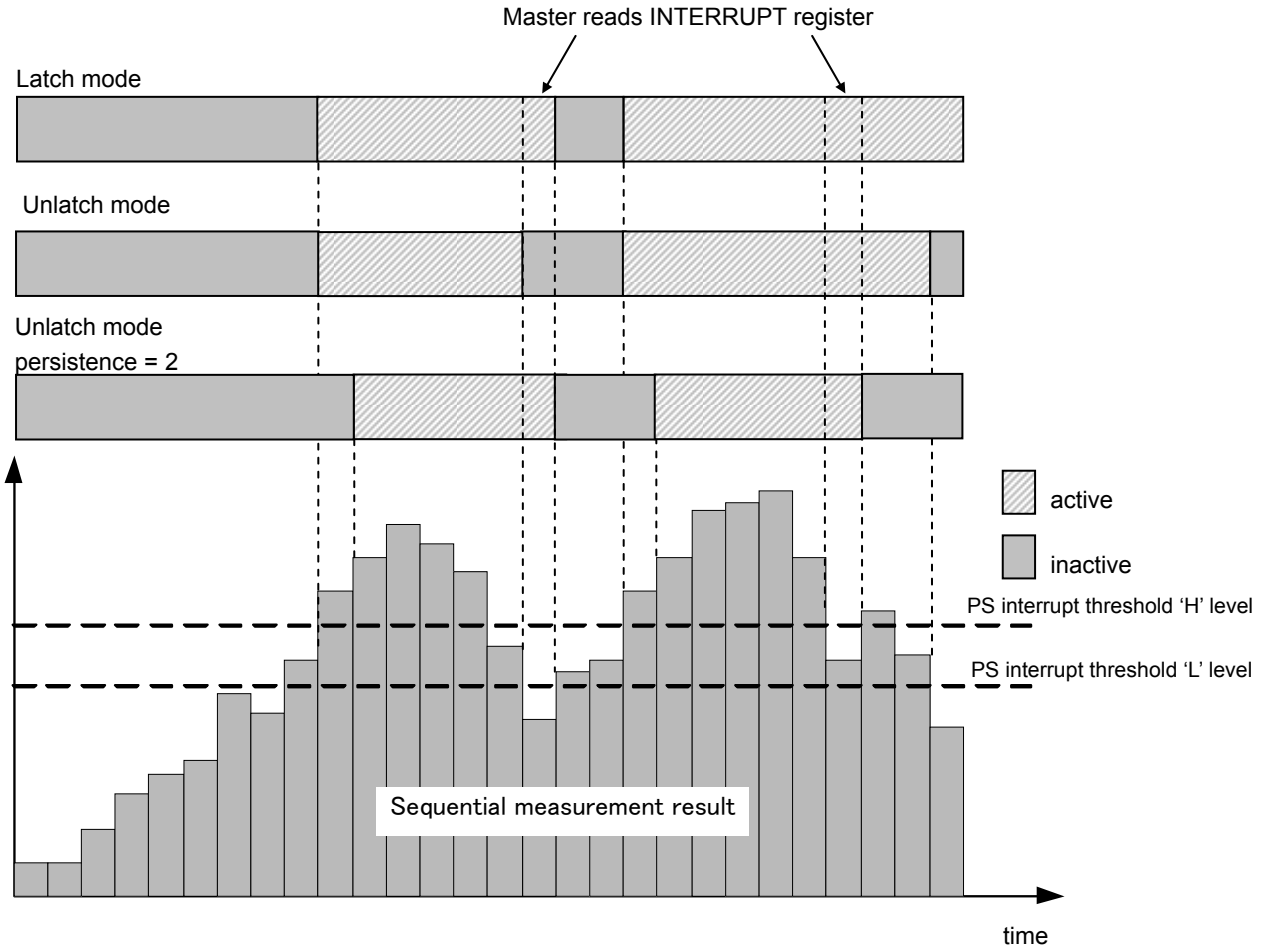

ex3 ) Ambient light sensor interrupt function

In case of unlatch mode if the measurement value is within the range set by ALS interrupt threshold 'H' and 'L' value, the interrupt becomes inactive. And if the measurement value is out of the range set by threshold 'H' and 'L' value, the interrupt becomes active.

In case of latch mode once the interrupt becomes active, it keeps the status until end of measurement after INTERRUPT register is read.

In case that persistence function is set to active, if the interrupt is inactive, it keeps inactive status until the measurement value is continuously out of the range set by threshold 'H' and 'L' value. If the interrupt is active, it keeps active status until the measurement value is continuously within the range set by threshold 'H' and 'L' value or until end of measurement after INTERRUPT register is read.

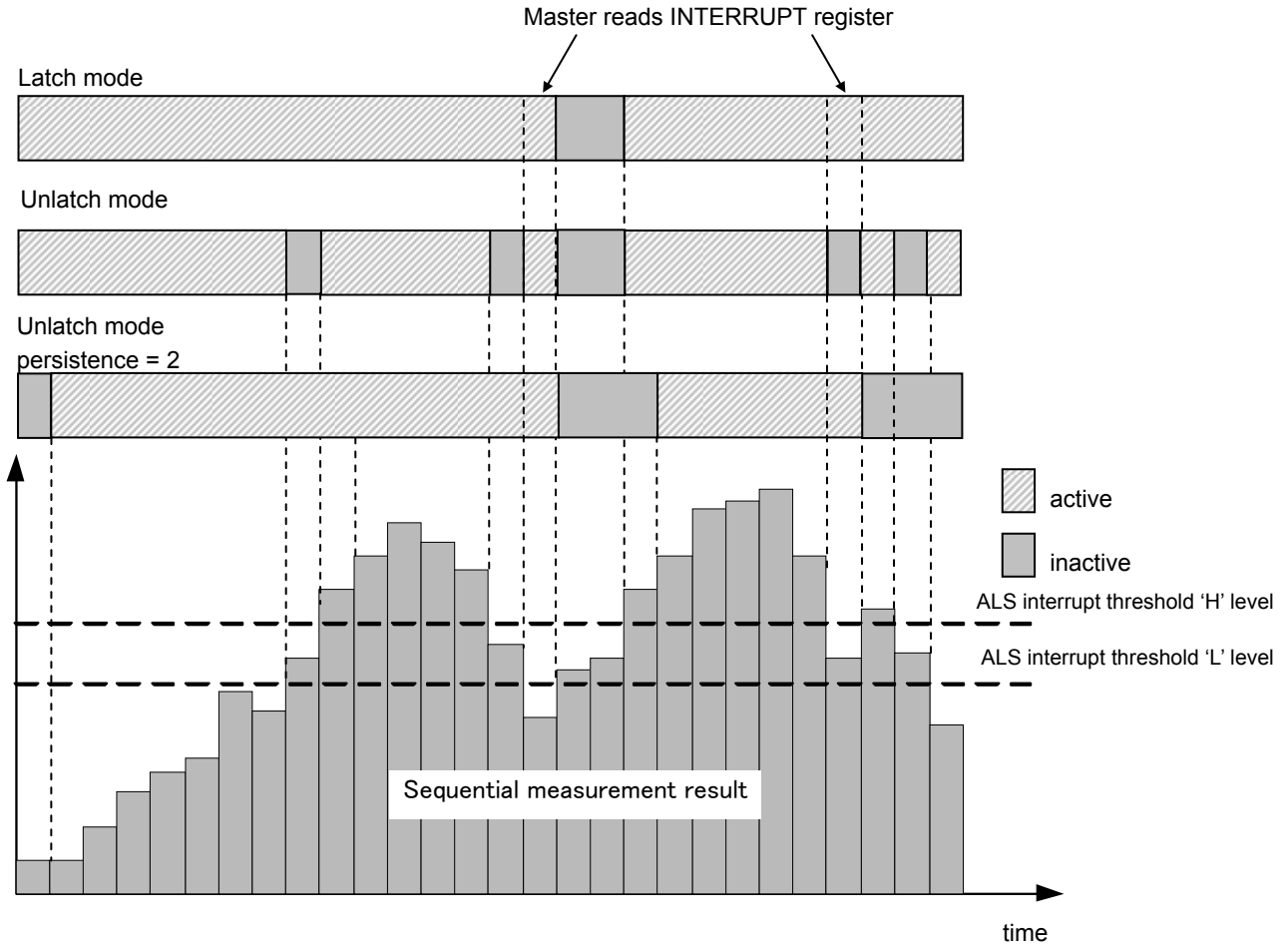

## ●Command set

| Address | Type | Register name       | Register function                       |
|---------|------|---------------------|---|
| 40h     | RW   | ALS_CONTROL         | ALS operation mode control and SW reset |
| 41h     | RW   | PS_CONTROL          | PS operation mode control               |
| 42h     | RW   | I_LED               | LED current setting                     |
| 43h     | RW   | Reserved register 1 | -                                       |
| 44h     | RW   | ALS_PS_MEAS         | Forced mode trigger                     |
| 45h     | RW   | PS_MEAS_RATE        | PS measurement rate                     |
| 46h     | RW   | ALS_MEAS_RATE       | ALS measurement rate                    |
| 4Ah     | R    | Reserved register 2 | -                                       |
| 4Bh     | R    | Reserved register 3 | -                                       |
| 4Ch     | R    | ALS_DATA_0          | ALS data (Low Byte)                     |
| 4Dh     | R    | ALS_DATA_1          | ALS data (High Byte)                    |
| 4Eh     | R    | ALS_PS_STATUS       | Measurement data and interrupt status   |
| 4Fh     | R    | PS_DATA             | PS data                                 |
| 50h     | R    | Reserved register 4 | -                                       |
| 51h     | R    | Reserved register 5 | -                                       |
| 52h     | RW   | INTERRUPT           | Interrupt setting                       |
| 53h     | RW   | PS_TH_H             | PS interrupt H threshold                |
| 54h     | RW   | Reserved register 6 | -                                       |
| 55h     | RW   | Reserved register 7 | -                                       |
| 56h     | RW   | ALS_TH_UP_0         | ALS upper threshold low byte            |
| 57h     | RW   | ALS_TH_UP_1         | ALS upper threshold high byte           |
| 58h     | RW   | ALS_TH_LOW_0        | ALS lower threshold low byte            |
| 59h     | RW   | ALS_TH_LOW_1        | ALS lower threshold high byte           |
| 5Ah     | RW   | ALS_SENSITIVITY     | ALS sensitivity setting                 |
| 5Bh     | RW   | PERSISTENCE         | INT pin INTERRUPT persistence setting   |
| 5Ch     | RW   | PS_TH_L             | PS interrupt L threshold                |
| 5Dh     | RW   | Reserved register 8 | -                                       |
| 5Eh     | RW   | Reserved register 9 | -                                       |

OALS\_CONTROL ( 40h )

|     |     |     |     |                |          |          |   |
|-----|-----|-----|-----|----------------|----------|----------|---|
| 7   | 6   | 5   | 4   | 3              | 2        | 1        | 0 |
| RES | RES | RES | RES | ALS Resolution | SW Reset | ALS mode |   |

default value 00h

| Field          | Bit   | Type | Description  |
|----------------|-------|------|--|
| RES            | 7 : 4 | RW   | Write "0000"   |
| ALS Resolution | 3     | RW   | 0 : H-Resolution mode, 1 lx step output<br>1 : M-Resolution mode, 4 lx step output |
| SW reset       | 2     | RW   | 0 : initial reset is not started<br>1 : initial reset is started                   |
| ALS mode       | 1 : 0 | RW   | 00 : Standby mode<br>01 : Don't use.<br>10 : Forced mode<br>11 : Stand alone mode  |

OPS\_CONTROL ( 41h )

|   |   |   |   |   |   |         |   |
|---|---|---|---|---|---|---------|---|
| 7 | 6 | 5 | 4 | 3 | 2 | 1       | 0 |
| X | X | X | X | X | X | PS mode |   |

default value 00h

| Field   | Bit   | Type | Description   |
|---------|-------|------|---|
| NA      | 7 : 2 | -    | Ignored   |
| PS mode | 1 : 0 | RW   | 00 : Standby mode<br>01 : Don't use.<br>10 : Forced mode<br>11 : Stand alone mode |

OI\_LED ( 42h )

|          |   |   |   |   |             |   |   |
|----------|---|---|---|---|-------------|---|---|
| 7        | 6 | 5 | 4 | 3 | 2           | 1 | 0 |
| Reserved |   |   |   |   | LED current |   |   |

default value 1Bh

| Field       | Bit   | Type | Description  |
|-------------|-------|------|--|
| Reserved    | 7 : 3 | RW   | write "00011"  |
| LED current | 2 : 0 | RW   | 000 : 5mA<br>001 : 10mA<br>010 : 20mA<br>011 : 50mA<br>100 : 100mA<br>101 : 150mA<br>11X : 200mA |

OReserved register 1 ( 43h )

|   |   |   |   |   |          |   |   |
|---|---|---|---|---|----------|---|---|
| 7 | 6 | 5 | 4 | 3 | 2        | 1 | 0 |
| X | X | X | X | X | Reserved |   |   |

default value 03h

| Field    | Bit   | Type | Description |
|----------|-------|------|-------------|
| NA       | 7 : 3 | -    | Ignored     |
| Reserved | 2 : 0 | RW   | 000 : 5mA   |



## OALS\_PS\_MEAS ( 44h )

|   |   |   |   |   |   |             |            |
|---|---|---|---|---|---|-------------|------------|
| 7 | 6 | 5 | 4 | 3 | 2 | 1           | 0          |
| X | X | X | X | X | X | ALS trigger | PS trigger |

default value 00h

| Field       | Bit   | Type | Description  |
|-------------|-------|------|--|
| NA          | 7 : 2 | -    | Ignored  |
| ALS trigger | 1     | RW   | 0 : Ignored<br>1 : Start ALS measurement at force mode <sup>*2</sup> |
| PS trigger  | 0     | RW   | 0 : Ignored<br>1 : Start PS measurement at force mode <sup>*2</sup>  |

<sup>\*2</sup> Even if trigger is set during measurement, the measurement doesn't restart. The measurement will start, in case that it is set to forced mode by ALS\_CONTROL register (40h) or PS\_CONTROL register (41h) and is not during measurement.

## OPS\_MEAS\_RATE ( 45h )

|   |   |   |   |              |   |   |   |
|---|---|---|---|--------------|---|---|---|
| 7 | 6 | 5 | 4 | 3            | 2 | 1 | 0 |
| X | X | X | X | PS meas rate |   |   |   |

default value 05h

| Field        | Bit   | Type | Description   |
|--------------|-------|------|---|
| NA           | 7 : 4 | -    | Ignored   |
| PS meas rate | 3 : 0 | RW   | 0000 : 10ms<br>0001 : 20ms<br>0010 : 30ms<br>0011 : 50ms<br>0100 : 70ms<br>0101 : 100ms<br>0110 : 200ms<br>0111 : 500ms<br>1000 : 1000ms<br>1001 : 2000ms<br>101X : 2000ms<br>11XX : 2000ms |

## OALS\_MEAS\_RATE ( 46h )

|                  |   |   |   |   |               |   |   |
|------------------|---|---|---|---|---------------|---|---|
| 7                | 6 | 5 | 4 | 3 | 2             | 1 | 0 |
| ALS rate disable | X | X | X | X | ALS meas rate |   |   |

default value 02h

| Field            | Bit   | Type | Description  |
|------------------|-------|------|--|
| ALS rate disable | 7     | RW   | 0 : ALS meas rate( 46h<2:0> ) is active<br>1 : ALS meas rate( 46h<2:0> ) is inactive |
| NA               | 6 : 3 | -    | Ignored  |
| ALS meas rate    | 2 : 0 | RW   | 000 : 100ms<br>001 : 200ms<br>010 : 500ms<br>011 : 1000ms<br>1XX : 2000ms            |

## OReserved register 2 ( 4Ah )

|   |   |   |   |   |   |   |   |
|---|---|---|---|---|---|---|---|
| 7 | 6 | 5 | 4 | 3 | 2 | 1 | 0 |
| X | X | X | X | X | X | X | X |

default value 93h

| Field | Bit   | Type | Description |
|-------|-------|------|-------------|
| NA    | 7 : 0 | R    | Reserved    |

## OReserved register 3 ( 4Bh )

|   |   |   |   |   |   |   |   |
|---|---|---|---|---|---|---|---|
| 7 | 6 | 5 | 4 | 3 | 2 | 1 | 0 |
| X | X | X | X | X | X | X | X |

default value 01h

| Field | Bit   | Type | Description |
|-------|-------|------|-------------|
| NA    | 7 : 0 | R    | Reserved    |

## OALS\_DATA ( 4Ch, 4Dh )

|          |   |   |   |   |   |   |   |
|----------|---|---|---|---|---|---|---|
| 7        | 6 | 5 | 4 | 3 | 2 | 1 | 0 |
| ALS data |   |   |   |   |   |   |   |

default value 00h

| Register      | Address | Bit   | Type | Description        |
|---------------|---------|-------|------|--------------------|
| ALS data LSBs | 4Ch     | 7 : 0 | R    | ALS data Low byte  |
| ALS data MSBs | 4Dh     | 7 : 0 | R    | ALS data High byte |

## OALS\_PS\_STATUS ( 4Eh )

|                |                 |          |   |   |   |               |                |
|----------------|-----------------|----------|---|---|---|---------------|----------------|
| 7              | 6               | 5        | 4 | 3 | 2 | 1             | 0              |
| ALS INT status | ALS data status | Reserved |   |   |   | PS INT status | PS data status |

default value 00h

| Field           | Bit   | Type | Description  |
|-----------------|-------|------|--|
| ALS INT status  | 7     | R    | 0 : ALS interrupt signal inactive<br>1 : ALS interrupt signal active                                 |
| ALS data status | 6     | R    | 0 : ALS old data (data is already read)<br>1 : ALS new data (data is renewed after previous reading) |
| Reserved        | 5 : 2 | R    | -  |
| PS INT status   | 1     | R    | 0 : PS interrupt signal inactive<br>1 : PS interrupt signal active                                   |
| PS data status  | 0     | R    | 0 : PS old data (data is already read)<br>1 : PS new data (data is renewed after previous reading)   |

ALS interrupt signal inactive means that ALS measurement result is within threshold level set by ALS\_TH register(56h, 57h, 58h, 59h). ALS interrupt signal active means measurement result is out of threshold level set by ALS\_TH register. PS interrupt signal active means PS measurement result exceeds threshold level defined by PS\_TH\_H register(53h). PS interrupt signal inactive means PS measurement result does not exceed threshold level set by PS\_TH\_H register. When PS interrupt hysteresis( INTERRUPT register 52h<4>) is 'H', if once interrupt signal becomes active, it is kept until measurement result becomes less than PS\_TH\_L(5Ch) register value.

## OPS\_DATA ( 4Fh )

|         |   |   |   |   |   |   |   |
|---------|---|---|---|---|---|---|---|
| 7       | 6 | 5 | 4 | 3 | 2 | 1 | 0 |
| PS data |   |   |   |   |   |   |   |

default value 00h

| Register | Bit   | Type | Description         |
|----------|-------|------|---------------------|
| PS data  | 7 : 0 | R    | PS measurement data |

## OReserved register 4 ( 50h )

|   |   |   |   |   |   |   |   |
|---|---|---|---|---|---|---|---|
| 7 | 6 | 5 | 4 | 3 | 2 | 1 | 0 |
| X | X | X | X | X | X | X | X |

default value 00h

| Field    | Bit   | Type | Description |
|----------|-------|------|-------------|
| Reserved | 7 : 0 | R    | Reserved    |

## OReserved register 5 ( 51h )

|   |   |   |   |   |   |   |   |
|---|---|---|---|---|---|---|---|
| 7 | 6 | 5 | 4 | 3 | 2 | 1 | 0 |
| X | X | X | X | X | X | X | X |

default value 00h

| Field    | Bit   | Type | Description |
|----------|-------|------|-------------|
| Reserved | 7 : 0 | R    | Reserved    |

## OINTERRUPT ( 52h )

|   |   |                         |                               |                |                       |                |   |
|---|---|-------------------------|-------------------------------|----------------|-----------------------|----------------|---|
| 7 | 6 | 5                       | 4                             | 3              | 2                     | 1              | 0 |
| X | X | Interru<br>pt<br>source | PS<br>Interrupt<br>hysteresis | Output<br>mode | Interrupt<br>polarity | Interrupt mode |   |

default value 08h

| Field                   | Bit   | Type | Description  |
|-------------------------|-------|------|--|
| NA                      | 7 : 6 | -    | Ignored  |
| Interrupt source        | 5     | R    | 0 : First interrupt triggered by ALS<br>1 : First interrupt triggered by PS  |
| PS Interrupt hysteresis | 4     | RW   | 0 : Use PS_TH_H only.<br>1 : Use PS_TH_H and PS_TH_L for hysteresis  |
| Output mode             | 3     | RW   | 0 : INT pin is latched until INTERRUPT register is read.<br>1 : INT pin is updated after each measurement.   |
| Interrupt polarity      | 2     | RW   | 0 : INT pin is logic 'L' when interrupt signal is active<br>1 : INT pin is logic 'L' when interrupt signal is inactive                                   |
| Interrupt mode          | 1 : 0 | RW   | 00 : INT pin is inactive.<br>01 : Triggered by only PS measurement<br>10 : Triggered by only ALS measurement<br>11 : Triggered by PS and ALS measurement |

## OPS\_TH\_H ( 53h )

|                |   |   |   |   |   |   |   |
|----------------|---|---|---|---|---|---|---|
| 7              | 6 | 5 | 4 | 3 | 2 | 1 | 0 |
| PS H threshold |   |   |   |   |   |   |   |

default value FFh

| Register | Bit   | Type | Description                    |
|----------|-------|------|--------------------------------|
| PS_TH_H  | 7 : 0 | RW   | PS Interrupt H threshold level |

## OReserved register 6 ( 54h )

|          |   |   |   |   |   |   |   |
|----------|---|---|---|---|---|---|---|
| 7        | 6 | 5 | 4 | 3 | 2 | 1 | 0 |
| Reserved |   |   |   |   |   |   |   |

default value FFh

| Field    | Bit   | Type | Description      |
|----------|-------|------|------------------|
| Reserved | 7 : 0 | RW   | write "11111111" |

## OReserved register 7 ( 55h )

|          |   |   |   |   |   |   |   |
|----------|---|---|---|---|---|---|---|
| 7        | 6 | 5 | 4 | 3 | 2 | 1 | 0 |
| Reserved |   |   |   |   |   |   |   |

default value FFh

| Field    | Bit   | Type | Description      |
|----------|-------|------|------------------|
| Reserved | 7 : 0 | RW   | write "11111111" |

## OALS\_TH\_UP ( 56h, 57h )

|                          |   |   |   |   |   |   |   |
|--------------------------|---|---|---|---|---|---|---|
| 7                        | 6 | 5 | 4 | 3 | 2 | 1 | 0 |
| ALS upper threshold data |   |   |   |   |   |   |   |

default value FFh

| Register          | Address | Bit   | Type | Description                               |
|-------------------|---------|-------|------|---|
| ALS TH upper LSBs | 56h     | 7 : 0 | RW   | ALS interrupt upper threshold (Low byte)  |
| ALS TH upper MSBs | 57h     | 7 : 0 | RW   | ALS interrupt upper threshold (High byte) |

## OALS\_TH\_LOW ( 58h, 59h )

|                          |   |   |   |   |   |   |   |
|--------------------------|---|---|---|---|---|---|---|
| 7                        | 6 | 5 | 4 | 3 | 2 | 1 | 0 |
| ALS lower threshold data |   |   |   |   |   |   |   |

default value 00h

| Register          | Address | Bit   | Type | Description                               |
|-------------------|---------|-------|------|---|
| ALS TH lower LSBs | 58h     | 7 : 0 | RW   | ALS interrupt lower threshold (Low byte)  |
| ALS TH lower MSBs | 59h     | 7 : 0 | RW   | ALS interrupt lower threshold (High byte) |

## OALS\_SENSITIVITY ( 5Ah )

|                      |   |   |   |   |   |   |   |
|----------------------|---|---|---|---|---|---|---|
| 7                    | 6 | 5 | 4 | 3 | 2 | 1 | 0 |
| ALS sensitivity data |   |   |   |   |   |   |   |

default value 35h

| Register             | Bit   | Type | Description  |
|----------------------|-------|------|--|
| ALS sensitivity data | 7 : 0 | RW   | ALS sensitivity adjustment register (refer to P24) |

## OPERSISTENCE ( 5Bh )

|                 |   |   |   |                |   |   |   |
|-----------------|---|---|---|----------------|---|---|---|
| 7               | 6 | 5 | 4 | 3              | 2 | 1 | 0 |
| ALS persistence |   |   |   | PS persistence |   |   |   |

default value 11h

| Field           | Bit   | Type | Description                    |
|-----------------|-------|------|--------------------------------|
| ALS persistence | 7 : 4 | RW   | Persistence for ALS interrupt. |
| PS persistence  | 3 : 0 | RW   | Persistence for PS interrupt.  |

## OPS\_TH\_L ( 5Ch )

|                |   |   |   |   |   |   |   |
|----------------|---|---|---|---|---|---|---|
| 7              | 6 | 5 | 4 | 3 | 2 | 1 | 0 |
| PS L threshold |   |   |   |   |   |   |   |

default value 00h

| Register | Bit   | Type | Description                    |
|----------|-------|------|--------------------------------|
| PS_TH_L  | 7 : 0 | RW   | PS Interrupt L threshold level |

## OReserved register 8 ( 5Dh )

|          |   |   |   |   |   |   |   |
|----------|---|---|---|---|---|---|---|
| 7        | 6 | 5 | 4 | 3 | 2 | 1 | 0 |
| Reserved |   |   |   |   |   |   |   |

default value 00h

| Field    | Bit   | Type | Description      |
|----------|-------|------|------------------|
| Reserved | 7 : 0 | RW   | write "00000000" |

## OReserved register 9 ( 5Eh )

|          |   |   |   |   |   |   |   |
|----------|---|---|---|---|---|---|---|
| 7        | 6 | 5 | 4 | 3 | 2 | 1 | 0 |
| Reserved |   |   |   |   |   |   |   |

default value 00h

| Field    | Bit   | Type | Description      |
|----------|-------|------|------------------|
| Reserved | 7 : 0 | RW   | write "00000000" |

## ●Current consumption

BH1772GLC can operate ALS and PS individually. Average current consumption is depend on each statuses and measurement duration (set by 45h, 46h register). Major elements which decide VCC current consumption are like following table.

| Parameter                     | Symbol | Typ. | Units | Comment   |
|-------------------------------|--------|------|-------|---|
| ALS part's current            | IccALS | 140  | μA    | Except for ALS/PS common circuit current.                           |
| PS part's current             | IccPS  | 250  | μA    | Except for ALS/PS common circuit current.<br>Current flow for 1.4ms |
| PS current during driving LED | Icc3   | 6.5  | mA    |   |
| ALS/PS common circuit current | Icccmn | 60   | μA    |   |

- 1) Current consumption in case of operating only ALS  
VCC current consumption can calculate according to following formula.

$$ICC(\text{only ALS}) = IccALS * ( 100ms / ALS \text{ meas rate } ) + Icccmn$$

For example in case measurement rate is 500ms, the value is as following.

$$\text{e. g. ) } ICC(\text{onlyALS}) = 140\mu A (100ms / 500ms) + 60\mu A = 88\mu A$$

- 2) Current consumption in case of operating only PS  
VCC current consumption can calculate according to following formula.

$$ICC(\text{only PS}) = IccPS * ( 1.4ms / PS \text{ meas rate } ) + Icccmn + Icc3 * ( 200\mu s / PS \text{ meas rate } )$$

VDD\_LED current consumption can calculate according to following formula.

$$IVDD\_LED = 200\mu s / PS \text{ meas rate}$$

For example in case it drives 50mA and measurement rate is 100ms, the value is as following.

$$\text{e. g. ) } ICC(\text{onlyPS}) = 250\mu A * ( 1.4ms / 100ms ) + 60\mu A + 6.5mA * ( 200\mu s / 100ms ) = 76.5\mu A$$

$$IVDD\_LED = 50mA * (200\mu s / 100ms) = 100\mu A$$

- 3) Current consumption in case of operating ALS and PS at the same time.  
VCC current consumption can calculate according to following formula.

$$ICC(\text{ALS+PS}) = ICC(\text{onlyALS}) + ICC(\text{onlyPS}) - Icccmn$$

For example in case ALS measurement rate is 500ms and PS measurement rate is 100ms and it drives 50mA, the value is as following.

$$\text{e.g. ) } ICC(\text{ALS+PS}) = 88\mu A + 76.5\mu A - 60\mu A = 104.5\mu A$$

VDD\_LED current consumption can calculate same as the case of operating only PS.

- 4) In case of waiting trigger at forced mode  
ALS/PScommon cucuit current (Icccmn) is flow.

●ALS Measurement mode explanation

| Measurement Mode  | Measurement Time | Resolution |
|-------------------|------------------|------------|
| H-Resolution mode | typ. 100ms.      | 1 Lx       |
| M-Resolution mode | typ.16ms.        | 4 Lx       |

We recommend to use H-Resolution Mode.

Measurement time ( integration time ) of H-Resolution mode is so long that some kind of noise( including in 50Hz / 60Hz noise ) is rejected. And H-Resolution mode is 1 lx resolution so that it is suitable for darkness.

●Regarding ALS measurement result

ALS measurement result is registered as following format

ALS DATA LSB ( 4Ch )

|       |       |       |       |       |       |       |       |
|-------|-------|-------|-------|-------|-------|-------|-------|
| 7     | 6     | 5     | 4     | 3     | 2     | 1     | 0     |
| $2^7$ | $2^6$ | $2^5$ | $2^4$ | $2^3$ | $2^2$ | $2^1$ | $2^0$ |

ALS DATA MSB ( 4Dh )

|          |          |          |          |          |          |       |       |
|----------|----------|----------|----------|----------|----------|-------|-------|
| 7        | 6        | 5        | 4        | 3        | 2        | 1     | 0     |
| $2^{15}$ | $2^{14}$ | $2^{13}$ | $2^{12}$ | $2^{11}$ | $2^{10}$ | $2^9$ | $2^8$ |

ALS Lux calculation example

ALS DATA LSB = " 1001\_0000 "

ALS DATA MSB = " 1000\_0011 "

$$( 2^{15} + 2^9 + 2^8 + 2^7 + 2^4 ) \doteq 33680 [ lx ]$$

●Regarding PS measurement result

PS measurement result is converted to logarithm 8bit data and is registered as following format

PS\_DATA ( 4Fh )

|       |       |       |       |       |       |       |       |
|-------|-------|-------|-------|-------|-------|-------|-------|
| 7     | 6     | 5     | 4     | 3     | 2     | 1     | 0     |
| $2^7$ | $2^6$ | $2^5$ | $2^4$ | $2^3$ | $2^2$ | $2^1$ | $2^0$ |

The data seeing above register is possible to change the irradiance.

Approximation formula is seeing in below.

$$\text{Irradiance} : 10 ^ { ( \text{PS\_DATA} * 0.0197 ) } [ \mu \text{W} / \text{cm}^2 ]$$

PS irradiance calculation example

PS\_DATA = " 1000\_0101 "

$$10 ^ { ( ( 2^7 + 2^2 + 2^0 ) * 0.0197 ) } = 10 ^ { ( 133 * 0.0197 ) } \doteq 417 [ \mu \text{W} / \text{cm}^2 ]$$

### ●ALS sensitivity adjustment function

BH1772GLC is possible to change ALS sensitivity. And it is possible to cancel the optical window influence ( difference with / without optical window ) by using this function. Adjustment is done by changing measurement time. For example, when transmission rate of optical window is 50% (measurement result becomes 0.5 times if optical window is set), influence of optical window is ignored by changing sensor sensitivity from default to 2 times.

Sensitivity can be adjusted by ALS\_SENSITIVITY(5Ah). For example, sensitivity 2 times when the value of the register is 2 times, and the measurement time 2 times, too.

The range of adjusting ALS\_SENSITIVITY is below.

|                                     |         | Min.  | Typ.                 | Max.  |
|-------------------------------------|---------|---|----------------------|---|
| Adjustable range of ALS_SENSITIVITY | binary  | 0001_1000<br>(sensitivity: default * 0.45 ) | 0011_0101<br>default | 1111_1110<br>(sensitivity: default * 4.79 ) |
|                                     | decimal | 24<br>(sensitivity: default * 0.45 )        | 53<br>default        | 254<br>(sensitivity: default * 4.79 )       |

It is possible to detect 0.21lx by using this function at H-resolution mode.

The below formula is to calculate illuminant per 1 count.

$$\text{Illuminant per 1 count ( lx / count )} = 1 * 53 / X$$

53 : Default value of ALS\_SENSITIVITY register (decimal)

X : ALS\_SENSITIVITY register value (decimal)

Illuminant per 1 count is as following within adjustable range of ALS\_SENSITIVITY.

| ALS_SENSITIVITY register value | Illuminant per 1count(lx / count) |
|--------------------------------|-----------------------------------|
| 0001_1000                      | 2.21                              |
| 0011_0101                      | 1.00                              |
| 1111_1110                      | 0.21                              |

Please input the opcode at Power Down state to change ALS\_SENSITIVITY register. There is a possibility of malfunction when the opcode to change ALS\_SENSITIVITY register is input while the illuminant measurement is on-going

In stand alone mode, if ALS measurement time exceeds the value defined ALS\_MEAS\_RATE register, ALS\_MEAS\_RATE register value is ignored. Next measurement is started immediately after one measurement completion.



●Recommended land pattern

Bottom View

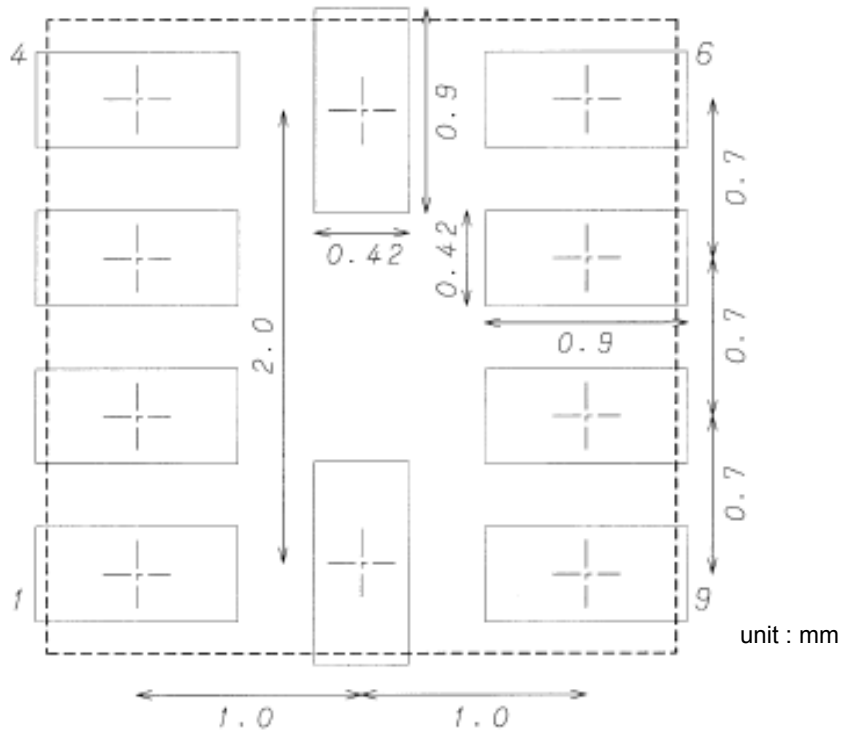

●Optical window design above the device

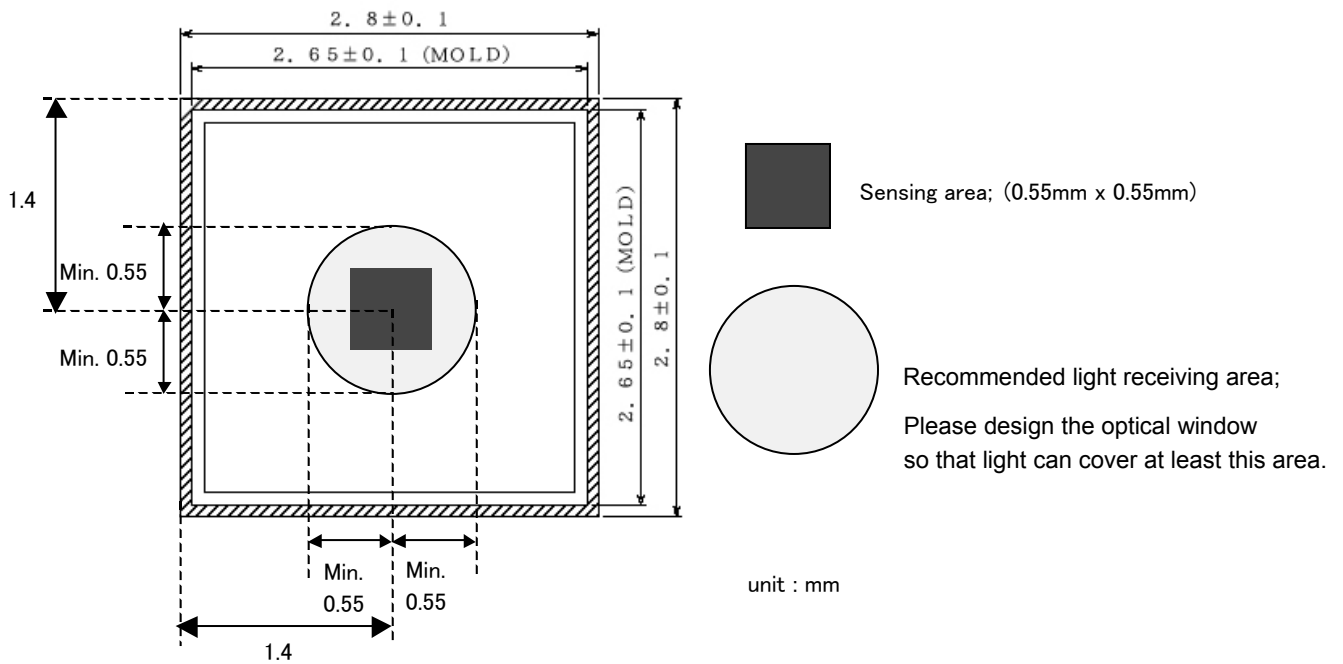

●The method of distinguishing 1pin

There is the following methods of distinguishing 1pin.

- ① Distinguishing by Pad design of top side.  
There are 5 pads in the one side of a top side. There is a space between 2 pads and 3 pads.
- ② Distinguishing by Die pattern.

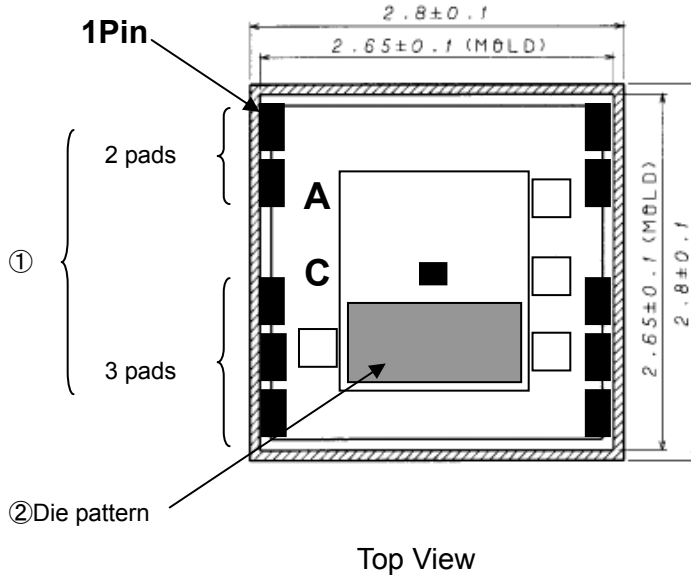

- ③ Distinguishing by Pad design of bottom side.

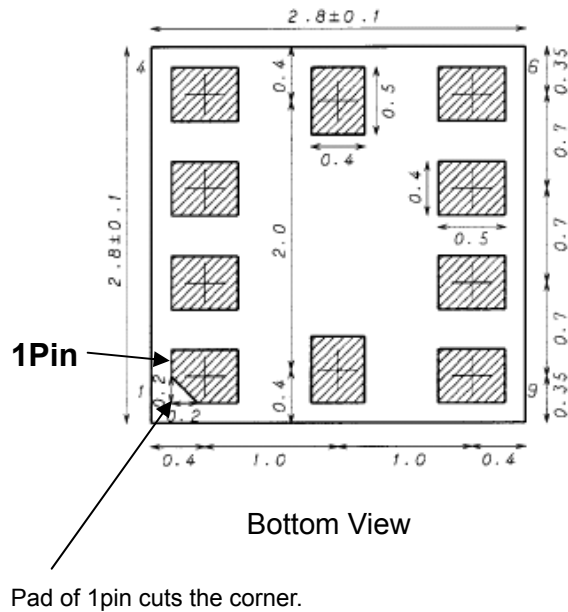

●Power on reset function

BH1772GLC has power on reset function. By operating this function, all of registers are reset when the power is supplied. Please note followings and design the application.

- ① Power on time :  $t_1$   
BH1772GLC becomes operational after 2ms since VCC voltage crosses 1.9V from being less than 0.4V.
- ② Power off time :  $t_2$   
Before the power is supplied, VCC voltage should be less than 0.4V at least for 1ms.

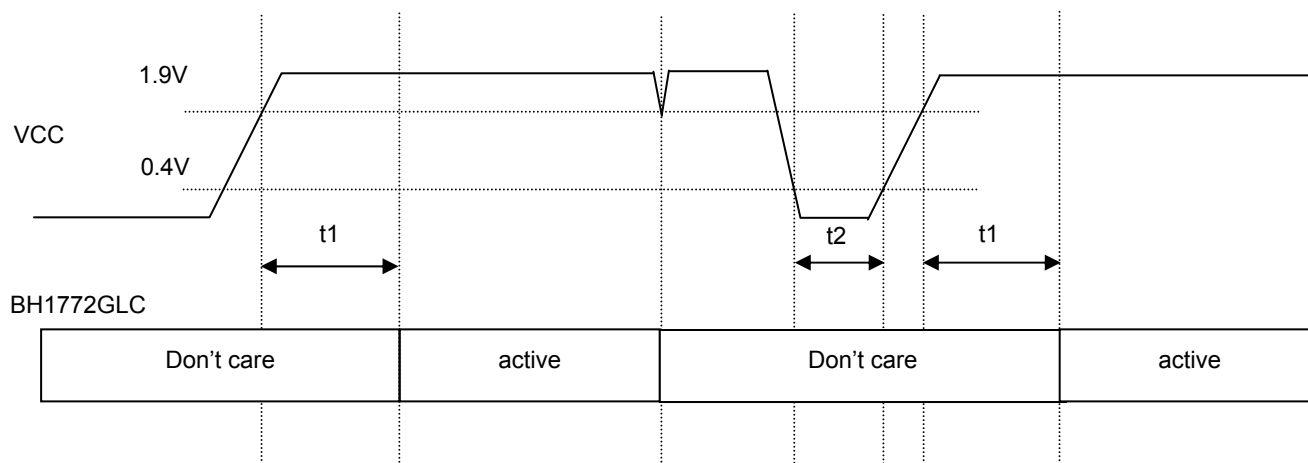

\*"active state" means that BH1772GLC is correctly operational.

INT terminal is high impedance when VCC is supplied.

**●Cautions on use**

- 1) Absolute Maximum Ratings  
An excess in the absolute maximum ratings, such as supply voltage (  $V_{ccmax}$ ,  $V_{SDAmax}$ ,  $V_{SCLmax}$ ,  $V_{INTmax}$ ,  $V_{GNDNCmax}$ ,  $V_{LEDCmax}$  ), temperature range of operating conditions (  $T_{opr}$  ), etc., can break down devices, thus making impossible to identify breaking mode such as a short circuit or an open circuit. If any special mode exceeding the absolute maximum ratings is assumed, consideration should be given to take physical safety measures including the use of fuses, etc.
- 2) GND voltage  
Make setting of the potential of the GND terminal and GND\_LED terminal so that they will be maintained at the minimum in any operating state. Furthermore, check to be sure no terminals are at a potential lower than the GND voltage including an actual electric transient.
- 3) Short circuit between terminals and erroneous mounting  
In order to mount ICs on a set PCB, pay thorough attention to the direction and offset of the ICs. Erroneous mounting can break down the ICs. Furthermore, if a short circuit occurs due to foreign matters entering between terminals or between the terminal and the power supply or the GND terminal, the ICs can break down.
- 4) Operation in strong electromagnetic field  
Be noted that using ICs in the strong electromagnetic field can malfunction them.
- 5) Inspection with set PCB  
On the inspection with the set PCB, if a capacitor is connected to a low-impedance IC terminal, the IC can suffer stress. Therefore, be sure to discharge from the set PCB by each process. Furthermore, in order to mount or dismount the set PCB to/from the jig for the inspection process, be sure to turn OFF the power supply and then mount the set PCB to the jig. After the completion of the inspection, be sure to turn OFF the power supply and then dismount it from the jig. In addition, for protection against static electricity, establish a ground for the assembly process and pay thorough attention to the transportation and the storage of the set PCB.
- 6) Input terminals  
In terms of the construction of IC, parasitic elements are inevitably formed in relation to potential. The operation of the parasitic element can cause interference with circuit operation, thus resulting in a malfunction and then breakdown of the input terminal. Therefore, pay thorough attention not to handle the input terminals; such as to apply to the input terminals a voltage lower than the GND respectively, so that any parasitic element will operate. In addition, apply to the input terminals a voltage within the guaranteed value of electrical characteristics.
- 7) Thermal design  
Perform thermal design in which there are adequate margins by taking into account the power dissipation (  $P_d$  ) in actual states of use.
- 8) Treatment of package  
Dusts or scratch on the photo detector may affect the optical characteristics. Please handle it with care.
- 9) RUSH current  
When power is first supplied to the CMOS IC, it is possible that the internal logic may be unstable and rush current may flow instantaneously. Therefore, give special consideration to power coupling capacitance, power wiring, width of GND wiring, and routing of connections.

●Ordering part number

|   |   |
|---|---|
| B | H |
|---|---|

Part No.

|   |   |   |   |
|---|---|---|---|
| 1 | 7 | 7 | 2 |
|---|---|---|---|

Part No.

|   |   |   |
|---|---|---|
| G | L | C |
|---|---|---|

Package  
GLC: WLGA010V28

|   |   |
|---|---|
| E | 2 |
|---|---|

Packaging and forming specification  
E2: Embossed tape and reel

WLGA010V28

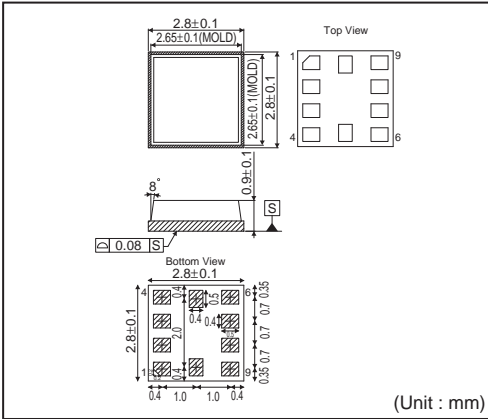

<Tape and Reel information>

|                   |   |
|-------------------|---|
| Tape              | Embossed carrier tape (with dry pack)   |
| Quantity          | 3000pcs   |
| Direction of feed | E2<br>( The direction is the 1pin of product is at the upper left when you hold reel on the left hand and you pull out the tape on the right hand ) |

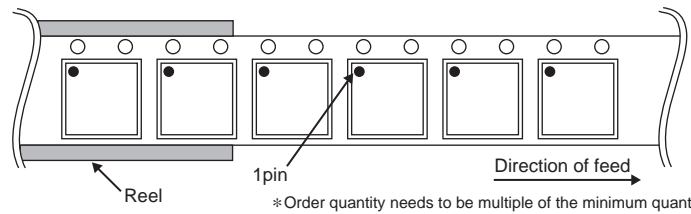

## Notes

No copying or reproduction of this document, in part or in whole, is permitted without the consent of ROHM Co.,Ltd.

The content specified herein is subject to change for improvement without notice.

The content specified herein is for the purpose of introducing ROHM's products (hereinafter "Products"). If you wish to use any such Product, please be sure to refer to the specifications, which can be obtained from ROHM upon request.

Examples of application circuits, circuit constants and any other information contained herein illustrate the standard usage and operations of the Products. The peripheral conditions must be taken into account when designing circuits for mass production.

Great care was taken in ensuring the accuracy of the information specified in this document. However, should you incur any damage arising from any inaccuracy or misprint of such information, ROHM shall bear no responsibility for such damage.

The technical information specified herein is intended only to show the typical functions of and examples of application circuits for the Products. ROHM does not grant you, explicitly or implicitly, any license to use or exercise intellectual property or other rights held by ROHM and other parties. ROHM shall bear no responsibility whatsoever for any dispute arising from the use of such technical information.

The Products specified in this document are intended to be used with general-use electronic equipment or devices (such as audio visual equipment, office-automation equipment, communication devices, electronic appliances and amusement devices).

The Products specified in this document are not designed to be radiation tolerant.

While ROHM always makes efforts to enhance the quality and reliability of its Products, a Product may fail or malfunction for a variety of reasons.

Please be sure to implement in your equipment using the Products safety measures to guard against the possibility of physical injury, fire or any other damage caused in the event of the failure of any Product, such as derating, redundancy, fire control and fail-safe designs. ROHM shall bear no responsibility whatsoever for your use of any Product outside of the prescribed scope or not in accordance with the instruction manual.

The Products are not designed or manufactured to be used with any equipment, device or system which requires an extremely high level of reliability the failure or malfunction of which may result in a direct threat to human life or create a risk of human injury (such as a medical instrument, transportation equipment, aerospace machinery, nuclear-reactor controller, fuel-controller or other safety device). ROHM shall bear no responsibility in any way for use of any of the Products for the above special purposes. If a Product is intended to be used for any such special purpose, please contact a ROHM sales representative before purchasing.

If you intend to export or ship overseas any Product or technology specified herein that may be controlled under the Foreign Exchange and the Foreign Trade Law, you will be required to obtain a license or permit under the Law.



Thank you for your accessing to ROHM product informations.  
More detail product informations and catalogs are available, please contact us.

### ROHM Customer Support System

<http://www.rohm.com/contact/>

Компания «Океан Электроники» предлагает заключение долгосрочных отношений при поставках импортных электронных компонентов на взаимовыгодных условиях!

Наши преимущества:

- Поставка оригинальных импортных электронных компонентов напрямую с производств Америки, Европы и Азии, а так же с крупнейших складов мира;
- Широкая линейка поставок активных и пассивных импортных электронных компонентов (более 30 млн. наименований);
- Поставка сложных, дефицитных, либо снятых с производства позиций;
- Оперативные сроки поставки под заказ (от 5 рабочих дней);
- Экспресс доставка в любую точку России;
- Помощь Конструкторского Отдела и консультации квалифицированных инженеров;
- Техническая поддержка проекта, помощь в подборе аналогов, поставка прототипов;
- Поставка электронных компонентов под контролем ВП;
- Система менеджмента качества сертифицирована по Международному стандарту ISO 9001;
- При необходимости вся продукция военного и аэрокосмического назначения проходит испытания и сертификацию в лаборатории (по согласованию с заказчиком);
- Поставка специализированных компонентов военного и аэрокосмического уровня качества (Xilinx, Altera, Analog Devices, Intersil, Interpoint, Microsemi, Actel, Aeroflex, Peregrine, VPT, Syfer, Eurofarad, Texas Instruments, MS Kennedy, Miteq, Cobham, E2V, MA-COM, Hittite, Mini-Circuits, General Dynamics и др.);

Компания «Океан Электроники» является официальным дистрибьютором и эксклюзивным представителем в России одного из крупнейших производителей разъемов военного и аэрокосмического назначения «JONHON», а так же официальным дистрибьютором и эксклюзивным представителем в России производителя высокотехнологичных и надежных решений для передачи СВЧ сигналов «FORSTAR».



## JONHON

«JONHON» (основан в 1970 г.)

Разъемы специального, военного и аэрокосмического назначения:

(Применяются в военной, авиационной, аэрокосмической, морской, железнодорожной, горно- и нефтедобывающей отраслях промышленности)

«FORSTAR» (основан в 1998 г.)

ВЧ соединители, коаксиальные кабели,  
кабельные сборки и микроволновые компоненты:

(Применяются в телекоммуникациях гражданского и специального назначения, в средствах связи, РЛС, а так же военной, авиационной и аэрокосмической отраслях промышленности).



Телефон: 8 (812) 309-75-97 (многоканальный)

Факс: 8 (812) 320-03-32

Электронная почта: [ocean@oceanchips.ru](mailto:ocean@oceanchips.ru)

Web: <http://oceanchips.ru/>

Адрес: 198099, г. Санкт-Петербург, ул. Калинина, д. 2, корп. 4, лит. А