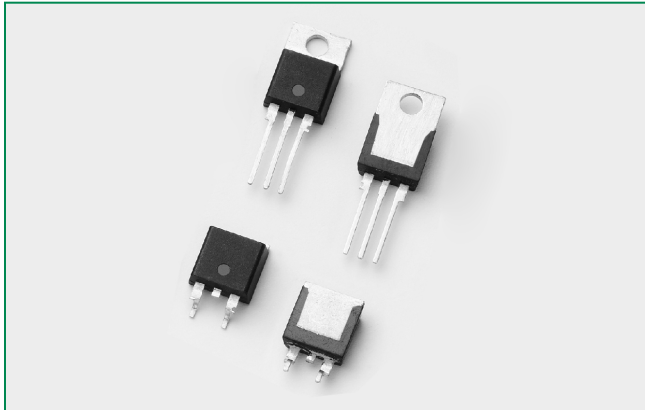


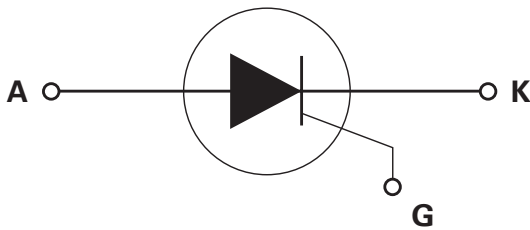
## S8016xA Series



### Main Features

Symbol	Value	Unit
$I_{T(RMS)}$	16	A
$V_{DRM}/V_{RRM}$	800	V
$I_{GT}$	50	mA

### Schematic Symbol



### Description

The Littelfuse SCR S8016xA series are specifically designed for Electric Vehicle On-Board Charger (EVOBC) applications. This SCR AC line input rectifier can handle Level 1 charging up to 16Arms at 120V, and Level 2 charging up to 16A rms at 240V at 100°C and up to 25A rms for 80°C. Its excellent AC handling capability and surge robustness makes this series an ideal switch for these input rectifiers.

### Features & Benefits

- $V_{DRM}$  800V,  $I_T$  25rms to handle input from 100-250V line AC
- High di/dt of 375/μsec enables handling of 3kA 8/20 surge current operationally
- High  $V_{DSM}/V_{RSM}$  of 1300V, high dv/dt of 2000V/μsec prevents SCR mis-triggering during 6kV 1.2/50-8/20 surge event with minimal over voltage protection or snubber circuit
- Available in the compact TO-263 SMT package
- AEC-Q101 Fully Compliant
- Halogen free and RoHS compliant

### Applications

Input rectification of AC line input for EVOBC applications.

### Absolute Maximum Ratings

Symbol	Parameter	Test Conditions	Value	Unit
$V_{DSM}/V_{RSM}$	Peak non-repetitive blocking voltage	$P_w=100\mu s$	1300	V
$I_{T(RMS)}$	RMS on-state current	$T_c=100^\circ C$	16	A
		$T_c=80^\circ C$	25	
$I_{T(AV)}$	Average on-state current	$T_c=100^\circ C$	10	A
		$T_c=80^\circ C$	16	
$I_{TSM}$	Peak non-repetitive surge current	single half cycle; $f=50Hz$ ; $T_J$ (initial)=25°C	188	A
		single half cycle; $f=60Hz$ ; $T_J$ (initial)=25°C	225	
$I^2t$	$I^2t$ Value for fusing	$t_p=8.3 ms$	210	A <sup>2</sup> s
$I_{PP}$	Non-repetitive peak surge current	with Littelfuse MOV V20E420AUTO across line; $T_J=125^\circ C$ , 11.2/50-8/20 combination wave, $I_T=1A$	2400	A
di/dt	Critical rate of rise of on-state current	$T_J=125^\circ C$	375	A/μs
$I_{GM}$	Peak gate current	$T_J=125^\circ C$	3.0	A
$P_{G(AV)}$	Average gate power dissipation	$T_J=125^\circ C$	0.6	W
$T_{stg}$	Storage temperature range		-40 to 150	°C
$T_J$	Operating junction temperature range		-40 to 125	°C

**Electrical Characteristics (T<sub>J</sub> = 25°C, unless otherwise specified)**

Symbol	Test Conditions		Value	Unit
I <sub>GT</sub>	V <sub>D</sub> =12V; R <sub>L</sub> =30Ω	MIN.	15	mA
		MAX.	50	
V <sub>GT</sub>		MAX.	1.5	V
dv/dt	V <sub>D</sub> =V <sub>DRM</sub> ; gate open; T <sub>J</sub> =125°C	MIN.	2000	V/μs
	1.2/50 pulse wave, with 250V AC with Littelfuse MOV V20E420AUTO across	MIN.	5	KV/μs
V <sub>GD</sub>	V <sub>D</sub> =V <sub>DRM</sub> ; R <sub>L</sub> =3.3 kΩ; T <sub>J</sub> =125°C	MIN.	0.2	V
I <sub>H</sub>	I <sub>T</sub> =400mA (initial)	MAX.	150	mA
t <sub>q</sub>	I <sub>T</sub> =0.5A; t <sub>p</sub> =50μs; dv/dt=5V/μs; di/dt=-30A/μs	MAX.	35	μs
t <sub>gt</sub>	I <sub>G</sub> =2 × I <sub>GT</sub> ; PW=15μs; I <sub>T</sub> =40A	TYP.	2	μs

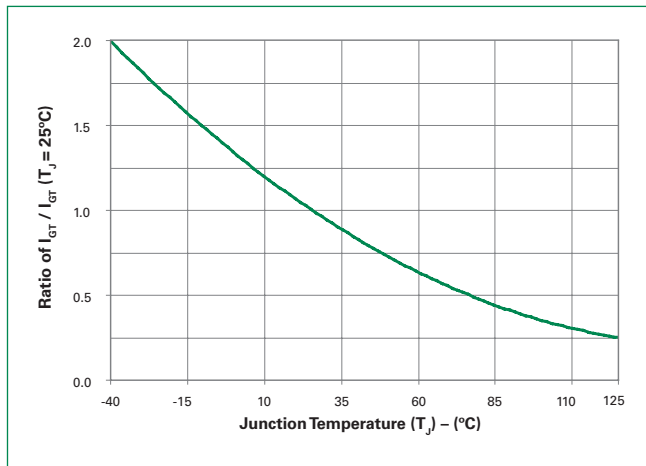
**Static Characteristics**

Symbol	Test Conditions		Value	Unit
V <sub>TM</sub>	I <sub>T</sub> =32A; t <sub>p</sub> =380μs	MAX.	1.4	V
I <sub>DRM</sub> / I <sub>RRM</sub>	@ V <sub>DRM</sub> / V <sub>RRM</sub>	T <sub>J</sub> =25°C	20	μA
		T <sub>J</sub> =100°C	1000	
		T <sub>J</sub> =125°C	2000	

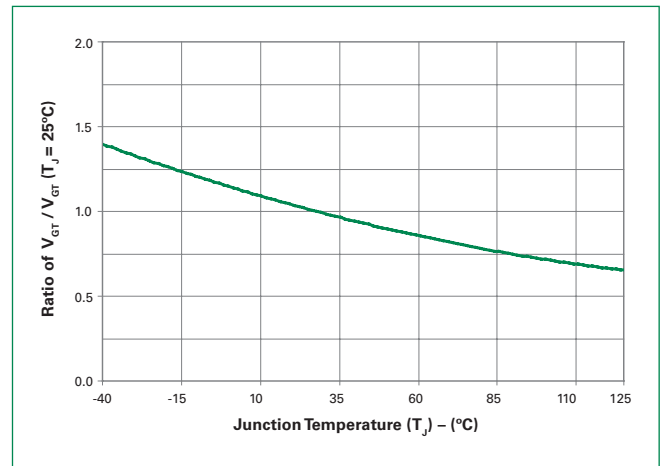
**Thermal Resistances**

Symbol	Parameter	Value	Unit
R <sub>θ(J-C)</sub>	Junction to case (AC)	1.0	°C/W

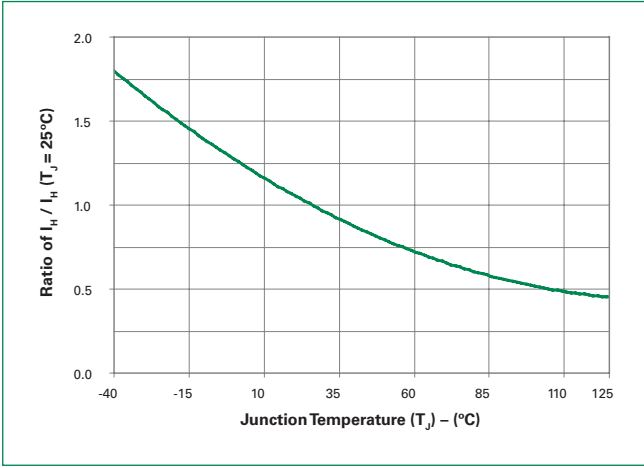
**Figure 1: Normalized DC Gate Trigger Current vs. Junction Temperature**



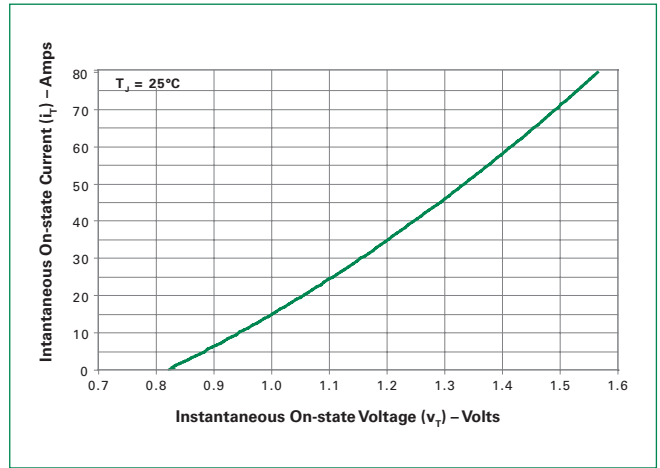
**Figure 2: Normalized DC Gate Trigger Voltage vs. Junction Temperature**



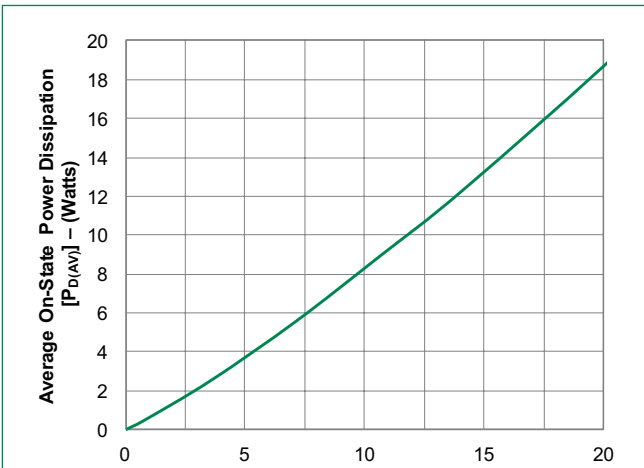
**Figure 3: Normalized DC Holding Current vs. Junction Temperature**



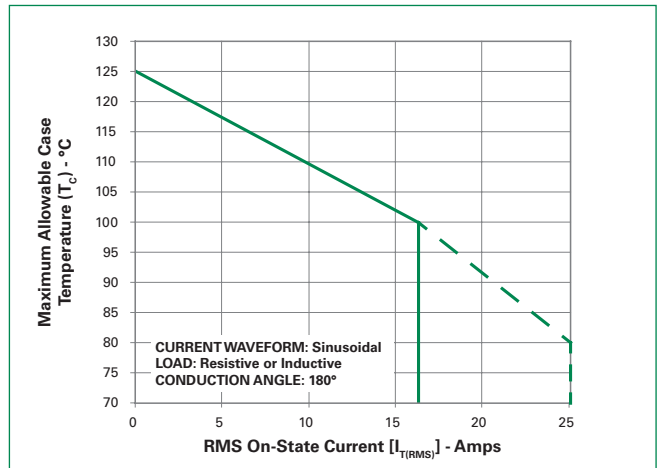
**Figure 4: On-State Current vs. On-State Voltage (Typical)**



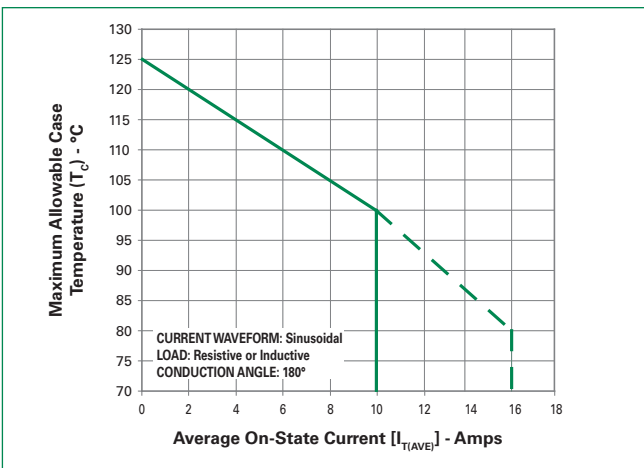
**Figure 5: Power Dissipation (Typical) vs. RMS On-State Current**



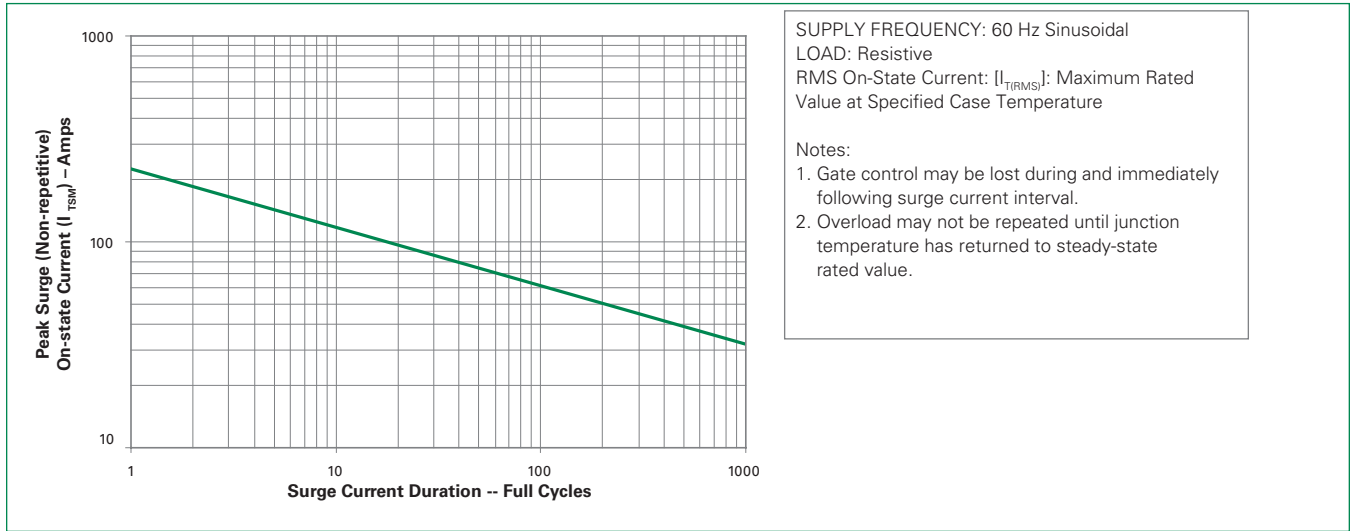
**Figure 6: Maximum Allowable Case Temperature vs. RMS On-State Current**



**Figure 7: Maximum Allowable Case Temperature vs. Average On-State Current**

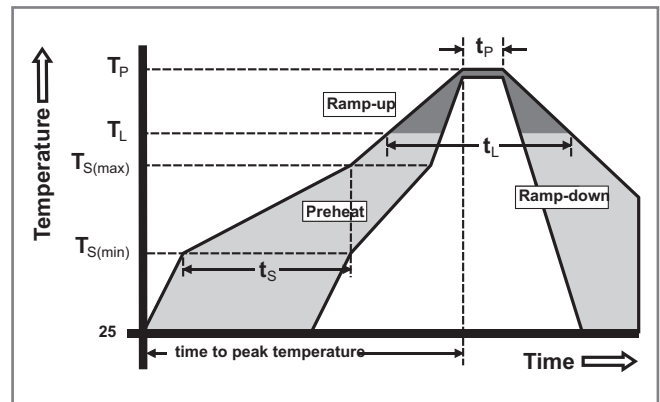


**Figure 8: Surge Peak On-State Current vs. Number of Cycles**



**Soldering Parameters**

Reflow Condition		Pb – Free assembly
Pre Heat	- Temperature Min ( $T_{s(min)}$ )	150°C
	- Temperature Max ( $T_{s(max)}$ )	200°C
	- Time (min to max) ( $t_s$ )	60 – 180 secs
Average ramp up rate (Liquidus Temp) ( $T_L$ ) to peak		5°C/second max
$T_{s(max)}$ to $T_L$ - Ramp-up Rate		5°C/second max
Reflow	- Temperature ( $T_L$ ) (Liquidus)	217°C
	- Time ( $t_L$ )	60 – 150 seconds
Peak Temperature ( $T_p$ )		260 <sup>+0/-5</sup> °C
Time within 5°C of actual peak Temperature ( $t_p$ )		20 – 40 seconds
Ramp-down Rate		5°C/second max
Time 25°C to peak Temperature ( $T_p$ )		8 minutes Max.
Do not exceed		280°C



**Physical Specifications**

<b>Terminal Finish</b>	100% Matte Tin-plated
<b>Body Material</b>	UL Recognized epoxy meeting flammability rating V-0
<b>Lead Material</b>	Copper Alloy

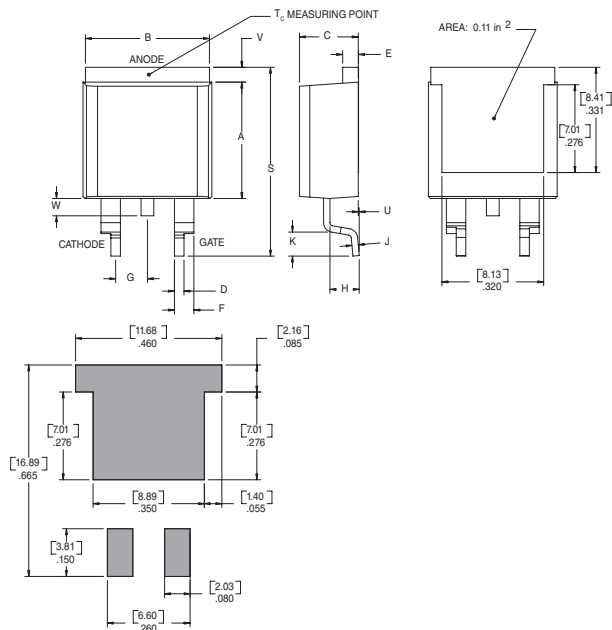
**Design Considerations**

Careful selection of the correct component for the application's operating parameters and environment will go a long way toward extending the operating life of the Thyristor. Good design practice should limit the maximum continuous current through the main terminals to 75% of the component rating. Other ways to ensure long life for a power discrete semiconductor are proper heat sinking and selection of voltage ratings for worst case conditions. Overheating, overvoltage (including dv/dt), and surge currents are the main killers of semiconductors. Correct mounting, soldering, and forming of the leads also help protect against component damage.

**Environmental Specifications**

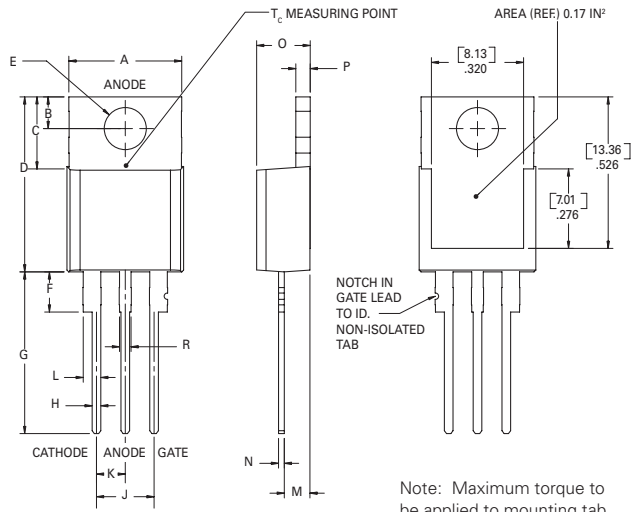
Test	Specifications and Conditions
<b>AC Blocking</b>	MIL-STD-750, M-1040, Cond A Applied Peak AC voltage @ 125°C for 1008 hours
<b>Temperature Cycling</b>	JESD22 A-104 Appendix 6 -55°C to 150°C, 15-minute dwell, 1000 cycles
<b>Autoclave (Pressure Cooker Test)</b>	EIA/JEDEC: JESD22-A102 121°C, 100%RH, 15psig, 96hours
<b>Biased Temperature &amp; Humidity</b>	EIA / JEDEC, JESD22-A101 1008 hours; 320V - DC: 85°C; 85% rel humidity
<b>Intermittent Operational Life</b>	T <sub>A</sub> =25°C, ΔT <sub>J</sub> ≥ 100°C, 1008hrs
<b>Resistance to Solder Heat</b>	JESD22 A-111: 260°C, 10 seconds
<b>Solderability</b>	ANSI/J-STD-002, category 3, Test A

**Dimensions –TO- 263AB (N-package) – D<sup>2</sup>-Pak Surface Mount**



Dimension	Inches		Millimeters	
	Min	Max	Min	Max
A	0.360	0.370	9.14	9.40
B	0.380	0.420	9.65	10.67
C	0.178	0.188	4.52	4.78
D	0.025	0.035	0.64	0.89
E	0.045	0.060	1.14	1.52
F	0.060	0.075	1.52	1.91
G	0.095	0.105	2.41	2.67
H	0.092	0.102	2.34	2.59
J	0.018	0.024	0.46	0.61
K	0.090	0.110	2.29	2.79
S	0.590	0.625	14.99	15.88
V	0.035	0.045	0.89	1.14
U	0.002	0.010	0.05	0.25
W	0.040	0.070	1.016	1.78

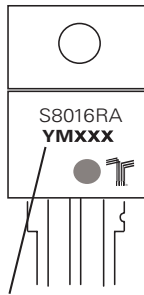
**Dimensions — TO-220AB (R-Package) — Non-Isolated Mounting Tab Common with Center Lead**



Dimension	Inches		Millimeters	
	Min	Max	Min	Max
A	0.380	0.420	9.65	10.67
B	0.105	0.115	2.67	2.92
C	0.230	0.250	5.84	6.35
D	0.590	0.620	14.99	15.75
E	0.142	0.147	3.61	3.73
F	0.110	0.130	2.79	3.30
G	0.540	0.575	13.72	14.61
H	0.025	0.035	0.64	0.89
J	0.195	0.205	4.95	5.21
K	0.095	0.105	2.41	2.67
L	0.060	0.075	1.52	1.91
M	0.085	0.095	2.16	2.41
N	0.018	0.024	0.46	0.61
O	0.178	0.188	4.52	4.78
P	0.045	0.060	1.14	1.52
R	0.038	0.048	0.97	1.22

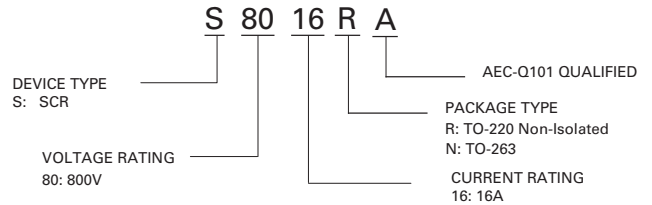
**Part Marking System**

TO-220 AB - (R Package)  
TO-263 (N Package)



**Date Code Marking**  
Y: Year Code  
M: Month Code  
XXX: Lot Trace Code

**Part Numbering System**

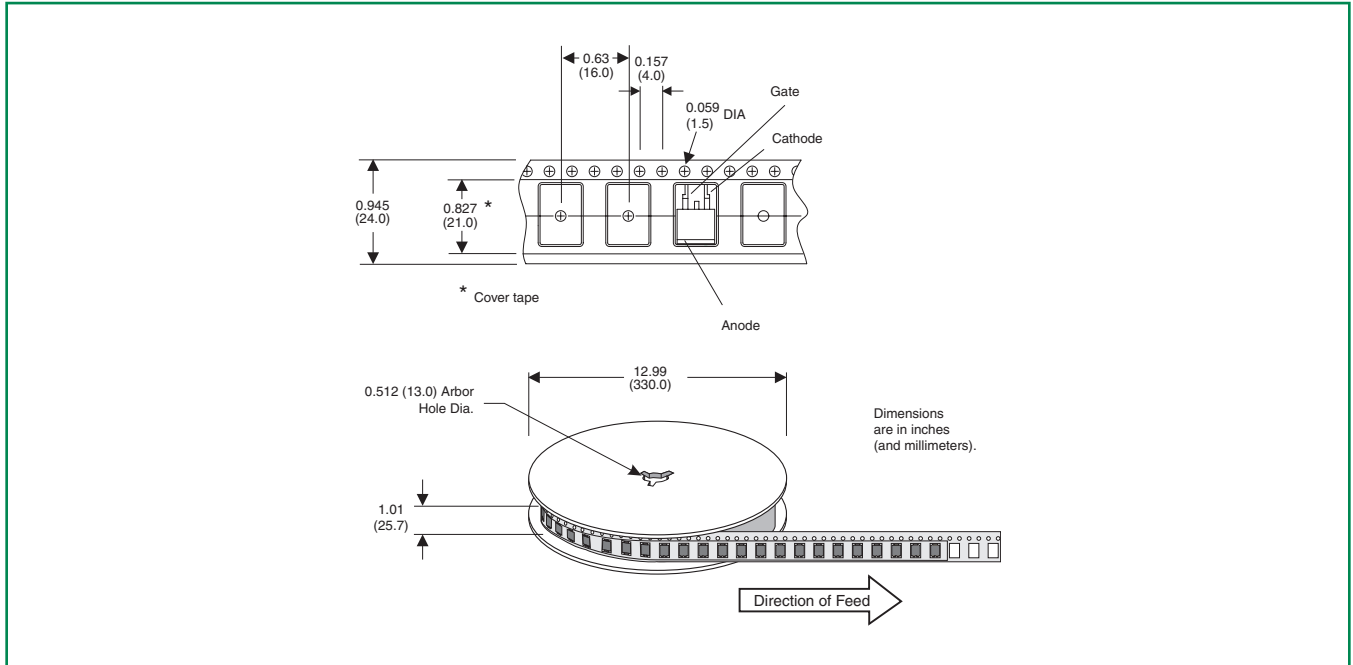


**Packing Options**

Part Number	Marking	Weight	Packing Mode	Base Quantity	Package
S8016RATP	S8016RA	1.6g	Tube	500 (50 per tube)	TO-220R
S8016NARP	S8016NA	1.6g	Embossed Carrier	500	TO-263

**TO-263 Embossed Carrier Reel Pack (RP) Specifications**

**Meets all EIA-481-2 Standards**



Компания «Океан Электроники» предлагает заключение долгосрочных отношений при поставках импортных электронных компонентов на взаимовыгодных условиях!

Наши преимущества:

- Поставка оригинальных импортных электронных компонентов напрямую с производств Америки, Европы и Азии, а так же с крупнейших складов мира;
- Широкая линейка поставок активных и пассивных импортных электронных компонентов (более 30 млн. наименований);
- Поставка сложных, дефицитных, либо снятых с производства позиций;
- Оперативные сроки поставки под заказ (от 5 рабочих дней);
- Экспресс доставка в любую точку России;
- Помощь Конструкторского Отдела и консультации квалифицированных инженеров;
- Техническая поддержка проекта, помощь в подборе аналогов, поставка прототипов;
- Поставка электронных компонентов под контролем ВП;
- Система менеджмента качества сертифицирована по Международному стандарту ISO 9001;
- При необходимости вся продукция военного и аэрокосмического назначения проходит испытания и сертификацию в лаборатории (по согласованию с заказчиком);
- Поставка специализированных компонентов военного и аэрокосмического уровня качества (Xilinx, Altera, Analog Devices, Intersil, Interpoint, Microsemi, Actel, Aeroflex, Peregrine, VPT, Syfer, Eurofarad, Texas Instruments, MS Kennedy, Miteq, Cobham, E2V, MA-COM, Hittite, Mini-Circuits, General Dynamics и др.);

Компания «Океан Электроники» является официальным дистрибьютором и эксклюзивным представителем в России одного из крупнейших производителей разъемов военного и аэрокосмического назначения «JONHON», а так же официальным дистрибьютором и эксклюзивным представителем в России производителя высокотехнологичных и надежных решений для передачи СВЧ сигналов «FORSTAR».



## JONHON

«JONHON» (основан в 1970 г.)

Разъемы специального, военного и аэрокосмического назначения:

(Применяются в военной, авиационной, аэрокосмической, морской, железнодорожной, горно- и нефтедобывающей отраслях промышленности)

«FORSTAR» (основан в 1998 г.)

ВЧ соединители, коаксиальные кабели, кабельные сборки и микроволновые компоненты:

(Применяются в телекоммуникациях гражданского и специального назначения, в средствах связи, РЛС, а так же военной, авиационной и аэрокосмической отраслях промышленности).



Телефон: 8 (812) 309-75-97 (многоканальный)

Факс: 8 (812) 320-03-32

Электронная почта: [ocean@oceanchips.ru](mailto:ocean@oceanchips.ru)

Web: <http://oceanchips.ru/>

Адрес: 198099, г. Санкт-Петербург, ул. Калинина, д. 2, корп. 4, лит. А