

Features

- ± 60 ps Peak-Peak Period Jitter
- Wide frequency range
 - 1 MHz to 125 MHz
- Low frequency tolerance
 - ± 30 ppm (-20°C to 70°C only)
 - ± 50 ppm or ± 100 ppm
- Operating voltage
 - 1.8V or 2.5 or 3.3 V
 - 2.25V to 3.6V (contact factory)
- Operating temperature range:
 - Industrial, -40°C to 85°C
 - Extended Commercial, -20°C to 70°C
- Small footprint
 - 2.5 x 2.0 x 0.85 mm
 - 3.2 x 2.5 x 0.85 mm
 - 5.0 x 3.2 x 0.85 mm
 - 7.0 x 5.0 x 0.85 mm
- All packages are Pb-free and ROHs compliant (QFN SMD)
- Ultra-reliable start up and greater immunity from interference

- High drive option: 30pF load (contact factory)

Benefits

- No crystal or capacitors required
- Eliminates crystal qualification time
- 50% + board saving space
- More cost effective than Quartz oscillators, Quartz crystals and Clock ICs.
- Completely quartz-free

Applications

- Consumer Electronics
- Set Top Box, HDTV, DVR
- Office Automation: Scanners, Printers, Copiers
- Automotive Applications
- Industrial Applications: Interface Controllers, Graphics Cards.

Block Diagram

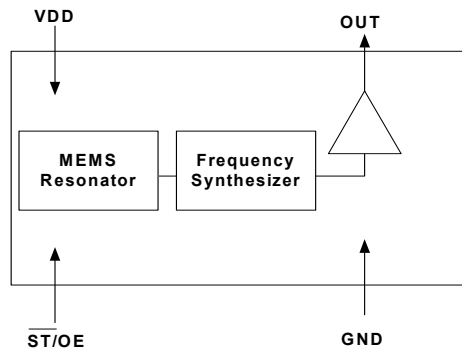

Pinout

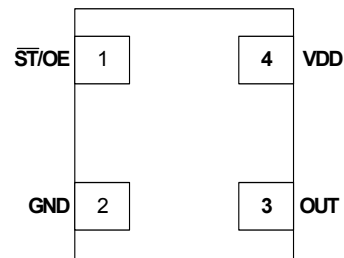

Pin Description

Pin No.	Name	Pin Description
1	ST/OE	Standby/ Output Enable
2	GND	Connect to Ground
3	OUT	1 to 125 MHz Programmed Clock output
4	VDD	Connect to 1.8V or 2.5V or 3.3V

Pin1

Pin #1 Functionality
OE
H or Open; specified frequency output
L: output is high impedance
ST
H or Open; specified frequency output
L: output is low level (weak pull down) oscillation stops

Description

The SiT8002 oscillator family is composed of the world's smallest, high-performance programmable oscillators. The SiT8002 is suitable for use in clock generation for consumer, portable, industrial, automotive, and computation applications.

This oscillator family is packaged in standard low-cost plastic QFN-type IC packages with footprints that match common quartz surface mount products.

MEMS resonators are 1000x smaller by volume than quartz resonators and are built in high volume CMOS fabs instead of small custom manufacturing facilities. Due to their small size, massive lot sizes, and simpler manufacturing processes

MEMS oscillators are inherently more reliable, have more consistent performance and are always in stock.

The SiT8002, by eliminating the quartz crystals, has improved immunity to the environmental effects of vibration, shock, strain, and humidity.

To order samples, go to www.sitime.com and click on Request Sample" link.

Absolute Maximum Ratings

Attempted operation outside the absolute maximum ratings of the part may cause permanent damage to the part. Actual performance of the IC is only guaranteed within the operational specifications not absolute maximum ratings.

Absolute Maximum Table

Parameter	Min.	Max.	Unit
Storage Temperature	-65	150	°C
VDD	-0.5	+3.65	V
Electrostatic Discharge		6000	V
Theta JA (with copper plane on VDD and GND)	–	75	°C/W
Theta JC (with PCB traces of 0.010 inch to all pins)	–	24	°C/W
Soldering Temperature (follow standard Pb free soldering guidelines)		260	°C
Number of Program Writes		1	NA
Program Retention over -40 to 125C, Process, VDD (0 to 3.6V)		1,000+	years

Operating Conditions

Parameter	Min.	Typ.	Max.	Unit
Supply Voltages, VDD ^[1]	2.97	3.3	3.63	V
	2.25	2.5	2.75	V
	1.7	1.8	1.9	V
Extended Commercial Operating Temperature	-20	-	70	°C
Industrial Operating Temperature	-40	-	85	°C
Maximum Load Capacitance ^[2]	-	-	15	pF
VDD Ramp Time	0	-	200	ms

Environmental Compliance

Parameter	Condition/Test Method
Mechanical Shock	MIL-STD-883F, Method 2002
Mechanical Vibration	MIL-STD-883F, Method 2007
Temperature Cycle	JESD22, Method A104
Solderability	MIL-STD-883F, Method 2003
Moisture Sensibility Level	MSL1 @ 260°C

Notes:

- The 2.5V device can operate from 2.25V to 3.63V with higher output drive, however, the data sheet parameters cannot be guaranteed. Please contact factory for this option.
- The output driver strength can be programmed to drive up to 30pF load. Please contact factory for this option.

DC Electrical Specifications

@VDD = 3.3V ±10%, -40 to 85°C

Parameter	Condition	Min.	Typ.	Max.	Unit
Output Voltage High	IOH = -9 mA	90	-	-	%Vdd
Output Voltage Low	IOL = 9 mA	-	-	10	%Vdd
Input Voltage High	Pin 1	70	-	-	%Vdd
Input Voltage Low	Pin 1	-	-	30	%Vdd
Operating Current	Output frequency = 65 MHz, 15 pF load	-	-	22	mA
Standby Current	Output is weakly pulled down, \overline{ST} = GND	-	30	50	uA
Power Up Time	Time from minimum power supply voltage	-	12	50	ms

@VDD = 2.5V ±10%, -40 to 85°C

Parameter	Condition	Min.	Typ.	Max.	Unit
Output Voltage High	IOH = -7 mA	90	-	-	%Vdd
Output Voltage Low	IOL = 7 mA	-	-	10	%Vdd
Input Voltage High	Pin 1	70	-	-	%Vdd
Input Voltage Low	Pin 1	-	-	30	%Vdd
Operating Current	Output frequency = 65 MHz, 15 pF load	-	-	22	mA
Standby Current	Output is weakly pulled down, \overline{ST} = GND	-	30	50	uA
Power Up Time	Time from minimum power supply voltage	-	12	50	ms

@VDD = 1.8V ±5%, -40 to 85°C

Parameter	Condition	Min.	Typ.	Max.	Unit
Output Voltage High	IOH = -5 mA	90	-	-	%Vdd
Output Voltage Low	IOL = 5 mA	-	-	10	%Vdd
Input Voltage High	Pin 1	70	-	-	%Vdd
Input Voltage Low	Pin 1	-	-	30	%Vdd
Operating Current	Output frequency = 65 MHz, 15 pF load	-	-	19	mA
Standby Current	Output is weakly pulled down, \overline{ST} = GND	-	30	50	uA
Power Up Time	Time from minimum power supply voltage	-	12	50	ms

AC Electrical Specifications

@VDD = 3.3V ±10%, -40 to 85°C

Parameter	Condition	Min.	Typ.	Max.	Unit
Clock Output Frequency		1	-	125	MHz
Frequency Tolerance ^[3]	Inclusive of initial tolerance, operating temperature, rated power supply voltage change, load change, aging, shock and vibration	-30	-	+30	ppm
		-50	-	+50	ppm
		-100	-	+100	ppm
Aging	First year	-	-	1	ppm
Clock Output Duty Cycle	Output frequency= 1 MHz to 125 MHz	45	-	55	%
Clock Output Rise Time	15 pF Load, 20% to 80% VDD	-	1.0	2.0	ns
Clock Output Fall Time	15 pF Load, 80% to 20% VDD	-	1.0	2.0	ns
Pk-pk Period Jitter	Output frequency = 24 MHz	-	-	±98	ps
	Output frequency = 100 MHz	-	-	±60	ps

@VDD = 2.5V ±10%, -40 to 85°C

Parameter	Condition	Min.	Typ.	Max.	Unit
Clock Output Frequency		1	-	125	MHz
Frequency Tolerance ^[3]	Inclusive of initial tolerance, operating temperature, rated power supply voltage change, load change, aging, shock and vibration	-30	-	+30	ppm
		-50	-	+50	ppm
		-100	-	+100	ppm
Aging	First year	-	-	1	ppm
Clock Output Duty Cycle	Output frequency= 1MHz to 125MHz	45	-	55	%
Clock Output Rise Time	15 pF Load, 20% to 80% VDD	-	1.0	2.0	ns
Clock Output Fall Time	15 pF Load, 80% to 20% VDD	-	1.0	2.0	ns
Pk-pk Period Jitter	Output frequency = 24 MHz	-	-	±130	ps
	Output frequency = 100 MHz	-	-	±60	ps

@VDD = 1.8V ±5%, -40 to 85°C

Parameter	Condition	Min.	Typ.	Max.	Unit
Clock Output Frequency		1	-	125	MHz
Frequency Tolerance ^[3]	Inclusive of initial tolerance, operating temperature, rated power supply voltage change, load change, aging, shock and vibration	-50	-	+50	ppm
		-100	-	+100	ppm
Aging	First year	-	-	1	ppm
Clock Output Duty Cycle	Output frequency= 1 MHz to 65MHz	45	-	55	%
	Output frequency= 65 MHz to 125MHz	40	-	60	%
Clock Output Rise Time	15 pF Load, 20% to 80% VDD	-	1.0	2.0	ns
Clock Output Fall Time	15 pF Load, 80% to 20% VDD	-	1.0	2.0	ns
Pk-pk Period Jitter	Output frequency = 24 MHz	-	-	±185	ps
	Output frequency = 100 MHz	-	-	±100	ps

Notes:

3. ±30 ppm is available only over extended commercial temperature range from -20 °C to +70 °C and VDD=2.5V or 3.3V.

Ordering Information

SiT8002AC - 14 - 33E - 123.12345T

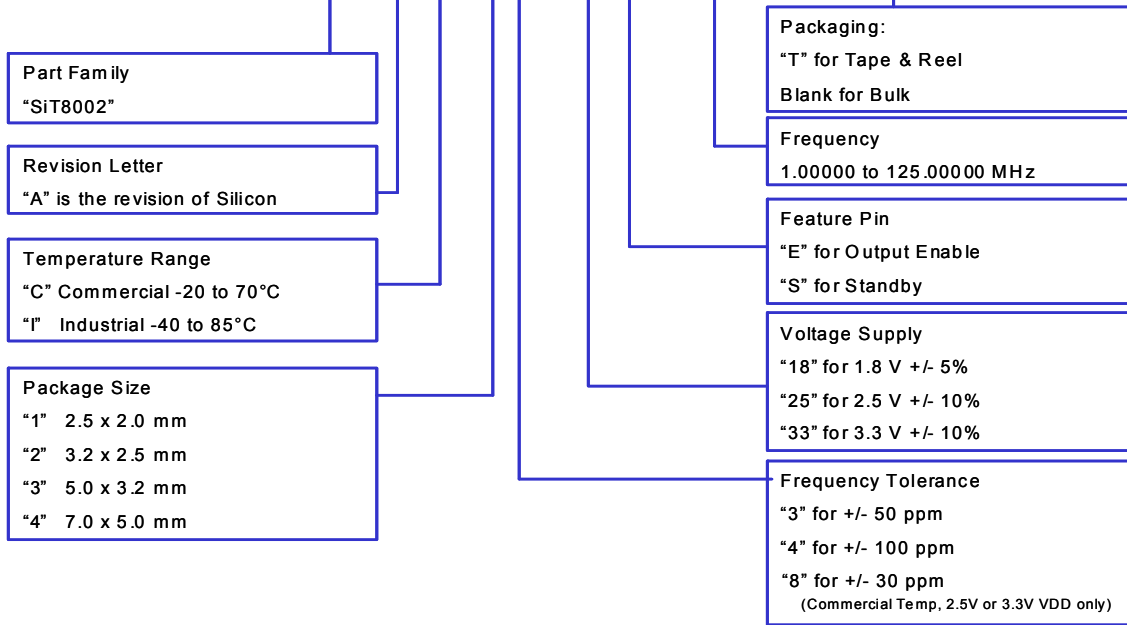

Package Information [4]

Dimension (mm)

2.5 x 2.0 x 0.85mm

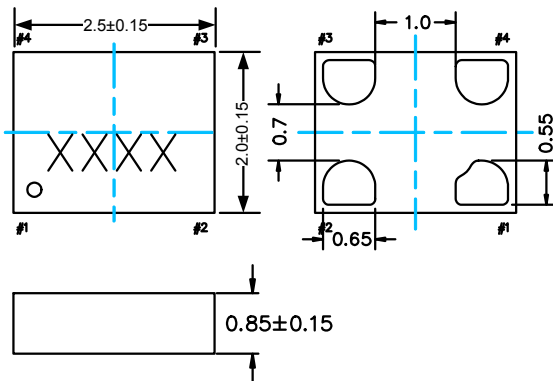

Land Pattern (recommended) (mm)^[5]

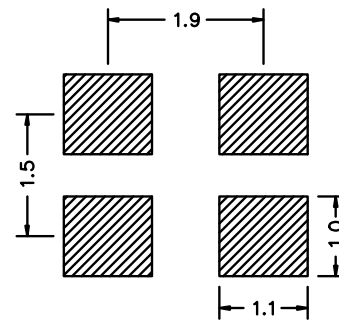

Package Information (continued)^[4]

Dimension (mm)

Land Pattern (recommended) (mm)^[5]

3.2 x 2.5 x 0.85mm

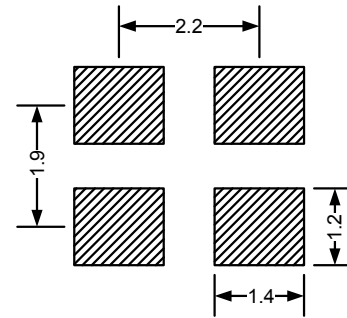
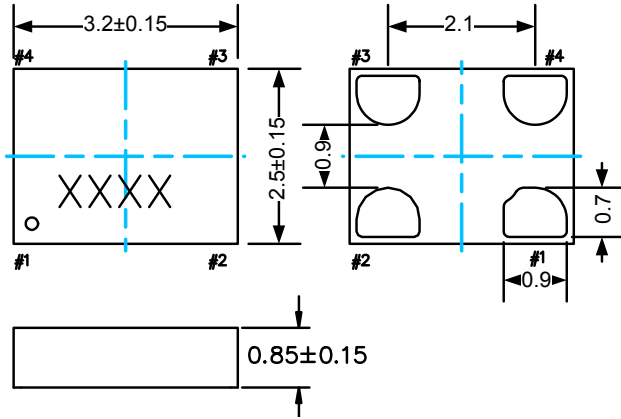

5.0 x 3.2 x 0.85mm

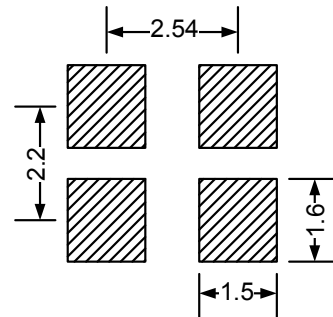
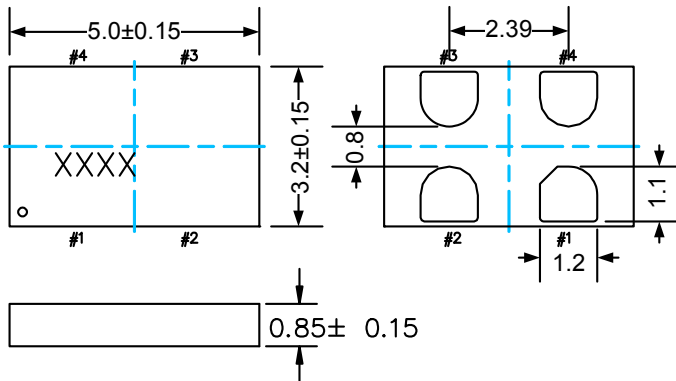

7.0 x 5.0 x 0.85mm

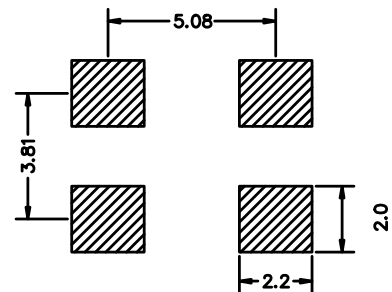
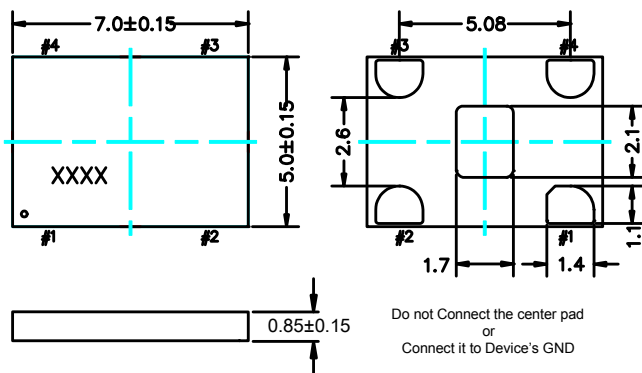

Do not Connect the center pad
or
Connect it to Device's GND

Note:

- 4. xxxx top marking denotes manufacturing lot number.
- 5. A capacitor of value 0.1µF between VDD and GND is recommended.

© SiTime Corporation 2008. The information contained herein is subject to change at any time without notice. SiTime assumes no responsibility or liability for any loss, damage or defect of a Product which is caused in whole or in part by (i) use of any circuitry other than circuitry embodied in a SiTime product, (ii) misuse or abuse including static discharge, neglect or accident, (iii) unauthorized modification or repairs which have been soldered or altered during assembly and are not capable of being tested by SiTime under its normal test conditions, or (iv) improper installation, storage, handling, warehousing or transportation, or (v) being subjected to unusual physical, thermal, or electrical stress.

Disclaimer: sitime makes no warranty of any kind, express or implied, with regard to this material, and specifically disclaims any and all express or implied warranties, either in fact or by operation of law, statutory or otherwise, including the implied warranties of merchantability and fitness for use or a particular purpose, and any implied warranty arising from course of dealing or usage of trade, as well as any common-law duties relating to accuracy or lack of negligence, with respect to this material, any sitime product and any product documentation. products sold by sitime are not suitable or intended to be used in a life support application or component, to operate nuclear facilities, or in other mission critical applications where human life may be involved or at stake. all sales are made conditioned upon compliance with the critical uses policy set forth below.

CRITICAL USE EXCLUSION POLICY
BUYER AGREES NOT TO USE SITIME'S PRODUCTS FOR ANY APPLICATION OR IN ANY COMPONENTS USED IN LIFE SUPPORT DEVICES OR TO OPERATE NUCLEAR FACILITIES OR FOR USE IN OTHER MISSION-CRITICAL APPLICATIONS OR COMPONENTS WHERE HUMAN LIFE OR PROPERTY MAY BE AT STAKE.

SiTime owns all rights, title and interest to the intellectual property related to SiTime's products, including any software, firmware, copyright, patent, or trademark. The sale of SiTime products does not convey or imply any license under patent or other rights. SiTime retains the copyright and trademark rights in all documents, catalogs and plans supplied pursuant to or ancillary to the sale of products or services by SiTime. Unless otherwise agreed to in writing by SiTime, any reproduction, modification, translation, compilation, or representation of this material shall be strictly prohibited.

Компания «Океан Электроники» предлагает заключение долгосрочных отношений при поставках импортных электронных компонентов на взаимовыгодных условиях!

Наши преимущества:

- Поставка оригинальных импортных электронных компонентов напрямую с производств Америки, Европы и Азии, а так же с крупнейших складов мира;
- Широкая линейка поставок активных и пассивных импортных электронных компонентов (более 30 млн. наименований);
- Поставка сложных, дефицитных, либо снятых с производства позиций;
- Оперативные сроки поставки под заказ (от 5 рабочих дней);
- Экспресс доставка в любую точку России;
- Помощь Конструкторского Отдела и консультации квалифицированных инженеров;
- Техническая поддержка проекта, помощь в подборе аналогов, поставка прототипов;
- Поставка электронных компонентов под контролем ВП;
- Система менеджмента качества сертифицирована по Международному стандарту ISO 9001;
- При необходимости вся продукция военного и аэрокосмического назначения проходит испытания и сертификацию в лаборатории (по согласованию с заказчиком);
- Поставка специализированных компонентов военного и аэрокосмического уровня качества (Xilinx, Altera, Analog Devices, Intersil, Interpoint, Microsemi, Actel, Aeroflex, Peregrine, VPT, Syfer, Eurofarad, Texas Instruments, MS Kennedy, Miteq, Cobham, E2V, MA-COM, Hittite, Mini-Circuits, General Dynamics и др.);

Компания «Океан Электроники» является официальным дистрибьютором и эксклюзивным представителем в России одного из крупнейших производителей разъемов военного и аэрокосмического назначения «**JONHON**», а так же официальным дистрибьютором и эксклюзивным представителем в России производителя высокотехнологичных и надежных решений для передачи СВЧ сигналов «**FORSTAR**».



JONHON

«**JONHON**» (основан в 1970 г.)

Разъемы специального, военного и аэрокосмического назначения:

(Применяются в военной, авиационной, аэрокосмической, морской, железнодорожной, горно- и нефтедобывающей отраслях промышленности)

«**FORSTAR**» (основан в 1998 г.)

ВЧ соединители, коаксиальные кабели, кабельные сборки и микроволновые компоненты:

(Применяются в телекоммуникациях гражданского и специального назначения, в средствах связи, РЛС, а так же военной, авиационной и аэрокосмической отраслях промышленности).



Телефон: 8 (812) 309-75-97 (многоканальный)

Факс: 8 (812) 320-03-32

Электронная почта: ocean@oceanchips.ru

Web: <http://oceanchips.ru/>

Адрес: 198099, г. Санкт-Петербург, ул. Калинина, д. 2, корп. 4, лит. А