



Features

- 2.5A Maximum Peak Output Current
- 20ns Typical Pulse Width Distortion
- 10kV/ μ s Minimum Common Mode Rejection (CMR) at 1500V_{CM}
- Wide Operating Voltage Range: 10V to 20V
- Under Voltage Lockout with Hysteresis
- 3750V_{rms} Input to Output Isolation
- Wide Temperature Range: -40°C to +100°C
- 200ns Maximum Propagation Delay Over Temperature Range

Applications

- Isolated Power MOSFET Gate Drive
- Switch Mode Power Supplies
- Industrial Inverters
- Motor Drivers

Description

The IX3180 is a high speed MOSFET gate drive optocoupler. It consists of an input infrared LED that is optically coupled to an integrated power gate driver that is capable of sourcing and sinking 2.5A of peak current. The IX3180 is ideally suited for high frequency driving of power MOSFETs used in high performance DC/DC converters, motor control inverter applications, and high performance switching power supplies.

The IX3180 is available in an 8-pin DIP package and an 8-pin surface mount package.

Approvals

- UL Recognized Component: File E76270

Ordering Information

Part	Description
IX3180G	8-Pin DIP Package (50/Tube)
IX3180GS	8-Pin Surface Mount (50/Tube)
IX3180GSTR	8-Pin Surface Mount Tape & Reel (1000/Reel)

Figure 1. IX3180 Block Diagram



Note: A 0.1 μ F bypass capacitor must be connected between pins 5 & 8.



1. Specifications	3
1.1 Package Pinout	3
1.2 Pin Description	3
1.3 Absolute Maximum Ratings @ 25°C	3
1.4 Recommended Operating Conditions	4
1.5 Electrical Specifications (DC)	4
1.6 Switching Characteristics (AC)	5
1.7 Package Characteristics	5
2. Performance Data	6
3. Test Circuits	8
4. Manufacturing Information	9
4.1 Moisture Sensitivity	9
4.2 ESD Sensitivity	9
4.3 Soldering Profile	9
4.4 Board Wash	9
4.5 Package Mechanical Dimensions	10
4.5.1 IX3180G 8-Pin DIP	10
4.5.2 IX3180GS 8-Pin Surface Mount	10
4.5.3 IX3180GSTR Tape & Reel	11

1. Specifications

1.1 Package Pinout

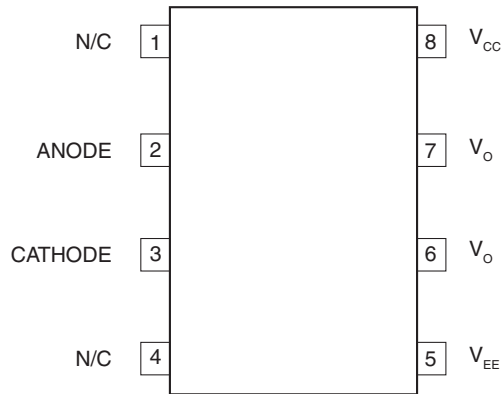

1.2 Pin Description

Pin#	Name	Description
1	N/C	No connection
2	ANODE	Anode of input LED
3	CATHODE	Cathode of input LED
4	N/C	No connection
5	V _{EE}	Negative Supply Voltage
6	V _O	Gate Drive Output
7	V _O	Gate Drive Output
8	V _{CC}	Positive Supply Voltage

1.3 Absolute Maximum Ratings @ 25°C

Parameter	Symbol	Limit	Units
Supply Voltage	V _{CC} - V _{EE}	-0.5 to 25	V
Output Voltage	V _{O(PEAK)}	0 to V _{CC}	V
“High” Peak Output Current ¹	I _{OH(PEAK)}	- 2.5	A
“Low” Peak Output Current ¹	I _{OL(PEAK)}	2.5	A
Reverse Input Voltage	V _R	5	V
Average Input Current	I _{F(AVG)}	20	mA
Peak Transient Input Current (<1μs pulse width, 300pps)	I _{F(TRAN)}	1	A
Input Power Dissipation ²	P _{IN}	70	mW
Total Power Dissipation ³	P _T	800	mW
Isolation Voltage, Input to Output	V _{IO}	3750	V _{rms}
Operating Temperature	T _A	-40 to +100	°C
Storage Temperature	T _{STG}	-55 to +125	°C

Notes:

¹ Maximum pulse width=10μs, maximum duty cycle=0.2%.

² Derate linearly 0.66mW/°C

³ Derate linearly 7.5mW/°C

Absolute maximum ratings are stress ratings. Stresses in excess of these ratings can cause permanent damage to the device. Functional operation of the device at conditions beyond those indicated in the operational sections of this data sheet is not implied.

1.4 Recommended Operating Conditions

Parameter	Symbol	Min	Max	Units
Power Supply Voltage	$V_{CC} - V_{EE}$	10	20	V
Input Current (ON)	$I_{F(on)}$	10	16	mA
Input Voltage (OFF)	$V_{F(off)}$	-3.6	0.8	V
Operating Temperature	T_A	-40	100	°C

1.5 Electrical Specifications (DC)

Over recommended operating conditions unless otherwise specified. Typical values are at $T_A=25^{\circ}\text{C}$.

Parameter	Conditions	Symbol	Min	Typ	Max	Units
High Level Output Current	$V_O=(V_{CC}-4V)^1$	I_{OH}	-0.5	-	-	A
	$V_O=(V_{CC}-10V)^2$		-2	-	-	
Low Level Output Current	$V_O=(V_{EE}+2.5V)^1$	I_{OL}	0.5	-	-	A
	$V_O=(V_{EE}+10V)^2$		2	-	-	
High Level Output Voltage	$I_O=-100\text{mA}$	V_{OH}	$V_{CC}-1$	-	-	V
Low Level Output Voltage	$I_O=100\text{mA}$	V_{OL}	-	-	0.5	V
High Level Supply Current	Output Open, $I_F=10$ to 16mA	I_{CCH}	-	3	6	mA
Low Level Supply Current	Output Open, $V_F=-3$ to $+0.8\text{V}$	I_{CCL}	-	3	6	
Threshold Input Current, Low-to-High	$I_O=0\text{mA}$, $V_O>5\text{V}$	I_{FLH}	-	-	8	mA
Threshold Input Voltage, High-to-Low	-	V_{FHL}	0.8	-	-	V
Input Forward Voltage	$I_F=10\text{mA}$	V_F	1	1.35	1.7	V
Temperature Coefficient of Forward Voltage	$I_F=10\text{mA}$	$\Delta V_F/\Delta T_A$	-	-1.4	-	mV/°C
Input Reverse Breakdown Voltage	$I_R=10\mu\text{A}$	BV_R	5	-	-	V
Input Capacitance	$f=1\text{MHz}$, $V_F=0\text{V}$	C_{IN}	-	30	-	pF
UVLO Threshold	$V_O>5\text{V}$, $I_F=10\text{mA}$	V_{UVLO+}	-	8.7	-	V
		V_{UVLO-}	-	8.1	-	
UVLO Hysteresis	$V_O>5\text{V}$, $I_F=10\text{mA}$	$UVLO_{HYS}$	-	0.6	-	V

¹ Maximum pulse width = $50\mu\text{s}$, maximum duty cycle = 0.5%.

² Maximum pulse width = $10\mu\text{s}$, maximum duty cycle = 0.2%.

See “Test Circuits” on page 8 for more information.

1.6 Switching Characteristics (AC)

Over recommended operating conditions, unless otherwise specified.

Parameter	Conditions	Symbol	Min	Typ	Max	Units
Propagation Delay Time to High Output Level	$R_G=10\Omega, C_G=10nF$ $f=250kHz, \text{Duty Cycle}=50\%$	t_{PLH}	50	85	200	ns
Propagation Delay Time to Low Output Level		t_{PHL}	50	100	200	
Pulse Width Distortion		PWD $ t_{PHL}-t_{PLH} $	-	20	65	
Propagation Delay Difference Between any Two Parts ¹		PDD $(t_{PHL}-t_{PLH})$	-90	-	90	
Rise Time		t_r	-	25	-	
Fall Time		t_f	-	25	-	
UVLO Turn-On Delay		$V_O>5V, I_F=10mA$	$t_{UVLO(on)}$	-	2	
UVLO Turn-Off Delay	$V_O<5V, I_F=10mA$	$t_{UVLO(off)}$	-	0.3	-	
Output High Level Common Mode Transient Immunity	$I_F=10 \text{ to } 16mA, V_{CM}=1500V,$ $V_{CC}=20V, T_A=25^\circ C$	$ CM_H $	10	-	-	kV/ μs
Output Low Level Common Mode Transient Immunity	$V_F=0V, V_{CM}=1500V, V_{CC}=20V,$ $T_A=25^\circ C$	$ CM_L $	10	-	-	

¹ The difference between t_{PHL} and t_{PLH} of any two IX3180 devices operating under the same conditions and temperature.

Figure 2. Timing Waveforms



1.7 Package Characteristics

Parameter	Conditions	Symbol	Rating	Units
Isolation Test Voltage	-	V_{ISO}	3750	V_{rms}
Input-Output Momentary Withstand Voltage	$RH < 50\%, t = 1 \text{ min},$ $T_A = 25^\circ C$	V_{ISO}	3750	V_{rms}
Resistance (Input-Output), Typical	$V_{I-O} = 500V_{DC}$	R_{I-O}	10^{12}	Ω
Capacitance (Input-Output), Typical	$f = 1 \text{ MHz}$	C_{I-O}	0.6	pF

2. Performance Data

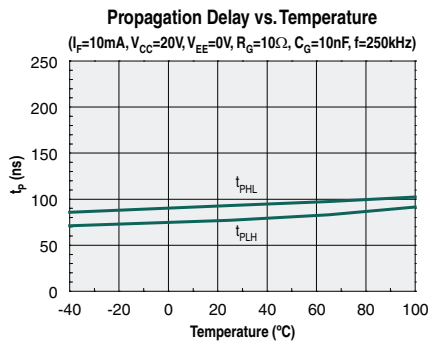
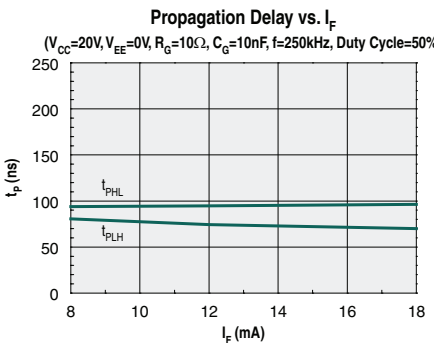
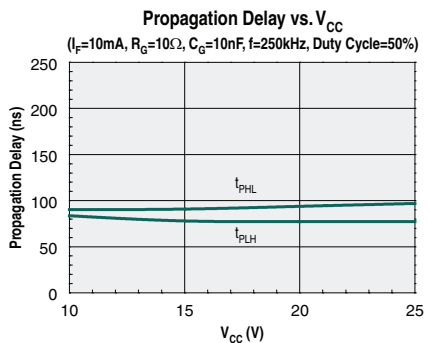
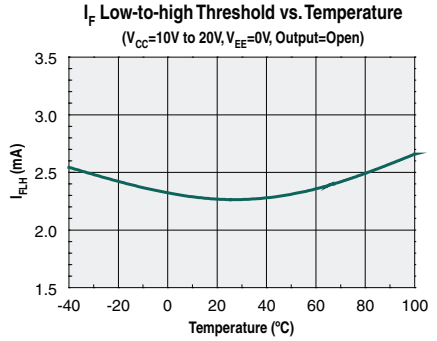
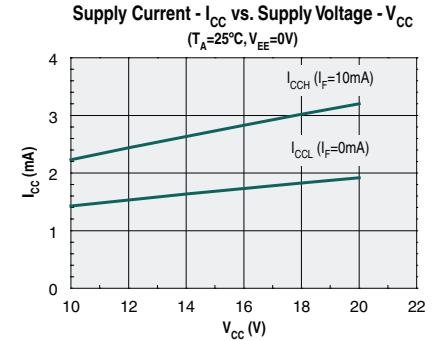
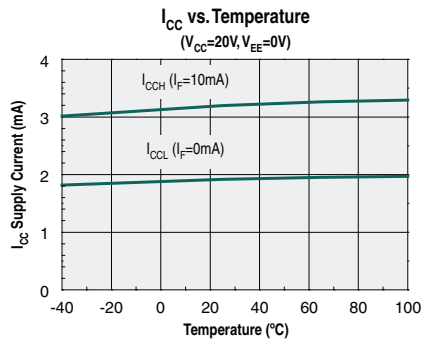
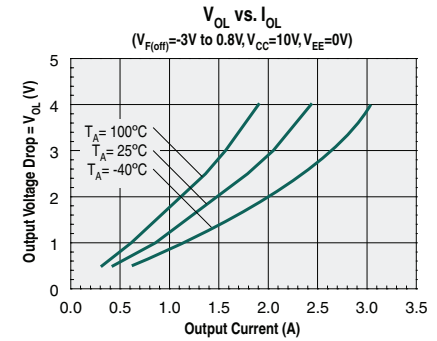
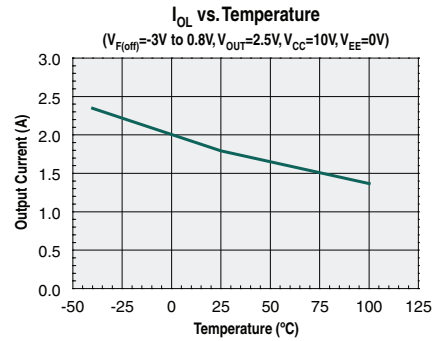
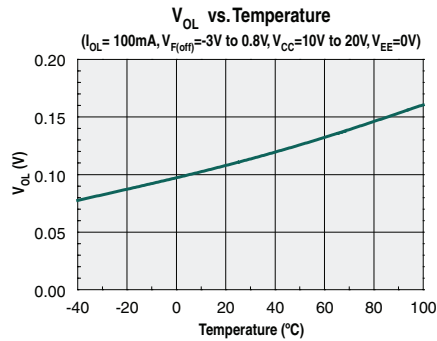
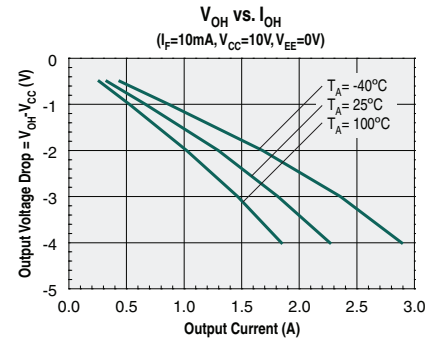
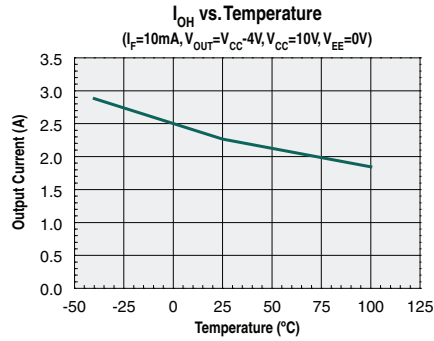
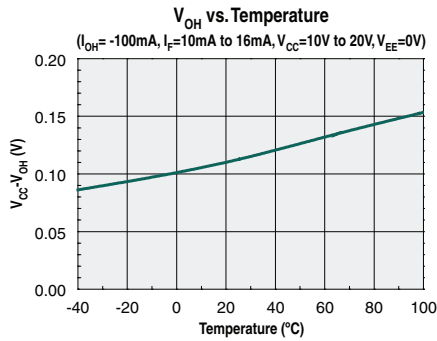

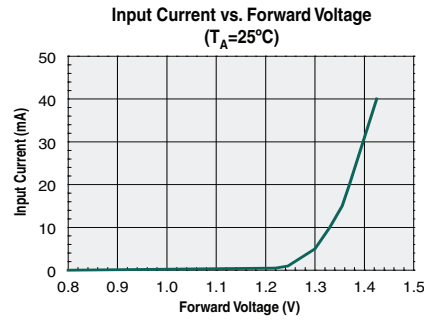
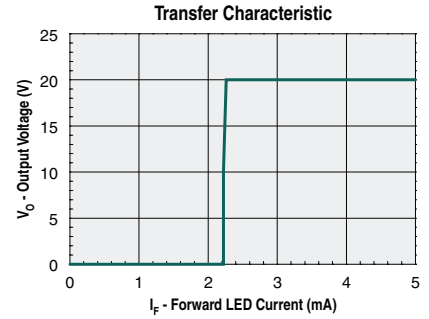

3. Test Circuits

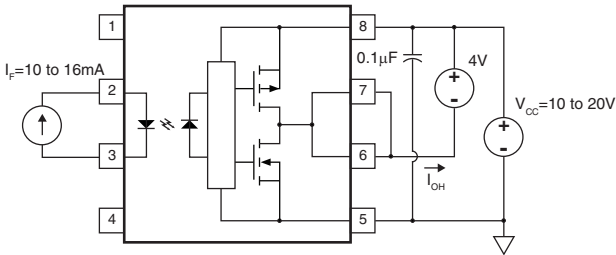

I_{OH} Test Circuit

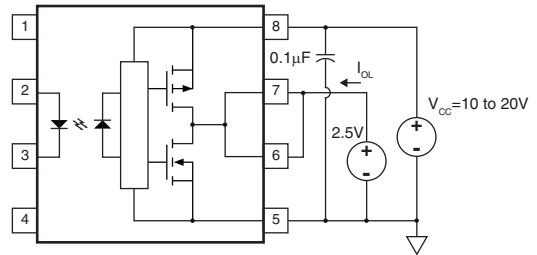

I_{OL} Test Circuit

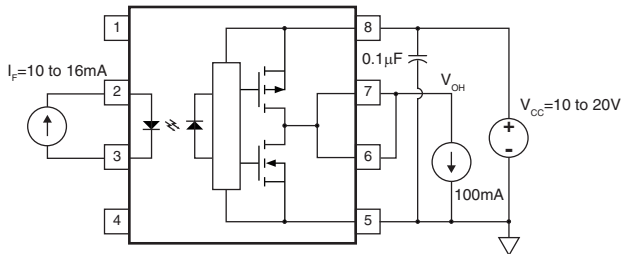

V_{OH} Test Circuit

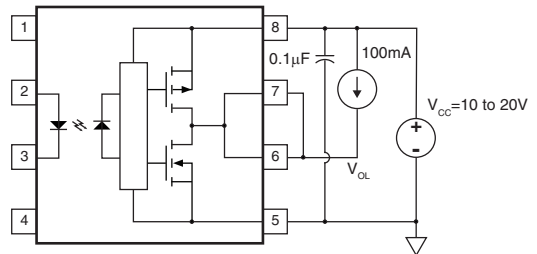

V_{OL} Test Circuit

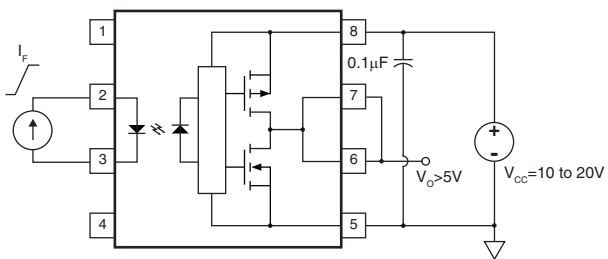

I_{FLH} Test Circuit

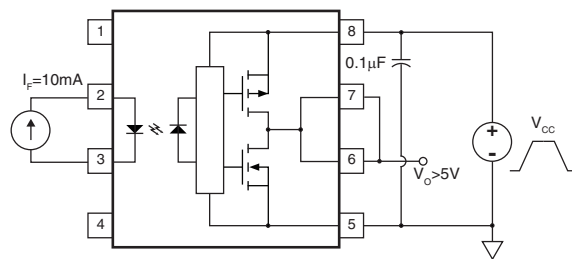

UVLO Test Circuit

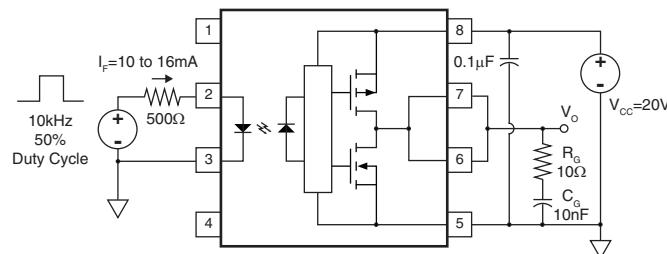

t_{PLH} , t_{PHL} , t_r , t_f Test Circuit

4. Manufacturing Information

4.1 Moisture Sensitivity



All plastic encapsulated semiconductor packages are susceptible to moisture ingress. IXYS Integrated Circuits Division classified all of its plastic encapsulated devices for moisture sensitivity according to the latest version of the joint industry standard, **IPC/JEDEC J-STD-020**, in force at the time of product evaluation. We test all of our products to the maximum conditions set forth in the standard, and guarantee proper operation of our devices when handled according to the limitations and information in that standard as well as to any limitations set forth in the information or standards referenced below.

Failure to adhere to the warnings or limitations as established by the listed specifications could result in reduced product performance, reduction of operable life, and/or reduction of overall reliability.

This product carries a **Moisture Sensitivity Level (MSL) rating** as shown below, and should be handled according to the requirements of the latest version of the joint industry standard **IPC/JEDEC J-STD-033**.

Device	Moisture Sensitivity Level (MSL) Rating
IX3180G / IX3180GS	MSL 1

4.2 ESD Sensitivity



This product is **ESD Sensitive**, and should be handled according to the industry standard **JESD-625**.

4.3 Soldering Profile

This product has a maximum body temperature and time rating as shown below. All other guidelines of **J-STD-020** must be observed.

Device	Maximum Temperature x Time	Maximum Reflow Cycles
IX3180G / IX3180GS	250°C for 30 seconds	3

4.4 Board Wash

IXYS Integrated Circuits Division recommends the use of no-clean flux formulations. However, board washing to remove flux residue is acceptable. Since IXYS Integrated Circuits Division employs the use of silicone coating as an optical waveguide in many of its optically isolated products, the use of a short drying bake may be necessary if a wash is used after solder reflow processes. Chlorine-based or Fluorine-based solvents or fluxes should not be used. Cleaning methods that employ ultrasonic energy should not be used.



4.5 Package Mechanical Dimensions

4.5.1 IX3180G 8-Pin DIP

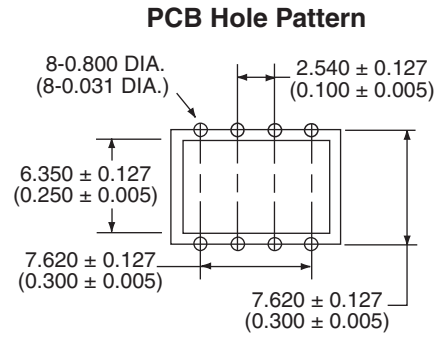
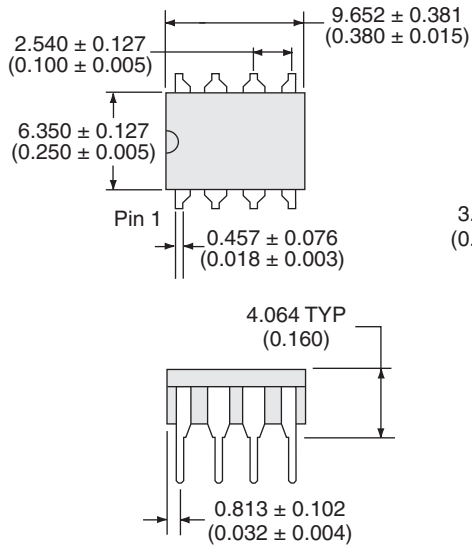

Dimensions
mm
(inches)

4.5.2 IX3180GS 8-Pin Surface Mount

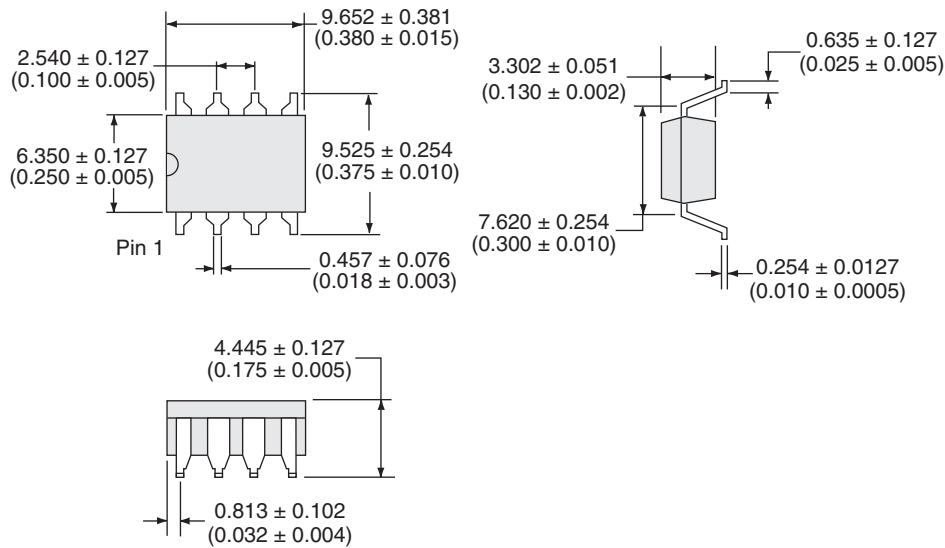

PCB Land Pattern

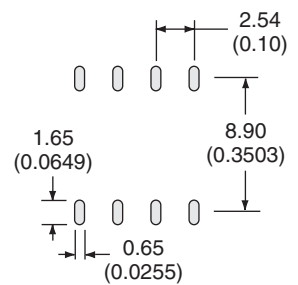

Dimensions
mm
(inches)

4.5.3 IX3180GSTR Tape & Reel

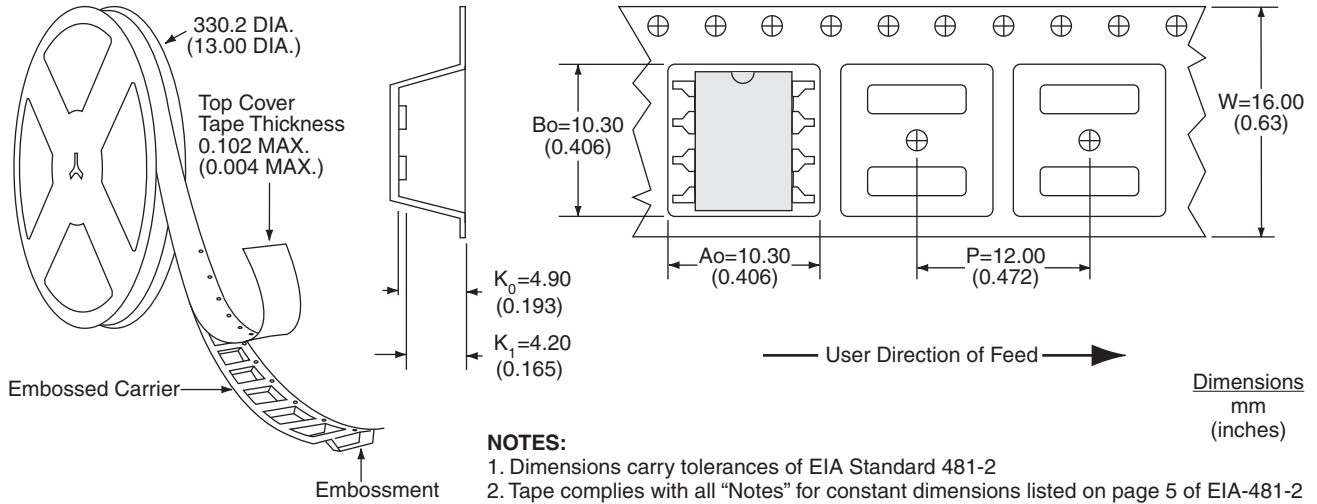

For additional information please visit our website at: www.ixysic.com

IXYS Integrated Circuits Division makes no representations or warranties with respect to the accuracy or completeness of the contents of this publication and reserves the right to make changes to specifications and product descriptions at any time without notice. Neither circuit patent licenses nor indemnity are expressed or implied. Except as set forth in IXYS Integrated Circuits Division's Standard Terms and Conditions of Sale, IXYS Integrated Circuits Division assumes no liability whatsoever, and disclaims any express or implied warranty, relating to its products including, but not limited to, the implied warranty of merchantability, fitness for a particular purpose, or infringement of any intellectual property right.

The products described in this document are not designed, intended, authorized or warranted for use as components in systems intended for surgical implant into the body, or in other applications intended to support or sustain life, or where malfunction of IXYS Integrated Circuits Division's product may result in direct physical harm, injury, or death to a person or severe property or environmental damage. IXYS Integrated Circuits Division reserves the right to discontinue or make changes to its products at any time without notice.

Specification: DS-IX3180-R02
 ©Copyright 2015, IXYS Integrated Circuits Division
 All rights reserved. Printed in USA.
 1/6/2015

Компания «Океан Электроники» предлагает заключение долгосрочных отношений при поставках импортных электронных компонентов на взаимовыгодных условиях!

Наши преимущества:

- Поставка оригинальных импортных электронных компонентов напрямую с производств Америки, Европы и Азии, а так же с крупнейших складов мира;
- Широкая линейка поставок активных и пассивных импортных электронных компонентов (более 30 млн. наименований);
- Поставка сложных, дефицитных, либо снятых с производства позиций;
- Оперативные сроки поставки под заказ (от 5 рабочих дней);
- Экспресс доставка в любую точку России;
- Помощь Конструкторского Отдела и консультации квалифицированных инженеров;
- Техническая поддержка проекта, помощь в подборе аналогов, поставка прототипов;
- Поставка электронных компонентов под контролем ВП;
- Система менеджмента качества сертифицирована по Международному стандарту ISO 9001;
- При необходимости вся продукция военного и аэрокосмического назначения проходит испытания и сертификацию в лаборатории (по согласованию с заказчиком);
- Поставка специализированных компонентов военного и аэрокосмического уровня качества (Xilinx, Altera, Analog Devices, Intersil, Interpoint, Microsemi, Actel, Aeroflex, Peregrine, VPT, Syfer, Eurofarad, Texas Instruments, MS Kennedy, Miteq, Cobham, E2V, MA-COM, Hittite, Mini-Circuits, General Dynamics и др.);

Компания «Океан Электроники» является официальным дистрибьютором и эксклюзивным представителем в России одного из крупнейших производителей разъемов военного и аэрокосмического назначения «JONHON», а так же официальным дистрибьютором и эксклюзивным представителем в России производителя высокотехнологичных и надежных решений для передачи СВЧ сигналов «FORSTAR».



JONHON

«JONHON» (основан в 1970 г.)

Разъемы специального, военного и аэрокосмического назначения:

(Применяются в военной, авиационной, аэрокосмической, морской, железнодорожной, горно- и нефтедобывающей отраслях промышленности)

«FORSTAR» (основан в 1998 г.)

ВЧ соединители, коаксиальные кабели,
кабельные сборки и микроволновые компоненты:

(Применяются в телекоммуникациях гражданского и специального назначения, в средствах связи, РЛС, а так же военной, авиационной и аэрокосмической отраслях промышленности).



Телефон: 8 (812) 309-75-97 (многоканальный)

Факс: 8 (812) 320-03-32

Электронная почта: ocean@oceanchips.ru

Web: <http://oceanchips.ru/>

Адрес: 198099, г. Санкт-Петербург, ул. Калинина, д. 2, корп. 4, лит. А