



Chip varistors

Voltage Protection Devices

Automotive grade

AVR series

AVRM, AVR-M series

| | |
|--------------------|---------------------|
| AVRM1608/AVR-M1608 | JIS 1608 [EIA 0603] |
| AVRM2012/AVR-M2012 | JIS 2012 [EIA 0805] |

AVRL series

| | |
|--------|---------------------|
| AVRL10 | JIS 1005 [EIA 0402] |
| AVRL16 | JIS 1608 [EIA 0603] |

AVRH series

| | |
|--------|---------------------|
| AVRH10 | JIS 1005 [EIA 0402] |
|--------|---------------------|

Chip varistors

Automotive grade

Product compatible with RoHS directive
 Compatible with lead-free solders
 AEC-Q200

Overview of the AVR series

CHARACTERISTICS OF CHIP VARISTOR

Varistors are voltage dependent nonlinear resistive elements with a resistance that decreases rapidly when the voltage is over the constant value.
 Varistors become zener diode of 2 serial connection and equivalent, and does not have polarity.

CURRENT vs. VOLTAGE CHARACTERISTICS

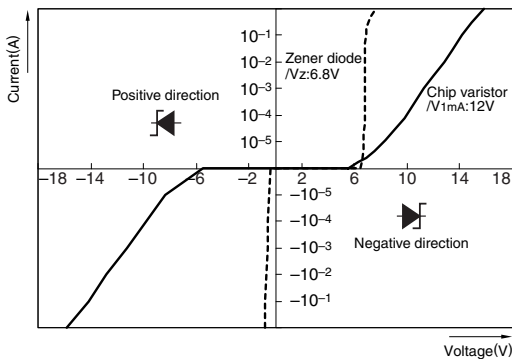

THE EFFECT OF THE VARISTOR

Without varistor

A malfunction and failure of electronic equipment

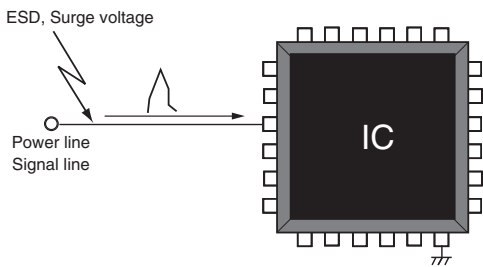

With Varistor

Suppress transient voltage by inserting varistor in a circuit

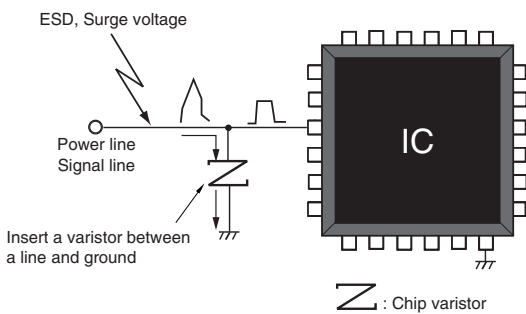

EQUIVALENT CIRCUIT OF CHIP VARISTORS

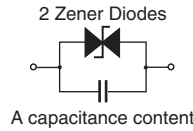

CHIP VARISTORS FEATURE FOR AUTOMOTIVE GRADE

- Reliability characteristics evaluated based on AEC-Q200 condition.
- High ESD withstanding voltage
- Small-sized products are available
- 125°C, 150°C Supported

Figure 1 internal structure of multilayer chip varistors

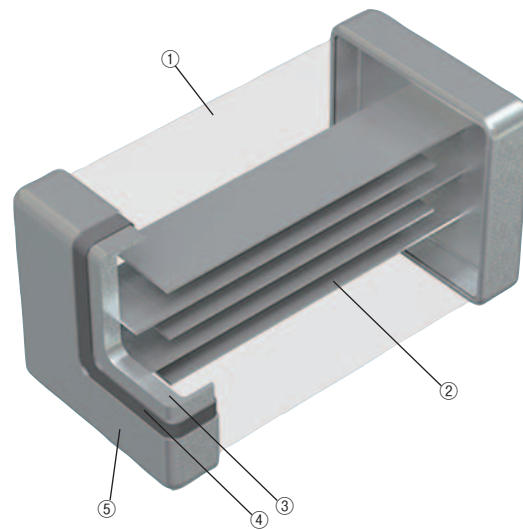

| No. | Name | |
|-----|------------------------|----|
| (1) | Semiconductor ceramic | |
| (2) | Internal electrode(Pd) | |
| (3) | Terminal electrode | Ag |
| (4) | Terminal electrode | Ni |
| (5) | Terminal electrode | Sn |

Chip varistors

Automotive grade

Product compatible with RoHS directive
Compatible with lead-free solders
AEC-Q200

Overview of the AVR series

COMMUNICATION STANDARD, CIRCUIT EXAMPLE AND COMMUNICATION STANDARD

| Type | Dimensions code JIS [EIA] | LIN/CXPI | Classical CAN | CAN/CAN-FD |
|----------------|---------------------------|------------------------------------|------------------------------------|------------------------------------|
| | | | | |
| | | 20 kbps | 1 Mbps | 2-8 Mbps |
| Chip varistors | 1005 [0402] | N/A | AVRH10C270KT150NA8 | AVRH10C270KT150NA8 |
| | 1608 [0603] | AVRM1608C270KT221M | AVR-M1608C270MTAAB | AVR-M1608C270MTABB |
| | 2012 [0805] | N/A | N/A | N/A |

| Type | Dimensions code JIS [EIA] | FlexRay | MOST50 | USB2.0 |
|----------------|---------------------------|------------------------------------|------------------------------------|--------------------------------|
| | | | | |
| | | 10 Mbps | 50 Mbps | 480 Mbps |
| Chip varistors | 1005 [0402] | AVRH10C270KT150NA8 | AVRH10C270KT150NA8 | AVRL101D3R3FTA |
| | 1608 [0603] | AVR-M1608C270MTABB | AVR-M1608C270MTAAB | AVRL161D3R3FTA |
| | 2012 [0805] | N/A | N/A | N/A |

| Type | Dimensions code JIS [EIA] | One-Pair Ethernet 100BASE-T1 | One-Pair Ethernet 1000BASE-T1 | Motors |
|----------------|---------------------------|------------------------------------|--|------------------------------------|
| | | | | |
| | | 100Mbps | 1000Mbps | - |
| Chip varistors | 1005 [0402] | AVRH10C101KT4R7FA8 | AVRH10C101KT1R1NE8 AVRH10C221KT1R5YA8 | N/A |
| | 1608 [0603] | N/A | N/A | AVR-M1608C270KT6AB |
| | 2012 [0805] | N/A | N/A | AVR-M2012C390KT6AB |

Please be sure to request delivery specifications that provide further details on the features and specifications of the products for proper and safe use.
Please note that the contents may change without any prior notice due to reasons such as upgrading.

Chip varistors

Automotive grade

Product compatible with RoHS directive
Compatible with lead-free solders
AEC-Q200

Overview of the AVR series

PART NUMBER CONSTRUCTION

| AVRM | 1608 | C | 390 | K | T | 271 | N | | | | | | |
|-------------|-----------------------|---------|------------------------|------------------------|---|--------------------------------|-----|-----------------|--------|---|-----|---------------------------|-----|
| Series name | L x W dimensions (mm) | | Structure code | Varistor voltage (V) | | Varistor voltage tolerance (%) | | Packaging style | | Capacitance or internal special symbol (pF) | | Capacitance tolerance (%) | |
| AVRM series | 1608 | 1.6×0.8 | C General structure | 390=39×10 ⁰ | | K | ±10 | T | Taping | 271=27×10 ¹ | | K | ±10 |
| | 2012 | 2.0×1.2 | | 220 22 | | M | ±20 | B | Bulk | 221 | 220 | M | ±20 |
| | | | | 270 27 | | N | ±30 | | | 271 | 270 | N | ±30 |
| | | | | 390 39 | | | | | | | | | |

| AVR-M | 1608 | C | 270 | M | T | AAB | | | | |
|--------------|-----------------------|---------|------------------------|------------------------|---|--------------------------------|-----|-----------------|--------|------------------------|
| Series name | L x W dimensions (mm) | | Structure code | Varistor voltage (V) | | Varistor voltage tolerance (%) | | Packaging style | | Company special symbol |
| AVR-M series | 1608 | 1.6×0.8 | C General structure | 270=27×10 ⁰ | | K | ±10 | T | Taping | |
| | 2012 | 2.0×1.2 | | 220 22 | | M | ±20 | B | Bulk | |
| | | | | 270 27 | | N | ±30 | | | |
| | | | | 390 39 | | | | | | |

| AVRL | 10 | 1A | 3R3 | F | T | A | | | | | |
|-------------|-----------------------|---------|----------------------------------|------------------|-----|----------------------------|---|-----------------|---|------------------------|--|
| Series name | L x W dimensions (mm) | | Maximum continuous voltage (Vdc) | Capacitance (pF) | | Capacitance tolerance (pF) | | Packaging style | | Company special symbol | |
| AVRL series | 10 | 1.0×0.5 | 1A | 10 | 3R3 | 3.3 | F | ±1 | T | Taping | |
| L=Low cap | 16 | 1.6×0.8 | | | 6R8 | 6.8 | G | ±2 | B | Bulk | |

| AVRH | 10 | C | 270 | K | T | 150 | N | A | 8 | | | | | | | | |
|--------------------|-----------------------|---------|------------------------|------------------------|---|--------------------------------|-----|-----------------|--------|------------------------|-----------------------|--------------------------------------|---|----------------------------------|---|-----|--|
| Series name | L x W dimensions (mm) | | Structure code | Varistor voltage (V) | | Varistor voltage tolerance (%) | | Packaging style | | Capacitance (pF) | Capacitance tolerance | ESD voltage amount IEC61000-4-2 (kV) | | Operating temperature limit (°C) | | | |
| AVRH series | 10 | 1.0×0.5 | C General structure | 270=27×10 ⁰ | | K | ±10 | T | Taping | 150=15×10 ⁰ | N | ±30% | A | 25 | 8 | 150 | |
| H=High Reliability | | | | 270 27 | | | | B | Bulk | 150 15 | F | ±1pF | | | | | |
| | | | | 390 39 | | | | | | 500 50 | | | | | | | |
| | | | | 101 100 | | | | | | 4R7 4.7 | | | | | | | |

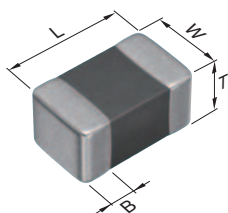

| Shape symbol(JIS) | L | W | T | B |
|-------------------|-----------|-----------|-----------|---------|
| 1005 | 1.00±0.05 | 0.50±0.05 | 0.50±0.05 | 0.1min. |
| 1608 | 1.60±0.1 | 0.80±0.1 | 0.80±0.1 | 0.2min. |
| 2012 | 2.00±0.2 | 1.25±0.2 | 1.00±0.2 | 0.2min. |

⚠ Please be sure to request delivery specifications that provide further details on the features and specifications of the products for proper and safe use.
Please note that the contents may change without any prior notice due to reasons such as upgrading.

Chip varistors

Automotive grade

Product compatible with RoHS directive
Compatible with lead-free solders
AEC-Q200

Overview of the AVR series

OPERATING TEMPERATURE RANGE, PACKAGE QUANTITY, PRODUCT WEIGHT

| Type | Temperature range | | Package quantity (pieces/reel) | Individual weight (mg) |
|--|--------------------------------|-------------------------------|-----------------------------------|---------------------------|
| | Operating temperature* (°C) | Storage temperature** (°C) | | |
| AVRM1005 AVR-M1005 AVRL10 | -40 to +125 | -40 to +125 | 10,000 | 1.2 |
| AVRH10 | | | | |
| AVRM1608 AVRL16 AVR-M1608 AVR-M2012 | -40 to +125 | -40 to +125 | 4,000 | 5 |
| | | | 2,000 | 13 |

* Operating temperature range includes self-temperature rise.

** The storage temperature range is for after the assembly.

TERMINOLOGY

| Item | Unit | Description |
|---|-------------------------|--|
| Varistor voltage (Breakdown voltage) | V _{1mA} (V) | Chip varistor-terminal voltage when DC1mA was flowed |
| Maximum continuous voltage | V _{dc} (V) | DC voltage that is continuously applied between chip varistor terminals Terminal chip varistors leakage current-value: 50μA max Voltage appearing across the varistor when a pulse current (8/20μs ^{*1}) of specified peak value is applied. |
| Clamping voltage | V _{cl} (V) | Voltage between terminal chip varistors of the Specified peak current value of the impulse current(8/20μs ^{*1}) is applied |
| Maximum energy | E (Joule) | When applied specified peak impulse current-value current(10/1000μs ^{*2}) once, maximum energy that electrical property of chip varistors be not deteriorated |
| Maximum peak current | I _p (A) | When applied impulse current(8/20μs ^{*1}) once, maximum current that electrical property of chip varistors be not deteriorated |
| Capacitance | C (pF) | Oscillator frequency 1kHz or 1MHz, Capacitance between chip varistor-terminal in oscillator voltage 1V _{rms} |

*1 8/20μs test waveform

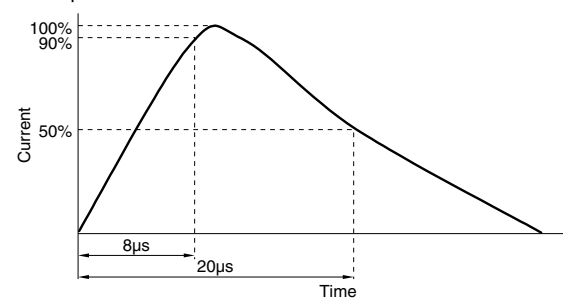

*2 10/1000μs test waveform

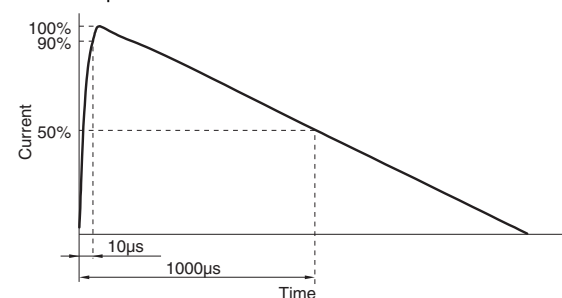

Chip varistors

Automotive grade

Product compatible with RoHS directive

Compatible with lead-free solders

AEC-Q200

AVR series (Automotive grade)

Product characteristics list

■ PRODUCT CHARACTERISTICS LIST

| Item | V1mA (V) | C1kHz * C1MHz (pF) | Vdc DC (V) | Clamping voltage 8/20µs Pulse Vcl (V) | Maximum energy 10/1000µs Pulse E (J) | Maximum peak current 8/20µs Pulse Ip (A) | IEC61000-4-2 (Contact) 150pF/330Ω |
|------------------------------------|------------------|--------------------------|---------------|--|--|---|---|
| AVRL101D3R3FTA | 27(21.6 to 32.4) | 3.3(2.3 to 4.3)* | 20 | 62(0.5A) | 0.01 | 0.5 | 8kV |
| AVRL101D6R8GTA | 27(21.6 to 32.4) | 6.8(4.8 to 8.8)* | 20 | 58(1A) | 0.01 | 1 | 8kV |
| AVRH10C270KT150NA8 | 27(24.0 to 30.0) | 15(10.5 to 19.5) | 19 | 52(2A) | 0.02 | 2 | 25kV |
| AVRH10C270KT350NA8 | 27(24.0 to 30.0) | 35(24.5 to 45.5) | 19 | 52(2A) | 0.02 | 8 | 25kV |
| AVRH10C390KT500NA8 | 39(35.0 to 43.0) | 50(35 to 65) | 28 | 72(2A) | 0.02 | 15 | 25kV |
| AVRH10C101KT4R7FA8 | 100(90 to 110) | 4.7(3.7 to 5.7)* | 70 | 190(1A) | 0.03 | 1 | 25kV |
| AVRH10C101KT1R1NE8 | 110(100 to 120) | 1.1(0.8 to 1.4)* | 70 | 190 (0.3A) | 0.01 | 0.3 | 8kV |
| AVRH10C221KT1R5YA8 | 220 (198 to 242) | 1.5(1.37 to 1.63)* | 70 | 400 (0.5A) | 0.01 | 0.5 | 25kV |
| AVRL161D3R3FTA | 27(21.6 to 32.4) | 3.3(2.3 to 4.3)* | 20 | 62(0.5A) | 0.01 | 0.5 | 8kV |
| AVRL161D6R8GTA | 27(21.6 to 32.4) | 6.8(4.8 to 8.8)* | 20 | 58(1A) | 0.01 | 1 | 8kV |
| AVR-M1608C220KT2AB | 22(19.8 to 24.2) | 210(147 to 273) | 16 | 37(2A) | 0.03 | 10 | 25kV |
| AVR-M1608C220KT6AB | 22(19.8 to 24.2) | 560(392 to 728) | 16 | 34(2A) | 0.10 | 30 | 25kV |
| AVR-M1608C270MTABB | 27(21.6 to 32.4) | 15(10.5 to 19.5) | 17 | 52(2A) | 0.05 | 2 | 25kV |
| AVR-M1608C270MTAAB | 27(21.6 to 32.4) | 30(21 to 39) | 17 | 52(2A) | 0.05 | 2 | 25kV |
| AVR-M1608C270KTACB | 27(24.0 to 30.0) | 60(42 to 78) | 19 | 54(2A) | 0.05 | 10 | 25kV |
| AVRM1608C270KT800M | 27(24.0 to 30.0) | 80(64 to 96) | 19 | 53(2A) | 0.02 | 28 | 25kV |
| AVR-M1608C270KT2AB | 27(24.0 to 30.0) | 160(112 to 208) | 19 | 42(2A) | 0.10 | 20 | 25kV |
| AVRM1608C270KT221M | 27(24.0 to 30.0) | 220(176 to 264) | 19 | 52(2A) | 0.10 | 40 | 25kV |
| AVR-M1608C270KT6AB | 27(24.0 to 30.0) | 430(301 to 339) | 19 | 42(2A) | 0.10 | 48 | 25kV |
| AVRM1608C390KT271N | 39(35.0 to 43.0) | 270(189 to 351) | 28 | 69(2A) | 0.10 | 78 | 25kV |
| AVR-M2012C220KT6AB | 22(19.8 to 24.2) | 800(560 to 1040) | 16 | 38(5A) | 0.30 | 100 | 25kV |
| AVRM2012C330KT801N | 33(29.7 to 36.3) | 800(560 to 1040) | 24 | 59(5A) | 0.50 | 240 | 25kV |
| AVR-M2012C390KT6AB | 39(35.0 to 43.0) | 430(301 to 559) | 28 | 62(5A) | 0.30 | 100 | 25kV |

 Please be sure to request delivery specifications that provide further details on the features and specifications of the products for proper and safe use.
Please note that the contents may change without any prior notice due to reasons such as upgrading.

Chip varistors

Automotive grade

Product compatible with RoHS directive
Compatible with lead-free solders
AEC-Q200

AVR series Electrostatic absorption characteristics

DISCHARGE VOLTAGE WAVEFORM (EXAMPLE)

WITHOUT VARISTOR, WAVEFORM AT VARISTOR INSTALLATION

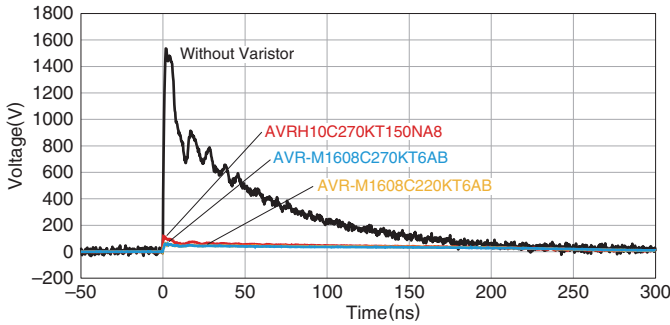

WAVEFORM AT VARISTOR INSTALLATION

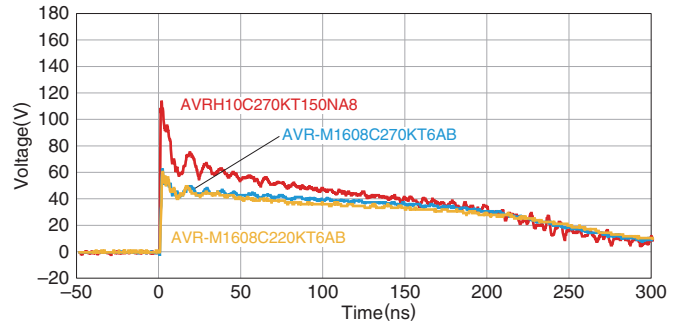

Test conditions

150pF/330Ω (IEC61000-4-2)

Contact discharge, Charged voltage 8kV

TEST CIRCUIT DIAGRAM

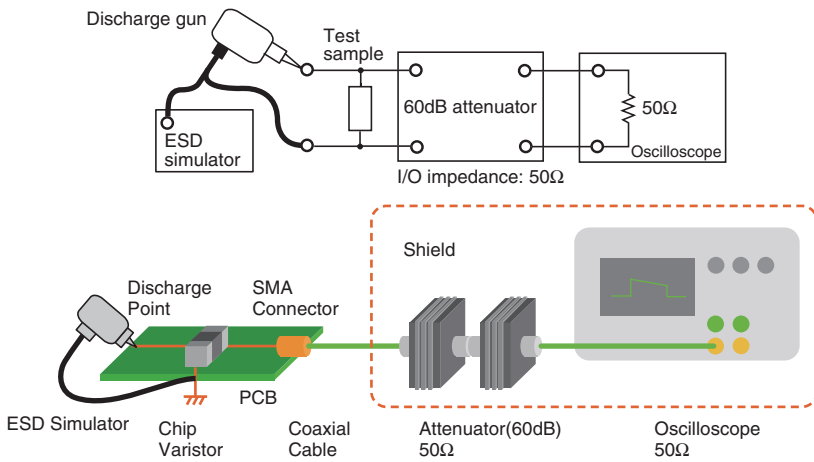

⚠ Please be sure to request delivery specifications that provide further details on the features and specifications of the products for proper and safe use. Please note that the contents may change without any prior notice due to reasons such as upgrading.

Chip varistors

Automotive grade

Product compatible with RoHS directive
Compatible with lead-free solders
AEC-Q200

AVR series Electrostatic discharge tests

APPLIED VOLTAGE STEP(VOLTAGE 10TIMES APPLIED) **REPEATED VOLTAGE APPLICATION(~ 1000 times)**

AVRH10C270KT150NA8 (Voltage % change at reference current: within ±10%)

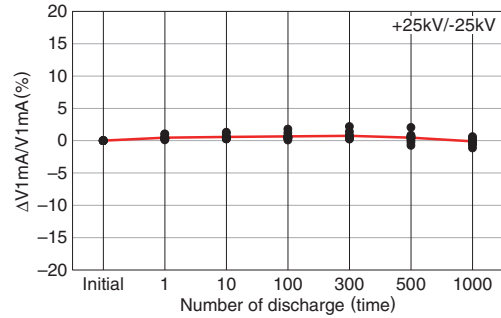
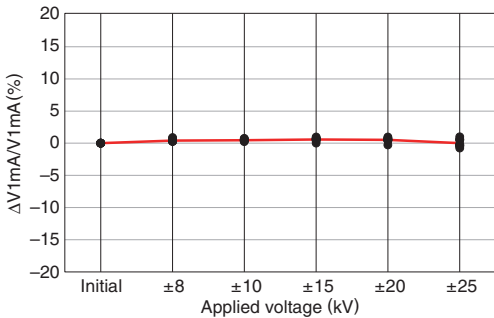

AVR-M1608C270MTAAB (Voltage % change at reference current: within ±10%)

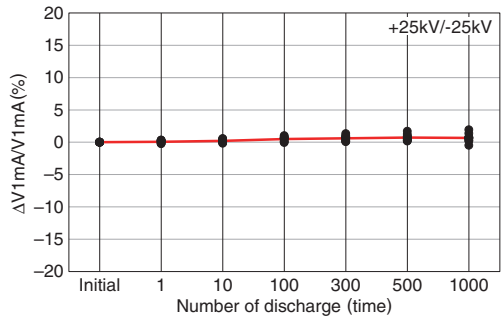
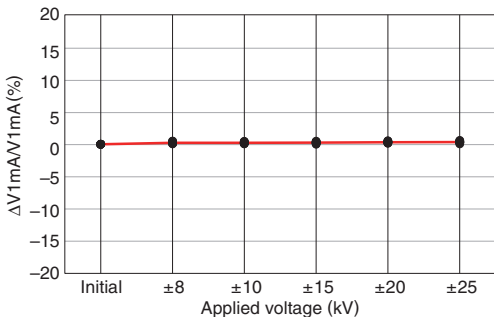

AVR-M2012C390KT6AB (Voltage % change at reference current: within ±10%)

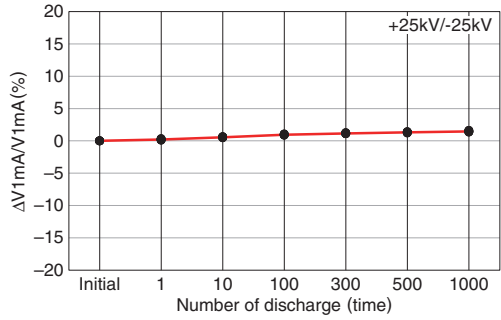
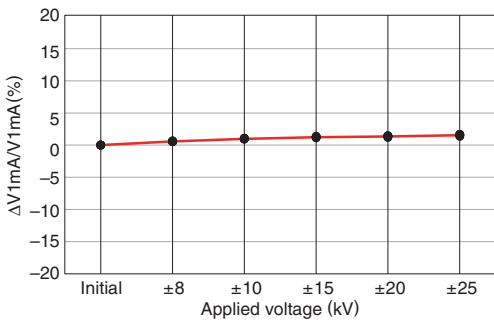

AVRL101D3R3FTA(Capacitance: 5pF or less)

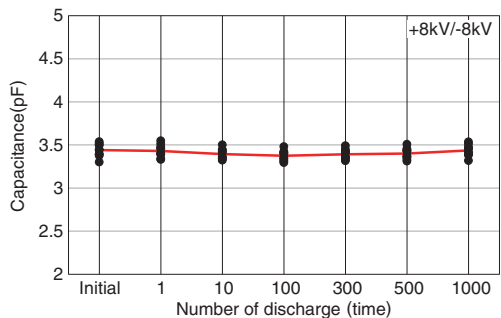
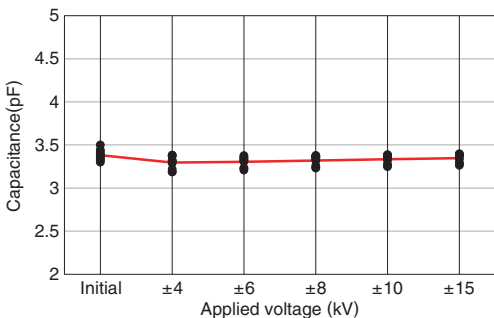

* ESD condition: 150pF/330Ω(IEC61000-4-2)

⚠ Please be sure to request delivery specifications that provide further details on the features and specifications of the products for proper and safe use. Please note that the contents may change without any prior notice due to reasons such as upgrading.

Chip varistors

Automotive grade

Product compatible with RoHS directive
Compatible with lead-free solders
AEC-Q200

Attention on a circuit board design

Board design

When attached to chip varistors, amount of silver used (fillet size) has direct impact on chip varistors after mounting. Thus, sufficient consideration is necessary.

Set of land dimensions

(1) As the stress rises in the chip varistors owing to the increase in silver, breakage and cracks will occur. Cause including crack, as caution on board land design, configure the shape and dimensions so that the amount of silver is appropriate. If you installed 2 or more parts in the Common Land, separated by a solder resist and special land of each component.

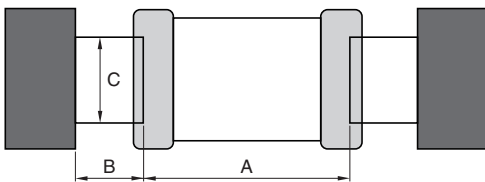

| Dimensions shape | Symbol | | |
|------------------|--------------|--------------|--------------|
| | A | B | C |
| 1005 | 0.30 to 0.50 | 0.35 to 0.45 | 0.40 to 0.60 |
| 1608 | 0.60 to 0.80 | 0.60 to 0.80 | 0.60 to 0.80 |
| 2012 | 0.90 to 1.20 | 0.70 to 0.90 | 0.90 to 1.20 |

(2) When peak levels panning-at soldering is excessive, by solder contraction stress, mechanical-thermal stress causes a Yasuko chip crack. In addition, when the peak level is underestimated, terminal electrode fixed strength is insufficient. This causes chip dropouts and may affect circuit reliability. Representative example of the panning of peak levels is shown in the following.

Recommended silver dose

| | | |
|------------------------|--|---|
| Solder volume overload | | Solder stress is increased, and it is easy for a crack to form. |
| Decent solder volume | | Most large serving amount Minimum prime amount |
| Solder volume deficit | | Fixed strength is weak, and there is connection a problem and risk of loss. |

Case and suggested protocol want to avoid

| Example | Cases to avoid | Improvement example (land division) |
|--|----------------|-------------------------------------|
| Lead wire and land of part discrete doubles up | | |
| Arrangements in the vicinity | | |
| Arrangements of chip component's companion | | |

⚠ Please be sure to request delivery specifications that provide further details on the features and specifications of the products for proper and safe use. Please note that the contents may change without any prior notice due to reasons such as upgrading.

Chip varistors Automotive grade

Product compatible with RoHS directive
Compatible with lead-free solders
AEC-Q200

Attention on a circuit board design

Arrangements of components

(1) I was based on camber of substrate and suggested protocol of chip varistors arrangement, as stress does not join to the utmost is shown in following.

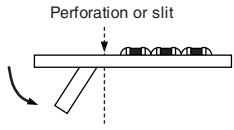
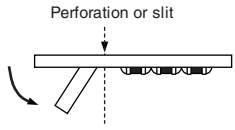
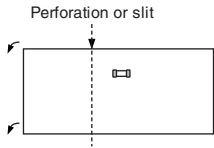
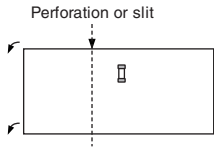
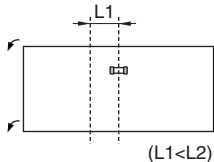
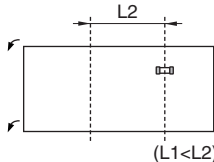
| | Substrate for flexural stress Adverse events | Substrate for flexural stress Good example |
|--|--|---|
| Direction of surface solder |  <p>Solder the mountain fold as a top.</p> |  <p>Solder the mountain fold as a bottom. [Please review the italicized portion, as I am unsure what you mean to convey here.]</p> |
| Chip arrangements (direction) |  <p>Mounted vertically to the perforation and slit.</p> |  <p>Mounted horizontally to the perforation and slit.</p> |
| Distance from perforation and slit portion |  <p>($L1 < L2$)</p> <p>Close location is disadvantageous of perforation and slit.</p> |  <p>($L1 < L2$)</p> <p>It is an advantage so distant location away places the perforation and slit.</p> |

(2) In payment near by board, depending on mount position of chip varistors, as mechanical stress varies, please refer to the following diagram.

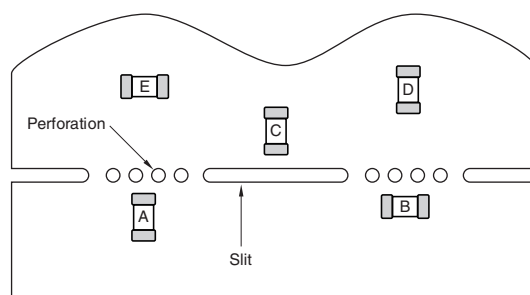

The order of $A > B = C > D > E$ eases the stress.

⚠ Please be sure to request delivery specifications that provide further details on the features and specifications of the products for proper and safe use. Please note that the contents may change without any prior notice due to reasons such as upgrading.

Product compatible with RoHS directive
Compatible with lead-free solders
AEC-Q200

Chip varistors

Automotive grade

Local precautions

Application to board

Mounting head pressure

Under suction nozzle if dead point too, during implementation, excessive force joins of chip varistors low, as cause of crack, please use with reference to something about following.

- 1) Being set to top surface of substrate so that under suction nozzle as for dead center, substrate does not bend back, and adjust, please.
- 2) Nozzle pressure at implementation is 0.1 to 0.3N in static load, please.
- 3) Substrate fixes up back surface of substrate with support pin in impact of suction nozzle to wely deflection to the utmost, and substrate hold deflection, please. A representative example is shown in the following.

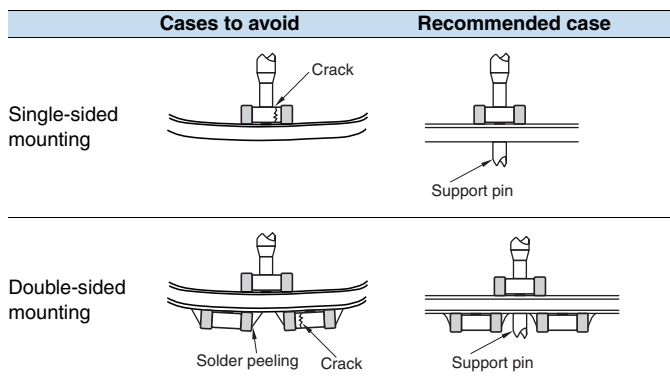

Mechanical shock that, if positioning your nail to wear, ragged edge of positionings, participates in chip varistors are locally, and chip varistors, as there is possibility of crack generated, cut the closed positioning, and maintenance and inspection, and, exchange of manage dimensions and position nail periodically, please.

Soldering

Significant impact is possible on the performance of chip varistors, flux checks something about follow, please use.

- (1) Flux uses one with 0.1wt % (Cl conversion) or less halide substance contains amounts, please. In addition, do not do this with strongly acidic objects.
- Flux during is soldered (2) Chip varistors is applied the smallest amount necessary, please.
- (3) If Used soluble flux, perform thorough wash particularly, please.

Reflow temperature profile

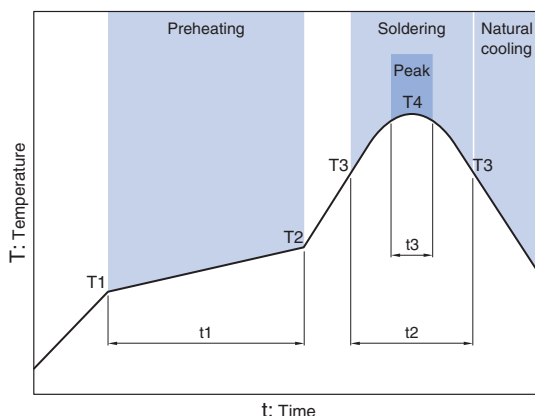

| Item | Specification | |
|--|-----------------------------|-------------------------|
| | For eutectic mixture solder | Use of lead-free solder |
| Preheating temperature | 160 to 180°C | 150 to 180°C |
| Solder melting temperature | 200°C | 230°C |
| Maximum temperature | 240°C max. | 260°C max. |
| Preheating time | 100s max. | 120s max. |
| Time to reach higher than the solder melting temperature | 30s max. | 40s max. |
| number of possible reflow cycles | 2 max. | 2 max. |

Soldering iron

The tip temperature and also by (1) types of soldering irons, the size of the substrate, and the geometry of the land pattern. Being earlier, but when as there is possibility that crack occurs in the heat anderson impaction, point soldering iron temperature is high, please do solder work within the following conditions.

| Temperature of iron tips (°C) | Wattage (W) | Palat point shape (mm) | Soldering time (Second) | Frequency |
|-------------------------------|-------------|------------------------|-------------------------|---|
| 350max. | 30max. | ø3.0max. | 5 max. | Within each terminal once (Within total of twice) |

Direct iron tip is in contact with the (2) chip varistors body, and the strain owing to thermal shock in particular grows even if a crack is generated. Therefore, please do not touch it directly to the terminal electrodes.

⚠ Please be sure to request delivery specifications that provide further details on the features and specifications of the products for proper and safe use. Please note that the contents may change without any prior notice due to reasons such as upgrading.

Chip varistors

Automotive grade

Product compatible with RoHS directive
Compatible with lead-free solders
AEC-Q200

Attention after implementation

Cleaning

- (1) If cleaning liquid is inappropriate, residues and other foreign body of fluxes builds up on chip varistors, and can degrade the performance of chip varistors (particularly the insulation resistance).
- (2) Wash conditions may compromise performance of chip varistors if they are improper (wash due, wash excess).

2-1) For wash due

- (a) By substance of a system in flux residue halide, metal including terminal electrodes may experience corrosion.
- (b) Substance of a system in flux residue halide builds up on chip varistors, and reduces the insulation resistance.
- (c) Soluble flux makes comparisons of colophony series flux, and there is event with trends of significant (1) and(2).

2-2) For excess wash

- (1) Owing to lavage, chip varistors deteriorates, and reduces performance of chip varistors.
- (2) In ultrasonography, when output is passed, substrate resonates size, and crack occurs in body and sprang of chip varistors in vibration of substrate. Since this may reduce the strength of the terminal electrode, please note the following conditions. [Please review the italicized portion, as I am unsure what you mean to convey here.]
 - Ultrasound output
 - Ultrasonic frequency
 - Ultrasound cleaning time

2-3) Concentration including halogen that when cleaning liquid to pollution, when you released is higher, and may cause similar of results into wash due.

Substrate handling after component mounting

- (1) When substrate is divided, a flexible so that show in following diagram to substrate, and is given by stress including twist, as there is possibility that crack occurs of chip varistors, please check that stress is within acceptable limits.

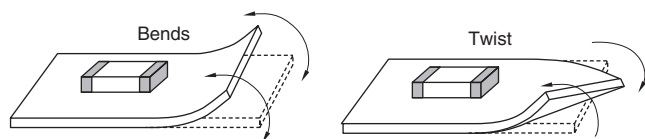

- (2) During each substrate operational check, push pressure with contact failure of check pin of boards checkers of check pin may be toned up to be prevented. As substrate is bent under loading, chip varistors is broken owing to stress. There is also the possibility that solder on the terminal electrode will peel off. Follow the diagram for reference, and check that the substrate bends, please.

| Item | Cases to avoid | Recommended case |
|----------------|----------------|------------------|
| Substrate sags | | |

Single-part component handling

To drop impact, as there is possibility that breakage and crack is entered, do not chip varistors that(1) chip varistors falls.

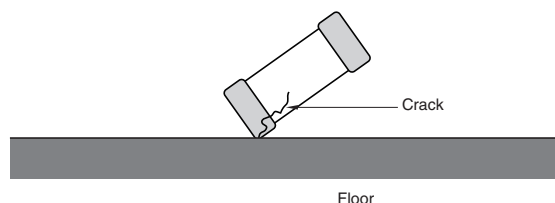

- (2) At stacking storage after implementation and treatment of substrate, corner of boards is regarded as chip varistors. Please be careful, as there is the possibility that breakage and cracks will occur on impact.

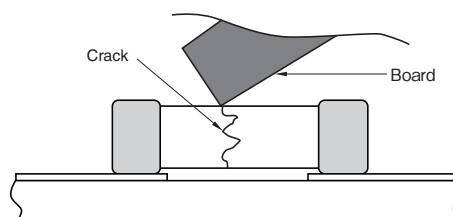

Chip varistors

Automotive grade

Product compatible with RoHS directive
Compatible with lead-free solders
AEC-Q200

Packaging style

REEL DIMENSIONS

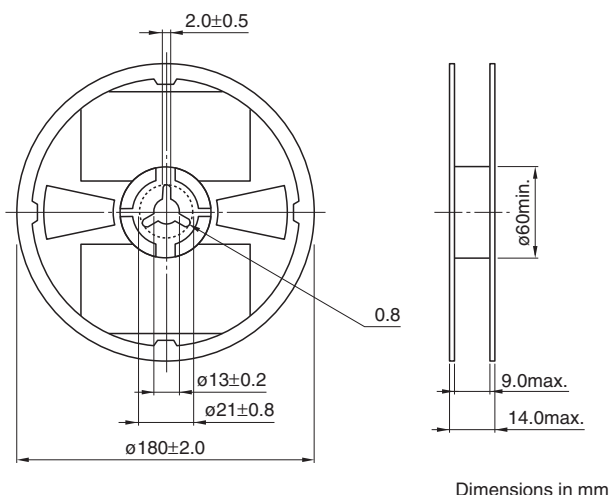

PACKAGE QUANTITY / INDIVIDUAL WEIGHT

| Type | Package quantity (pieces/reel) | Individual weight (mg) |
|------|--------------------------------|------------------------|
| 1005 | 10,000 | 1.3 |
| 1608 | 4,000 | 5.3 |
| 2012 | 2,000 | 13.0 |

TAPE DIMENSIONS

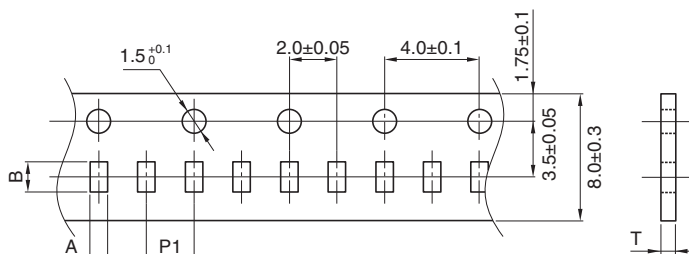

Dimensions in mm

| Type | A | B | P1 | T |
|------|----------------|----------------|--------|----------|
| 1005 | 0.65+0.05/-0.1 | 1.15+0.05/-0.1 | 2±0.05 | 0.65max. |
| 1608 | 1.1±0.2 | 1.9±0.2 | 4±0.1 | 1.1max. |
| 2012 | 1.6±0.2 | 2.3±0.2 | 4±0.1 | 1.7max. |

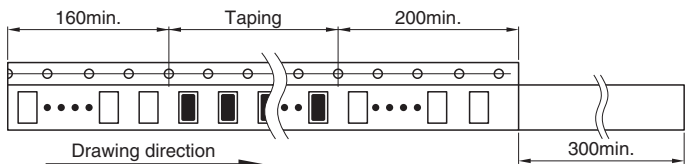

Dimensions in mm

⚠ Please be sure to request delivery specifications that provide further details on the features and specifications of the products for proper and safe use. Please note that the contents may change without any prior notice due to reasons such as upgrading.

REMINDERS FOR USING THESE PRODUCTS

Before using these products, be sure to request the delivery specifications.

SAFETY REMINDERS

Please pay sufficient attention to the warnings for safe designing when using this products.

REMINDERS

- Please pay careful attention to the precautions and follow safe designing practices when using these products.
- Please observe the following precautions in order to avoid problems with chip varistors such as characteristic degradation and element destruction
 - Please store these products in an environment with a temperature of 5 to 40°C and humidity level of 20 to 70%RH, and use them within six months.
 - Poor storage conditions may lead to the deterioration of the solderability of the edge electrodes, so please be careful to avoid contact with humidity, dew condensation, dust, toxic gas (hydrogen, hydrogen sulfide, sulfurous acid, chlorine, ammonia, etc.), direct sunlight, and so on.
 - Please do not use products that have been dropped or detached when mounting.
 - Please solder with the reflow soldering method, and not the flow (dip) soldering method.
- Please observe the following precautions to avoid problems with varistors such as characteristic degradation and element destruction, which ultimately lead to the generation of heat and smoke with the elements.
 - Do not use in locations where the temperatures exceed the operating temperature range such as under direct sunlight or near sources of heat.
 - Do not use in locations where there are high levels of humidity such as under direct exposure to weather and areas where steam is released.
 - Do not use in locations such as dusty areas, high-saline environments, places where the atmosphere is contaminated with corrosive gas, etc.
 - Avoid powerful vibrations, impact (such as by dropping), pressure, etc. that may lead to splitting in the products.
 - Do not use with a voltage that exceeds the maximum allowable circuit voltage.**
 - When resin coating (including modular) a varistor, do not use a resin that will cause deterioration of the varistor. Be sure never to use resin that generates hydrogen as palladium is used for the inner electrode.
 - Avoid attachment near combustible materials.
- Please contact our sales offices when considering the use of the products listed on this catalog for applications, whose performance and/or quality require a more stringent level of safety or reliability, or whose failure, malfunction or trouble could cause serious damage to society, person or property ('specific uses' such as automobiles, airplanes, medical instruments, nuclear devices, etc.) as well as when considering the use for applications that exceed the range and conditions of this catalog.
 - Please also contact us when using these products for automotive applications.
- As range of catalog, conditions are transcended, or for damage that generated by was used in application specific, etc, accept no the responsibility, wish.
- Please take appropriate measures such as acquiring protective circuits and devices that meet the uses, applications, and conditions of the instruments and keeping backup circuits.

Компания «Океан Электроники» предлагает заключение долгосрочных отношений при поставках импортных электронных компонентов на взаимовыгодных условиях!

Наши преимущества:

- Поставка оригинальных импортных электронных компонентов напрямую с производств Америки, Европы и Азии, а так же с крупнейших складов мира;
- Широкая линейка поставок активных и пассивных импортных электронных компонентов (более 30 млн. наименований);
- Поставка сложных, дефицитных, либо снятых с производства позиций;
- Оперативные сроки поставки под заказ (от 5 рабочих дней);
- Экспресс доставка в любую точку России;
- Помощь Конструкторского Отдела и консультации квалифицированных инженеров;
- Техническая поддержка проекта, помощь в подборе аналогов, поставка прототипов;
- Поставка электронных компонентов под контролем ВП;
- Система менеджмента качества сертифицирована по Международному стандарту ISO 9001;
- При необходимости вся продукция военного и аэрокосмического назначения проходит испытания и сертификацию в лаборатории (по согласованию с заказчиком);
- Поставка специализированных компонентов военного и аэрокосмического уровня качества (Xilinx, Altera, Analog Devices, Intersil, Interpoint, Microsemi, Actel, Aeroflex, Peregrine, VPT, Syfer, Eurofarad, Texas Instruments, MS Kennedy, Miteq, Cobham, E2V, MA-COM, Hittite, Mini-Circuits, General Dynamics и др.);

Компания «Океан Электроники» является официальным дистрибьютором и эксклюзивным представителем в России одного из крупнейших производителей разъемов военного и аэрокосмического назначения «JONHON», а так же официальным дистрибьютором и эксклюзивным представителем в России производителя высокотехнологичных и надежных решений для передачи СВЧ сигналов «FORSTAR».



JONHON

«JONHON» (основан в 1970 г.)

Разъемы специального, военного и аэрокосмического назначения:

(Применяются в военной, авиационной, аэрокосмической, морской, железнодорожной, горно- и нефтедобывающей отраслях промышленности)

«FORSTAR» (основан в 1998 г.)

ВЧ соединители, коаксиальные кабели, кабельные сборки и микроволновые компоненты:

(Применяются в телекоммуникациях гражданского и специального назначения, в средствах связи, РЛС, а так же военной, авиационной и аэрокосмической отраслях промышленности).



Телефон: 8 (812) 309-75-97 (многоканальный)

Факс: 8 (812) 320-03-32

Электронная почта: ocean@oceanchips.ru

Web: <http://oceanchips.ru/>

Адрес: 198099, г. Санкт-Петербург, ул. Калинина, д. 2, корп. 4, лит. А