

# M Series Half-inch Rotary Switches



## Features/Benefits

- Multi-pole and multi-positions
- Panel and PCB mounting
- Stainless steel actuator
- Non-shorting contacts
- RoHS Compliant

## Typical Applications

- Test equipment
- Industrial equipment
- Medical equipment



## Specifications

**CONTACT RATING:** Q contact material: Carry-6 AMPS continuous. Switch-250 mA max. @ 125 V AC or 28 DC. Non-shorting contacts standard. See page L-16 for additional ratings.

**ELECTRICAL LIFE:** 10,000 make-and-break cycles at 150 mA, 125 V AC or 28 DC.

**CONTACT RESISTANCE:** Below 20 mΩ typ. initial @ 2-4 V DC, 100 mA, for both silver and gold plated contacts.

**INSULATION RESISTANCE:** 10<sup>10</sup> Ω min.

**DIELECTRIC STRENGTH:** 600 Vrms min. @ sea level.

**OPERATING & STORAGE TEMPERATURE:** -30°C to 85°C.

**OPERATING TORQUE:** 4-7 ounces-inches typ. initial.

**SOLDERABILITY:** Per MIL-STD-202F method 208D, or EIA RS-186E method 9 (1 hour steam aging).

**NOTE:** Specifications and materials listed above are for switches with standard options. For information on specific and custom switches, consult Customer Service Center.

## Materials

**HOUSING AND BUSHING:** Zinc alloy, bright zinc plated, with clear chromate finish.

**ACTUATOR:** Zinc alloy, nickel plated or stainless steel.

**BASE:** Diallylphthalate (DAP) or melamine phenolic, with insert molded terminals.

**ROTOR:** Glass filled polyester (UL 94V-0).

**MOVABLE CONTACTS:**  
Non-shorting: Q contact material: Copper alloy, silver plated. See page L-16 for additional contact materials.

**STATIONARY CONTACT & ALL TERMINALS:** Q contact material: Copper alloy, silver plated. All terminals insert molded. All terminals present regardless of number of switch positions. See page L-16 for additional contact materials.

**CONTACT SPRING:** Music wire, phosphate coated.

**STOP PIN:** Stainless steel.

**STOP RING:** Brass.

**HARDWARE:** Nut: Brass, nickel plated; Lockwasher: Steel, nickel plated.

## Build-A-Switch

To order, simply select desired option from each category and place in the appropriate box. Available options are shown and described on pages L-14 thru L-18. For additional options not shown in catalog, consult Customer Service Center.

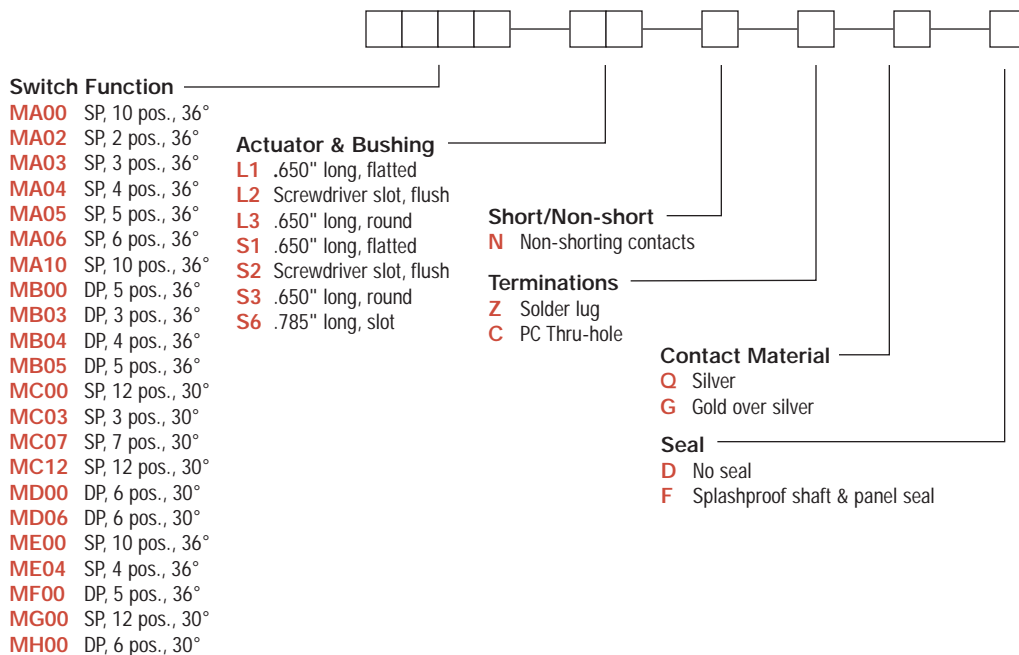

Dimensions are shown: Inch (mm)  
Specifications and dimensions subject to change

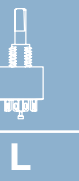

# M Series Half-inch Rotary Switches

## SWITCH FUNCTION

36° INDEXING			
NO. POLES	MODEL NO. WITH STOP PINS	MODEL NO. WITH STOP RINGS	SWITCH FUNCTION
SP	MA00	ME00	10 Positions No Stops
	MA02	—	2 Positions
	MA03	—	3 Positions
	MA04	ME04	4 Positions
	MA05	—	5 Positions
	MA06	—	6 Positions
	MA10	—	10 Positions
DP	MB00	MF00	5 Positions No Stops
	MB03	—	3 Positions
	MB04	—	4 Positions
	MB05	—	5 Positions

SP MODELS 36° INDEXING SCHEMATIC

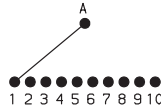

DP MODELS 36° INDEXING SCHEMATIC

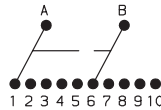

SP MODELS 30° INDEXING SCHEMATIC

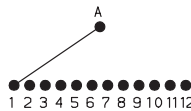

DP MODELS 30° INDEXING SCHEMATIC

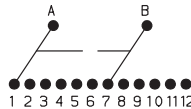

30° INDEXING			
NO. POLES	MODEL NO. WITH STOP PINS	MODEL NO. WITH STOP RINGS	SWITCH FUNCTION
SP	MC00	MG00	12 Positions No Stops
	MC03	—	3 Positions
	MC07	—	7 Positions
DP	MD00	MH00	6 Positions No Stops
	MD06	—	6 Positions

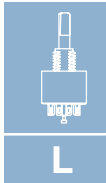

Rotary

All models with all options when ordered with S1-SB stainless steel actuator options.

**NOTE:** Number of positions or stops preset at factory (NOTE: MX00 models have full 360 rotation with no stops. Stop pins or stop rings supplied for user-selectable stops, see above). All terminals present regardless of number of switch positions. Hardware is available separately, see section "Technical Data and Additional Hardware".

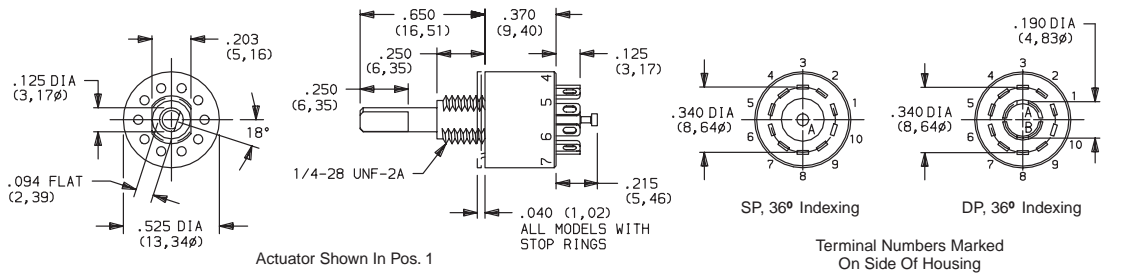

Actuator Shown In Pos. 1

SP, 36° Indexing

DP, 36° Indexing

Terminal Numbers Marked On Side Of Housing

Part number shown: MA00L1NZ0D

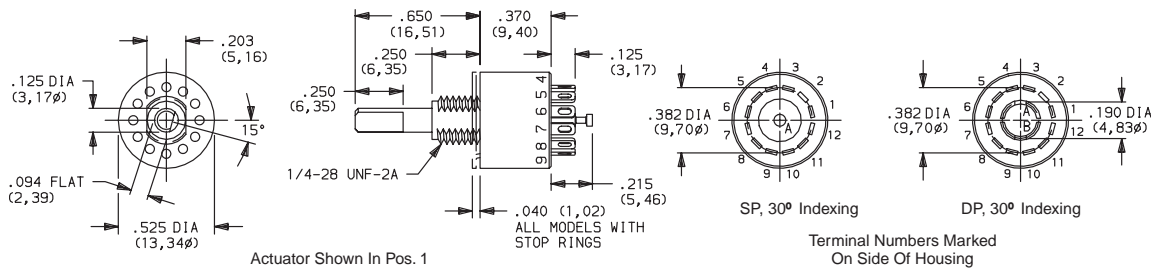

Actuator Shown In Pos. 1

SP, 30° Indexing

DP, 30° Indexing

Terminal Numbers Marked On Side Of Housing

Part number shown: MC00L1NZ0D

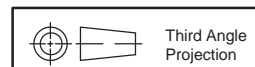

Dimensions are shown: Inch (mm)  
Specifications and dimensions subject to change



# M Series Half-inch Rotary Switches

## ACTUATOR (ZINC ALLOY)



**L1** .650" LONG, FLATTED

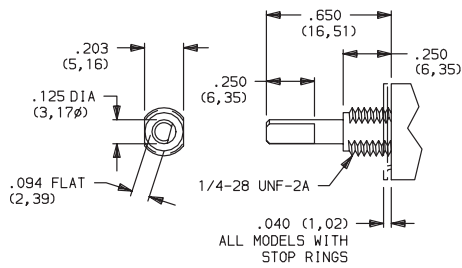

**L2** SCREWDRIVER SLOT, FLUSH

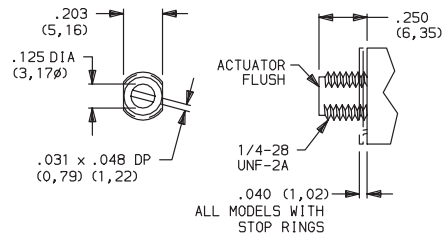

**L3** .650" LONG, ROUND

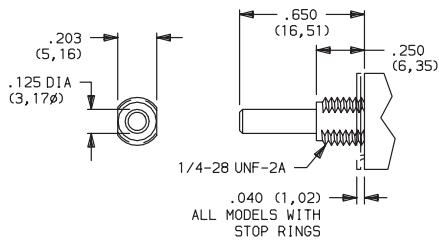

All actuators shown in pos. 1

## ACTUATOR (STAINLESS STEEL)



**S1** .650" LONG, FLATTED

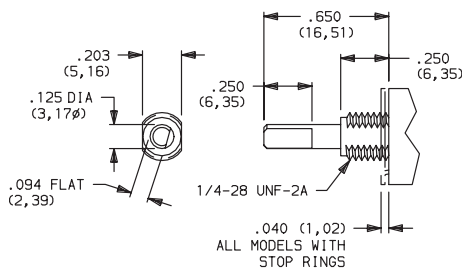

**S2** SCREWDRIVER SLOT, FLUSH

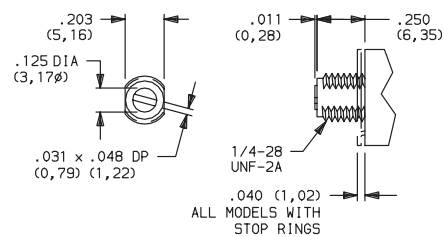

**S3** .650" LONG, ROUND

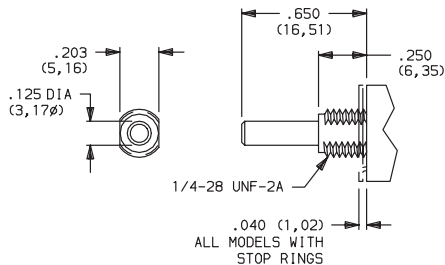

**S6** .785" LONG, SLOT

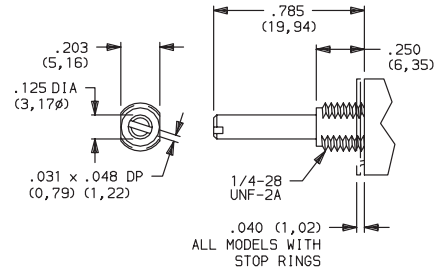

All actuators shown in pos. 1

All models UL/CSA when ordered with stainless steel actuators.



Third Angle  
Projection

Dimensions are shown: Inch (mm)  
Specifications and dimensions subject to change



# M Series Half-inch Rotary Switches

## SHORTING/NON-SHORTING CONTACTS



### N NON-SHORTING CONTACTS

Break-before-make

## TERMINATIONS



### Z SOLDER LUG

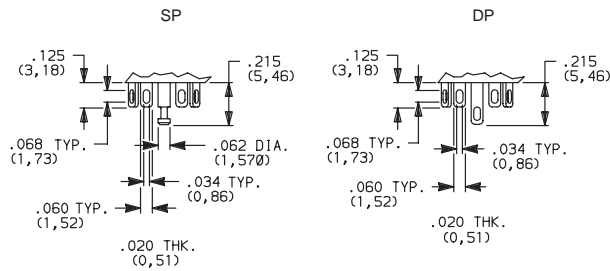

### C PC THRU-HOLE

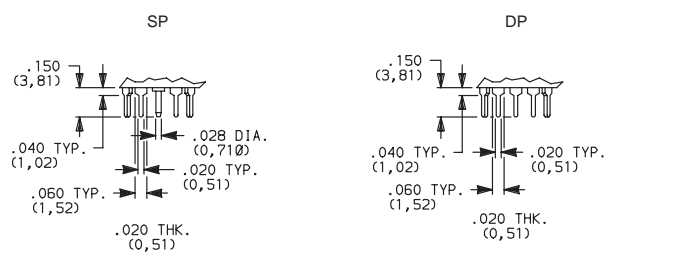

### PANEL MOUNTING

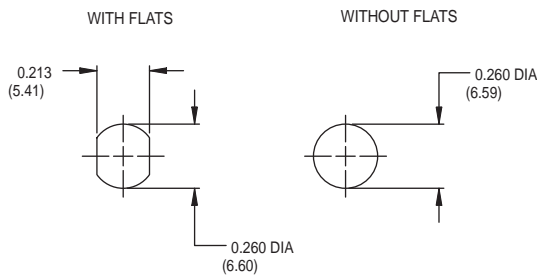

### PC MOUNTING 36° INDEXING

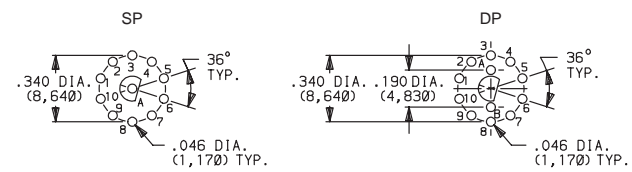

### PC MOUNTING 30° INDEXING

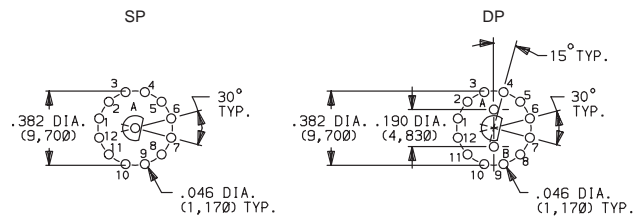

Hardware: All models, one mounting nut and lockwasher supplied standard. MA00 thru MD00 models: two stop pins and adhesive mylar washer supplied. ME00 thru MH00 models: two stop rings supplied. Hardware is available separately, see section "Technical Data and Additional Hardware".

Actuators and schematics shown in pos. 1.

NOTE: Q contact material standard. Terminal numbers marked on side of housing. All terminals insert molded. All terminals present regardless of number of switch positions.

## CONTACT MATERIAL



OPTION CODE	CONTACT MATERIAL	TERMINAL PLATING	RATING	
Q	SILVER <sup>1,2</sup>	SILVER <sup>2</sup>	POWER	CARRY: 6 AMPS CONTINUOUS. SWITCH: 250 mA @ 125 V AC or 28 V DC.
G	GOLD OVER SILVER <sup>3,4</sup>	GOLD <sup>4</sup>	LOW LEVEL/DRY CIRCUIT OR POWER	0.4 VA MAX. @ 20 V AC or DC MAX. or, CARRY: 6 AMPS CONTINUOUS. SWITCH: 250 mA @ 125 V AC or 28 V DC.

\* Note: See Technical Data section of this catalog for RoHS compliant and compatible definition and specifications.

<sup>1</sup> MOVABLE CONTACTS: Non-shorting: Copper alloy, silver plated. Shorting: Zinc alloy, silver plated.

<sup>2</sup> STATIONARY CONTACTS & ALL TERMINALS: Copper alloy, silver plated.

<sup>3</sup> MOVABLE CONTACTS: Non-shorting: Copper alloy, with gold plate over nickel plate, over silver plate. Shorting: Zinc alloy, with gold plate.

<sup>4</sup> STATIONARY CONTACTS & ALL TERMINALS: Copper alloy, with gold plate over nickel plate over silver plate.

NOTE: Any models supplied with Q, G contact material are RoHS compliant.

All models  when ordered with S1-S6 stainless steel actuator options.

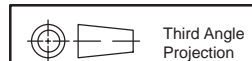

Third Angle Projection

Dimensions are shown: Inch (mm)  
Specifications and dimensions subject to change



# M Series Half-inch Rotary Switches

SEAL 

**D** NO EPOXY SEAL

**F** SPLASHPROOF SHAFT AND PANEL SEAL

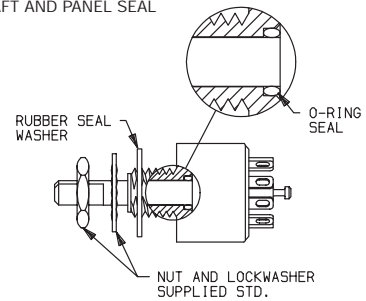

## Setting Stops With Stop Pins

**MA00, MB00, MC00 & MD00 Models Only:**

The number of switch positions or stops are adjustable by means of stop pins provided with each switch. Switches are normally shipped with stop pins and hardware in bulk, not installed. Without stop pins, switches have full 360° rotation and no stops. Note that all two pole models begin to repeat when actuated 180° or more.

To set stops, refer to figures 1 & 2. Orient switch so that terminal no. 1 is as shown. Turn actuator to position 1, using flats on bushing and terminal no. 1 as reference. Install CCW stop pin in hole designated 'X'. Install second stop pin in hole number corresponding to the number of positions desired. Note that two pole models will begin to repeat when actuated 180° or more. To retain stop pins, use adhesive mylar washer included; see figure 3.

All models except MX00 models have number of switch positions or stops pre-set at factory and are not adjustable.

**Hardware:**

Two stop pins, mounting nut, and lockwasher supplied standard.

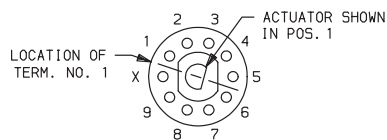

36° Indexing Models  
Top View

Fig. 1

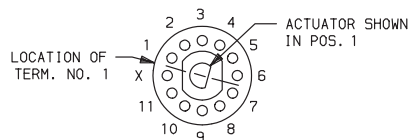

30° Indexing Models  
Top View

Fig. 2

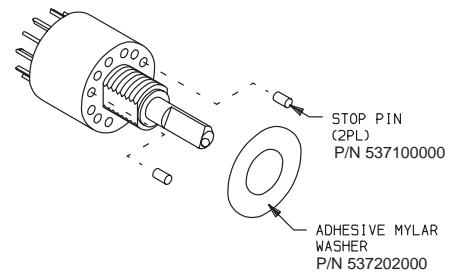

Fig. 3

## Setting Stops With Stop Rings

**ME00, MF00, MG00 & MH00 Models Only:**

The number of switch positions or stops are adjustable by means of stop rings provided with each switch. These models are normally shipped with stop rings and hardware in bulk, not installed. Without stop rings, switches have full 360° rotation and no stops. Note that all two pole models begin to repeat when actuated 180° or more.

To set stops refer to figures 4 & 5. Orient switch so that terminal no. 1 is as shown. Turn actuator to pos. 1 using flats on bushing and terminal no. 1 as reference. See figure 6 and install inner stop ring with short tab in hole designated 'X'. Install outer stop ring with long tab in hole number corresponding to the number of positions desired. Note that all two pole models begin to repeat when actuated 180° or more. Use mounting nut and lockwasher to retain stop rings.

**All MEXX, MFXX, MGXX & MHXX Models (Except MX00 models):**

Number of switch positions or stops are preset at factory, but are user adjustable.

**Hardware:**

Two stop rings, mounting nut and lockwasher supplied standard.

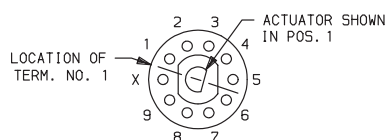

36° Indexing Models  
Top View

Fig. 4

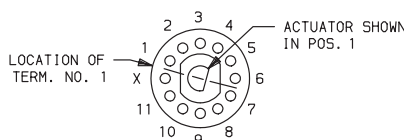

30° Indexing Models  
Top View

Fig. 5

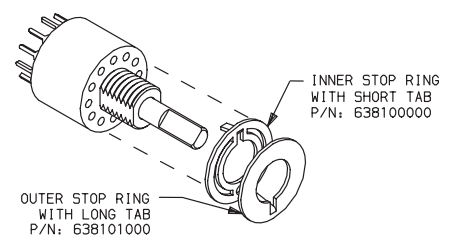

Fig. 6



Dimensions are shown: Inch (mm)  
Specifications and dimensions subject to change

Компания «Океан Электроники» предлагает заключение долгосрочных отношений при поставках импортных электронных компонентов на взаимовыгодных условиях!

Наши преимущества:

- Поставка оригинальных импортных электронных компонентов напрямую с производств Америки, Европы и Азии, а так же с крупнейших складов мира;
- Широкая линейка поставок активных и пассивных импортных электронных компонентов (более 30 млн. наименований);
- Поставка сложных, дефицитных, либо снятых с производства позиций;
- Оперативные сроки поставки под заказ (от 5 рабочих дней);
- Экспресс доставка в любую точку России;
- Помощь Конструкторского Отдела и консультации квалифицированных инженеров;
- Техническая поддержка проекта, помощь в подборе аналогов, поставка прототипов;
- Поставка электронных компонентов под контролем ВП;
- Система менеджмента качества сертифицирована по Международному стандарту ISO 9001;
- При необходимости вся продукция военного и аэрокосмического назначения проходит испытания и сертификацию в лаборатории (по согласованию с заказчиком);
- Поставка специализированных компонентов военного и аэрокосмического уровня качества (Xilinx, Altera, Analog Devices, Intersil, Interpoint, Microsemi, Actel, Aeroflex, Peregrine, VPT, Syfer, Eurofarad, Texas Instruments, MS Kennedy, Miteq, Cobham, E2V, MA-COM, Hittite, Mini-Circuits, General Dynamics и др.);

Компания «Океан Электроники» является официальным дистрибьютором и эксклюзивным представителем в России одного из крупнейших производителей разъемов военного и аэрокосмического назначения «JONHON», а так же официальным дистрибьютором и эксклюзивным представителем в России производителя высокотехнологичных и надежных решений для передачи СВЧ сигналов «FORSTAR».



## JONHON

«JONHON» (основан в 1970 г.)

Разъемы специального, военного и аэрокосмического назначения:

(Применяются в военной, авиационной, аэрокосмической, морской, железнодорожной, горно- и нефтедобывающей отраслях промышленности)

«FORSTAR» (основан в 1998 г.)

ВЧ соединители, коаксиальные кабели,  
кабельные сборки и микроволновые компоненты:

(Применяются в телекоммуникациях гражданского и специального назначения, в средствах связи, РЛС, а так же военной, авиационной и аэрокосмической отраслях промышленности).



Телефон: 8 (812) 309-75-97 (многоканальный)

Факс: 8 (812) 320-03-32

Электронная почта: [ocean@oceanchips.ru](mailto:ocean@oceanchips.ru)

Web: <http://oceanchips.ru/>

Адрес: 198099, г. Санкт-Петербург, ул. Калинина, д. 2, корп. 4, лит. А