

**FEATURES**

**Fixed gain of 20 dB**  
**Operation from 50 MHz to 4.0 GHz**  
**Highest dynamic range gain block**  
**Input/output internally matched to 50  $\Omega$**   
**Integrated bias control circuit**  
**OIP3 of 42.0 dBm at 2.0 GHz**  
**P1dB of 19.3 dBm at 2.0 GHz**  
**Noise figure of 3.3 dB at 2.0 GHz**  
**Single 5 V power supply**  
**Low quiescent current of 89 mA**  
**Thermally efficient SOT-89 package**  
**ESD rating of  $\pm 1.5$  kV (Class 1C)**

**GENERAL DESCRIPTION**

The [ADL5602](#) is a broadband 20 dB linear amplifier that operates at frequencies up to 4 GHz. The device can be used in a wide variety of cellular, CATV, military, and instrumentation equipment.

The [ADL5602](#) provides the highest dynamic range available from an internally matched gain block. This is accomplished by providing extremely low noise figures and very high OIP3 specifications simultaneously, across the entire 4 GHz frequency range.

The [ADL5602](#) provides a gain of 20 dB, which is stable over frequency, temperature, power supply, and from device to device. The device is internally matched to 50  $\Omega$  at the input and output, making the [ADL5602](#) very easy to implement in a wide variety of applications. Only input/output ac coupling capacitors, power supply decoupling capacitors, and an external inductor are required for operation.

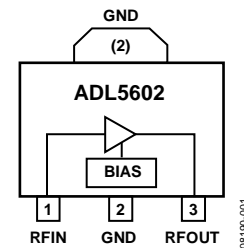
**FUNCTIONAL BLOCK DIAGRAM***Figure 1.*

The [ADL5602](#) is fabricated on an InGaP HBT process and has an ESD rating of  $\pm 1.5$  kV (Class 1C). The device is available in a thermally efficient SOT-89 package.

The [ADL5602](#) consumes 89 mA on a single 5 V supply and is fully specified for operation from  $-40^{\circ}\text{C}$  to  $+85^{\circ}\text{C}$ .

A fully populated RoHS-compliant evaluation board is available.

**TABLE OF CONTENTS**

Features .....	1	Basic Connections .....	12
Functional Block Diagram .....	1	Soldering Information and Recommended	
General Description .....	1	PCB Land Pattern.....	12
Revision History .....	2	W-CDMA ACPR Performance .....	13
Specifications.....	3	Evaluation Board .....	14
Typical Scattering Parameters (S Parameters).....	5	Outline Dimensions .....	15
Absolute Maximum Ratings.....	7	Ordering Guide .....	15
ESD Caution.....	7		
Pin Configuration and Function Descriptions.....	8		
Typical Performance Characteristics .....	9		

**REVISION HISTORY**

**11/13—Rev. 0 to Rev. A**

Changes to Figure 2.....	8
Added Figure 15, Renumbered Sequentially .....	11
Changes to Figure 17.....	12
Updated Outline Dimensions .....	15

**6/09—Revision 0: Initial Version**

## SPECIFICATIONS

$V_{CC} = 5\text{ V}$  and  $T_A = 25^\circ\text{C}$ , unless otherwise noted.

Table 1.

Parameter	Conditions	Min	Typ	Max	Unit
<b>OVERALL FUNCTION</b>					
Frequency Range		50		4000	MHz
<b>FREQUENCY = 50 MHz</b>					
Gain			18.3		dB
Output 1 dB Compression Point (P1dB)			18.0		dBm
Output Third-Order Intercept (OIP3)	$\Delta f = 1\text{ MHz}$ , output power ( $P_{OUT}$ ) = 0 dBm per tone		27.5		dBm
Second Harmonic	$P_{OUT} = 0\text{ dBm}$		-40.5		dBc
Third Harmonic	$P_{OUT} = 0\text{ dBm}$		-46.1		dBc
Noise Figure			2.9		dB
<b>FREQUENCY = 140 MHz</b>					
Gain			17.0		dB
vs. Frequency	$\pm 50\text{ MHz}$		$\pm 1.2$		dB
vs. Temperature	$-40^\circ\text{C} \leq T_A \leq +85^\circ\text{C}$		$\pm 0.03$		dB
vs. Supply Voltage	4.75 V to 5.25 V		$\pm 0.04$		dB
Output 1 dB Compression Point (P1dB)			18.3		dBm
Output Third-Order Intercept (OIP3)	$\Delta f = 1\text{ MHz}$ , output power ( $P_{OUT}$ ) = 0 dBm per tone		25.0		dBm
Second Harmonic	$P_{OUT} = 0\text{ dBm}$		-45.1		dBc
Third Harmonic	$P_{OUT} = 0\text{ dBm}$		-55.1		dBc
Noise Figure			2.9		dB
<b>FREQUENCY = 350 MHz</b>					
Gain			19.7		dB
vs. Frequency	$\pm 50\text{ MHz}$		$\pm 0.20$		dB
vs. Temperature	$-40^\circ\text{C} \leq T_A \leq +85^\circ\text{C}$		$\pm 0.31$		dB
vs. Supply Voltage	4.75 V to 5.25 V		$\pm 0.01$		dB
Output 1 dB Compression Point (P1dB)			20.0		dBm
Output Third-Order Intercept (OIP3)	$\Delta f = 1\text{ MHz}$ , output power ( $P_{OUT}$ ) = 0 dBm per tone		36.5		dBm
Second Harmonic	$P_{OUT} = 0\text{ dBm}$		-49.9		dBc
Third Harmonic	$P_{OUT} = 0\text{ dBm}$		-83.7		dBc
Noise Figure			3.0		dB
<b>FREQUENCY = 700 MHz</b>					
Gain		19.0	20.2	21.0	dB
vs. Frequency	$\pm 50\text{ MHz}$		$\pm 0.01$		dB
vs. Temperature	$-40^\circ\text{C} \leq T_A \leq +85^\circ\text{C}$		$\pm 0.28$		dB
vs. Supply Voltage	4.75 V to 5.25 V		$\pm 0.01$		dB
Output 1 dB Compression Point (P1dB)		19.0	20.1		dBm
Output Third-Order Intercept (OIP3)	$\Delta f = 1\text{ MHz}$ , output power ( $P_{OUT}$ ) = 0 dBm per tone		38.5		dBm
Second Harmonic	$P_{OUT} = 0\text{ dBm}$		-50.3		dBc
Third Harmonic	$P_{OUT} = 0\text{ dBm}$		-78.4		dBc
Noise Figure			3.0		dB

Parameter	Conditions	Min	Typ	Max	Unit
FREQUENCY = 900 MHz					
Gain		19.0	20.2	21.0	dB
vs. Frequency	±50 MHz		±0.01		dB
vs. Temperature	−40°C ≤ T <sub>A</sub> ≤ +85°C		±0.28		dB
vs. Supply Voltage	4.75 V to 5.25 V		±0.01		dB
Output 1 dB Compression Point (P1dB)		19.0	20.1		dBm
Output Third-Order Intercept (OIP3)	Δf = 1 MHz, output power (P <sub>OUT</sub> ) = 0 dBm per tone		40.0		dBm
Second Harmonic	P <sub>OUT</sub> = 0 dBm		−59.4		dBc
Third Harmonic	P <sub>OUT</sub> = 0 dBm		−77.3		dBc
Noise Figure			2.9		dB
FREQUENCY = 2000 MHz					
Gain			19.5		dB
vs. Frequency	±50 MHz		±0.04		dB
vs. Temperature	−40°C ≤ T <sub>A</sub> ≤ +85°C		±0.35		dB
vs. Supply Voltage	4.75 V to 5.25 V		±0.04		dB
Output 1 dB Compression Point (P1dB)			19.3		dBm
Output Third-Order Intercept (OIP3)	Δf = 1 MHz, output power (P <sub>OUT</sub> ) = 0 dBm per tone		42.0		dBm
Second Harmonic	P <sub>OUT</sub> = 0 dBm		−53.1		dBc
Third Harmonic	P <sub>OUT</sub> = 0 dBm		−60.7		dBc
Noise Figure			3.3		dB
FREQUENCY = 2600 MHz					
Gain			19.2		dB
vs. Frequency	±50 MHz		±0.01		dB
vs. Temperature	−40°C ≤ T <sub>A</sub> ≤ +85°C		±0.28		dB
vs. Supply Voltage	4.75 V to 5.25 V		±0.05		dB
Output 1 dB Compression Point (P1dB)			18.7		dBm
Output Third-Order Intercept (OIP3)	Δf = 1 MHz, output power (P <sub>OUT</sub> ) = 0 dBm per tone		36.5		dBm
Second Harmonic	P <sub>OUT</sub> = 0 dBm		−52.8		dBc
Third Harmonic	P <sub>OUT</sub> = 0 dBm		−67.4		dBc
Noise Figure			3.4		dB
FREQUENCY = 3500 MHz					
Gain			19.3		dB
vs. Frequency	±50 MHz		±0.03		dB
vs. Temperature	−40°C ≤ T <sub>A</sub> ≤ +85°C		±0.37		dB
vs. Supply Voltage	4.75 V to 5.25 V		±0.07		dB
Output 1 dB Compression Point (P1dB)			17.4		dBm
Output Third-Order Intercept (OIP3)	Δf = 1 MHz, output power (P <sub>OUT</sub> ) = 0 dBm per tone		31.5		dBm
Second Harmonic	P <sub>OUT</sub> = 0 dBm		−42.9		dBc
Third Harmonic	P <sub>OUT</sub> = 0 dBm		−66.4		dBc
Noise Figure			3.8		dB
FREQUENCY = 4000 MHz					
Gain			18.5		dB
vs. Frequency	±50 MHz		±0.19		dB
vs. Temperature	−40°C ≤ T <sub>A</sub> ≤ +85°C		±0.73		dB
vs. Supply Voltage	4.75 V to 5.25 V		±0.08		dB
Output 1 dB Compression Point (P1dB)			15.2		dBm
Output Third-Order Intercept (OIP3)	Δf = 1 MHz, output power (P <sub>OUT</sub> ) = 0 dBm per tone		28.0		dBm
Second Harmonic	P <sub>OUT</sub> = 0 dBm		−44.1		dBc
Third Harmonic	P <sub>OUT</sub> = 0 dBm		−64.0		dBc
Noise Figure			4.2		dB

Parameter	Conditions	Min	Typ	Max	Unit
POWER INTERFACE	VCC	4.5	5	5.5	V
Supply Voltage (V <sub>CC</sub> )			89	106	mA
Supply Current vs. Temperature	-40°C ≤ T <sub>A</sub> ≤ +85°C		±3		mA
Power Dissipation	V <sub>CC</sub> = 5 V		0.45		W

### TYPICAL SCATTERING PARAMETERS (S PARAMETERS)

V<sub>CC</sub> = 5 V and T<sub>A</sub> = 25°C, the effects of the test fixture have been de-embedded up to the pins of the device.

Table 2.

Frequency (MHz)	S11		S21		S12		S22	
	Magnitude (dB)	Angle (°)	Magnitude (dB)	Angle (°)	Magnitude (dB)	Angle (°)	Magnitude (dB)	Angle (°)
50	-12.75	+32.81	18.14	+163.00	-25.27	-9.54	-8.96	-145.86
100	-8.98	-7.00	15.77	-179.92	-27.59	+4.56	-7.07	-178.96
150	-10.11	-34.04	17.27	-169.01	-26.11	+16.05	-7.89	+159.89
200	-11.97	-50.46	18.50	-168.73	-24.84	+16.55	-9.33	+147.22
250	-13.85	-62.42	19.21	-171.01	-24.14	+14.79	-10.87	+140.02
300	-15.69	-72.90	19.64	-173.77	-23.70	+12.89	-12.23	+136.16
350	-17.40	-81.30	19.90	-176.45	-23.43	+11.02	-13.56	+134.03
400	-19.17	-88.48	20.07	-178.86	-23.26	+9.65	-14.79	+132.79
450	-20.86	-97.45	20.18	+178.79	-23.14	+8.07	-15.99	+132.72
500	-22.52	-107.32	20.25	+176.86	-23.08	+7.11	-17.02	+133.33
550	-24.32	-112.89	20.32	+174.84	-23.00	+6.15	-18.21	+133.04
600	-26.07	-120.03	20.35	+173.09	-22.97	+5.24	-19.45	+135.06
650	-27.89	-128.79	20.39	+171.35	-22.93	+4.35	-20.73	+136.29
700	-30.79	-133.19	20.42	+169.67	-22.91	+3.72	-22.22	+136.96
750	-34.53	-136.03	20.42	+167.93	-22.91	+2.93	-23.91	+135.39
800	-42.59	-130.76	20.46	+166.48	-22.88	+2.30	-26.35	+136.07
850	-46.49	-2.93	20.47	+164.85	-22.88	+1.67	-29.40	+132.08
900	-34.26	+15.99	20.47	+163.17	-22.86	+0.98	-34.27	+116.48
950	-29.55	+9.83	20.48	+161.77	-22.86	+0.39	-40.86	+41.72
1000	-25.87	+5.52	20.48	+160.25	-22.86	-0.21	-31.44	-10.36
1050	-23.03	+1.85	20.47	+158.65	-22.89	-0.84	-26.19	-18.99
1100	-21.25	+0.10	20.45	+157.18	-22.90	-1.43	-23.27	-22.34
1150	-19.31	-1.89	20.45	+155.50	-22.92	-2.06	-20.70	-22.26
1200	-17.72	-4.09	20.40	+153.93	-22.96	-2.72	-18.67	-24.44
1250	-16.13	-6.53	20.35	+152.44	-23.04	-3.38	-16.92	-24.75
1300	-14.81	-8.71	20.31	+150.88	-23.07	-4.04	-15.44	-25.79
1350	-13.65	-10.01	20.24	+149.35	-23.16	-4.60	-14.14	-25.36
1400	-12.68	-11.33	20.18	+147.91	-23.22	-5.06	-13.12	-25.73
1450	-11.72	-12.65	20.11	+146.40	-23.32	-5.76	-12.04	-25.59
1500	-10.92	-13.56	20.04	+145.13	-23.39	-6.16	-11.20	-25.40
1550	-10.21	-14.37	19.97	+143.86	-23.49	-6.54	-10.49	-25.60
1600	-9.58	-15.37	19.88	+142.58	-23.57	-6.93	-9.77	-25.59
1650	-9.05	-15.74	19.80	+141.40	-23.69	-7.16	-9.21	-25.31
1700	-8.52	-16.73	19.72	+140.23	-23.76	-7.45	-8.66	-25.42
1750	-8.13	-17.13	19.64	+139.13	-23.87	-7.60	-8.26	-25.32
1800	-7.76	-17.59	19.57	+138.12	-23.94	-7.80	-7.91	-24.96
1850	-7.46	-17.76	19.50	+137.16	-24.05	-7.88	-7.56	-24.77
1900	-7.19	-17.92	19.43	+136.25	-24.13	-7.91	-7.35	-24.46
1950	-6.98	-17.84	19.39	+135.31	-24.18	-7.94	-7.13	-23.92

Frequency (MHz)	S11		S21		S12		S22	
	Magnitude (dB)	Angle (°)	Magnitude (dB)	Angle (°)	Magnitude (dB)	Angle (°)	Magnitude (dB)	Angle (°)
2000	-6.85	-18.00	19.35	+134.44	-24.26	-7.99	-6.96	-23.55
2050	-6.74	-17.93	19.31	+133.61	-24.29	-7.91	-6.86	-22.70
2100	-6.63	-17.57	19.29	+132.74	-24.37	-7.81	-6.75	-22.45
2150	-6.66	-17.34	19.25	+132.06	-24.42	-7.58	-6.76	-22.01
2200	-6.65	-17.26	19.29	+131.19	-24.40	-7.63	-6.78	-21.42
2250	-6.69	-17.10	19.30	+130.47	-24.41	-7.59	-6.82	-20.82
2300	-6.77	-16.90	19.33	+129.54	-24.42	-7.40	-6.87	-20.25
2350	-6.87	-16.65	19.36	+128.72	-24.40	-7.46	-7.04	-19.57
2400	-7.05	-16.25	19.42	+127.81	-24.38	-7.50	-7.20	-18.85
2450	-7.22	-16.11	19.49	+126.89	-24.35	-7.46	-7.42	-18.17
2500	-7.45	-16.00	19.53	+125.82	-24.31	-7.75	-7.66	-17.76
2550	-7.64	-15.84	19.58	+124.74	-24.31	-7.86	-7.91	-17.18
2600	-7.95	-15.66	19.66	+123.61	-24.25	-8.20	-8.29	-16.64
2650	-8.29	-15.64	19.74	+122.46	-24.19	-8.54	-8.66	-16.15
2700	-8.62	-15.95	19.81	+121.20	-24.17	-8.90	-8.97	-15.97
2750	-8.95	-15.92	19.89	+119.91	-24.13	-9.35	-9.41	-15.67
2800	-9.31	-16.23	19.94	+118.47	-24.08	-9.95	-9.87	-15.96
2850	-9.67	-16.74	20.03	+117.02	-24.05	-10.55	-10.34	-16.17
2900	-9.99	-17.33	20.07	+115.47	-24.07	-11.17	-10.83	-16.68
2950	-10.28	-18.00	20.14	+113.95	-24.02	-11.71	-11.28	-17.66
3000	-10.53	-19.16	20.18	+112.28	-24.03	-12.51	-11.69	-19.15
3050	-10.69	-20.29	20.21	+110.53	-24.10	-13.72	-12.17	-21.42
3100	-10.86	-21.94	20.25	+108.77	-24.04	-14.66	-12.54	-24.24
3150	-10.91	-23.61	20.27	+107.15	-24.09	-15.23	-12.83	-27.07
3200	-10.70	-25.42	20.28	+105.16	-24.18	-16.23	-12.92	-32.00
3250	-10.57	-27.33	20.28	+103.09	-24.17	-17.39	-13.04	-36.71
3300	-10.38	-29.60	20.26	+101.20	-24.22	-18.24	-12.99	-42.66
3350	-9.92	-31.76	20.21	+99.05	-24.39	-20.06	-12.57	-48.16
3400	-9.48	-34.25	20.15	+96.98	-24.49	-20.74	-12.19	-54.36
3450	-8.98	-36.47	20.08	+94.93	-24.61	-21.69	-11.64	-59.44
3500	-8.44	-38.18	20.00	+92.80	-24.72	-23.44	-11.00	-64.07
3550	-7.92	-40.32	19.90	+90.88	-24.88	-24.35	-10.34	-68.43
3600	-7.34	-42.20	19.74	+88.69	-25.15	-25.31	-9.59	-72.77
3650	-6.79	-43.72	19.57	+86.66	-25.35	-26.95	-8.90	-76.09
3700	-6.29	-45.15	19.41	+84.80	-25.56	-27.76	-8.29	-79.17
3750	-5.82	-46.51	19.23	+82.83	-25.90	-28.90	-7.69	-81.76
3800	-5.37	-47.51	19.00	+81.05	-26.16	-29.05	-7.12	-84.30
3850	-4.93	-48.36	18.78	+79.53	-26.46	-30.35	-6.65	-86.42
3900	-4.56	-48.94	18.55	+78.02	-26.81	-29.93	-6.20	-88.14
3950	-4.23	-49.33	18.32	+76.71	-27.08	-31.04	-5.83	-89.69
4000	-3.97	-49.71	18.08	+75.39	-27.50	-30.65	-5.50	-91.14

## ABSOLUTE MAXIMUM RATINGS

Table 3.

Parameter	Rating
Supply Voltage, $V_{CC}$	6.5 V
Input Power (re: 50 $\Omega$ )	16 dBm
Internal Power Dissipation (Paddle Soldered)	600 mW
$\theta_{JA}$ (Junction to Air)	30.7°C/W
$\theta_{JC}$ (Junction to Paddle)	5.0°C/W
Maximum Junction Temperature	150°C
Lead Temperature (Soldering, 60 sec)	240°C
Operating Temperature Range	-40°C to +85°C
Storage Temperature Range	-65°C to +150°C

Stresses above those listed under Absolute Maximum Ratings may cause permanent damage to the device. This is a stress rating only; functional operation of the device at these or any other conditions above those indicated in the operational section of this specification is not implied. Exposure to absolute maximum rating conditions for extended periods may affect device reliability.

### ESD CAUTION



**ESD (electrostatic discharge) sensitive device.** Charged devices and circuit boards can discharge without detection. Although this product features patented or proprietary protection circuitry, damage may occur on devices subjected to high energy ESD. Therefore, proper ESD precautions should be taken to avoid performance degradation or loss of functionality.

**PIN CONFIGURATION AND FUNCTION DESCRIPTIONS**

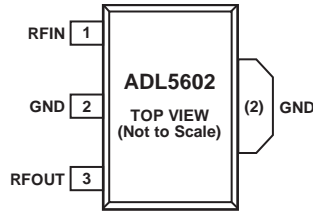

NOTES  
 1. EXPOSED PADDLE. INTERNALLY CONNECTED TO GND. SOLDER TO A LOW IMPEDANCE GROUND PLANE.

08150-002

Figure 2. Pin Configuration

Table 4. Pin Function Descriptions

Pin No.	Mnemonic	Description
1	RFIN	RF Input. This pin requires a dc blocking capacitor.
2	GND	Ground. Connect this pin to a low impedance ground plane.
3	RFOUT	RF Output and Supply Voltage. DC bias is provided to this pin through an inductor that is connected to the external power supply. The RF path requires a dc blocking capacitor.
(2)	Exposed Paddle	Exposed Paddle. Internally connected to GND. Solder to a low impedance ground plane.



# TYPICAL PERFORMANCE CHARACTERISTICS

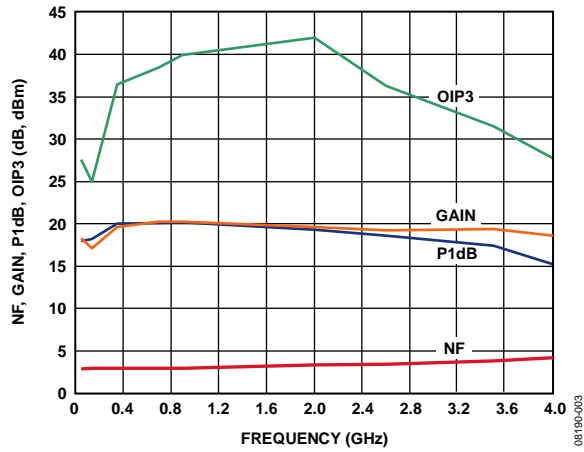

Figure 3. Noise Figure, Gain, P1dB, and OIP3 vs. Frequency

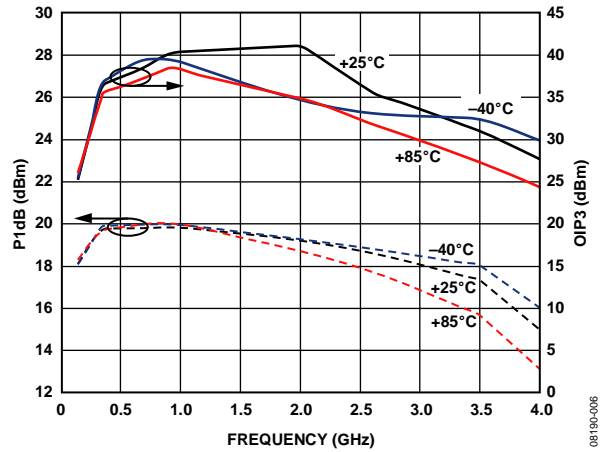

Figure 6. P1dB and OIP3 vs. Frequency and Temperature

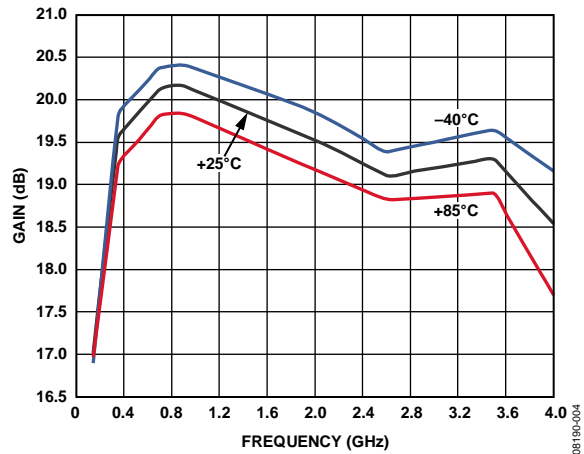

Figure 4. Gain vs. Frequency and Temperature

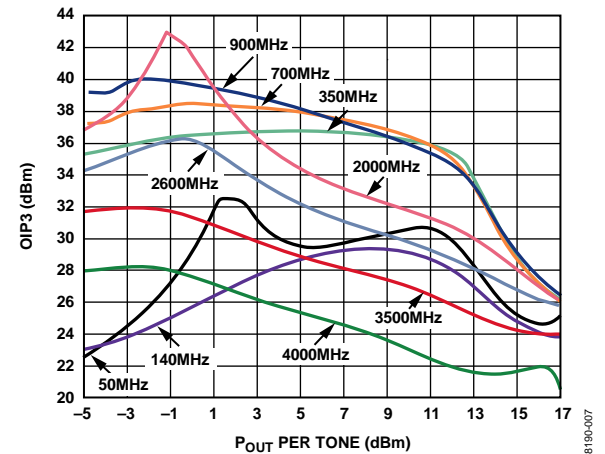

Figure 7. OIP3 vs. Output Power ( $P_{OUT}$ ) and Frequency

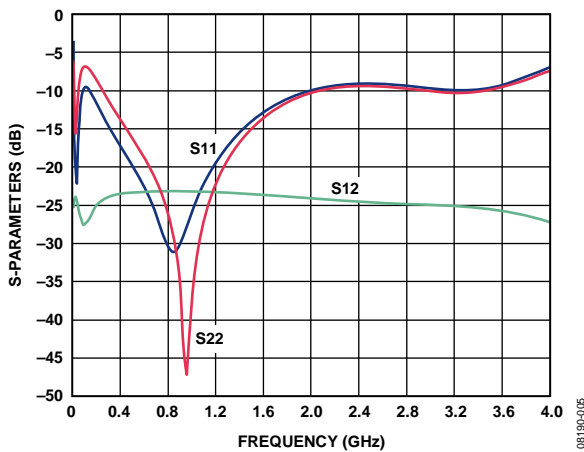

Figure 5. Input Return Loss ( $S_{11}$ ), Output Return Loss ( $S_{22}$ ), and Reverse Isolation ( $S_{12}$ ) vs. Frequency

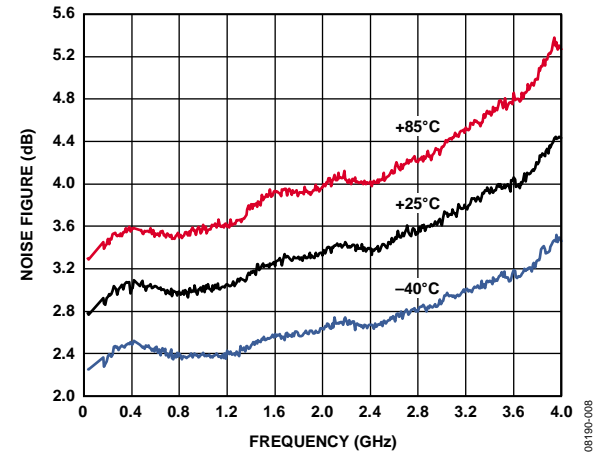

Figure 8. Noise Figure vs. Frequency and Temperature

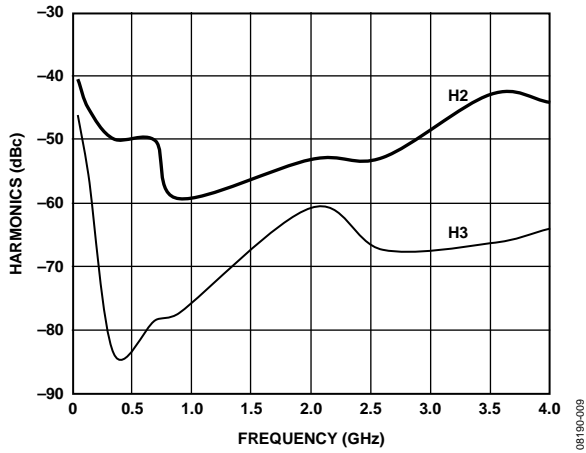

Figure 9. Single Tone Harmonics vs. Frequency,  $P_{OUT} = 0$  dBm

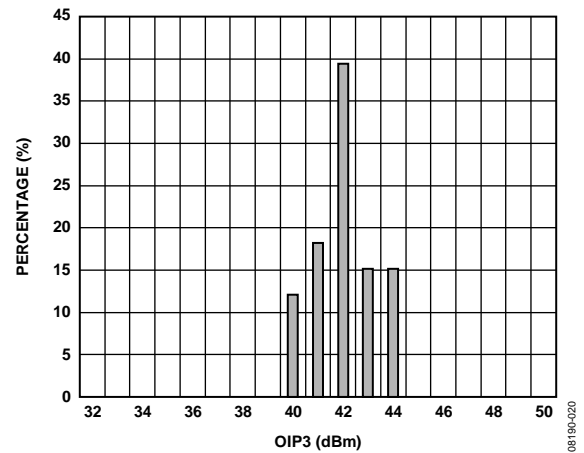

Figure 12. OIP3 Distribution at 2000 MHz,  $P_{OUT} = 0$  dBm

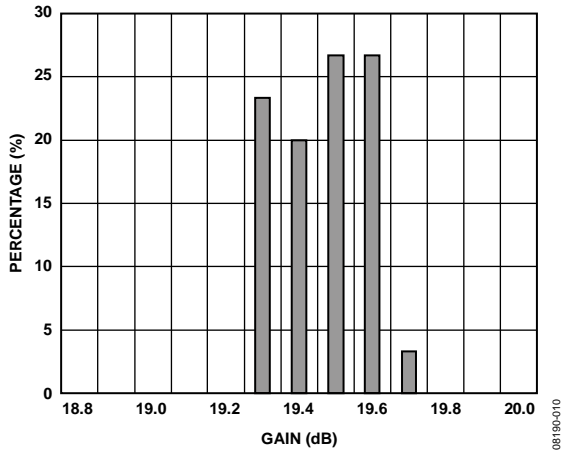

Figure 10. Gain Distribution at 2000 MHz

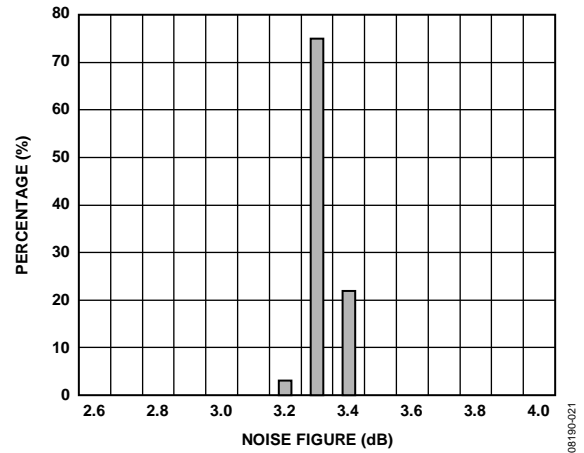

Figure 13. Noise Figure Distribution at 2000 MHz

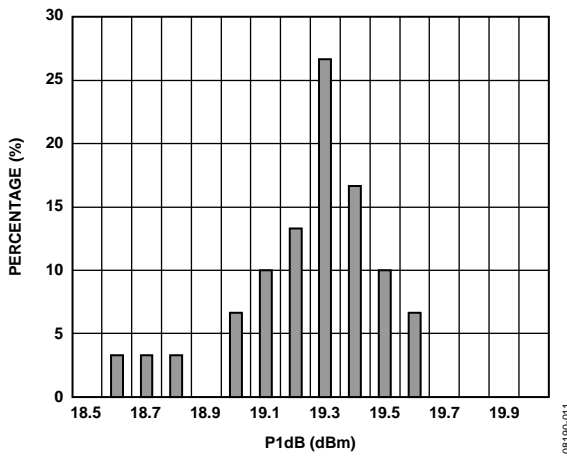

Figure 11. P1dB Distribution at 2000 MHz

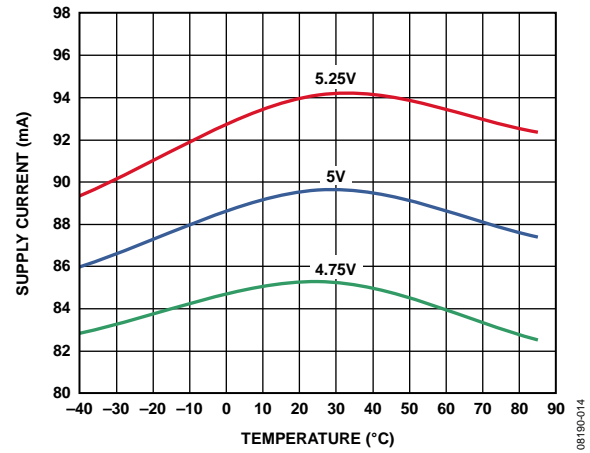

Figure 14. Supply Current vs. Temperature

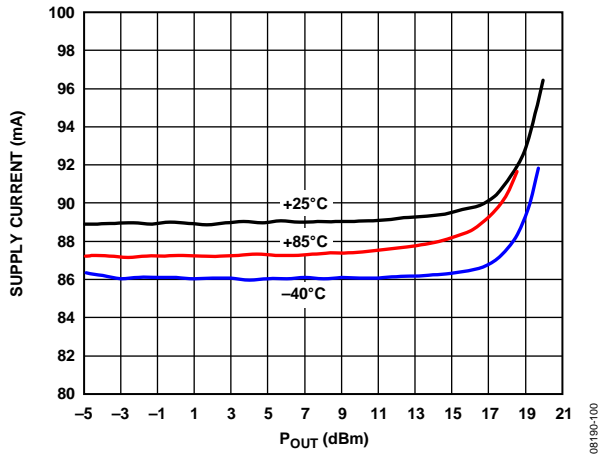

Figure 15. Supply Current vs. P<sub>OUT</sub> and Temperature V<sub>CC</sub> = 5 V

08190-100

## BASIC CONNECTIONS

The basic connections for operating the ADL5602 are shown in Figure 16. Recommended components are listed in Table 5. The input and output should be ac-coupled with appropriately sized capacitors (device characterization was performed with 0.1  $\mu$ F capacitors). A 5 V dc bias is supplied to the amplifier through the bias inductor connected to RFOUT (Pin 3). The bias voltage should be decoupled using a 1  $\mu$ F capacitor, a 1.2 nF capacitor, and a 68 pF capacitor.

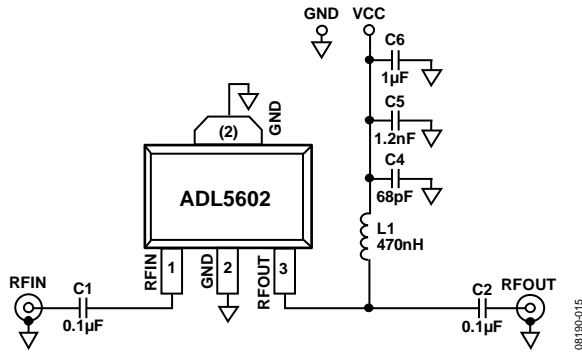

Figure 16. Basic Connections

## SOLDERING INFORMATION AND RECOMMENDED PCB LAND PATTERN

Figure 17 shows the recommended land pattern for the ADL5602. To minimize thermal impedance, the exposed paddle on the package underside should be soldered down to a ground plane along with Pin 2. If multiple ground layers exist, they should be stitched together using vias. For more information on land pattern design and layout, refer to the AN-772 Application Note, A Design and Manufacturing Guide for the Lead Frame Chip Scale Package (LFCSP).

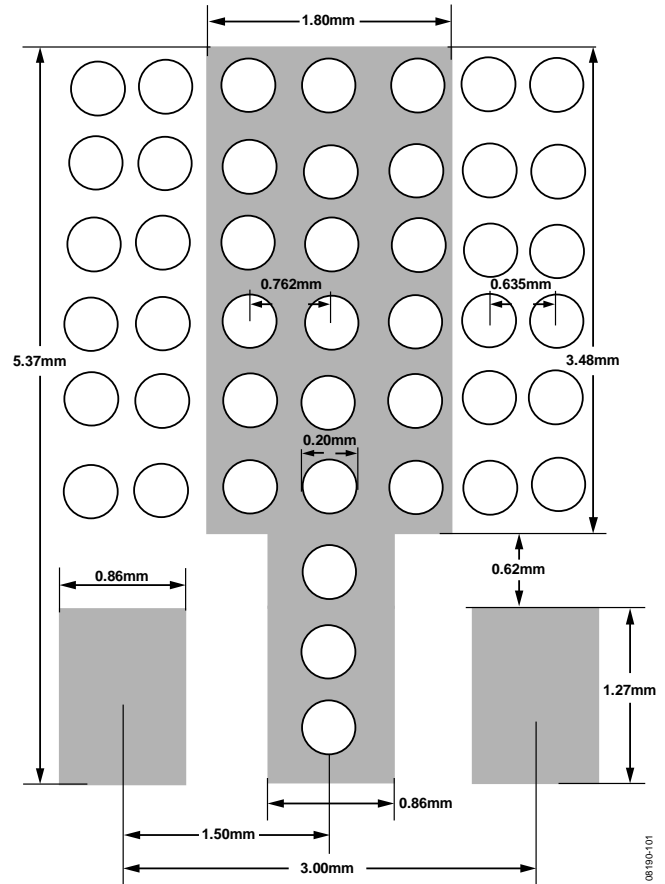

Figure 17. Recommended Land Pattern

Table 5. Recommended Components for Basic Connections

Frequency (MHz)	C1	C2	L1	C4	C5	C6
50 to 4000	0.1 $\mu$ F	0.1 $\mu$ F	470 nH (Coilcraft 0603LS-NX or equivalent)	68 pF	1.2 nF	1 $\mu$ F

## W-CDMA ACPR PERFORMANCE

Figure 18 shows a plot of adjacent channel power ratio (ACPR) vs.  $P_{OUT}$  for the ADL5602. The signal type being used is a single W-CDMA carrier (Test Model 1-64) at 2140 MHz. This signal is generated by a very low ACPR source. ACPR is measured at the output by a high dynamic range spectrum analyzer, which incorporates an instrument noise correction function.

The ADL5602 achieves an ACPR of  $-75$  dBc at  $-5$  dBm output, at which point device noise and not distortion is beginning to dominate the power in the adjacent channels. At an output power of  $+5$  dBm, ACPR is still very low at  $-61$  dBc, making the device particularly suitable for PA driver applications.

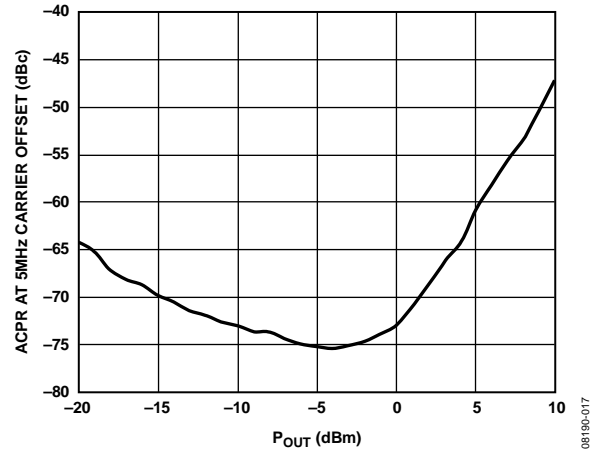

Figure 18. ACPR vs.  $P_{OUT}$ , Single Carrier W-CDMA (Test Model 1-64) at 2140 MHz Evaluation Board

### EVALUATION BOARD

Figure 20 shows the schematic for the ADL5602 evaluation board. The board is powered by a single 5 V supply.

The components used on the board are listed in Table 6. Power can be applied to the board through clip-on leads (VCC and GND).

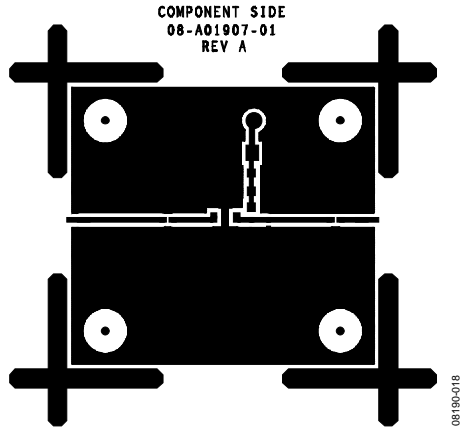

Figure 19. Evaluation Board Layout (Top)

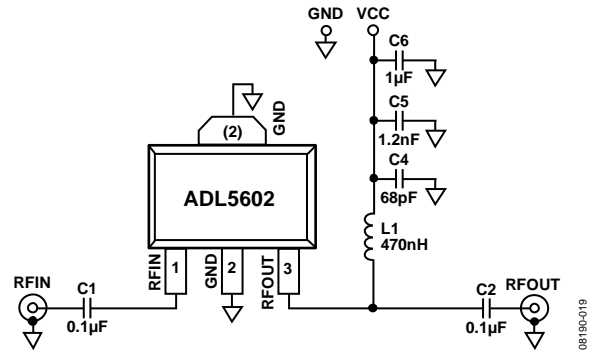
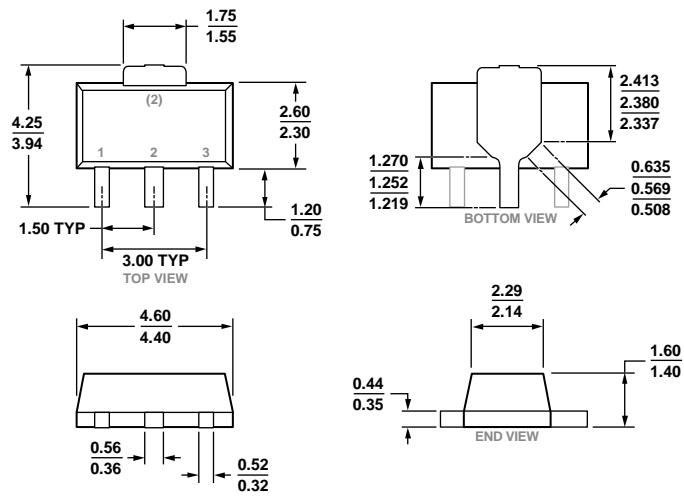

Figure 20. Evaluation Board Schematic

Table 6. Evaluation Board Configuration Options

Component	Description	Default Value
C1, C2	AC-coupling capacitors	0.1 μF, 0402
L1	DC bias inductor	470 nH, 0603 (Coilcraft 0603LS-NX or equivalent)
VCC and GND	Clip-on terminals for power supply	
C4, C5, C6	Power supply decoupling capacitors	C4 = 68 pF, 0603; C5 = 1.2 nF, 0603; C6 = 1 μF, 1206

# OUTLINE DIMENSIONS



COMPLIANT TO JEDEC STANDARDS TO-243

Figure 21. 3-Lead Small Outline Transistor Package [SOT-89] (RK-3)  
Dimensions shown in millimeters

## ORDERING GUIDE

Model <sup>1</sup>	Temperature Range	Package Description	Package Option
ADL5602ARKZ-R7	-40°C to +85°C	3-Lead SOT-89, 7" Tape and Reel	RK-3
ADL5602-EVALZ		Evaluation Board	

<sup>1</sup> Z = RoHS Compliant Part.

**NOTES**



Компания «Океан Электроники» предлагает заключение долгосрочных отношений при поставках импортных электронных компонентов на взаимовыгодных условиях!

Наши преимущества:

- Поставка оригинальных импортных электронных компонентов напрямую с производств Америки, Европы и Азии, а так же с крупнейших складов мира;
- Широкая линейка поставок активных и пассивных импортных электронных компонентов (более 30 млн. наименований);
- Поставка сложных, дефицитных, либо снятых с производства позиций;
- Оперативные сроки поставки под заказ (от 5 рабочих дней);
- Экспресс доставка в любую точку России;
- Помощь Конструкторского Отдела и консультации квалифицированных инженеров;
- Техническая поддержка проекта, помощь в подборе аналогов, поставка прототипов;
- Поставка электронных компонентов под контролем ВП;
- Система менеджмента качества сертифицирована по Международному стандарту ISO 9001;
- При необходимости вся продукция военного и аэрокосмического назначения проходит испытания и сертификацию в лаборатории (по согласованию с заказчиком);
- Поставка специализированных компонентов военного и аэрокосмического уровня качества (Xilinx, Altera, Analog Devices, Intersil, Interpoint, Microsemi, Actel, Aeroflex, Peregrine, VPT, Syfer, Eurofarad, Texas Instruments, MS Kennedy, Miteq, Cobham, E2V, MA-COM, Hittite, Mini-Circuits, General Dynamics и др.);

Компания «Океан Электроники» является официальным дистрибьютором и эксклюзивным представителем в России одного из крупнейших производителей разъемов военного и аэрокосмического назначения «**JONHON**», а так же официальным дистрибьютором и эксклюзивным представителем в России производителя высокотехнологичных и надежных решений для передачи СВЧ сигналов «**FORSTAR**».



## JONHON

«**JONHON**» (основан в 1970 г.)

Разъемы специального, военного и аэрокосмического назначения:

(Применяются в военной, авиационной, аэрокосмической, морской, железнодорожной, горно- и нефтедобывающей отраслях промышленности)

«**FORSTAR**» (основан в 1998 г.)

ВЧ соединители, коаксиальные кабели, кабельные сборки и микроволновые компоненты:

(Применяются в телекоммуникациях гражданского и специального назначения, в средствах связи, РЛС, а так же военной, авиационной и аэрокосмической отраслях промышленности).



Телефон: 8 (812) 309-75-97 (многоканальный)

Факс: 8 (812) 320-03-32

Электронная почта: [ocean@oceanchips.ru](mailto:ocean@oceanchips.ru)

Web: <http://oceanchips.ru/>

Адрес: 198099, г. Санкт-Петербург, ул. Калинина, д. 2, корп. 4, лит. А