

ABC450 Series

AC-DC Open Frame Power Supplies

The ABC450 Series of open-frame power supplies, with its wide universal 90-264 VAC input range and high power density, is available at 450 W of output power and a variety of single and multiple output voltages.

The high efficiency and high power density of the ABC family ensures minimal power loss in end-use equipment, thereby facilitating higher reliability, easier thermal management and meets regulatory approvals for environmentally-friendly end products.

These medical power supplies are ideal for monitoring, home health equipment as well as surgical devices.



Key Features & Benefits

- 4 x 6.5 x 1.61 inches
- Universal AC Input
- 450 W (with airflow), 300 W (without airflow)
- Current Sharing Option
- Cover and Fan Options
- Peak Power Capability
- Low Standby Power
- Side Fan or Top Fan Mounting Option Product
- (-S or -T to be added to model number)
- Current Sharing Option Product (-I to be added to model number)
- ITE Safety Agency Approvals
- RoHS Compliant
- CE marked

Applications

- Instrumentation
- Lighting
- Industrial Applications
- Test and Measurement
- Robotics
- Renewable Energy
- Data Communication
- Applied Computing



bel POWER
SOLUTIONS &
PROTECTION

a bel group

belfuse.com/power-solutions

1. MODEL SELECTION

MODEL	OUTPUT VOLTAGE	MAX LOAD (CONVECTION) ^{1,2,3}	MAX LOAD (420 LFM) ^{1,2,3}	MINIMUM LOAD	RIPPLE & NOISE ⁴
ABC450-1T05G	5 VDC	31.0 A	55.0 A	0.0 A	2%
ABC450-1T12G	12 VDC	20.83 A	37.5 A	0.0 A	2%
ABC450-1T15G	15 VDC	16.66 A	30.0 A	0.0 A	2%
ABC450-1T24G	24 VDC	12.30 A	18.75 A	0.0 A	2%
ABC450-1T30G	30 VDC	10.0 A	15.0 A	0.0 A	2%
ABC450-1T48G	48 VDC	6.25 A	9.37 A	0.0 A	2%

2. INPUT SPECIFICATIONS

Specifications are for nominal input voltage, 25°C unless otherwise stated.

PARAMETER	DESCRIPTION / CONDITION	SPECIFICATIONS
Input Voltage	Universal	90-264 VAC / 120-390 VDC
Input Frequency		47 to 63 Hz
Input Current	120 VAC: 230 VAC:	4.5 A max. 2.3 A max.
No Load Power	120 VAC: 230 VAC:	0.4 W 0.8 W
Inrush Current	120 VAC: 230 VAC:	40 A max. 75 A max.
Leakage Current	Earth Leakage Current Touch Leakage Current	270 µA 45 µA @120 VAC / 63 Hz
Input Protection	Dual fusing, in AC Line and AC Neutral	T8A / 250 V
Power Factor	120 VAC 230 VAC	0.98 0.95
Switching Frequency	PFC converter: Variable Resonant converter: Variable	45-160 kHz typical 35-250 kHz, 90 kHz typical

¹ Combined output power of main output, fan supply and standby supply shall not exceed max. power rating

² Standby output voltage 5 V / 1.5 A (convection) / 2 A (420LFM) with tolerance including set point accuracy, line and load regulation is +/-10%. Ripple and noise is less than 5%.

³ Fan supply output voltage 12 V / 500 mA with tolerance including set point accuracy, line and load regulation is +/-30% and needs min. 1% load on main output to be within regulation band. Ripple and noise is less than 10%.

⁴ Ripple is peak to peak with 20 MHz bandwidth and 10 µF (Tantalum capacitor) in parallel with a 0.1 µF capacitor at rated line voltage and load ranges. Please contact factory/ sales representative for minimum load required for ripple to be within specification.

3. OUTPUT SPECIFICATIONS

PARAMETER	DESCRIPTION / CONDITION		SPECIFICATIONS
Output Power ⁵	475 W for 24 V, 30 V & 500 W for 48 V model only for 5 seconds max.		155 to 450 W
Efficiency (Full Load)	120 VAC	24 V, 48 V, 30 V 12 V, 15 V 5 V	88% 86% 83% typical
	230 VAC	24 V, 48 V, 30 V	90%
Hold Up Time	120 / 230 VAC		10 ms
Line Regulation			+/-0.5%
Load Regulation			+/-3%
Transient Response	<10%, 50% to 100% load change, 50 Hz, 50% duty cycle, 0.1 A/μs		Recovery time < 5 ms
Rise Time			< 100 ms
Set Point Tolerance			+/-1%
Voltage Adjustment	V1		± 3 %
Over Voltage Protection	Latch Type		>114%
Over Current Protection	Hic-Up type		120 to 150%
Short Circuit Protection	Short term, auto recovery		
Over Temperature Protection	Automatic recovery		130°C primary heat sink
Current Share	Up to 2 supplies connected in parallel (optional)		

4. SIGNALS

PARAMETER	DESCRIPTION / CONDITION
Power Good Signal	TTL signal goes high after main output is within regulation band, delay is 0.1 to 0.3 s
Remote Sense	Compensates for 200 mV drop
Remote on/off	To turn on PSU short remote pin to ground

5. EMC SPECIFICATIONS

PARAMETER	DESCRIPTION / CONDITION	SPECIFICATION
Conducted Emissions	EN55032-B, CISPR22-B, FCC PART15-B	Pass
Radiated Emissions	EN 55032 A; with external core (King core K5B RC 25x12x15-M in input cable)	Pass Level B
Input Current Harmonics	EN 61000-3-2	Class D
Voltage Fluctuation and Flicker	EN 61000-3-3	Pass
ESD Immunity	EN 61000-4-2	Level 3, Criterion A
Radiated Field Immunity	EN 61000-4-3	Level 3, Criterion A
Electrical Fast Transient Immunity	EN 61000-4-4	Level 3, Criterion A
Surge Immunity	EN 61000-4-5	Level 3, Criterion A
Conducted Immunity	EN 61000-4-6	Level 3, Criterion A
Magnetic Field Immunity	EN 61000-4-8	Level 3, Criterion A
Voltage Dips, Interruptions	EN 61000-4-11	Criterion A & B

⁵ Derate output power linearly to 80% from 90 VAC to 80 VAC input.

6. ENVIRONMENTAL SPECIFICATIONS

PARAMETER	DESCRIPTION / CONDITION	SPECIFICATIONS
Operating Temperature	Refer to derating curve (<i>Figure 1</i>)	0 to +70°C
Storage Temperature		-40 to 85° C
Humidity	Non Condensing	95% HR
Altitude	Operating: Non-Operating:	10,000 ft. 40,000 ft.
Cooling	5 V model	Convection: 155 W 420 LFM: 275 W
	12 V & 15 V models	Convection: 250 W 420 LFM: 450 W
	24 V, 30 V & 48 V models	Convection: 300 W 420 LFM: 450 W
Reliability	MTBF according to Telcordia -SR332-Issue 3	1.28 million hours

7. SAFETY SPECIFICATIONS

PARAMETER	DESCRIPTION / CONDITION	SPECIFICATION
Isolation Voltage	Input to Output Input to Earth	4242 VDC 2121 VDC
Safety Standards	Approved to the latest edition of the following standards: CSA/UL60950-1, EN60950-1 and IEC60950-1; Class1 SELV	
Agency Approvals	Nemko, Nemko-CCL	
CE mark	Complies with LVD Directive	

8. CONNECTOR & PIN DESCRIPTION

CONNECTOR	PIN	DESCRIPTION / CONDITION	MANUFACTURER / PN
AC Input Connector	J1	Pin 1 AC line Pin 3 AC neutral Pin 5 Earth	Tyco: 1-1123724-3 Mating: 1-1123722-5
DC Output Connector	J2	Lug 1 +V1 Lug 2 RTN	6-32 inches Screw Pan HD Mating: 16 AWG wire crimped to Ring Tongue Terminal AMP: 8-31886-1
Signals ⁶	J3	Pin 1 NC Pin 2 Power Fail Pin 3 Power Good Pin 4 DC Return Pin 5 +5Vstby Pin 6 +VE Remote Sense Pin 7 -VE Remote Sense Pin 8 CS Pin 9 DC Return Pin 10 Remote On/Off	Molex: 22-23-2081 Mating: 22-01-2087; Pins: 08-50-0113
Fan	J4	Pin 1 +VE Pin 2 -VE	Mating Connector: Molex 22-01-2025 Pins = 08-50-0113
Earth ⁷	J5		Molex: 19705-4301 Mating: 190030001

⁶ PSU is supplied with J3, pin-9 and pin-10 shorted to enable main output without remote on/off feature

⁷ The J5 (Earth) spade connector can be used for U-Channel option products only. When fan options are required the earth connection provided in the input AC connector should be used (Pin 5 – J1)

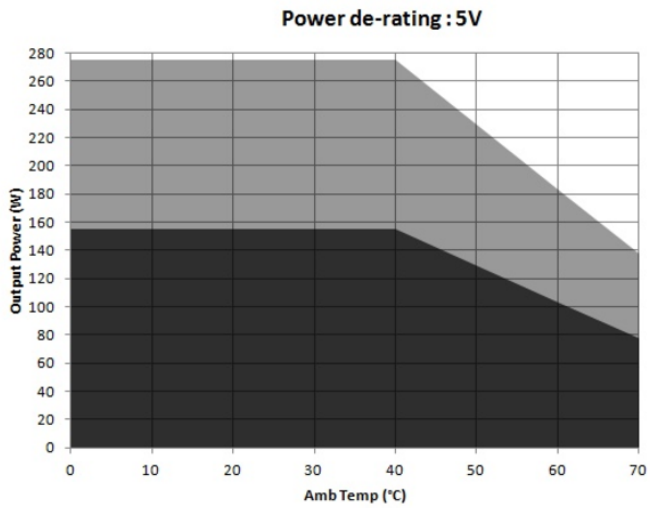

Convection load: 155 W up to 40 °C
De-rate above 40 °C @ 1.67% per °C

Forced air cooled load: 275 W up to 40°C
De-rate above 40 °C @ 1.67% per °C



Convection load: 250 W up to 40 °C
De-rate above 40 °C @ 1.67% per °C

Forced air cooled load: 450 W up to 40°C
De-rate above 40 °C @ 1.67% per °C

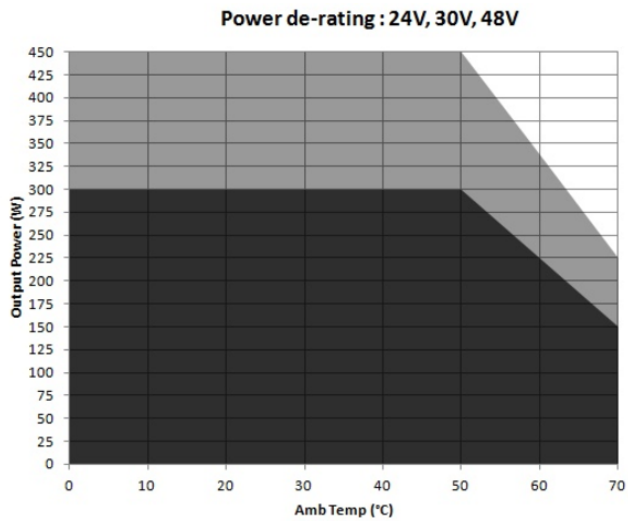

Convection load: 300 W up to 50 °C
De-rate above 50 °C @ 2.5% per °C

Forced air cooled load: 450 W up to 50°C
De-rate above 50 °C @ 2.5% per °C

Figure 1. Derating Curves

9. MECHANICAL SPECIFICATIONS

PARAMETER	DESCRIPTION / CONDITION
Weight	900 g (1.98 lbs)
Dimensions	101.6 x 165.0 x 41.0 mm (4.0 x 6.5 x 1.6 inch)

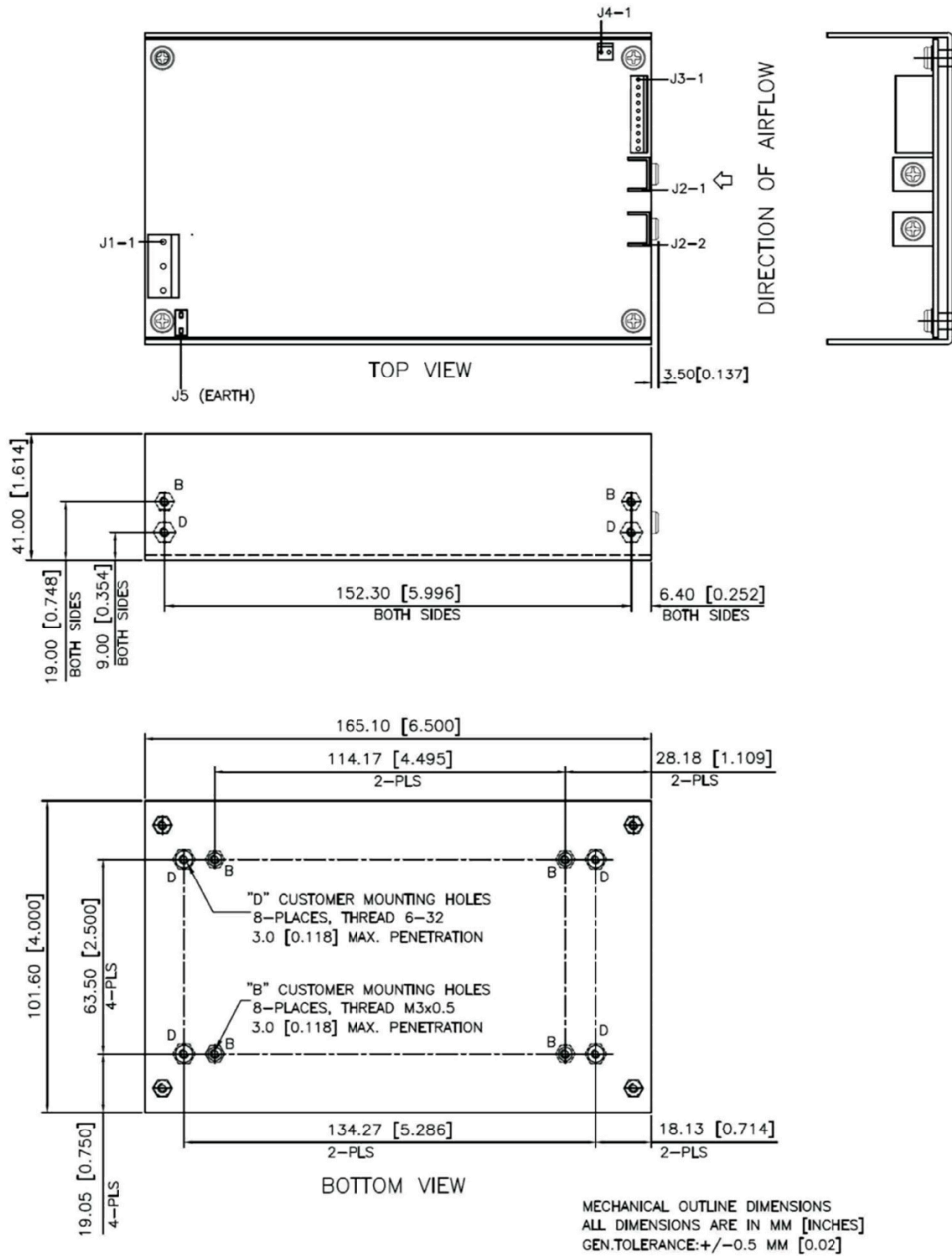

Figure 2. Mechanical Drawing (Without Fan Mounting)

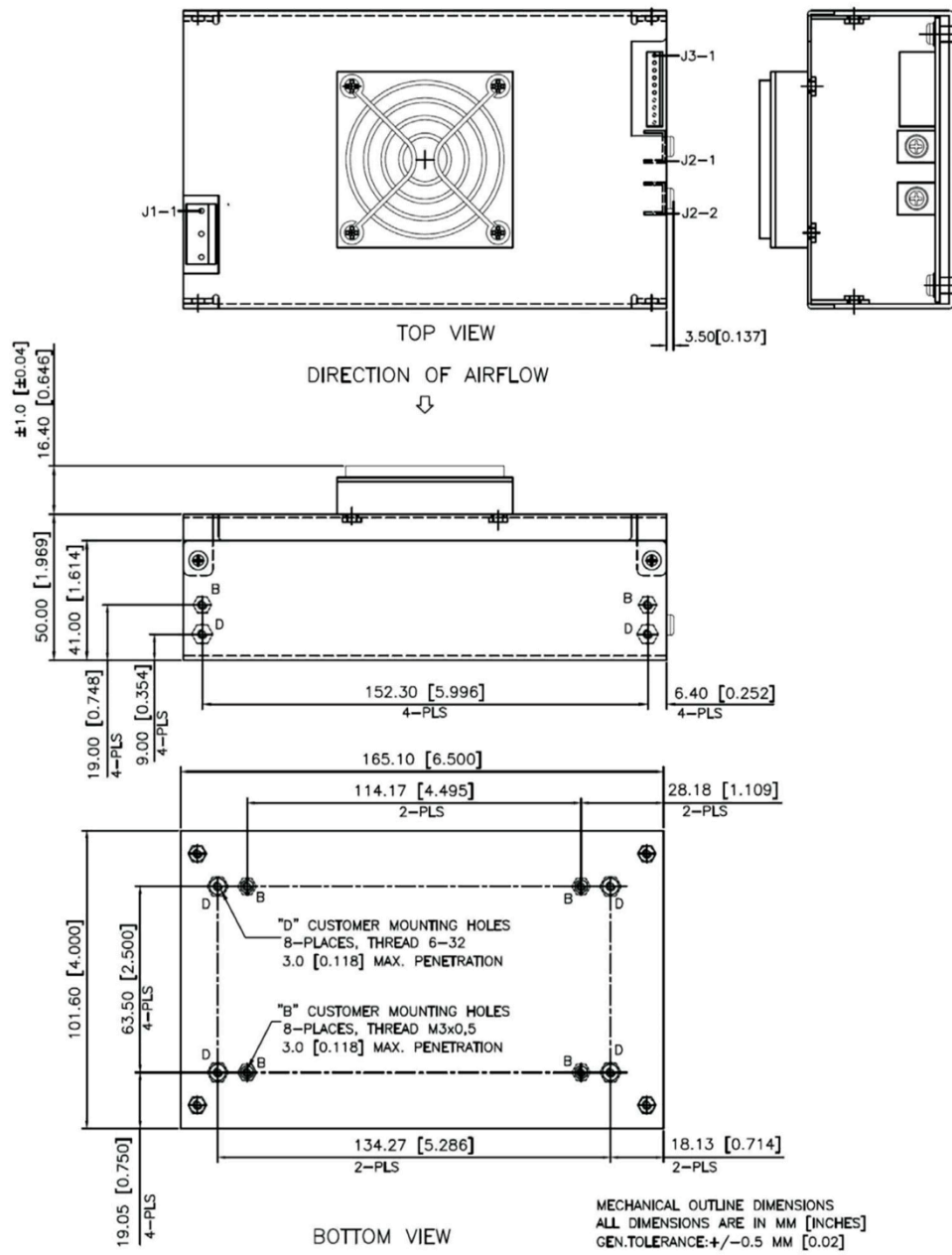

Figure 3 - Mechanical Drawing (With Top Fan Mounting)

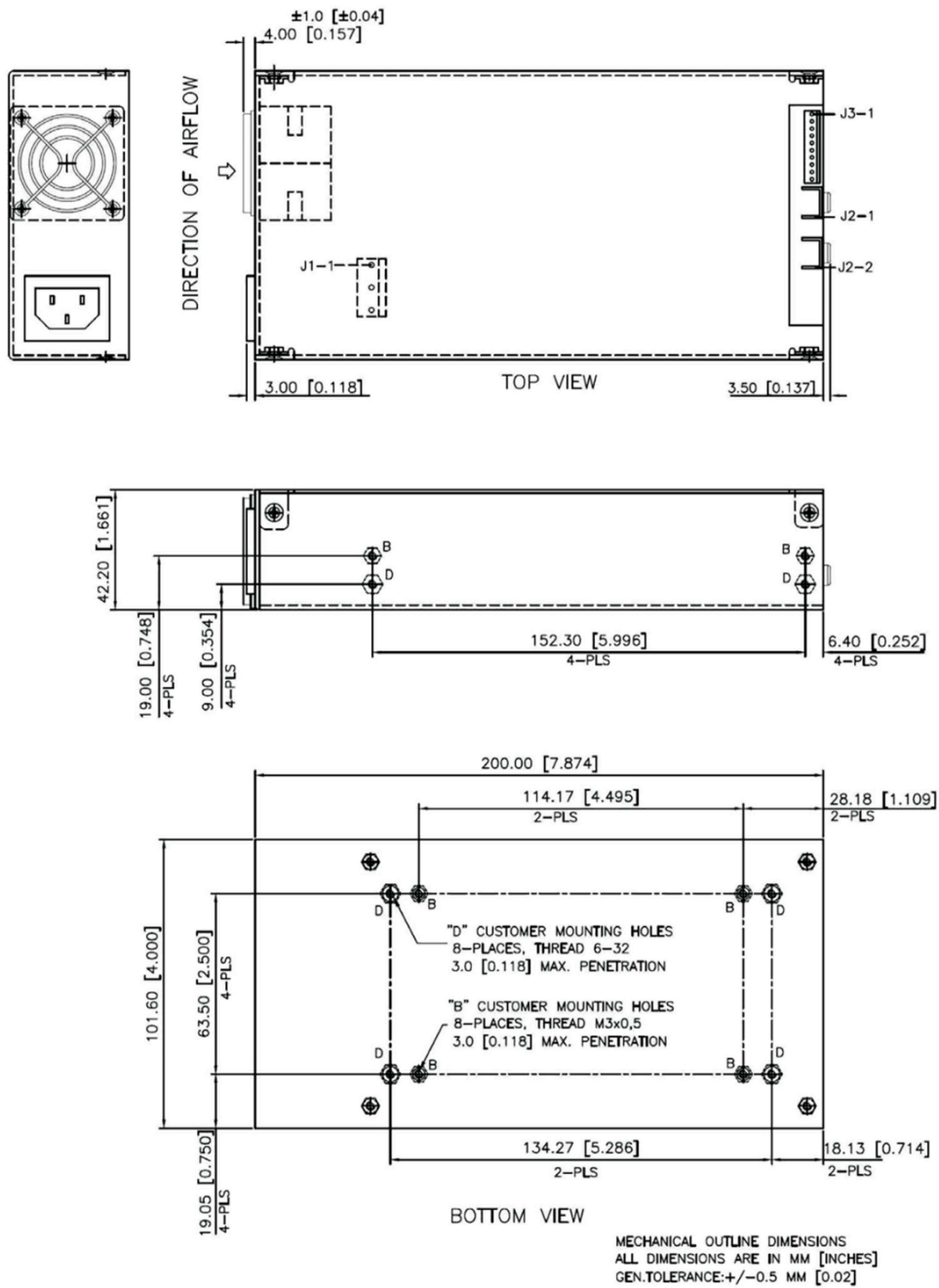

Figure 4 - Mechanical Drawing (With Side Fan Mounting)

10. INSTALLATION INSTRUCTION FOR CURRENT SHARING

During the installation and setup of parallel supplies in a system it is important that a single remote sense point be used for all the supplies.

The remote sense voltage between the supplies must be adjusted to within 2% to ensure the supplies are inside the 3% capture window.

If the supplies are not initially adjusted inside the capture window the supplies will not current share.

NOTE:

“CURRENT SHARING “ facility is inclusive with the unit only with ordering of the “ CURRENT SHARING “ option unit i.e. ABC450-1XXX-I or ABC450-1XXX-I.

SET-UP PROCEDURE:

- 1 Connect load cables to the outputs of each supply.
- 2 Connect the remote sense lines to the load in twisted style. (A common remote sense point must be used for all the supplies in parallel).
- 3 Connect all the “current share” pins on the J3 connector between the supplies.
- 4 Adjust remote sense voltage of each supply to within 1% of rated output voltage or readjust to required set point. (Adjustment to be done with all other parallel supplies off).
- 5 Current sharing between the supplies can be verified by monitoring the output current of each supply with a hall effect DC current probe. The supplies should share to within 10% of the total load current.
- 6 The current share circuit has a capture window voltage of +/- 3% of the rated output voltage. If the output remote sense voltage of one of the supplies is adjusted outside the 3% window the supplies will not current share.

CURRENT SHARING BLOCK DIAGRAM

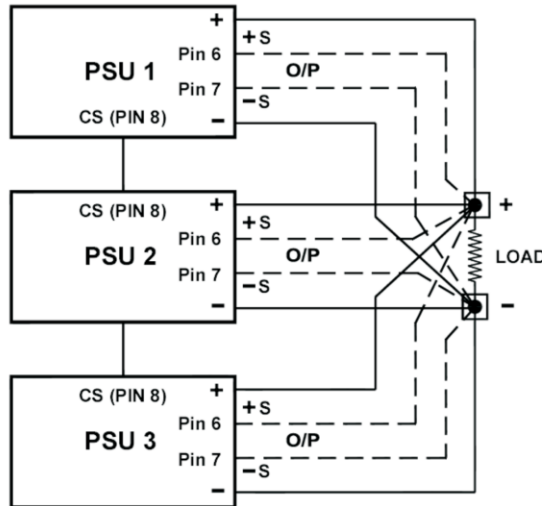

For more information on these products consult: tech.support@psbel.com

NUCLEAR AND MEDICAL APPLICATIONS - Products are not designed or intended for use as critical components in life support systems, equipment used in hazardous environments, or nuclear control systems.

TECHNICAL REVISIONS - The appearance of products, including safety agency certifications pictured on labels, may change depending on the date manufactured. Specifications are subject to change without notice.

Компания «Океан Электроники» предлагает заключение долгосрочных отношений при поставках импортных электронных компонентов на взаимовыгодных условиях!

Наши преимущества:

- Поставка оригинальных импортных электронных компонентов напрямую с производств Америки, Европы и Азии, а так же с крупнейших складов мира;
- Широкая линейка поставок активных и пассивных импортных электронных компонентов (более 30 млн. наименований);
- Поставка сложных, дефицитных, либо снятых с производства позиций;
- Оперативные сроки поставки под заказ (от 5 рабочих дней);
- Экспресс доставка в любую точку России;
- Помощь Конструкторского Отдела и консультации квалифицированных инженеров;
- Техническая поддержка проекта, помощь в подборе аналогов, поставка прототипов;
- Поставка электронных компонентов под контролем ВП;
- Система менеджмента качества сертифицирована по Международному стандарту ISO 9001;
- При необходимости вся продукция военного и аэрокосмического назначения проходит испытания и сертификацию в лаборатории (по согласованию с заказчиком);
- Поставка специализированных компонентов военного и аэрокосмического уровня качества (Xilinx, Altera, Analog Devices, Intersil, Interpoint, Microsemi, Actel, Aeroflex, Peregrine, VPT, Syfer, Eurofarad, Texas Instruments, MS Kennedy, Miteq, Cobham, E2V, MA-COM, Hittite, Mini-Circuits, General Dynamics и др.);

Компания «Океан Электроники» является официальным дистрибьютором и эксклюзивным представителем в России одного из крупнейших производителей разъемов военного и аэрокосмического назначения «JONHON», а так же официальным дистрибьютором и эксклюзивным представителем в России производителя высокотехнологичных и надежных решений для передачи СВЧ сигналов «FORSTAR».



JONHON

«JONHON» (основан в 1970 г.)

Разъемы специального, военного и аэрокосмического назначения:

(Применяются в военной, авиационной, аэрокосмической, морской, железнодорожной, горно- и нефтедобывающей отраслях промышленности)

«FORSTAR» (основан в 1998 г.)

ВЧ соединители, коаксиальные кабели,
кабельные сборки и микроволновые компоненты:

(Применяются в телекоммуникациях гражданского и специального назначения, в средствах связи, РЛС, а так же военной, авиационной и аэрокосмической отраслях промышленности).



Телефон: 8 (812) 309-75-97 (многоканальный)

Факс: 8 (812) 320-03-32

Электронная почта: ocean@oceanchips.ru

Web: <http://oceanchips.ru/>

Адрес: 198099, г. Санкт-Петербург, ул. Калинина, д. 2, корп. 4, лит. А