

W3150A+ Datasheet

Ver. 2.0.4



© 2006 WIZnet Co., Ltd. All Rights Reserved.

For more information, visit our website at <http://www.wiznet.co.kr>

Document History Information

Revision	Date	Description
Ver. 1.0.0	OCT 27, 2005	Release with W3150A Launching
Ver. 1.0.1	NOV 21, 2005	Replace, 1.8V operation → 3.3V operation (p.3) Change block diagram (p.4) Change figure (p.32) Replace, g_Sn_TX_BASE → g_Sn_RX_BASE (p.33) Replace, memcpy(, ,left_size) → in memcpy(, ,upper_size) (p.40, p.41, p.47, p.48, p.49) Replace, get_offset = Sn_TX_RR & → get_offset = Sn_TX_WR & (p.41, p.49) Replace, SOCK_UDP → SOCK_IPRAW (p.51)
Ver. 1.0.2	DEC 28, 2005	Add 7.3 Power Dissipation (p.56)
Ver. 2.0.0	AUG 15, 2006	New version release (W3150A -> W3150A+) Add SPI Information Added ND option in socket mode register Remove Memory test mode Add MACRAW mode
Ver. 2.0.1	JAN 8, 2007	LB bit in Mode register is not used . W3150A+ used in Big-endian ordering only.
Ver. 2.0.2	APR 5, 2007	Change Operating temperature value (p.57)
Ver. 2.0.3	May 2, 2007	Modify explanation of RECV_INT in Sn_IR register (P. 27) Replace reset value of Sn_DHAR register (0x00 to 0xFF, P. 30) Modify explanation of Sn_DIPR, Sn_DPORT register(P. 30) Replace reset value of Sn_MSS register (0xFFFF to 0x0000, P. 31) Modify figure of W3150A+ AC Characteristics(P. 58,59,60,62,63)
Ver. 2.0.4	Oct 5, 2007	Modify figure of W3150A+ AC Characteristics (Added item NO.7 SCLK high to /SS high, P. 61)

WIZnet's Online Technical Support

If you have something to ask about WIZnet Products, Write down your question on Q&A Board of 'Support' menu in WIZnet website (www.wiznet.co.kr). WIZnet Engineer will give an answer as soon as possible.

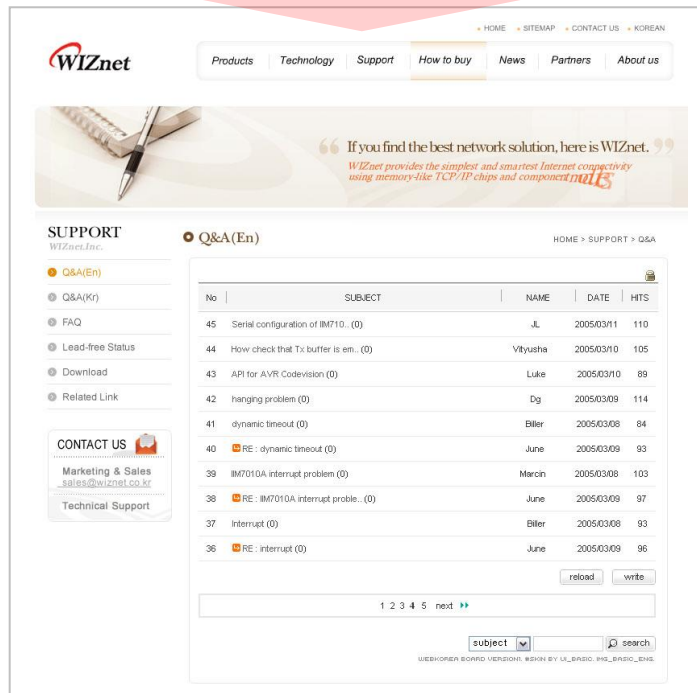

W3150A+ Datasheet

Description

The W3150A+ is an LSI of hardware protocol stack that provides an easy, low-cost solution for high-speed Internet connectivity for digital devices by allowing simple installation of TCP/IP stack in the hardware.

The W3150A+ offers a quick and easy way to add Ethernet networking functionality to any products. Implementing this LSI into a system can completely provide Internet connectivity and process standard protocols by significantly reducing the software development cost as well development time which is most important in today time-to market.

The W3150A+ contains TCP/IP Protocol Stacks such as TCP, UDP, ICMP, IPv4, ARP and PPPoE protocols, as well as Ethernet protocols such as MAC protocol. The total internal memory size is 16Kbytes, which is used as the buffer for data transmission and receipt.

The W3150A+ provides three different interfaces like direct, indirect bus interfaces and SPI(Serial Peripheral Interface) to connect with MCUs and standard MII(Media Independent Interface) composed of nibble data bus to connect with Ethernet PHY devices.

The W3150A+ is a best-fitted device for embedded application including IP-Settop Box, Internet-DVR, Internet phones, VoIP SOC chips, Internet MP3 players, handheld medical devices, various industrial system for monitoring and metering, and any other non-portable electronic devices such as large consumer electronic products.

Features

- Support Hardwired TCP/IP Protocols : TCP, UDP, ICMP, IGMP, IPv4, ARP, PPPoE, Ethernet
- Support ADSL connection (with support PPPoE Protocol with PAP/CHAP Authentication mode)
- Supports 4 independent sockets simultaneously
- Not support IP Fragmentation
- Standard MII Interface for Ethernet-PHY chip
- Supports 10BaseT/100BaseTX
- Supports full-duplex mode
- Internal 16Kbytes Memory for Tx/Rx Buffers
- 0.18 μ m CMOS technology
- 3.3V operation with 5V I/O signal tolerance
- Small 64 Pin LQFP Package
- Lead-Free Package
- Support Serial Peripheral Interface(SPI MODE 0, 3)

Block Diagram

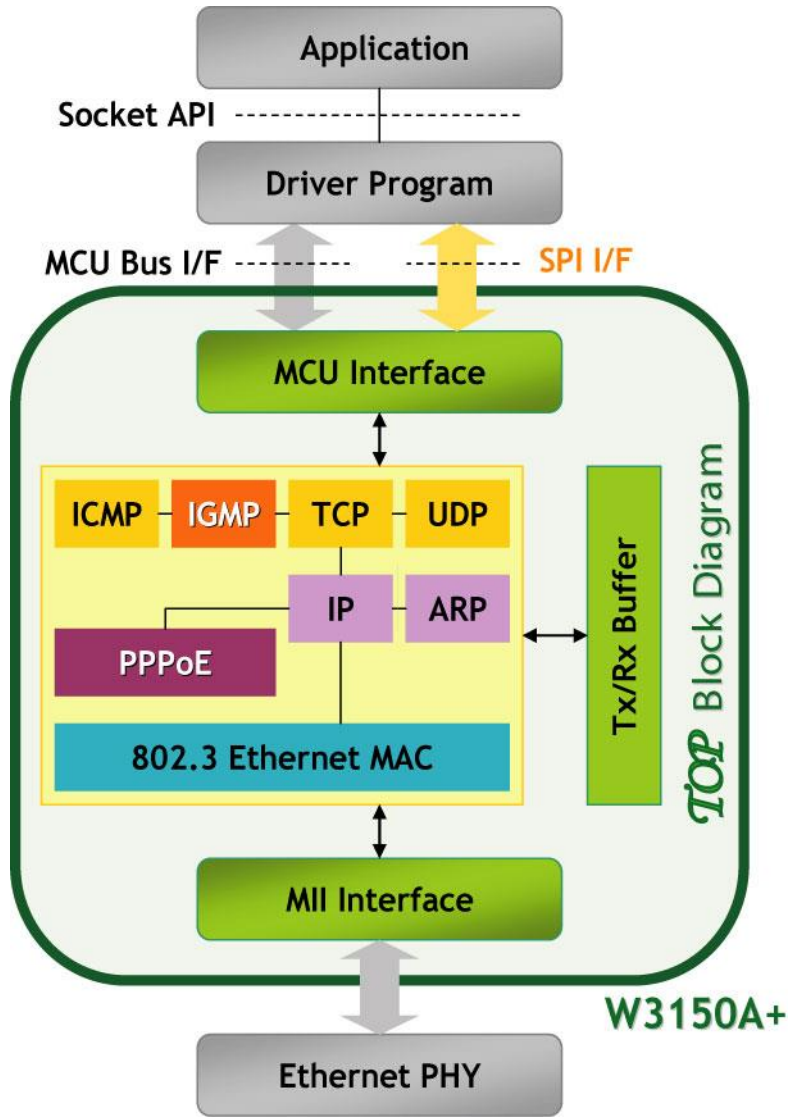

Table of Contents

Description	3
Features	3
Block Diagram	4
Table of Contents	5
1. Pin Assignment	7
1.1. MII Signal Description.....	8
1.2. MCU Interface Signal Description	9
1.3. Miscellaneous Signal Description	11
1.4. Power Supply Signal Description.....	12
2. Memory map	13
3. W3150A+ Registers.....	14
3.1. Common Registers	14
3.2. Socket Registers	15
4. Register Descriptions	19
4.1. Common Registers	19
4.2. Socket Registers	25
5. Functional Description	35
5.1. Initialization	35
5.2. Data communication	37
5.2.1. TCP	37
5.2.2. UDP	45
5.2.3. IP raw	50
5.2.4. MAC raw	52
6. Application Information	53
6.1. Direct Bus I/F Mode.....	53
6.2. Indirect Bus I/F Mode.	53
6.3. Serial Peripheral Interface (SPI) Mode	54
6.4. MII (Media Independent Interface).....	56
7. Electrical Specification	57
7.1. Absolute Maximum Ratings	57
7.2. DC Characteristics	57
7.3. POWER DISSIPATION.....	57
7.4. AC Characteristics	58
7.4.1. Reset Timing	58
7.4.2. Register/Memory READ Timing.....	59



7.4.3.	Register/Memory WRITE Timing	60
7.4.4.	SPI Timing	61
7.4.5.	MII(Media Independent Interface) Timing.....	62
8.	IR Reflow Temperature Profile (Lead-Free)	64
9.	Package Description	65

1. Pin Assignment

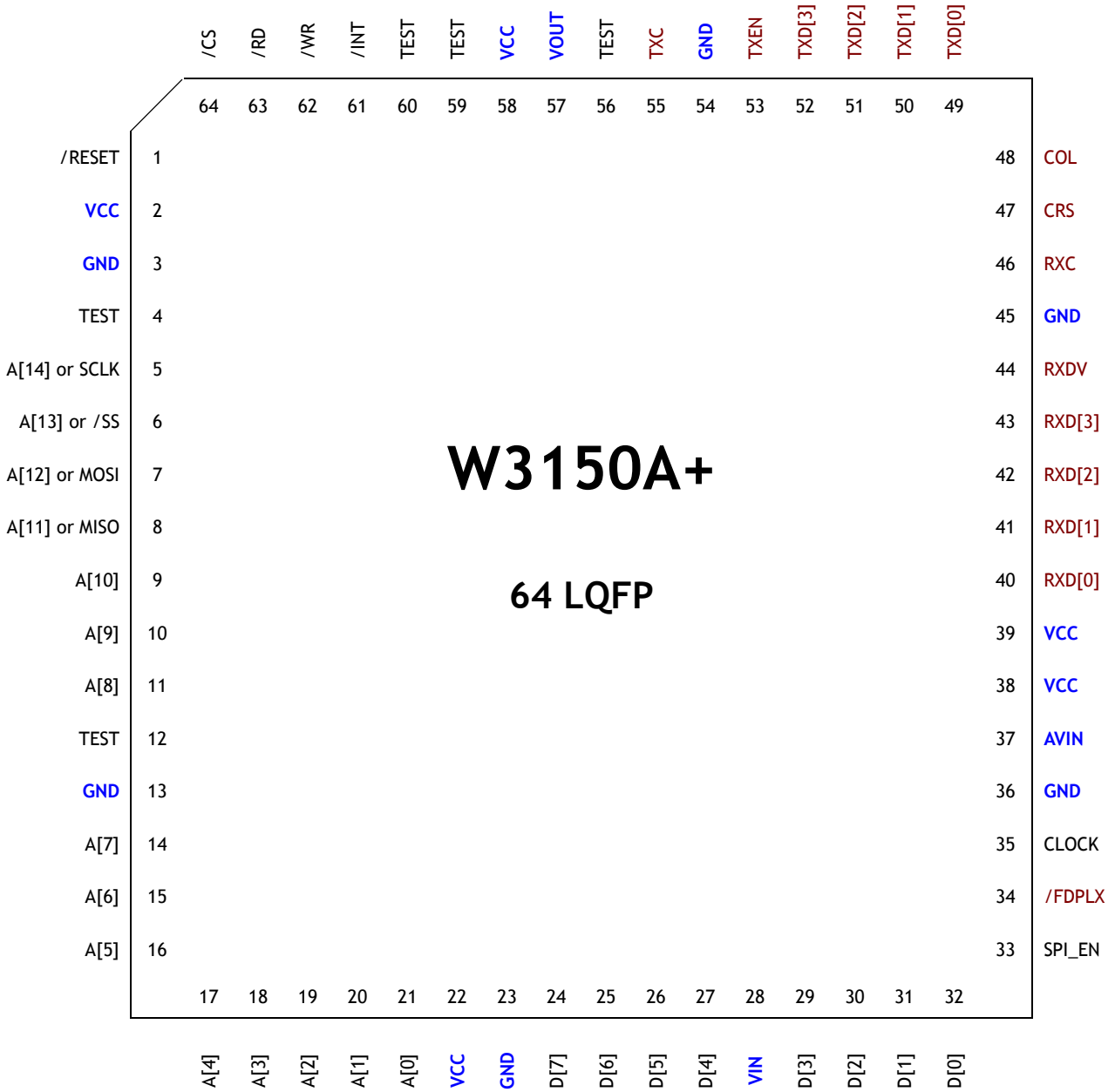

1.1. MII Signal Description

Pin#	Signal	I/O	Description
55	TXC	I	Transmit Clock This input pin needs a continuous clock as timing reference for TXD[3:0] and TXEN. TXC is supplied by the PHY. TXC is 2.5 MHz in 10 BASE-T nibble mode, and 25MHz in 100BASE-TX nibble mode.
53	TXEN	O	Transmit Enable This output signal indicates the presence of a valid nibble data on TXD[3:0]. It becomes active when the first nibble data of the packet is valid on TXD[3:0] and goes low after the last nibble data of the packet is clocked out of TXD[3:0]. This signal connects directly to the PHY device. This signal is active high.
52 51 50 49	TXD[3] TXD[2] TXD[1] TXD[0]	O	Transmit Data These pins transmit Nibble NRZ data to the PHY synchronously with TXC when TXEN is asserted.
46	RXC	I	Receive Clock This input pin needs a continuous clock as timing reference for RXDV and RXD[3:0] signals. RXC is supplied by the PHY. RXC is 2.5MHz in 10BASE-T nibble mode, and 25MHz in 100BASE-TX nibble mode.
48	COL	I	Collision Detect The active high signal at this input pin indicates that a collision has been detected in Half-Duplex modes. This signal is asynchronous and is ignored during full-duplex operation.
47	CRS	I	Carrier Sense The active high signal at this input pin detects that carrier is present.
44	RXDV	I	Receive Data Valid If signal is detected high on this input pin, valid data is present on the RXD[3:0]. If signal is detected low at the end of the valid packet, the signal is valid on the rising of the RXC.
43 42 41 40	RXD[3] RXD[2] RXD[1] RXD[0]	I	Receive Data These pins receive Nibble NRZ data from the PHY device synchronously with RXC when RXDV is asserted.

1.2. MCU Interface Signal Description

Pin#	Signal	I/O	Description
1	/RESET	I	RESET This pin is active Low input to initialize or re-initialize W3150A+. Asserting this pin low for at least 2us will force a reset process to occur which will result in all internal registers re-initializing to their default states.
35	CLOCK	I	CLOCK This pin is the Primary clock required for internal operation of W3150A+. 25MHz is required. In general, PHY driving clock can be shared for saving cost. <i>Note) Sharing crystal source clock with multiple devices may cause some troubles. In our reference design, we used one crystal for both PHY and W3150A+ with verification.</i> <i>But for other kind of PHY, please confirm safety prior to decision.</i>
5	A[14]/ SCLK	I	ADDRESS PIN or SCLK (Serial Clock) * This pin is used to select a register or memory. When asserting SPI_EN pin high, this pin is used to SPI Clock signal Pin.
6	A[13]/ /SS	I	ADDRESS PIN or /SS (Slave Select) * This pin is used to select a register or memory. When asserting SPI_EN pin high, this pin is used to SPI Slave Select signal Pin. In only SPI Mode, this pin is active low
7	A[12]/ MOSI	I	ADDRESS PIN or MOSI (Master Out Slave In) * This pin is used to select a register or memory. When asserting SPI_EN pin high, this pin is used to SPI MOSI signal pin.
8	A[11]/ MISO	I/O	ADDRESS PIN or MISO (Master In Slave Out) * This pin is used to select a register or memory. When asserting SPI_EN pin high, this pin is used to SPI MISO signal pin.
9:11 14:21	A[10:8] A[7:0]	I	ADDRESS PINS These pins are used to select a register or memory.
24:27, 29:32	D[7:4] D[3:0]	I/O	DATA PINS These pins are used to read and write register or memory data.

* Difference from W3150A

61	/INT	0	INTERRUPT This pin Indicates that W3150A+ requires MCU attention after socket connecting, disconnecting, receiving data or timeout. The interrupt is cleared by writing IR(Interrupt Register) or Sn_IR (Socket nth Interrupt Register). All interrupts are maskable. This signal is active low.
64	/CS	I	CHIP SELECT Chip Select is for MCU access to internal registers/memory. /WR and /RD select direction of data transfer. This signal is active low.
62	/WR	I	WRITE ENABLE Strobe from MCU to write an internal register/memory selected by A[14:0]. Data is latched into the W3150A+ on the rising edge of this input. This signal is active low.
63	/RD	I	READ ENABLE Strobe from MCU to read an internal register/memory selected by A[14:0]. This signal is active low.

1.3. Miscellaneous Signal Description

Pin#	Signal	I/O	Description
34	/FDPLX	I	FULL/HALF DUPLEX SELECT This pin selects Half/Full Duplex operation mode. This pin must be externally pulled low (typically x kΩ) in order to configure the W3150A+ for Full Duplex operation. Low = Full Duplex High = Half Duplex
33	SPI_EN	I	SPI Enable* This pin selects Enable/disable of the SPI Mode. This pin is internally pulled down for previous W3150A users. Even if there is no signal connection to this pin, it asserts low internally. Thereby, in case of change to W3150A+, there is no effort to change previous board design. Low = SPI Mode Disable High = SPI Mode Enable
4,12,56, 59,60	TEST	I	FACTORY TEST INPUT Used to check the chip's internal functions. This should be tied low (pull-down) during normal operation.

* * Difference from W3150A

1.4. Power Supply Signal Description

Pin#	Signal	I/O	Description
2, 22, 38, 39, 58	VCC		POSITIVE 3.3V SUPPLY PINS
28	VIN		1.8V power input 1.8V power supply
37	AVIN		1.8V Analog power input 1.8V power supply for analog circuit ; should be well decoupled. Refer Figure 1-1. Reference Schematic for Power input.
57	VOUT		1.8V power out Be sure to connect 10uF tantalum capacitor and a 0.1uF capacitor for noise de-coupling. Then connect this pin through a ferrite bead to VIN and AVIN.
3, 13, 23, 36, 45, 54	GND		NEGATIVE (GROUND) SUPPLY PINS

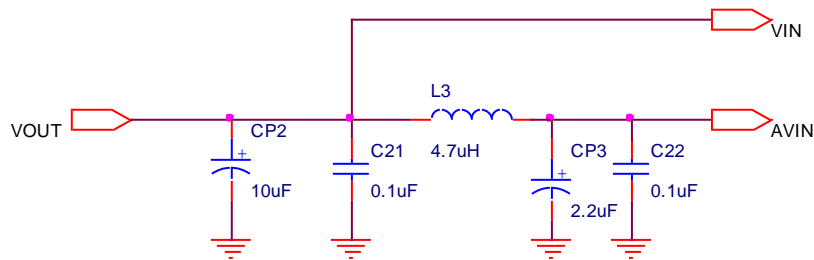
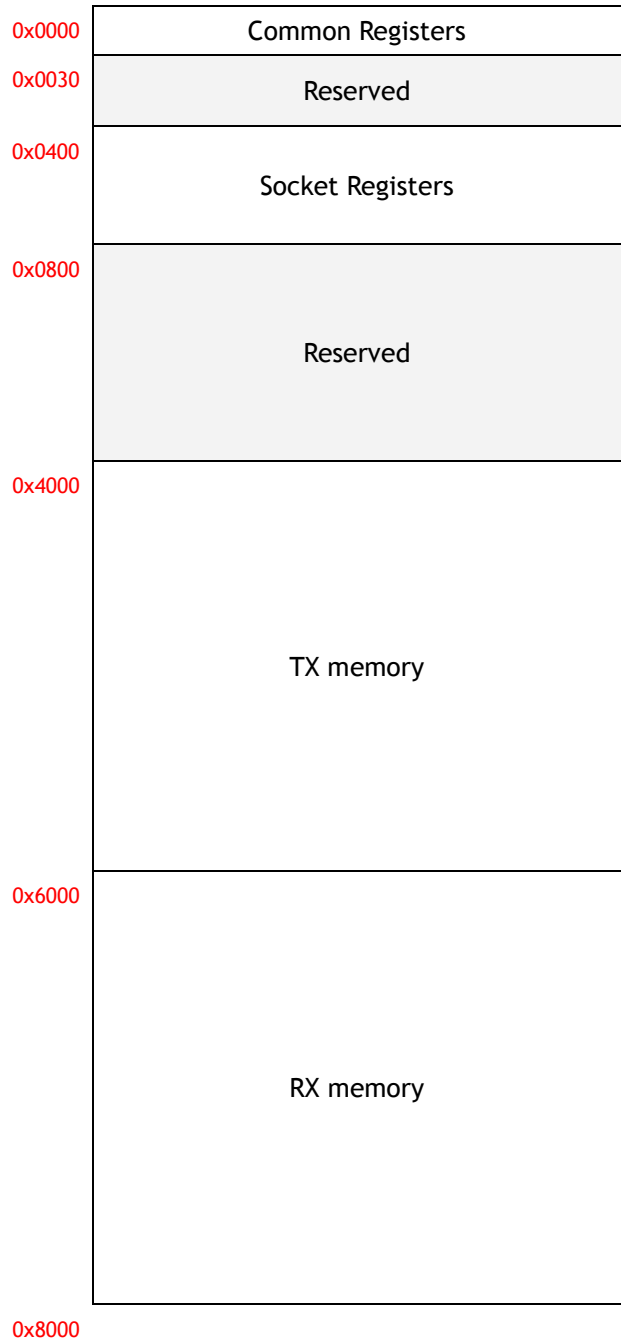

Figure 1-1. Reference Schematic for Power input



2. Memory map

W3150A+ is composed of Common Register, Socket Register, TX Memory, and RX Memory. Each fields are shown as below.



3. W3150A+ Registers

3.1. Common Registers

Address	Register
0x0000	Mode (MR)
0x0001	Gateway Address (GAR0)
0x0002	(GAR1)
0x0003	(GAR2)
0x0004	(GAR3)
0x0005	Subnet mask Address (SUBR0)
0x0006	(SUBR1)
0x0007	(SUBR2)
0x0008	(SUBR3)
0x0009	Source Hardware Address (SHAR0)
0x000A	(SHAR1)
0x000B	(SHAR2)
0x000C	(SHAR3)
0x000D	(SHAR4)
0x000E	(SHAR5)
0x000F	Source IP Address (SIPR0)
0x0010	(SIPR1)
0x0011	(SIPR2)
0x0012	(SIPR3)
0x0013	Reserved
0x0014	
0x0015	Interrupt (IR)
0x0016	Interrupt Mask (IMR)
0x0017	Retry Time (RTR0)
0x0018	(RTR1)
0x0019	Retry Count (RCR)

Address	Register
0x001A	RX Memory Size (RMSR)
0x001B	TX Memory Size (TMSR)
0x001C	Authentication Type in PPPoE (PATR0)
0x001D	(PATR1)
0x001E	
-	Reserved
0x0027	
0x0028	PPP LCP Request Timer (PTIMER)
0x0029	PPP LCP Magic number (PMAGIC)
0x002A	Unreachable IP Address (UIPR0)
0x002B	(UIPR1)
0x002C	(UIPR2)
0x002D	(UIPR3)
0x002E	Unreachable Port (UPORT0)
0x002F	(UPORT1)
0x0030	
-	Reserved
0x03FF	

3.2. Socket Registers

Address	Register
0x0400	Socket 0 Mode (S0_MR)
0x0401	Socket 0 Command (S0_CR)
0x0402	Socket 0 Interrupt (S0_IR)
0x0403	Socket 0 Status (S0_SR)
0x0404	Socket 0 Source Port (S0_PORT0)
0x0405	(S0_PORT1)
0x0406	Socket 0 Destination Hardware Address (S0_DHAR0)
0x0407	(S0_DHAR1)
0x0408	(S0_DHAR2)
0x0409	(S0_DHAR3)
0x040A	(S0_DHAR4)
0x040B	(S0_DHAR5)
0x040C	Socket 0 Destination IP Address (S0_DIPR0)
0x040D	(S0_DIPR1)
0x040E	(S0_DIPR2)
0x040F	(S0_DIPR3)
0x0410	Socket 0 Destination Port (S0_DPORT0)
0x0411	(S0_DPORT1)
0x0412	Socket 0 Maximum Segment Size (S0_MSSR0)
0x0413	(S0_MSSR1)
0x0414	Socket 0 Protocol in IP Raw mode (S0_PROTO)

Address	Register
0x0415	Socket 0 IP TOS (S0_TOS)
0x0416	Socket 0 IP TTL (S0_TTL)
0x0417	Reserved
-	
0x041F	Socket 0 TX Free Size (S0_TX_FSR0)
0x0420	
0x0421	(S0_TX_FSR1)
0x0422	Socket 0 TX Read Pointer (S0_TX_RD0)
0x0423	(S0_TX_RD1)
0x0424	Socket 0 TX Write Pointer (S0_TX_WR0)
0x0425	(S0_TX_WR1)
0x0426	Socket 0 RX Received Size (S0_RX_RSR0)
0x0427	(S0_RX_RSR1)
0x0428	Socket 0 RX Read Pointer (S0_RX_RD0)
0x0429	(S0_RX_RD1)
0x042A	Reserved
0x042B	
0x042C	Reserved
-	
0x04FF	

Address	Register
0x0500	Socket 1 Mode (S1_MR)
0x0501	Socket 1 Command (S1_CR)
0x0502	Socket 1 Interrupt (S1_IR)
0x0503	Socket 1 Status (S1_SR)
0x0504	Socket 1 Source Port (S1_PORT0)
0x0505	(S1_PORT1)
0x0506	Socket 1 Destination Hardware Address (S1_DHAR0)
0x0507	(S1_DHAR1)
0x0508	(S1_DHAR2)
0x0509	(S1_DHAR3)
0x050A	(S1_DHAR4)
0x050B	(S1_DHAR5)
0x050C	Socket 1 Destination IP Address (S1_DIPR0)
0x050D	(S1_DIPR1)
0x050E	(S1_DIPR2)
0x050F	(S1_DIPR3)
0x0510	Socket 1 Destination Port (S1_DPORT0)
0x0511	(S1_DPORT1)
0x0512	Socket 1 Maximum Segment Size (S1_MSSR0)
0x0513	(S1_MSSR1)
0x0514	Socket 1 Protocol in IP Raw mode (S1_PROTO)

Address	Register
0x0515	Socket 1 IP TOS (S1_TOS)
0x0516	Socket 1 IP TTL (S1_TTL)
0x0517	Reserved
0x051F	
0x0520	Socket 1 TX Free Size (S1_TX_FSR0)
0x0521	(S1_TX_FSR1)
0x0522	Socket 1 TX Read Pointer (S1_TX_RD0)
0x0523	(S1_TX_RD1)
0x0524	Socket 1 TX Write Pointer (S1_TX_WR0)
0x0525	(S1_TX_WR1)
0x0526	Socket 1 RX Received Size (S1_RX_RSR0)
0x0527	(S1_RX_RSR1)
0x0528	Socket 1 RX Read Pointer (S1_RX_RD0)
0x0529	(S1_RX_RD1)
0x052A	Reserved
0x052B	
0x052C	Reserved
0x05FF	

Address	Register
0x0600	Socket 2 Mode (S2_MR)
0x0601	Socket 2 Command (S2_CR)
0x0602	Socket 2 Interrupt (S2_IR)
0x0603	Socket 2 Status (S2_SR)
0x0604	Socket 2 Source Port (S2_PORT0)
0x0605	(S2_PORT1)
0x0606	Socket 2 Destination Hardware Address (S2_DHAR0)
0x0607	(S2_DHAR1)
0x0608	(S2_DHAR2)
0x0609	(S2_DHAR3)
0x060A	(S2_DHAR4)
0x060B	(S2_DHAR5)
0x060C	Socket 2 Destination IP Address (S2_DIPRO)
0x060D	(S2_DIPR1)
0x060E	(S2_DIPR2)
0x060F	(S2_DIPR3)
0x0610	Socket 2 Destination Port (S2_DPORT0)
0x0611	(S2_DPORT1)
0x0612	Socket 2 Maximum Segment Size (S2_MSSR0)
0x0613	(S2_MSSR1)
0x0614	Socket 2 Protocol in IP Raw mode (S2_PROTO)

Address	Register
0x0615	Socket 2 IP TOS (S2_TOS)
0x0616	Socket 2 IP TTL (S2_TTL)
0x0617	Reserved
0x061F	
0x0620	Socket 2 TX Free Size (S2_TX_FSR0)
0x0621	(S2_TX_FSR1)
0x0622	Socket 2 TX Read Pointer (S2_TX_RD0)
0x0623	(S2_TX_RD1)
0x0624	Socket 2 TX Write Pointer (S2_TX_WR0)
0x0625	(S2_TX_WR1)
0x0626	Socket 2 RX Received Size (S2_RX_RSR0)
0x0627	(S2_RX_RSR1)
0x0628	Socket 2 RX Read Pointer (S2_RX_RD0)
0x0629	(S2_RX_RD1)
0x062A	Reserved
0x062B	
0x062C	Reserved
0x06FF	

Address	Register
0x0700	Socket 3 Mode (S3_MR)
0x0701	Socket 3 Command (S3_CR)
0x0702	Socket 3 Interrupt (S3_IR)
0x0703	Socket 3 Status (S3_SR)
0x0704	Socket 3 Source Port (S3_PORT0)
0x0705	(S3_PORT1)
0x0706	Socket 3 Destination Hardware Address (S3_DHAR0)
0x0707	(S3_DHAR1)
0x0708	(S3_DHAR2)
0x0709	(S3_DHAR3)
0x070A	(S3_DHAR4)
0x070B	(S3_DHAR5)
0x070C	Socket 3 Destination IP Address (S3_DIPR0)
0x070D	(S3_DIPR1)
0x070E	(S3_DIPR2)
0x070F	(S3_DIPR3)
0x0710	Socket 3 Destination Port (S3_DPORT0)
0x0711	(S3_DPORT1)
0x0712	Socket 3 Maximum Segment Size (S3_MSSR0)
0x0713	(S3_MSSR1)
0x0714	Socket 3 Protocol in IP Raw mode (S3_PROTO)

Address	Register
0x0715	Socket 3 IP TOS (S3_TOS)
0x0716	Socket 3 IP TTL (S3_TTL)
0x0717	Reserved
- 0x071F	
0x0720	Socket 3 TX Free Size (S3_TX_FSR0)
0x0721	(S3_TX_FSR1)
0x0722	Socket 3 TX Read Pointer (S3_TX_RD0)
0x0723	(S3_TX_RD1)
0x0724	Socket 3 TX Write Pointer (S3_TX_WR0)
0x0725	(S3_TX_WR1)
0x0726	Socket 3 RX Received Size (S3_RX_RSR0)
0x0727	(S3_RX_RSR1)
0x0728	Socket 3 RX Read Pointer (S3_RX_RD0)
0x0729	(S3_RX_RD1)
0x072A	Reserved
0x072B	
0x072C	Reserved
- 0x07FF	

4. Register Descriptions

4.1. Common Registers

MR (Mode Register) [R/W] [0x0000] [0x00]¹

This register is used for S/W Reset, memory test mode, ping block mode, PPPoE mode and Indirect bus I/F.

7	6	5	4	3	2	1	0
RST			PB	PPPoE		AI	IND

Bit	Symbol	Description
7	RST	S/W Reset If this bit is '1', internal register will be initialized. It will be automatically cleared after reset.
6	Reserved	Reserved
5	Reserved	Reserved
4	PB	Ping Block Mode 0 : Disable Ping block 1 : Enable Ping block If the bit is set as '1', there is no response to the ping request.
3	PPPoE	PPPoE Mode 0 : Disable PPPoE mode 1 : Enable PPPoE mode If you use ADSL without router or etc, you should set the bit as '1', and connect to ADSL Server. For more detail, refer to the application note, "How to connect ADSL".
2	Not used	Not used.
1	AI	Address Auto-Increment in Indirect Bus I/F 0 : Disable auto-increment 1 : Enable auto-increment At the Indirect Bus I/F mode, if this bit is set as '1', the address will be automatically increased by 1 whenever Read and Write are performed. For more detail, refer to 6.1.2 Indirect Bus IF Mode.
0	IND	Indirect Bus I/F mode 0 : Disable Indirect bus I/F mode

¹ [Read/Write] [Address] [Reset value]

		1 : Enable Indirect bus I/F mode If this bit is set as '1', Indirect BUS I/F mode is set. For more detail, refer to 6. Application Information, 6.1.2. Indirect Bus IF Mode.
--	--	---

GWR (Gateway IP Address Register) [R/W] [0x0001 - 0x0004] [0x00]

This Register sets up the default gateway address.

Ex) in case of "192.168.0.1"

0x0001	0x0002	0x0003	0x0004
192 (0xC0)	168 (0xA8)	0 (0x00)	1 (0x01)

SUBR (Subnet Mask Register) [R/W] [0x0005 - 0x0008] [0x00]

This register sets up the subnet mask address.

Ex) in case of "255.255.255.0"

0x0005	0x0006	0x0007	0x0008
255 (0xFF)	255 (0xFF)	255 (0xFF)	0 (0x00)

SHAR (Source Hardware Address Register) [R/W] [0x0009 - 0x000E] [0x00]

This register sets up the Source Hardware address.

Ex) In case of "00.08.DC.01.02.03"

0x0009	0x000A	0x000B	0x000C	0x000D	0x000E
0x00	0x08	0xDC	0x01	0x02	0x03

SIPR (Source IP Address Register) [R/W] [0x000F - 0x0012] [0x00]

This register sets up the Source IP address.

Ex) in case of "192.168.0.3"

0x000F	0x0010	0x0011	0x0012
192 (0xC0)	168 (0xA8)	0 (0x00)	3 (0x03)

IR (Interrupt Register) [R] [0x0015] [0x00]

This register is accessed by the host processor to know the cause of an interrupt.

Any interrupt can be masked in the Interrupt Mask Register (IMR). The /INT signal retain low as long as any masked signal is set, and will not go high until all masked bits in this Register have been cleared.

7	6	5	4	3	2	1	0
CONFLICT	UNREACH	PPPoE	Reserved	S3_INT	S2_INT	S1_INT	S0_INT

Bit	Symbol	Description
7	CONFLICT	IP Conflict It is set as '1', when there is ARP request with same IP address as Source IP address. This bit is cleared to '0' by writing '1' to this bit.*
6	UNREACH	Destination unreachable W3150A+ will receive ICMP(Destination Unreachable) packet if not-existing destination IP address is transmitted during UDP data transmission. (Refer to 5.2.2. UDP). In this case, the IP address and the port number will be saved in Unreachable IP Address (UIPR) and Unreachable Port Register (UPORT), and the bit will be set as '1'. This bit will be cleared to '0' by writing '1' to this bit.*
5	PPPoE	PPPoE Close In the PPPoE Mode, if the PPPoE connection is closed, '1' is set. This bit will be cleared to '0' by writing '1' to this bit.*
4	Reserved	Reserved
3	S3_INT	Occurrence of Socket 3 Socket Interrupt It is set in case that interrupt occurs at the socket 3. For more detailed information of socket interrupt, refer to "Socket 3 Interrupt Register (S3_IR). This bit will be automatically cleared when S3_IR is cleared to 0x00.
2	S2_INT	Occurrence of Socket 2 Socket Interrupt It is set in case that interrupt occurs at the socket 2. For more detailed information of socket interrupt, refer to "Socket 2 Interrupt Register(S2_IR). This bit will be automatically cleared when S2_IR is cleared to 0x00.
1	S1_INT	Occurrence of Socket 1 Socket Interrupt It is set in case that interrupt occurs at the socket 1. For more detailed information of socket interrupt, refer to "Socket 1 Interrupt Register (S1_IR). This bit will be automatically cleared when S1_IR is cleared to 0x00.

* Difference from W3150A

0	SO_INT	Occurrence of Socket 0 Socket Interrupt It is set in case that interrupt occurs at the socket 0. For more detailed information of socket interrupt, refer to “Socket 0 Interrupt Register (SO_IR). This bit will be automatically cleared when SO_IR is cleared to 0x00.
---	--------	--

IMR (Interrupt Mask Register) [R/W] [0x0016] [0x00]

The Interrupt Mask Register is used to mask interrupts. Each interrupt mask bit corresponds to a bit in the Interrupt Register (IR). If an interrupt mask bit is set, an interrupt will be issued whenever the corresponding bit in the IR is set. If any bit in the IMR is set as ‘0’, an interrupt will not occur though the bit in the IR is set.

7	6	5	4	3	2	1	0
IM_IR7	IM_IR6	IM_IR5	Reserved	IM_IR3	IM_IR2	IM_IR1	IM_IR0

Bit	Symbol	Description
7	IM_IR7	IP Conflict Enable
6	IM_IR6	Destination unreachable Enable
5	IM_IR5	PPPoE Close Enable
4	Reserved	It should be set as ‘0’
3	IM_IR3	Occurrence of Socket 3 Socket Interrupt Enable
2	IM_IR2	Occurrence of Socket 2 Socket Interrupt Enable
1	IM_IR1	Occurrence of Socket 1 Socket Interrupt Enable
0	IM_IR0	Occurrence of Socket 0 Socket Interrupt Enable

RTR (Retry Time-value Register) [R/W] [0x0017 - 0x0018] [0x07D0]

This register sets the period of timeout. Value 1 means 100us. The initial value is 2000(0x07D0). That will be set as 200ms.

Ex) For 400ms configuration, set as 4000(0x0FA0)

0x0017	0x0018
0x0F	0xA0

Re-transmission will occur if there is no response from the remote peer to the commands of CONNECT, DISCON, CLOSE, SEND, SEND_MAC and SEND_KEEP, or the response is delayed.

RCR (Retry Count Register) [R/W] [0x0019] [0x08]

This register sets the number of re-transmission. If retransmission occurs more than the number recorded in RCR, Timeout Interrupt (TIMEOUT bit of Socket *n* Interrupt Register (Sn_IR) is set as '1') will occur.

RMSR(RX Memory Size Register) [R/W] [0x001A] [0x55]

This register assigns total 8K RX Memory to each socket.

	7	6	5	4	3	2	1	0
Socket 3		Socket 2		Socket 1		Socket 0		
S1	S0	S1	S0	S1	S0	S1	S0	

The memory size according to the configuration of S1, S0, is as below.

S1	S0	Memory size
0	0	1KB
0	1	2KB
1	0	4KB
1	1	8KB

According to the value of S1 and S0, the memory is assigned to the sockets from socket 0 within the range of 8KB. If there is not enough memory to be assigned, the socket should not be used. The initial value is 0x55 and the 2K memory is assigned to each 4 sockets respectively.

Ex) When setting as 0xAA, the 4KB memory should be assigned to each socket.

However, the total memory size is 8KB. The memory is normally assigned to the socket 0 and 1, but not to the socket 2 and 3. Therefore, socket 2 and 3 are not absolutely used.

Socket 3	Socket 2	Socket 1	Socket 0
0KB	0KB	4KB	4KB

TMSR(TX Memory Size Register) [R/W] [0x001B] [0x55]

This register is used in assigning total 8K TX Memory to sockets. Configuration can be done in the same way of RX Memory Size Register (RMSR). The initial value is 0x55 and it is to assign 2K memory to 4 sockets respectively.

PATR (Authentication Type in PPPoE mode) [R] [0x001C-0x001D] [0x0000]

This register notifies authentication method that has been agreed at the connection with PPPoE Server. W3150A+ supports two types of Authentication method - PAP and CHAP.

Value	Authentication Type
0xC023	PAP
0xC223	CHAP

PTIMER (PPP Link Control Protocol Request Timer Register) [R/W] [0x0028] [0x28]

This register indicates the duration for sending LCP Echo Request. Vaule 1 is about 25ms.

Ex) in case that PTIMER is 200,

$$200 * 25(\text{ms}) = 5000(\text{ms}) = 5 \text{ seconds}$$

PMAGIC (PPP Link Control Protocol Magic number Register) [R/W] [0x0029] [0x00]

This register is used in Magic number option during LCP negotiation. Refer to the application note, "How to connect ADSL".

UIPR (Unreachable IP Address Register) [R] [0x002A - 0x002D] [0x00]

In case of data transmission by using UDP (refer to 5.2.2. UDP), if transmitting to non-existing IP address, ICMP (Destination Unreachable) packet will be received. In this case, that IP address and port number will be respectively saved in the Unreachable IP Address Register(UIPR) and Unreachable Port Register(UPOINT).

Ex) in case of "192.168.0.11",

0x002A	0x002B	0x002C	0x002D
192 (0xC0)	168 (0xA8)	0 (0x00)	11 (0x0B)

UPOINT (Unreachable Port Register) [R] [0x002E - 0x002F] [0x0000]

Refer to Unreachable IP Address Register (UIPR)

Ex) In case of 5000(0x1388),

0x002E	0x002F
0x13	0x88

4.2. Socket Registers

Sn^1 _MR (Socket n Mode Register) [R/W] [0x0400, 0x0500, 0x0600, 0x0700] [0x00]²

This register sets up socket option or protocol type for each socket.

7	6	5	4	3	2	1	0
MULTI		ND / MC		P3	P2	P1	P0

Bit	Symbol	Description
7	MULTI	<p>Multicasting 0 : disable Multicasting 1 : enable Multicasting It is applied only in case of UDP. For using multicasting, write multicast group address to Socket n Destination IP and multicast group port number to Socket n Destination Port Register, before OPEN command.</p>
6	Reserved	Reserved
5	ND/MC	<p>Use No Delayed ACK 0 : Disable No Delayed ACK option 1 : Enable No Delayed ACK option, It is applied only in case of TCP. If this bit is set as '1', ACK packet is transmitted whenever receiving data packet from the peer. If this bit is cleared to '0', ACK packet is transmitted according to internal Timeout mechanism.</p> <p>Multicast 0 : using IGMP version 2 1 : using IGMP version 1 It is applied only in case of MULTI bit is '1'</p>
4	Reserved	Reserved

¹ n is socket number (0, 1, 2, 3).

² [Read/Write] [address of socket 0, address of socket 1, address of socket 2, address of socket 3] [Reset value]

3	P3	Protocol				
		Sets up corresponding socket as TCP, UDP, or IP RAW mode				
2	P2	P3	P2	P1	P0	Meaning
		0	0	0	0	Closed
		0	0	0	1	TCP
1	P1	0	0	1	0	UDP
		0	0	1	1	IPRAW
0	P0	* In case of socket 0, MACRAW and PPPoE mode exist.				
		P3	P2	P1	P0	Meaning
		0	1	0	0	MACRAW
		0	1	0	1	PPPoE

Sn_CR (Socket n Command Register) [R/W] [0x0401, 0x0501, 0x0601, 0x0701] [0x00]

This register is utilized for socket *n* initialization, close, connection establishment, termination, data transmission and command receipt. After performing the commands, the register value will be automatically cleared to 0x00.

Value	Symbol	Description
0x01	OPEN	It is used to initialize the socket. According to the value of Socket <i>n</i> Mode Register (<i>Sn_MR</i>), Socket <i>n</i> Status Register(<i>Sn_SR</i>) value is changed to SOCK_INIT, SOCK_UDP, SOCK_IPRAW, or SOCK_MACRAW. For more detail, refer to 5. Functional Description.
0x02	LISTEN	It is only used in TCP mode. It changes the value of Socket <i>n</i> Status Register (<i>Sn_SR</i>) to SOCK_LISTEN in order to wait for a connection request from any remote peer (TCP Client). For more detail, refer to 5.2.1.1. SERVER.
0x04	CONNECT	It is only used in TCP mode. It sends a connection request to remote peer(TCP SERVER). If the connection is failed, Timeout interrupt will occur. For more detail, refer to 5.2.1.2. CLIENT.
0x08	DISCON	It is only used in TCP mode. It sends a connection termination request. If connection termination is failed, Timeout interrupt will occur. For more detail, refer to 5.2.1.1. SERVER. <i>* In case of using CLOSE command instead of DISCON, only the value of Socket n Status Register(Sn_SR) is changed to SOCK_CLOSED without the connection termination process.</i>

0x10	CLOSE	It is used to close the socket. It changes the value of Socket <i>n</i> Status Register(<i>Sn_SR</i>) to SOCK_CLOSED.
0x20	SEND	It transmits the data as much as the increased size of Socket <i>n</i> TX Write Pointer. For more detail, refer to Socket <i>n</i> TX Free Size Register (<i>Sn_TX_FSR</i>), Socket <i>n</i> TX Write Pointer Register(<i>Sn_TX_WR</i>), and Socket <i>n</i> TX Read Pointer Register(<i>Sn_TX_RR</i>) or 5.2.1.1. SERVER.
0x21	SEND_MAC	It is used in UDP mode. The basic operation is same as SEND. Normally SEND operation needs Destination Hardware Address that is received in ARP(Address Resolution Protocol) process. SEND_MAC uses Socket <i>n</i> Destination Hardware Address(<i>Sn_DHAR</i>) that is written by users without ARP process.
0x22	SEND_KEEP	It is only used in TCP mode. It checks the connection status by sending 1byte data. If the connection is already terminated or peer has no response, Timeout interrupt will occur.
0x40	RECV	Receiving is processed with the value of Socket <i>n</i> RX Read Pointer Register(<i>Sn_RX_RD</i>). For more detail, refer to 5.2.1.1. SERVER Receiving Process with Socket <i>n</i> RX Received Size Register (<i>Sn_RX_RSR</i>), Socket <i>n</i> RX Write Pointer Register(<i>Sn_RX_WR</i>), and Socket <i>n</i> RX Read Pointer Register(<i>Sn_RX_RD</i>)

Sn_IR (Socket *n* Interrupt Register) [R] [0x0402, 0x0502, 0x0602, 0x0702] [0x00]

This register is used for notifying connection establishment and termination, receiving data and Timeout.

The Socket *n* Interrupt Register must be cleared by **writing '1'**. *

7	6	5	4	3	2	1	0
Reserved	Reserved	Reserved	SEND_OK	TIMEOUT	RECV	DISCON	CON

Bit	Symbol	Description
7	Reserved	Reserved
6	Reserved	Reserved
5	Reserved	Reserved
4	SEND_OK	It is set as '1' if send operation is completed.**
3	TIMEOUT	It is set as '1' if Timeout occurs during connection establishment or termination and data transmission.
2	RECV	It is set as '1' whenever w3150a+ receives data.

* Difference from W3150A

** SEND_OK Interrupt is added in W3150A+

		And it is also set as '1' if received data remains after CMD_RECV executes.
--	--	---

1	DISCON	It is set as '1' if connection termination is requested or finished.
0	CON	It is set as '1' if connection is established.

Sn_SR (Socket n Status Register) [R] [0x0403, 0x0503, 0x0603, 0x0703] [0x00]

This register has the status vaule of socket *n*. The main status is shown in the below diagram.

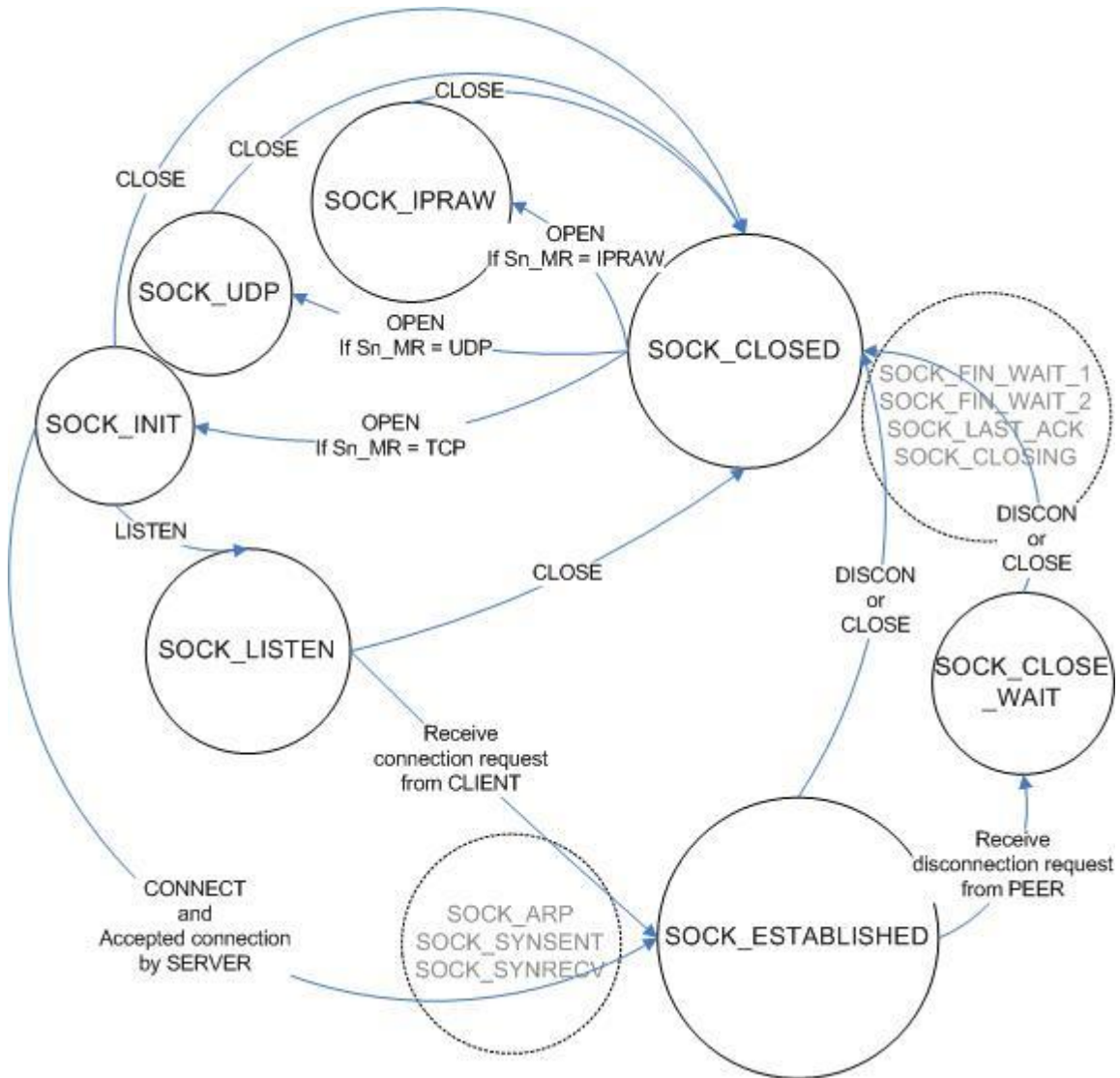

Figure 4-1. State Diagram

Value	Symbol	Description
0x00	SOCK_CLOSED	It is shown in case that CLOSE commands are given to S_n_CR , and Timeout interrupt is asserted or connection is terminated.
0x13	SOCK_INIT	It is shown in case that S_n_MR is set as TCP and OPEN commands are given to S_n_CR .
0x14	SOCK_LISTEN	It is shown in case that LISTEN commands are given to S_n_CR at the SOCK_INIT status
0x17	SOCK_ESTABLISHED	It is shown in case that connection is established.
0x1C	SOCK_CLOSE_WAIT	It is shown in case that connection termination request is received from peer host.
0x22	SOCK_UDP	It is shown in case that OPEN commands are given to S_n_CR when S_n_MR is set as UDP.
0x32	SOCK_IPRAW	It is shown in case that OPEN commands are given to S_n_CR when S_n_MR is set as IPRAW.
0x42	SOCK_MACRAW	It is shown in case that OPEN commands are given to S_0_CR when S_0_MR is set as MACRAW.
0x5F	SOCK_PPPOE	It is shown in case that OPEN commands are given to S_0_CR when S_0_MR is set as PPPoE.

Below is shown during changing the status.

Value	Symbol	Description
0x15	SOCK_SYNSENT	It is shown in case that CONNECT commands are given to Socket n Command Register(S_n_CR) at the SOCK_INIT status. It is automatically changed to SOCK_ESTABLISH when the connection is established.
0x16	SOCK_SYNRECV	It is shown in case that connection request is received from remote peer(CLIENT). It normally responds to the requests and changes to SOCK_ESTABLISH.
0x18	SOCK_FIN_WAIT	It is shown in the process of connection termination. If the termination is normally processed or Timeout interrupt is asserted, it will be automatically changed to SOCK_CLOSED.
0x1A	SOCK_CLOSING	
0x1B	SOCK_TIME_WAIT	
0x1D	SOCK_LAST_ACK	
0x11 0x21 0x31	SOCK_ARP	It is shown when ARP Request is sent in order to acquire Hardware Address of remote peer when it sends connection request in TCP mode or sends data in UDP mode. If ARP Reply is received, it changes to the status, SOCK_SYNSENT, SOCK_UDP or SOCK_ICMP, for the next operation.

Sn_PORT (Socket *n* Source Port Register) [R/W] [0x0404-0x0405, 0x0504-0x0505, 0x0604-0x0605, 0x0704-0x0705] [0x00]

This register sets the Source Port number for each Socket when using TCP or UDP mode, and the set-up needs to be made before executing the OPEN Command.

Ex) In case of Socket 0 Port = 5000(0x1388), configure as below,

0x0404	0x0405
0x13	0x88

Sn_DHAR (Socket *n* Destination Hardware Address Register) [R/W] [0x0406-0x040B, 0x0506-0x050B, 0x0606-0x060B, 0x0706-0x070B] [0xFF]

This register sets the Destination Hardware address of each Socket.

Ex) In case of Socket 0 Destination Hardware address = 08.DC.00.01.02.10, configuration is as below,

0x0406	0x0407	0x0408	0x0409	0x040A	0x040B
0x08	0xDC	0x00	0x01	0x02	0x0A

Sn_DIPR (Socket *n* Destination IP Address Register) [R/W] [0x040C-0x040F, 0x050C-0x050F, 0x060C-0x060F, 0x070C-0x070F] [0x00]

This register sets the Destination IP Address of each Socket to be used in setting the TCP connection. In active mode, IP address needs to be set before executing the Connect command. In passive mode, W3150A+ sets up the connection and then is internally updated with peer IP.

In UDP mode, this register value decided to user's written value after receiving peer's ARP response. Before receiving peer's ARP response, this register has reset value.

Ex) In case of Socket 0 Destination IP address = 192.168.0.11, configure as below.

0x040C	0x040D	0x040E	0x040F
192 (0xC0)	168 (0xA8)	0 (0x00)	11 (0x0B)

Sn_DPORT (Socket *n* Destination Port Register) [R/W] [0x0410-0x0411, 0x0510-0x0511, 0x0610-0x0611, 0x0710-0x0711] [0x00]

This register sets the Destination Port number of each socket to be used in setting the TCP connection. In active mode, port number needs to be set before executing the Connect command. In passive mode, W3150A+ sets up the connection and then is internally updated with peer port number.

In UDP mode, this register value decided to user's written value after receiving peer's ARP response. Before receiving peer's ARP response, this register has reset value.

Ex) In case of Socket 0 Destination Port = 5000(0x1388), configure as below,

0x0410	0x0411
0x13	0x88

Sn_MSS (Socket n Maximum Segment Size Register) [R/W] [0x0412-0x0413, 0x0512-0x0513, 0x0612-0x0613, 0x0712-0x0713] [0x0000]

This register is used for MSS (Maximum Segment Size) of a Packet.

According to communication mode, this register has different values.

- Ex) 1. In normal TCP mode, MSS = 1460(0x05B4)
 2. In PPPoE-TCP mode, MSS = 1452(0x05AC)
 3. In normal UDP mode, MSS = 1472(0x05C0)
 4. In PPPoE-UDP mode, MSS = 1464(0x05B8)

Normal TCP mode configure as below,

0x0412	0x0413
0x05	0xB4

Sn_PROTO (Socket n IP Protocol Register) [R/W] [0x0414, 0x0514, 0x0614, 0x0714] [0x00]

This IP Protocol Register is used to set up the Protocol Field of IP Header at the IP Layer RAW Mode. There are several protocol numbers defined in advance by registering to IANA. For the overall list of upper level protocol identification number that IP is using, refer to online documents of IANA (<http://www.iana.org/assignments/protocol-numbers>).

Ex) Internet Control Message Protocol (ICMP) = 0x01, Internet Group Management Protocol = 0x02

Sn_TOS (Socket n IP Type Of Service Register) [R/W] [0x0415,0x0515,0x0615,0x0715] [0x00]

This register sets up at the TOS Field of IP Header.

Sn_TTL (Socket n IP Time To Live Register) [R/W] [0x0416,0x0516,0x0616,0x0716] [0x80]

This register sets up at the TTL Field of IP Header.

Sn_TX_FSR (Socket n TX Free Size Register) [R] [0x0420-0x0421, 0x0520-0x0521, 0x0620-0x0621, 0x0720-0x0721] [0x0800]

This register notifies the information of data size that user can transmit. For data transmission, user should check this value first and control the size of transmitting data. *When checking this register, user should read upper byte(0x0420,0x0520,0x0620,0x0720) first and lower byte(0x0421,0x0521,0x0621,0x0721) later to get the correct value.*

Ex) In case of 2048(0x0800) in S0_TX_FSR,

0x0420	0x0421
0x08	0x00

Total size can be decided according to the value of TX Memory Size Register. In the process of transmission, it will be reduced by the size of transmitting data, and automatically increased after transmission finished.

Sn_TX_RR (Socket *n* TX Read Pointer Register) [R] [0x0422-0x0423, 0x0522-0x0523, 0x0622-0x0623, 0x0722-0x0723] [0x0000]

This register shows the address that transmission is finished at the TX Memory. With the SEND command of Socket *n* Command Register, it transmits data from current Sn_TX_RR to Sn_TX_WR and automatically changes after transmission is finished. Therefore, after transmission is finished, Sn_TX_RR and Sn_TX_WR will have same value. When reading this register, user should read upper byte (0x0422, 0x0522, 0x0622, 0x0722) first and lower byte (0x0423, 0x0523, 0x0623, 0x0723) later to get the correct value.

Sn_TX_WR (Socket *n* TX Write Pointer Register) [R/W] [0x0424-0x0425, 0x0524-0x0525, 0x0624-0x0625, 0x0724-0x0725] [0x0000]

This register offers the location information to write the transmission data. When reading this register, user should read upper byte (0x0424, 0x0524, 0x0624, 0x0724) first and lower byte (0x0425, 0x0525, 0x0625, 0x0725) later to get the correct value.

Ex) In case of 2048(0x0800) in S0_TX_WR,

0x0424	0x0425
0x08	0x00

But this value itself is not the physical address to write. So, the physical address should be calculated as follow.

1. Socket *n* TX Base Address (hereafter we'll call *gSn_TX_BASE*) and Socket *n* TX Mask Address (hereafter we'll call *gSn_TX_MASK*) are calculated on TMSR value. *Refer to the psedo code of the 5.1 Initialization if the detail is needed.*
2. The bitwise-AND operation of two values, Sn_TX_WR and *gSn_TX_MASK* give result the offset address(hereafter we'll call *get_offset*) in TX memory range of the socket.
3. Two values *get_offset* and *gSn_TX_BASE* are added together to give result the physical address(hereafter, we'll call *get_start_address*).

Now, write the transmission data to *get_start_address* as large as you want. (* There's a case that it exceeds the TX memory upper-bound of the socket while writing. In this case, write the transmission data to the upper-bound, and change the physical address to the *gSn_TX_BASE*. Next, write the rest of the transmission data.)

After that, be sure to increase the Sn_TX_WR value as much as the data size, that indicates the size of writing data. Finally, give SEND command to Sn_CR(Socket *n* Command Register).

Refer to the psedo code of the transmission part on 5.2.1.1. TCP Server mode if the detail is needed.

TMSR = 0x55, Chip Base Address = 0x0000, 512 bytes send

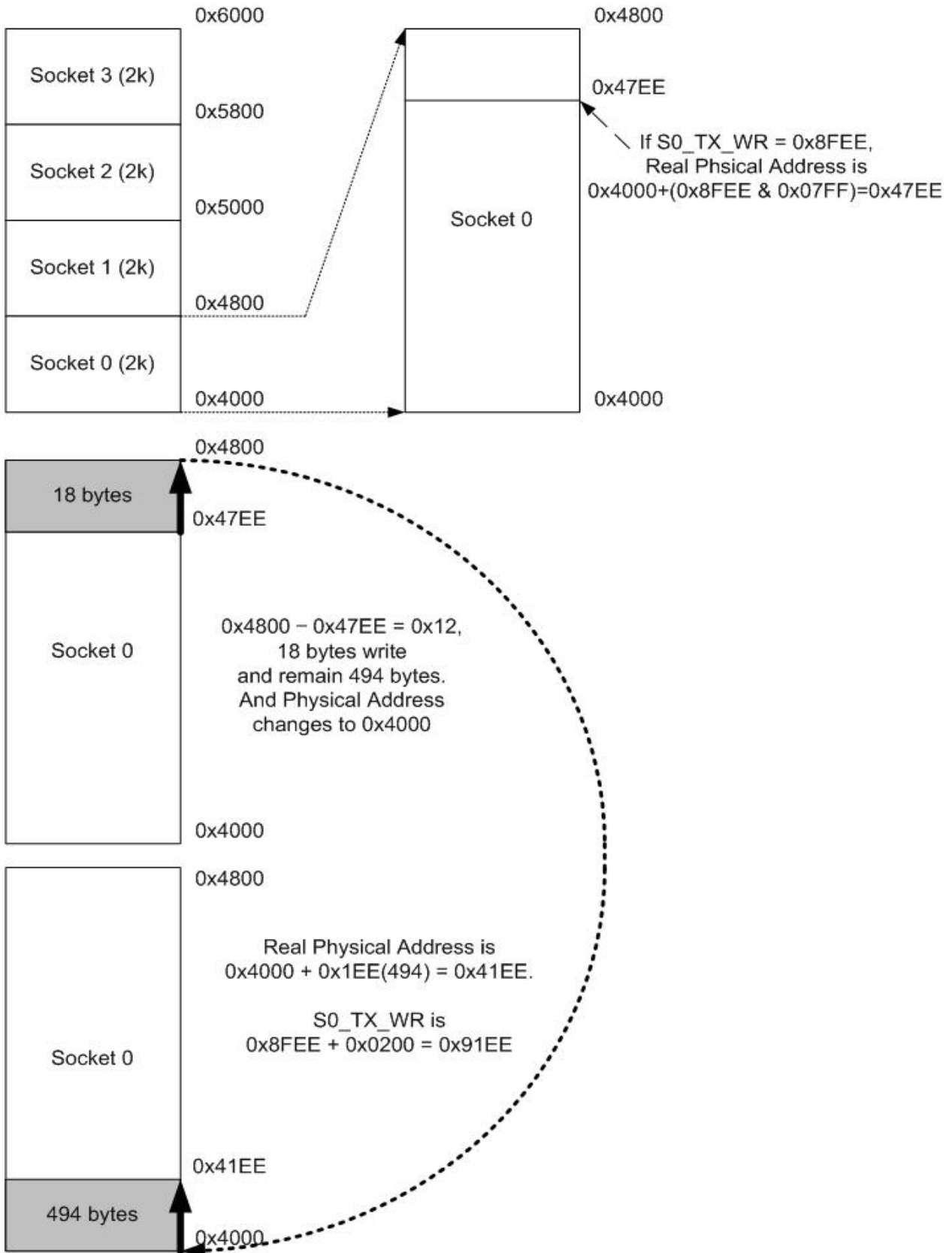

Figure 4-2. Calculate physical address

Sn_RX_RSR (RX Received Size Register) [R] [0x0426-0x0427, 0x0526-0x0527, 0x0626-0x0627, 0x0726-0x0727] [0x0000]

This register notifies the data size received in RX Memory. As this value is internally calculated with the values of Sn_RX_RD and Sn_RX_WR, it is automatically changed by RECV command of Socket *n* Command Register(Sn_CR) and receiving data for remote peer. *When reading this register, user should read upper byte(0x0426,0x0526,0x0626,0x0726) first and lower byte(0x0427,0x0527,0x0627,0x0727) later to get the correct value.*

Ex) In case of 2048(0x0800) in S0_RX_RSR,

0x0426	0x0427
0x08	0x00

The total size of this value can be decided according to the value of RX Memory Size Register.

Sn_RX_RD (Socket *n* RX Read Pointer Register) [R/W] [0x0428-0x0429, 0x0528-0x0529, 0x0628-0x0629, 0x0728-0x0729] [0x0000]

This register offers the location information to read the receiving data. When reading this register, user should read upper byte (0x0428, 0x0528, 0x0628, 0x0728) first and lower byte (0x0429, 0x0529, 0x0629, 0x0729) later to get the correct value.

Ex) In case of 2048(0x0800) in S0_RX_RD,

0x0428	0x0429
0x08	0x00

But this value itself is not the physical address to read. So, the physical address should be calculated as follow.

1. Socket *n* RX Base Address (hereafter we'll call *gSn_RX_BASE*) and Socket *n* RX Mask Address (hereafter we'll call *gSn_RX_MASK*) are calculated on RMSR value. *Refer to the psedo code of the 5.1 Initialization if the detail is needed.*
2. The bitwise-AND operation of two values, Sn_RX_RD and *gSn_RX_MASK* give result the offset address(hereafter we'll call *get_offset*), in RX memory range of the socket.
3. Two values *get_offset* and *gSn_RX_BASE* are added together to give result the physical address(hereafter, we'll call *get_start_address*).

Now, read the receiving data from *get_start_address* as large as you want. (* There's a case that it exceeds the RX memory upper-bound of the socket while reading. In this case, read the receiving data to the upper-bound, and change the physical address to the *gSn_RX_BASE*. Next, read the rest of the receiving data.)

After that, be sure to increase the Sn_RX_RD value as large as the data size, that indicates the size of reading data. (* Must not increase more than the size of received data. So must check Sn_RX_RSR before receiving process.) Finally, give RECV command to Sn_CR(Socket *n* Command Register).

Refer to the psedo code of the receiving part on 5.2.1.1. TCP Server mode if the detail is needed.

5. Functional Description

By setting some register and memory operation, W3150A+ provides internet connectivity. This chapter describes how it can be operated.

5.1. Initialization

- Setting network information

Below register is for basic network configuration information to be configured according to the network environment.

1. Gateway Address Register (GAR)
2. Source Hardware Address Register (SHAR)
3. Subnet Mask Register (SUBR)
4. Source IP Address Register (SIPR)

The Source Hardware Address Register (SHAR) is the H/W address to be used in MAC layer, and can be used with the address that manufacturer has been assigned. The MAC address can be assigned from IEEE. For more detail, refer to IEEE homepage.

- Set socket memory information

This stage sets the socket tx/rx memory information. The base address and mask address of each socket are fixed and saved in this stage.

In case of, assign 2K rx memory per socket.

```

{
    RMSR = 0x55; // assign 2K rx memory per socket.
    gS0_RX_BASE = chip_base_address + RX_memory_base_address(0x6000);
    gS0_RX_MASK = 2K - 1 ; // 0x07FF, for getting offset address within assigned socket 0 RX memory.
    gS1_RX_BASE = gS0_BASE + (gS0_MASK + 1);
    gS1_RX_MASK = 2K - 1 ;
    gS2_RX_BASE = gS1_BASE + (gS1_MASK + 1);
    gS2_RX_MASK = 2K - 1 ;
    gS3_RX_BASE = gS2_BASE + (gS2_MASK + 1);
    gS3_RX_MASK = 2K - 1 ;
    TMSR = 0x55; // assign 2K tx memory per socket.
    Same method, set gS0_TX_BASE, gS0_TX_MASK, gS1_TX_BASE, gS1_TX_MASK, gS2_TX_BASE,
    gS2_TX_MASK, gS3_TX_BASE and gS3_TX_MASK.
}
    
```

In case of, assign 4K,2K,1K,1K.

```

{
    RMSR = 0x06; // assign 4K,2K,1K,1K rx memory per socket.
    gS0_RX_BASE = chip_base_address + RX_memory_base_address(0x6000);
    gS0_RX_MASK = 4K - 1 ; // 0x0FFF, for getting offset address within assigned socket 0 RX memory.
    gS1_RX_BASE = gS0_BASE + (gS0_MASK + 1);
    gS1_RX_MASK = 2K - 1 ; // 0x07FF
    gS2_RX_BASE = gS1_BASE + (gS1_MASK + 1);
    gS2_RX_MASK = 1K - 1 ; // 0x03FF
    gS3_RX_BASE = gS2_BASE + (gS2_MASK + 1);
    gS3_RX_MASK = 1K - 1 ; // 0x03FF
    TMSR = 0x06; // assign 4K,2K,1K,1K rx memory per socket.
    Same method, set gS0_TX_BASE, gS0_TX_MASK, gS1_TX_BASE, gS1_TX_MASK, gS2_TX_BASE,
    gS2_TX_MASK, gS3_TX_BASE and gS3_TX_MASK.
}
    
```

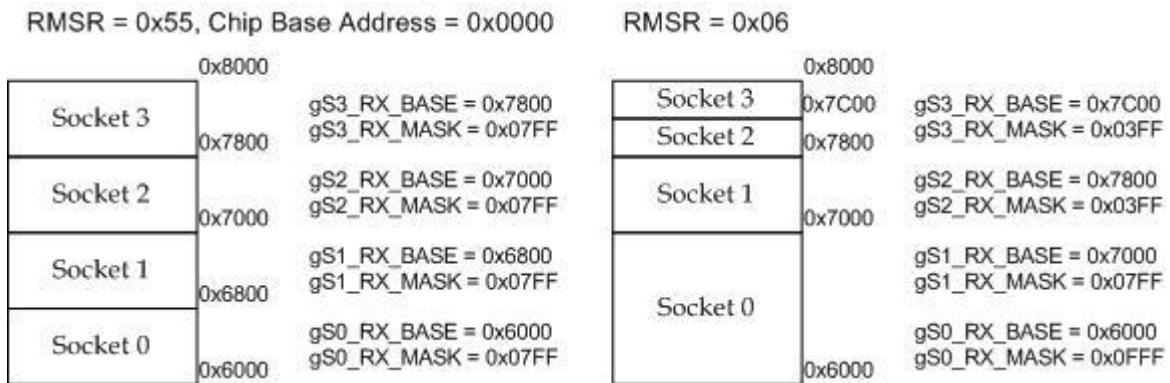

Figure 5-1. In case of RMSR = 0x55

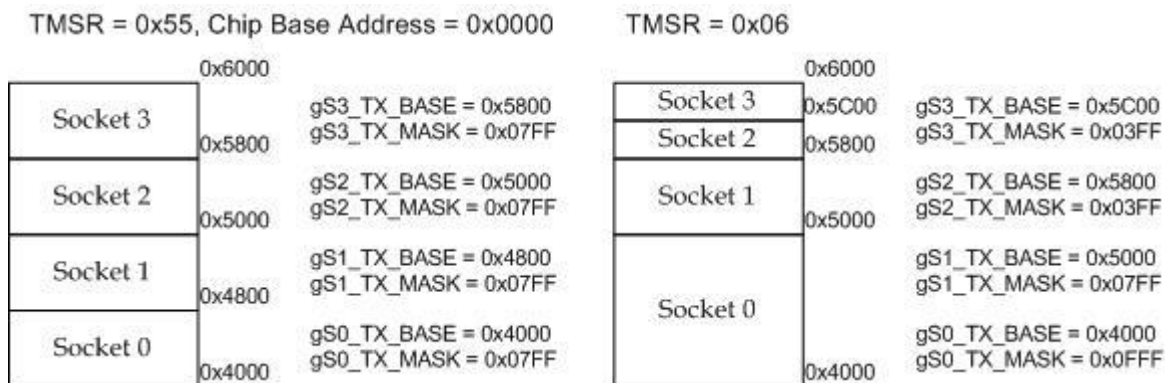

Figure 5-2. In case of TMSR = 0x55

5.2. Data communication

Data communication is available through TCP ,UDP ,IP-Raw and MAC-Raw . In order to select it, configure protocol field of Socket *n* Mode Register(*Sn_MR*) of the communcation sockets (W3150A+ supports total 4 sockets).

5.2.1. TCP

TCP is connection oriented communication method that will establish connection in advance and deliver the data through the connection by using IP Address and Port number of the systems. There are two methods to establish the connection. One is SERVER mode(passive open) that is waiting for connection request. The other is CLIENT mode(active open) that sends connection request to SERVER.

5.2.1.1. SERVER mode

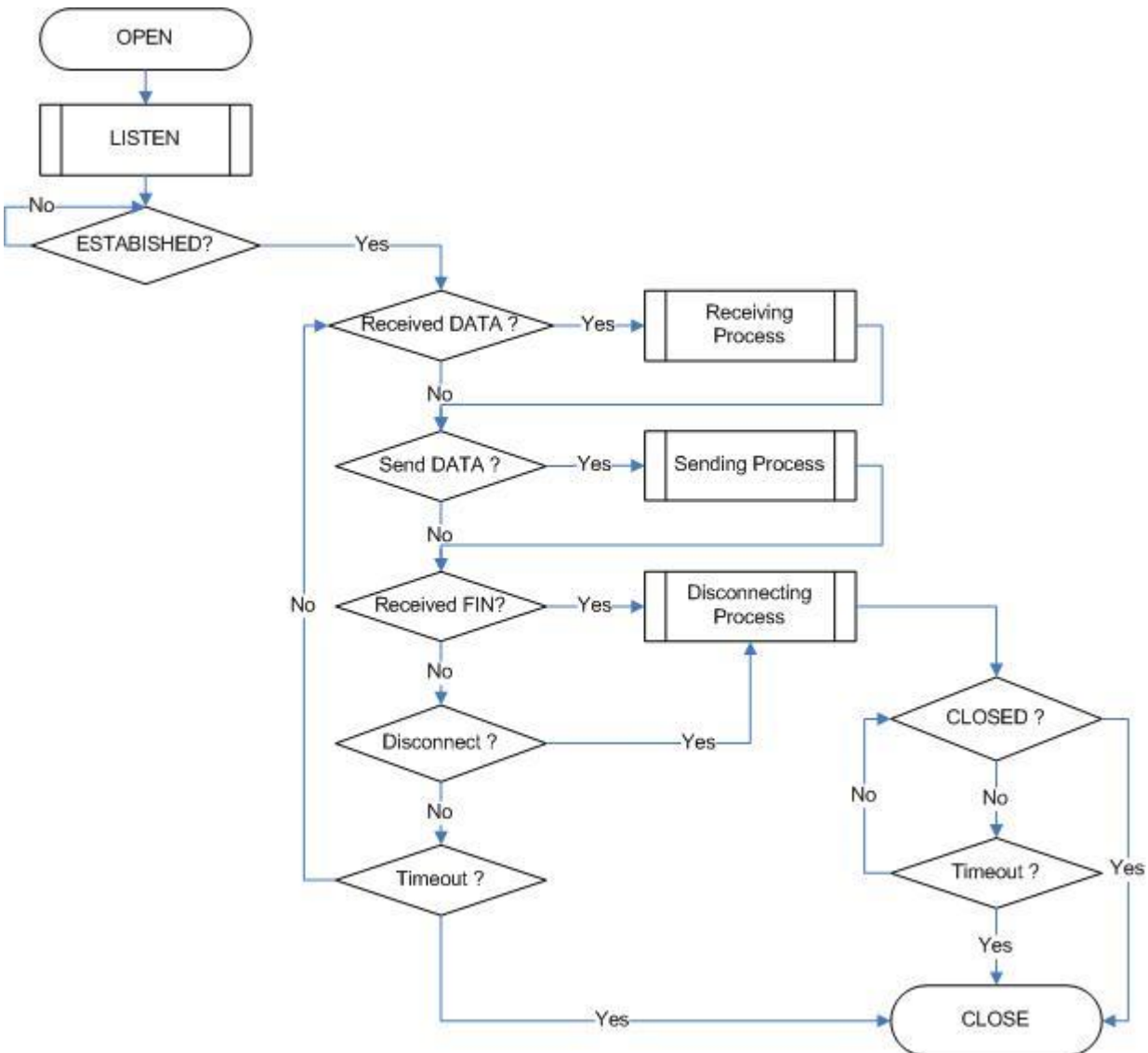

■ Socket Initialization

It initializes the socket *n* as TCP,

```

{
START:
    /* sets TCP mode */
    Sn_MR = 0x01;
    /* sets source port number */
    Sn_PORT = source_port;
    /* sets OPEN command */
    Sn_CR = OPEN;
    if (Sn_SR != SOCK_INIT) Sn_CR = CLOSE; goto START;
}
    
```

■ LISTEN

In order to wait for a connection request **from peer host**.

```

{
    /* listen socket */
    Sn_CR = LISTEN;
    if (Sn_SR != SOCK_LISTEN) Sn_CR = CLOSE; goto START; // check socket status
}
    
```

■ ESTABLISHED ?

If received connection request from remote peer (the status of SOCK_SYNRCV), W3150A+ sends ACK packet and changes to SOCK_ESTABLISHED status. This status can be checked as below.

First method :

```

{
    If (Sn_IR(CON bit) == '1') goto ESTABLISHED stage;
    /* In this case, if the interrupt of Socket n is activated, interrupt occurs. Refer to Interrupt Register(IR), Interrupt Mask Register (IMR) and Socket n Interrupt Register (Sn_IR). */
}
    
```

Second method :

```

{
    If (Sn_SR == SOCK_ESTABLISHED) goto ESTABLISHED stage;
}
    
```

As connection is established, data transmission and receipt can be performed.

■ ESTABLISHED : Received Data ?

Check as below to know if data is received from remote peer or not.

```

First method :
{
    if (Sn_RX_RSR != 0x0000) goto Receiving Process stage;
}

Second Method :
{
    If (Sn_IR(RECV bit) == '1') goto Receiving Process stage;
    /* In this case, if the interrupt of Socket n is activated, interrupt occurs. Refer to Interrupt
       Register(IR), Interrupt Mask Register (IMR) and Socket n Interrupt Register (Sn_IR). */
}
    
```

■ ESTABLISHED : Receiving Process

Received data can be processed as below.

```

{
    /* first, get the received size */
    get_size = Sn_RX_RSR;
    /* calculate offset address */
    get_offset = Sn_RX_RD & gSn_RX_MASK;
    /* calculate start address(physical address) */
    get_start_address = gSn_RX_BASE + get_offset;

    /* if overflow socket RX memory */
    if ( (get_offset + get_size) > (gSn_RX_MASK + 1) )
    {
        /* copy upper_size bytes of get_start_address to destination_addr */
        upper_size = (gSn_RX_MASK + 1) - get_offset;
        memcpy(get_start_address, destination_addr, upper_size);
        /* update destination_addr*/
        destination_addr += upper_size;
        /* copy left_size bytes of gSn_RX_BASE to destination_addr */
        left_size = get_size - upper_size;
        memcpy(gSn_RX_BASE, destination_addr, left_size);
    }
    else
    
```



```

{
    /* copy get_size bytes of get_start_address to destination_addr */
    memcpy(get_start_address, destination_addr, get_size);
}
/* increase Sn_RX_RD as length of get_size */
Sn_RX_RD += get_size;
/* set RECV command */
Sn_CR = RECV;
}

```

■ ESTABLISHED : Send DATA ? / Sending Process

The sending procedure is as below.

```

{
    /* first, get the free TX memory size */
FREESIZE:
    get_free_size = Sn_TX_FSR;
    if (get_free_size < send_size) goto FREESIZE;

    /* calculate offset address */
    get_offset = Sn_TX_WR & gSn_TX_MASK;
    /* calculate start address(physical address) */
    get_start_address = gSn_TX_BASE + get_offset;

    /* if overflow socket TX memory */
    if ( (get_offset + send_size) > (gSn_TX_MASK + 1) )
    {
        /* copy upper_size bytes of source_addr to get_start_address */
        upper_size = (gSn_TX_MASK + 1) - get_offset;
        memcpy(source_addr, get_start_address, upper_size);
        /* update source_addr */
        source_addr += upper_size;
        /* copy left_size bytes of source_addr to gSn_TX_BASE */
        left_size = send_size - upper_size;
        memcpy(source_addr, gSn_TX_BASE, left_size);
    }
    else
    {

```

```

        /* copy send_size bytes of source_addr to get_start_address */
        memcpy(source_addr, get_start_address, send_size);
    }
    /* increase Sn_TX_WR as length of send_size */
    Sn_TX_WR += send_size;
    /* set SEND command */
    Sn_CR = SEND;
}
    
```

■ ESTABLISHED : Received FIN?

Waiting for a connection termination request from remote peer.

It can be checked as below if it received connection termination request of remote peer.

First method :

```

{
    If (Sn_IR(DISCON bit) == '1') goto CLOSED stage;
    /* In this case, if the interrupt of Socket n is activated, interrupt occurs. Refer to Interrupt
       Register(IR), Interrupt Mask Register (IMR) and Socket n Interrupt Register (Sn_IR). */
}
    
```

Second method :

```

{
    If (Sn_SR == SOCK_CLOSE_WAIT) goto CLOSED stage;
}
    
```

■ ESTABLISHED : Disconnect ? / Disconnecting Process

Check if user requests to terminate this connection.

To terminate the connection, proceed as below,

```

{
    /* set DISCON command */
    Sn_CR = DISCON;
}
    
```

■ ESTABLISHED : CLOSED ?

No connection state at all. It can be checked as below,

First method :

```

{
    If (Sn_IR(DISCON bit) == '1') goto CLOSED stage;
    /* In this case, if the interrupt of Socket n is activated, interrupt occurs. Refer to Interrupt
       Register(IR), Interrupt Mask Register (IMR) and Socket n Interrupt Register (Sn_IR). */
}
    
```

```

        Register(IR), Interrupt Mask Register (IMR) and Socket n Interrupt Register (Sn_IR). */
    }
    Second method :
    {
        If (Sn_SR == SOCK_CLOSED) goto CLOSED stage;
    }
    
```

■ ESTABLISHED : Timeout

In case that connection is closed due to the error of remote peer during data receiving or connection closing process, data transmission can not be normally processed. At this time Timeout occurs after some time.

```

    First method :
    {
        If (Sn_IR(TIMEOUT bit) == '1') goto CLOSED stage;
        /* In this case, if the interrupt of Socket n is activated, interrupt occurs. Refer to Interrupt
           Register(IR), Interrupt Mask Register (IMR) and Socket n Interrupt Register (Sn_IR). */
    }
    Second method :
    {
        If (Sn_SR == SOCK_CLOSED) goto CLOSED stage;
    }
    
```

■ Socket Close

This process should be processed in case that connection is closed after data exchange, socket should be closed with Timeout occurrence, or forcible disconnection is necessary due to abnormal operation.

```

    {
        /* set CLOSE command */
        Sn_CR = CLOSE;
    }
    
```

5.2.1.2. CLIENT mode

Whole process is shown as below.

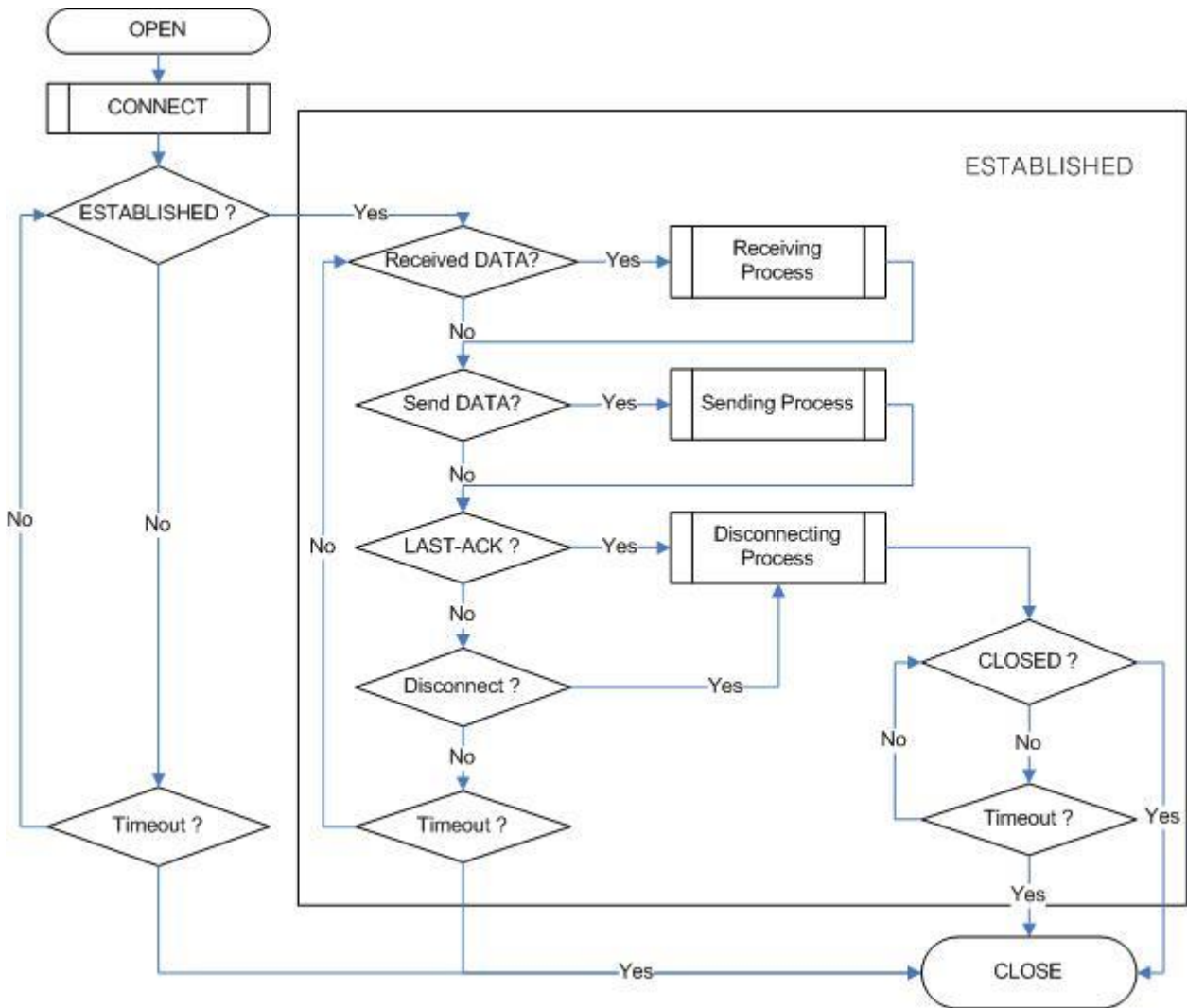

- Socket Initialization

Refer to 5.2.1.1 SERVER (The operation is same as SERVER).

- CONNECT

Send connection request to remote HOST(SERVER) is as below.

```

{
    /* Write the value of server_ip, server_port to the Socket n Destination IP Address Register(Sn_DIPR),
    Socket n Destination Port Register(Sn_DPORT). */
    Sn_DIPR = server_ip;
    Sn_DPORT = server_port;
    /* set CONNECT command */
    Sn_CR = CONNECT;
}
    
```

■ ESTABLISHED ?

The connection is established. It can be checked as below,

First method :

```
{  
  If (Sn_IR(CON bit) == '1') goto ESTABLISHED stage;  
  /* In this case, if the interrupt of Socket n is activated, interrupt occurs. Refer to Interrupt  
     Register(IR), Interrupt Mask Register (IMR) and Socket n Interrupt Register (Sn_IR). */  
}
```

Second method :

```
{  
  If (Sn_SR == SOCK_ESTABLISHED) goto ESTABLISHED stage;  
}
```

■ Timeout

Socket is closed as Timeout occurs as there is not response from remote peer. It can be checked as below.

First method :

```
{  
  If (Sn_IR(TIMEOUT bit) == '1') goto CLOSED stage;  
  /* In this case, if the interrupt of Socket n is activated, interrupt occurs. Refer to Interrupt  
     Register(IR), Interrupt Mask Register (IMR) and Socket n Interrupt Register (Sn_IR). */  
}
```

Second method :

```
{  
  If (Sn_SR == SOCK_CLOSED) goto CLOSED stage;  
}
```

■ ESTABLISHED

Refer to 5.2.1.1. SERVER (The operation is same as SERVER mode)

5.2.2. UDP

UDP provides unreliable and connectionless datagram transmission structure. It processes data without connection establishment. Therefore, UDP message can be lost, overlapped or reversed. As packets can arrive faster, recipient can not process all of them. In this case, user application should guarantee the reliability of data transmission. UDP transmission can be processed as below,

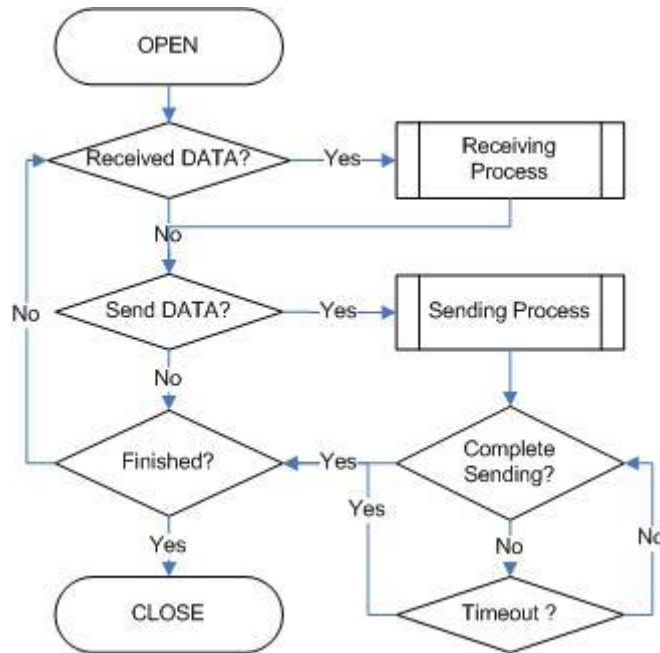

■ Socket Initialization

Initialize the socket *n* as UDP.

```

{
START:
  /* sets UDP mode */
  Sn_MR = 0x02;
  /* sets source port number */
  /* ※ The value of Source Port can be appropriately delivered when remote HOST knows it. */
  Sn_PORT = source_port;
  /* sets OPEN command */
  Sn_CR = OPEN;
  /* Check if the value of Socket n Status Register(Sn_SR) is SOCK_UDP. */
  if (Sn_SR != SOCK_UDP) Sn_CR = CLOSE; goto START;
}
  
```

■ Received DATA?

It can be checked as below if data is received from remote peer.

First method :

```
{
    if (Sn_RX_RSR != 0x0000) goto Receiving Process stage;
}
```

Second Method :

```
{
    If (Sn_IR(RECV bit) == '1') goto Receiving Process stage;
    /* In this case, if the interrupt of Socket n is activated, interrupt occurs. Refer to Interrupt
       Register(IR), Interrupt Mask Register (IMR) and Socket n Interrupt Register (Sn_IR). */
}
```

■ Receiving Process

Received data can be processed as below. In case of UDP, 8byte header is attached to receiving data. The structure of the header is as below.

Destination IP Address (4)	Destination Port (2)	Data size (2) (*data size except for 8byte of header)
----------------------------	----------------------	---

```
{
    /* first, get the received size */
    get_size = Sn_RX_RSR;
    /* calculate offset address */
    get_offset = Sn_RX_RD & gSn_RX_MASK;
    /* calculate start address(physical address) */
    get_start_address = gSn_RX_BASE + get_offset;

    /* read head information (8 bytes) */
    header_size = 8;
    /* if overflow socket RX memory */
    if ( (get_offset + header_size) > (gSn_RX_MASK + 1) )
    {
        /* copy upper_size bytes of get_start_address to header_addr */
        upper_size = (gSn_RX_MASK + 1) - get_offset;
        memcpy(get_start_address, header_addr, upper_size);
        /* update header_addr */
        header_addr += upper_size;
        /* copy left_size bytes of gSn_RX_BASE to header_addr */
    }
}
```

```

left_size = header_size - upper_size;
memcpy(gSn_RX_BASE, header_addr, left_size);
/* update get_offset */
get_offset = left_size;
}
else
{
/* copy header_size bytes of get_start_address to header_addr */
memcpy(get_start_address, header_addr, header_size);
/* update get_offset */
get_offset += header_size;
}
/* update get_start_address */
get_start_address = gSn_RX_BASE + get_offset;

/* save remote peer information & received data size */
peer_ip = header[0 to 3];
peer_port = header[4 to 5];
get_size = header[6 to 7];

/* if overflow socket RX memory */
if ( ( get_offset + get_size ) > ( gSn_RX_MASK + 1 ) )
{
/* copy upper_size bytes of get_start_address to destination_addr */
upper_size = ( gSn_RX_MASK + 1 ) - get_offset;
memcpy(get_start_address, destination_addr, upper_size);
/* update destination_addr*/
destination_addr += upper_size;
/* copy left_size bytes of gSn_RX_BASE to destination_addr */
left_size = get_size - upper_size;
memcpy(gSn_RX_BASE, destination_addr, left_size);
}
else
{
/* copy get_size bytes of get_start_address to destination_addr */
memcpy(get_start_address, destination_addr, get_size);
}

```



```

    /* increase Sn_RX_RD as length of get_size+header_size */
    Sn_RX_RD = Sn_RX_RD + get_size + header_size;
    /* set RECV command */
    Sn_CR = RECV;
}
    
```

■ Send Data? / Sending Process

Data transmission process is as below.

```

{
    /* first, get the free TX memory size */
    FREESIZE:
    get_free_size = Sn_TX_FSR;
    if (get_free_size < send_size) goto FREESIZE;

    /* Write the value of remote_ip, remote_port to the Socket n Destination IP Address Register(Sn_DIPR),
       Socket n Destination Port Register(Sn_DPORT). */
    Sn_DIPR = remote_ip;
    Sn_DPORT = remote_port;

    /* calculate offset address */
    get_offset = Sn_TX_WR & gSn_TX_MASK;
    /* calculate start address(physical address) */
    get_start_address = gSn_TX_BASE + get_offset;

    /* if overflow socket TX memory */
    if ( (get_offset + send_size) > (gSn_TX_MASK + 1) )
    {
        /* copy upper_size bytes of source_addr to get_start_address */
        upper_size = (gSn_TX_MASK + 1) - get_offset;
        memcpy(source_addr, get_start_address, upper_size);
        /* update source_addr*/
        source_addr += upper_size;
        /* copy left_size bytes of source_addr to gSn_TX_BASE */
        left_size = send_size - upper_size;
        memcpy(source_addr, gSn_TX_BASE, left_size);
    }
    else
    
```

```

{
    /* copy send_size bytes of source_addr to get_start_address */
    memcpy(source_addr, get_start_address, send_size);
}
/* increase Sn_TX_WR as length of send_size */
Sn_TX_WR += send_size;
/* set SEND command */
Sn_CR = SEND;
}

```

■ Complete Sending?

The sending completion should be checked after SEND command.

```

{
    If (Sn_CR == 0x00) transmission is completed.
}

```

■ Timeout

Timeout occurs if remote peer does not exist or data transmission is not normally processed. It can be checked as below.

```

{
    If (Sn_IR(TIMEOUT bit) == '1') goto next stage;
    /* In this case, if the interrupt of Socket n is activated, interrupt occurs. Refer to Interrupt Register(IR), Interrupt Mask Register (IMR) and Socket n Interrupt Register (Sn_IR). */
}

```

■ Finished? / Socket Close

If all the actions are finished, close the socket.

```

{
    /* set CLOSE command */
    Sn_CR = CLOSE;
}

```

5.2.3. IP raw

IP Raw mode can be utilized if transport layer protocol of some ICMP or IGMP that W3150A+ does not support, needs to be processed.

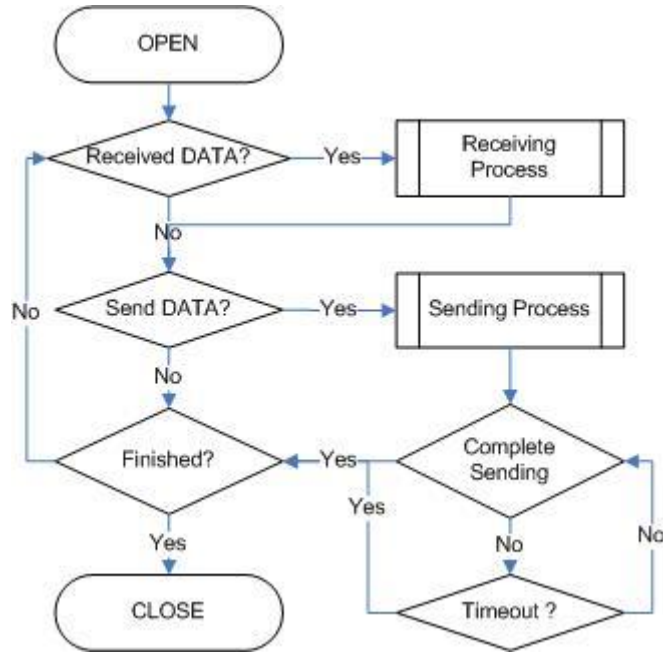

■ Socket Initialization

It initializes the socket as IP raw.

```

{
START:
  /* sets IP raw mode */
  Sn_MR = 0x03;
  /* sets Protocol value */
  /* The value of Protocol is the value used in Protocol Field of IP Header.
  For the list of protocol identification number of upper classification, refer to on line documents of
  IANA (http://www.iana.org/assignments/protocol-numbers). */
  Sn_PROTO = protocol_value;
  /* sets OPEN command */
  Sn_CR = OPEN;
  /* Check if the value of Socket n Status Register(Sn_SR) is SOCK_IPRAW. */
  if (Sn_SR != SOCK_IPRAW) Sn_CR = CLOSE; goto START;
}
  
```

- Received DATA?

It is same as UDP. Refer to 5.2.2 UDP.

- Receiving Process

This is same as UDP. Refer to 5.2.2 UDP except the header information and header size.

In case of IP raw, 6byte header is attached to the data received. The header structure is as below.

Destination IP Address (4)	Data Size (2) (*Data size except for 6 bytes of header)
----------------------------	---

- Send DATA? / Sending Process

This is same as UDP. Refer to 5.2.2 UDP except that remote_port information is not needed.

- Complete Sending

- Timeout

- Finished? / Socket Closed

Next actions are same as UDP. Refer to 5.2.2 UDP.

5.2.4. MAC raw

MAC Raw mode(only supported in socket 0) can be utilized.

- Socket Initialization

It initializes the socket as MAC raw.

```
{
START:
  /* sets MAC raw mode */
  Sn_MR = 0x04;
  /* sets OPEN command */
  Sn_CR = OPEN;
  /* Check if the value of Socket n Status Register(Sn_SR) is SOCK_MACRAW. */
  if (Sn_SR != SOCK_MACRAW) Sn_CR = CLOSE; goto START;
}
```

- Received DATA?

This is same as UDP. Refer to 5.2.2 UDP.

- Receiving Process

MAC raw received Ethernet packet having packet size information.

In case of MAC raw, 2byte header is attached to the data received. The header structure is as below.

Data Size (2) (*Data size include 2 bytes of header)
--

- Send DATA? / Sending Process

This is same as UDP. Refer to 5.2.2 UDP except that remote_port information is not needed.

6. Application Information

For the communication with MCU, W3150A+ provides Direct and Indirect Bus I/F, and SPI I/F modes. For the communication with Ethernet PHY, MII is used.

6.1. Direct Bus I/F Mode.

Direct Bus I/F mode uses 15bit address line and 8bit data line, /CS, /RD, /WR, /INT.

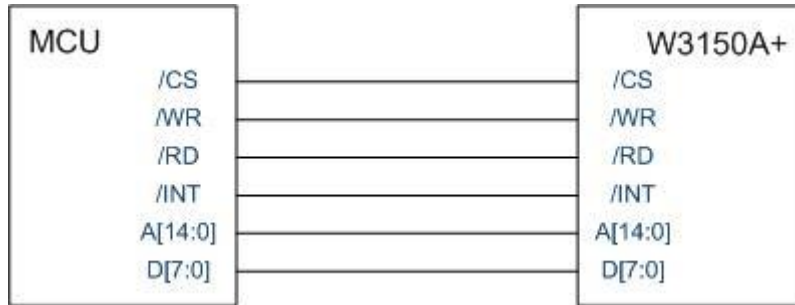

6.2. Indirect Bus I/F Mode.

Indirect Bus I/F mode uses 2bit address line and 8bit data line, /CS, /RD, /WR, /INT. [14:2], other address lines should process Pull-down.

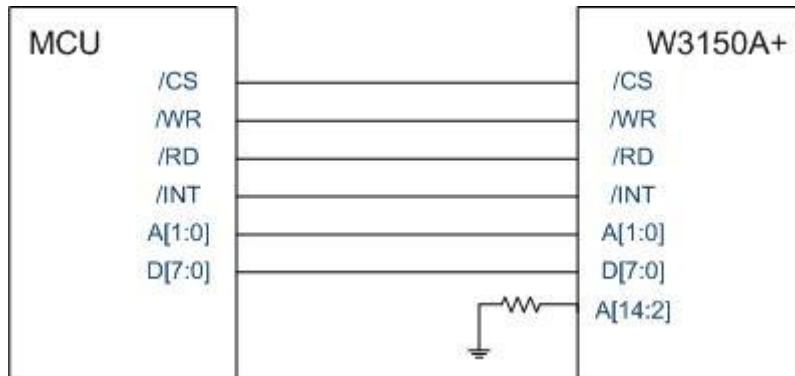

Indirect bus I/F mode related register is as below.

Value	Symbol	Description
0x00	MR	It performs the selection of Indirect bus I/F mode, address automatic increase. Refer to 4. Register Description for more detail.
0x01 0x02	IDM_AR0 IDM_AR1	Indirect bus I/F mode address Register W3150A+ used in Big-endian ordering only. . In case of Big-endian ordering <div style="display: flex; justify-content: space-around; align-items: center;"> 0x01 0x02 </div> <div style="border: 1px solid black; padding: 2px; display: flex; justify-content: space-between; width: 100%;"> IDM_AR0 : MSB IDM_AR1 : LSB </div> Ex) In case of reading S0_CR(0x0401), <div style="display: flex; justify-content: space-around; align-items: center;"> 0x01(IDM_AR0) 0x02(IDM_AR1) </div> <div style="border: 1px solid black; padding: 2px; display: flex; justify-content: space-around; width: 100%;"> 0x04 0x01 </div>
0x03	IDM_DR	Indirect bus I/F mode data Register

In order to read or write the internal register or internal TX/RX Memory,

1. Write the address to read or write on IDM_AR0,1.
2. Read or Write IDM_DR.

In order to read or write the data on the sequential address, set AI bit of MR(Mode Register). With this, user performs above 1 only one time. Whenever read or write IDM_DR, IDM_AR value is automatically increased by 1. So, the value can be processed on the sequential address just by continuous reading or writing of IDM_DR.

6.3. Serial Peripheral Interface (SPI) Mode

Serial Peripheral Interface Mode uses only four pins for data communication.

Four pins are SCLK, /SS, MOSI, MISO.

W3150A+ uses one more pin for Enabling SPI Operation. This pin is SPI_EN pin.

By asserting SPI_EN pin high, A[14~11] pins turn to SCLK, /SS, MOSI, MISO pins.

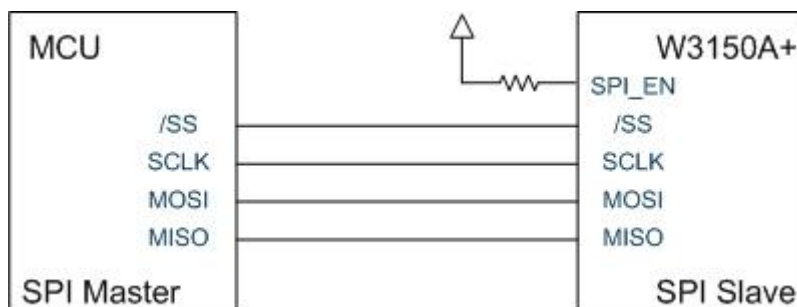

Figure 6-1. Connection between MCU and W3150A+

▪ 6.3.1 Device Operation

The W3150A+ is controlled by a set of instruction that is sent from a host controller, commonly referred to as the SPI Master. The SPI Master communicates with W3150A+ via the SPI bus which is composed of four signal lines: Slave Select(/SS), Serial Clock(SCLK), MOSI(Master Out Slave In), MISO(Master In Slave Out).

The SPI protocol defines four modes for its operation (Mode 0, 1, 2, 3). Each mode differs according to the SCLK polarity and phase - how the polarity and phase control the flow of data on the SPI bus.

The W3150A+ is SPI Slave device and supports the most common modes - SPI Mode 0 and 3.

The only difference between SPI Mode 0 and 3 is the polarity of the SCLK signal at the inactive state. With SPI Mode 0 and 3, data is always latched in on the rising edge of SCLK and always output on the falling edge of SCLK.

▪ 6.3.2 Commands

According to SPI protocol, there are only two data lines between SPI devices. So, it is necessary to define OP-Code. W3150A+ uses two kinds of OP-Code, Read OP-Code and Write OP-Code. Except for those two OP-Codes, W3150A+ will be ignored and no operation will be started.

In SPI Mode, W3150A+ operates in “unit of 32-bit stream”.

The unit of 32-bit stream is composed of 1 byte OP-Code Field, 2 bytes Address Field and 1 byte data Field. OP-Code, Address and data bytes are transferred with the most significant bit(MSB) first and least significant bit(LSB) last. In other words, The first bit of SPI data is MSB of OP-Code Field and the last bit of SPI data is LSB of Data-Field. W3150A+ SPI data format is as below.

Command	OP-Code Field		Address Field	Data Field
Write operation	0xF0	1111 0000	2 bytes	1 byte
Read operation	0x0F	0000 1111	2 bytes	1 byte

▪ 6.3.3 Process of using general SPI Master device (According to SPI protocol)

- 1. Configure Input/Output direction on SPI Master device pins.
 - * /SS (Slave Select) : Output pin
 - * SCLK (Serial Clock) : Output pin
 - * MOSI (Master Out Slave In) : Output pin
 - * MISO (Master In Slave Out) : Input pin
- 2. Configure /SS as ‘High’
- 3. Configure the registers on SPI Master device.
 - * SPI Enable bit on SPCR register (SPI Control Register)
 - * Master/Slave select bit on SPCR register
 - * SPI Mode bit on SPCR register
 - * SPI data rate bit on SPCR register and SPSR register (SPI State Register)

- 4. Write desired value for transmission on SPDR register (SPI Data Register).
- 5. Configure /SS as 'Low' (data transfer start)
- 6. Wait for reception complete
- 7. If all data transmission ends, configure /SS as 'High'

SPI write/read operation timing is as below.

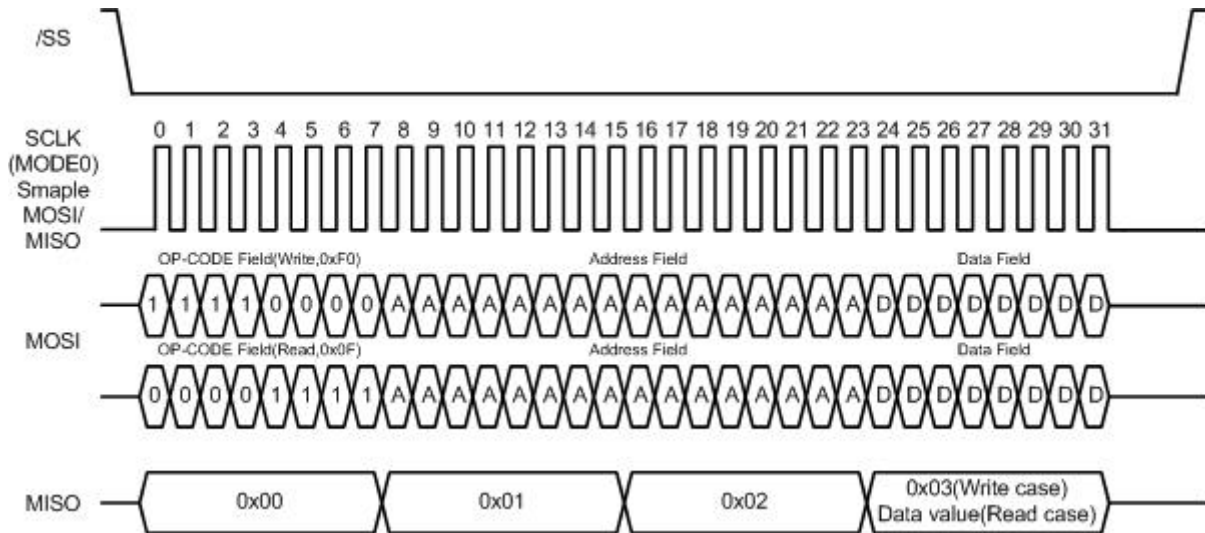

6.4. MII (Media Independent Interface)

The MII handles the data transfer between the W3150A+ and the Physical Layer Device.

The MII is composed of TX_CLK, TXE, and TXD[0:3] signals for sending data and RX_CLK, CRS, RXDV, RXD[0:3], and COL signals for receiving data.

When sending data from the W3150A+, TXE and TXD[0:3] are output in synchronization with the falling edges of TX_CLK input from the Physical Layer Device because Physical Layer Devices generally recognize the rising edges of TX_CLK.

When receiving data, in general, the Physical Layer Devices output CRS, RXDV, RXD[0:3], and COL signals in synchronization with the falling edges of RX_CLK, so the W3150A+ recognizes the signals at the rising edges of RX_CLK.

7. Electrical Specification

7.1. Absolute Maximum Ratings

Symbol	Parameter	Rating	Unit
V _{DD}	DC Supply voltage	-0.5 to 3.6	V
V _{IN}	DC input voltage	-0.5 to 5.5 (5V tolerant)	V
I _{IN}	DC input current	±5	mA
T _{OP}	Operating temperature	-40 to 80 (* refer to qualification report in our website)	°C
T _{STG}	Storage temperature	-55 to 125	°C

*COMMENT: Stressing the device beyond the “Absolute Maximum Ratings” may cause permanent damage.

7.2. DC Characteristics

Symbol	Parameter	Test Condition	Min	Typ	Max	Unit
V _{DD}	DC Supply voltage	Junction temperature is from -55°C to 125°C	3.0		3.6	V
V _{IH}	High level input voltage		2.0		5.5	V
V _{IL}	Low level input voltage		- 0.5		0.8	V
V _{OH}	High level output voltage	I _{OH} = 2, 4, 8, 12, 16, 24 mA	2.0		3.6	V
V _{OL}	Low level output voltage	I _{OL} = -2, -4, -8, -12, -16, -24 mA	0.0		0.4	V
I _I	Input Current	V _{IN} = V _{DD}			±5	μA

7.3. POWER DISSIPATION

Symbol	Parameter	Test Condition	Min	Typ	Max	Unit
P _{10Base}	Power consumption in 10BaseT			16		mA
P _{100Base}	Power consumption in 100BaseT			24		mA

7.4. AC Characteristics

7.4.1. Reset Timing

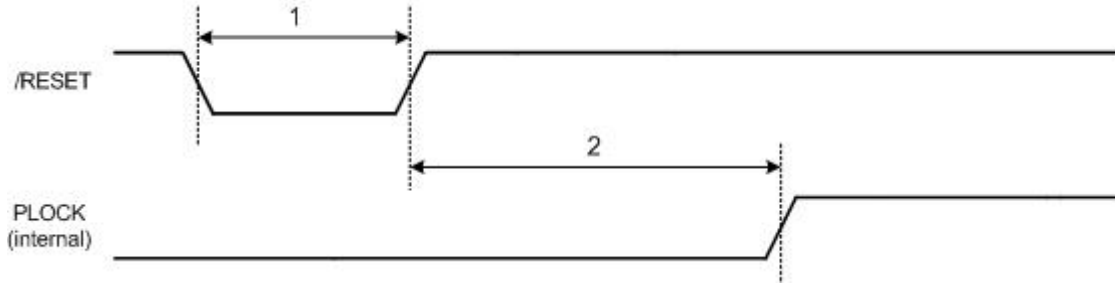

Description	Min	Max
1. Reset Cycle Time	2 us	-
2. /RESET to internal PLOCK	-	10 ms

7.4.2. Register/Memory READ Timing

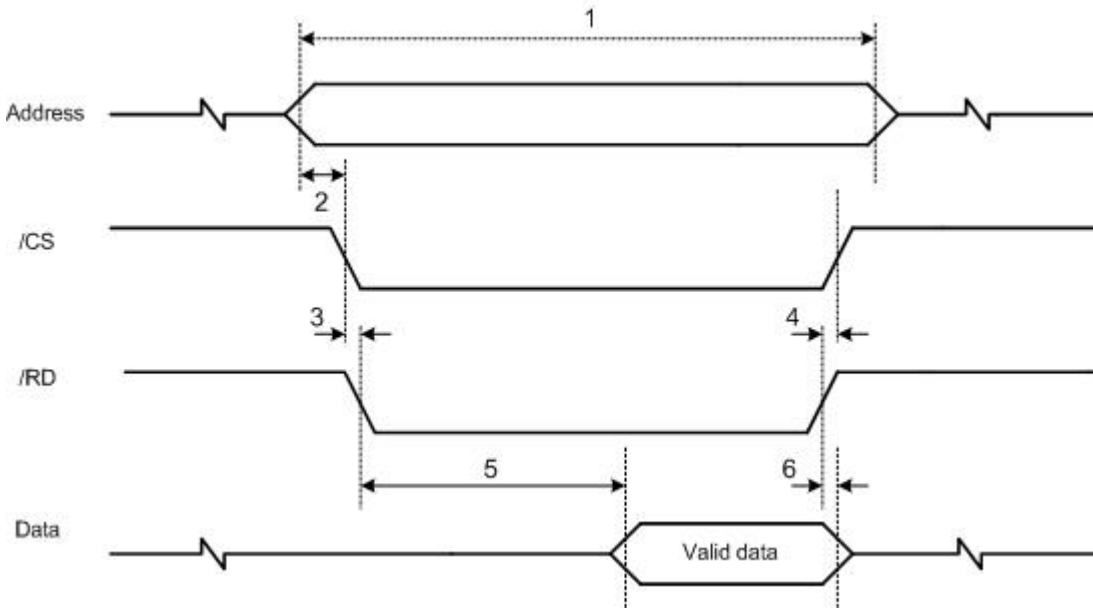

Description	Min	Max
1. Read Cycle Time	80 ns	-
2. Valid Address to /CS low time	8 ns	-
3. /CS low to /RD low time	-	1 ns
4. /RD high to /CS high time	-	1 ns
5. /RD low to Valid Data Output time	-	80 ns
6. /RD high to Data High-Z Output time	-	1 ns

7.4.3. Register/Memory WRITE Timing

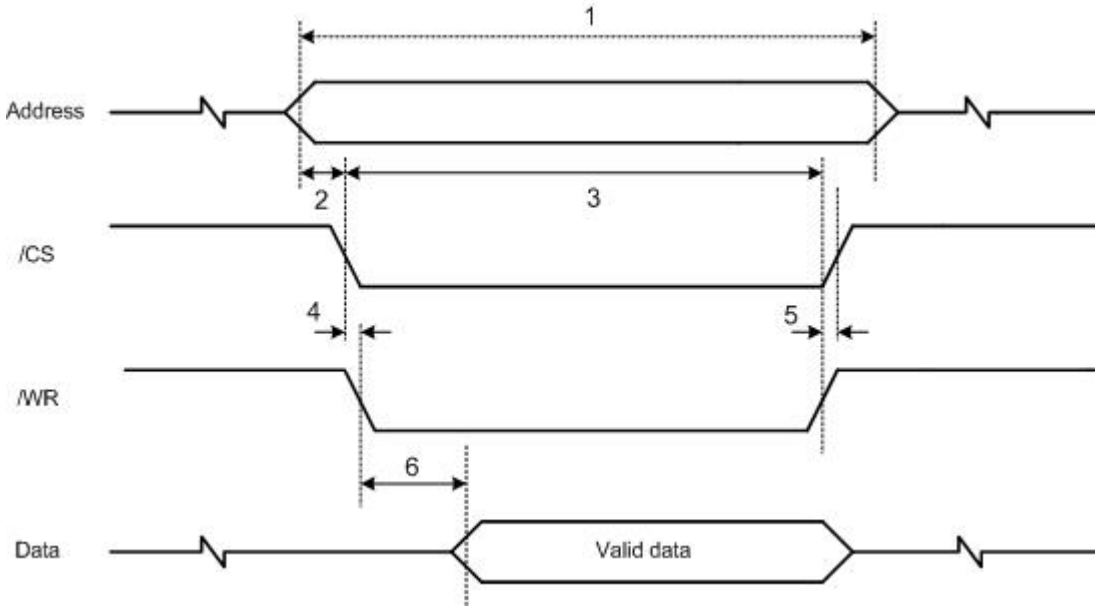

Description	Min	Max
1. Write Cycle Time	70 ns	-
2. Valid Address to /CS low time	7 ns	-
3. /CS low to /WR high time	70 ns	
4. /CS low to /WR low time	-	1 ns
5. /WR high to /CS high time	-	1 ns
6. /WR low to Valid Data time	-	14 ns

7.4.4. SPI Timing

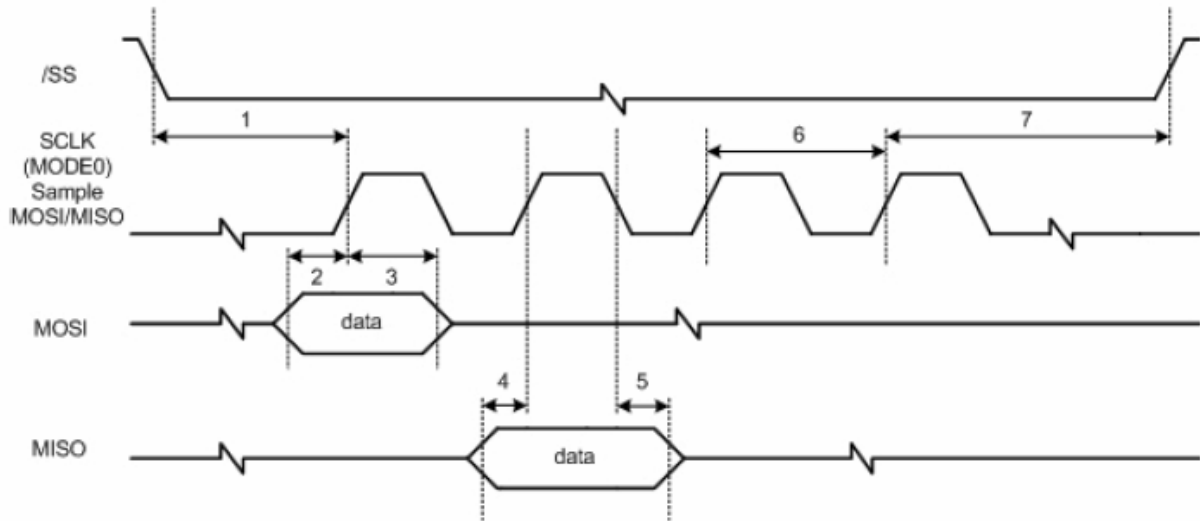

Description	Mode	Min	Max
1 /SS low to SCLK	Slave	21 ns	-
2 Input setup time	Slave	7 ns	-
3 Input hold time	Slave	28 ns	-
4 Output setup time	Slave	7 ns	14 ns
5 Output hold time	Slave	21 ns	-
6 SCLK time	Slave	70 ns	-
7 SCLK high to /SS high	Slave	21ns	-

7.4.5. MII(Media Independent Interface) Timing

■ MII Tx TIMING

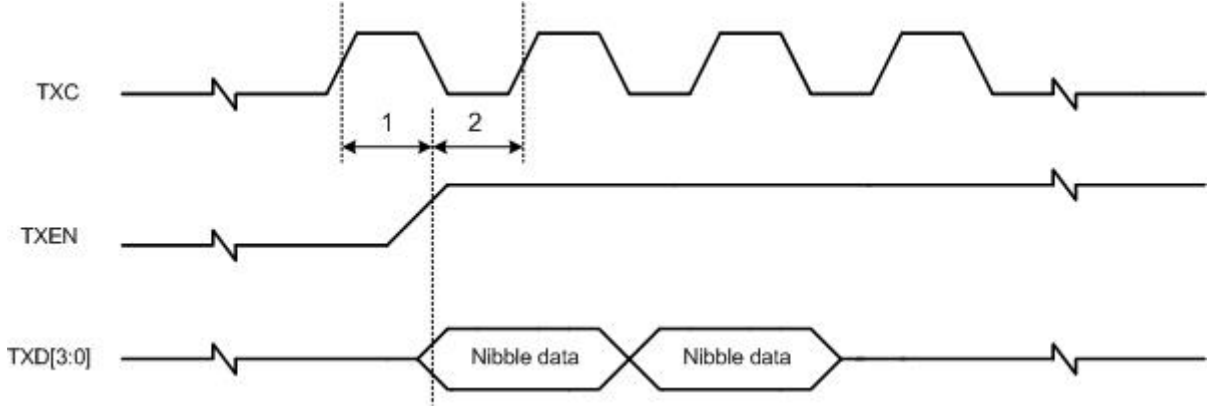

Description	Notes	Min	Typ	Max
1. TX_CLK to TXD, TX_EN	10 Mbps	202 ns	-	205 ns
2. TXD, TX_EN setup time to TX_CLK	10 Mbps	195 ns	-	198 ns
1. TX_CLK to TXD, TX_EN	100 Mbps	22 ns	-	25 ns
2. TXD, TX_EN setup time to TX_CLK	100 Mbps	15 ns	-	18 ns

■ MII Rx TIMING

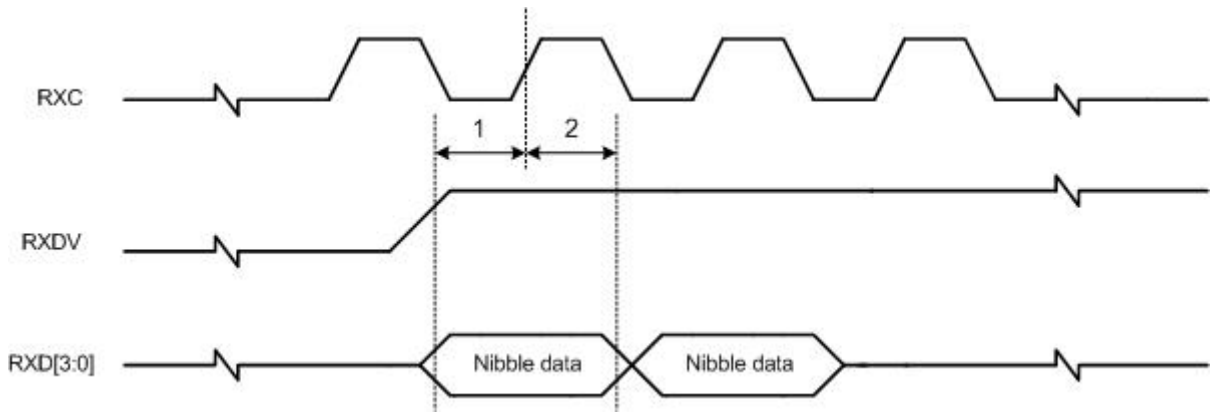

Description	Notes	Min	Typ	Max
1. Valid Data to RX_CLK time (setup time)	10 Mbps	5 ns	-	-
2. RX_CLK to Valid Data time (hold time)	10 Mbps	5 ns	-	-
1. Valid Data to RX_CLK time (setup time)	100 Mbps	5 ns	-	-
2. RX_CLK to Valid Data time (hold time)	100 Mbps	5 ns	-	-

8. IR Reflow Temperature Profile (Lead-Free)

- Moisture Sensitivity Level at 260°C IR Condition: 2.
- Dry Bag Required: Yes
- 1 year out of bag time at max 30°C /60%RH.

Max. Temperature 260°C	
Ramp up rate	< 3°C /second
Pre-heat temperature at 175°C(±25°C)	77-95 seconds
Temperature above 217°C	96-107 seconds
Time within 5°C of actual peak temperature	17-25 seconds
Peak temperature range	258-260°C
Ramp-down rate	< 6°C /second

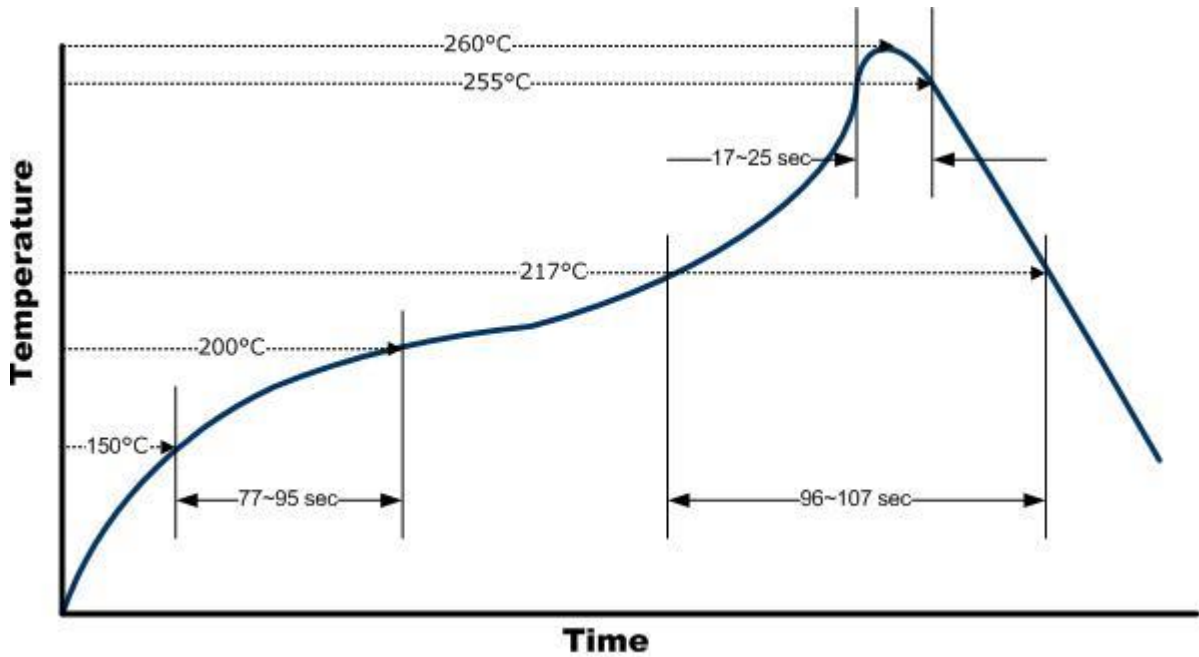

9. Package Description

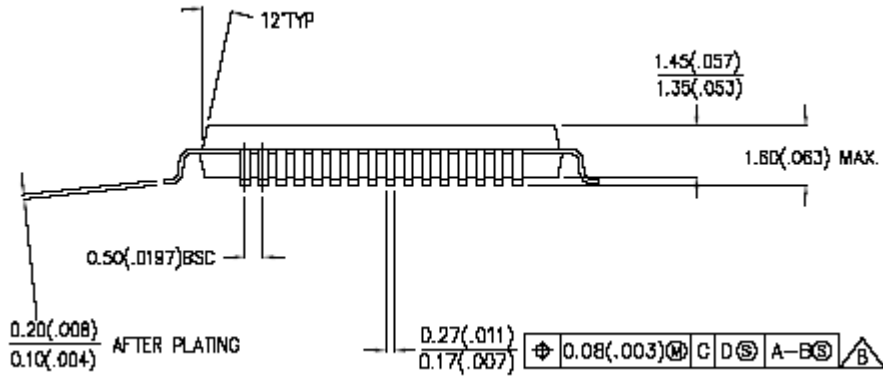
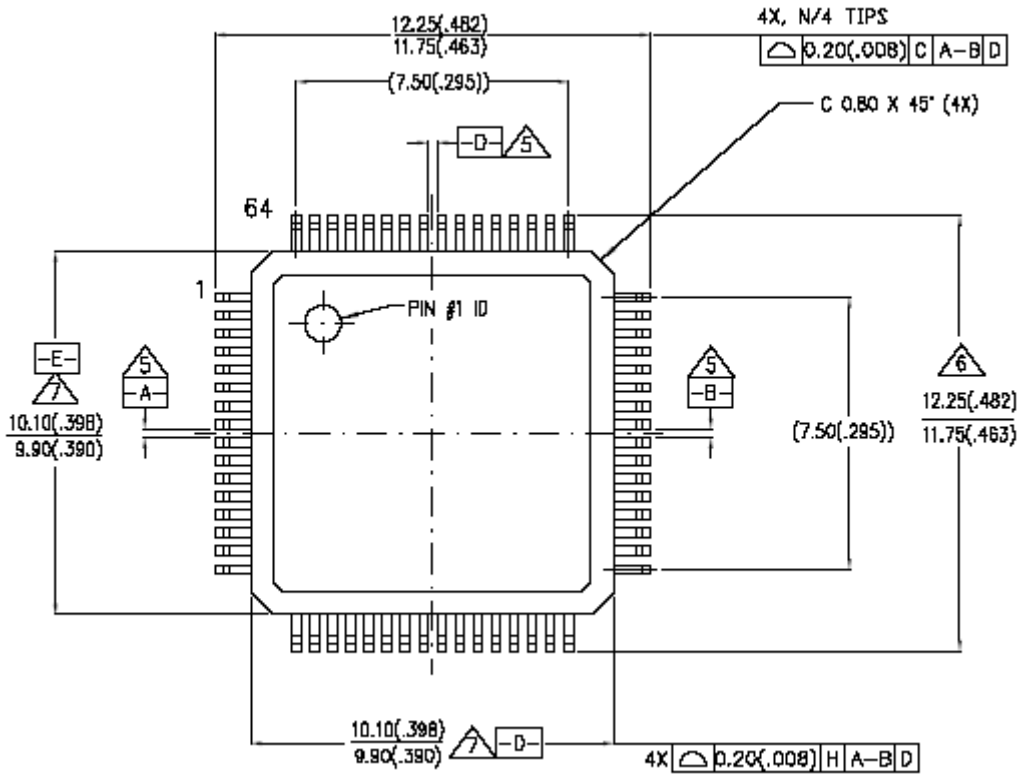

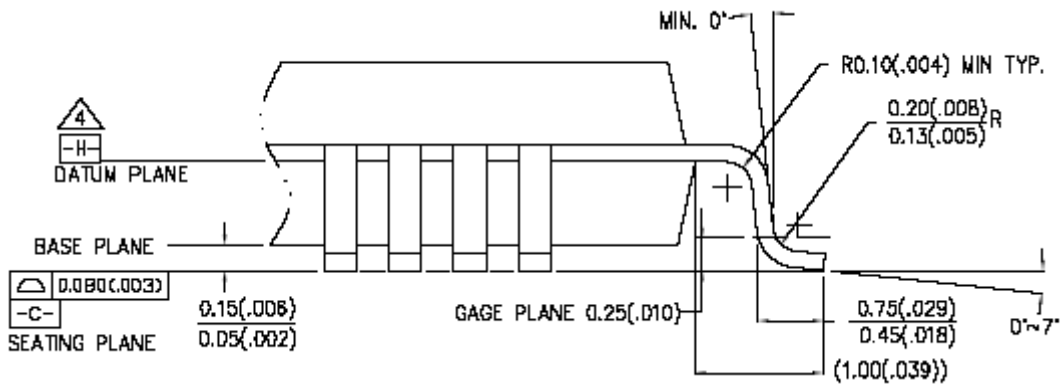

NOTES :

1. PACKAGE DIMENSIONS CONFORM TO JEDEC REGISTRATION MO - 136 - BCD.
2. CONTROLLING DIMENSIONS : MILLIMETERS. INCH ARE SHOWN IN PARENTHESES.
3. DIMENSIONS AND TOLERANCING PER ANSI Y 14.5-1982.
4. DATUM PLANE "H" IS LOCATED AT MOLD PARTING LINE AND IS COINCIDENT WITH THE LEAD EXITS THE PLASTIC BODY AT BOTTOM OF THE PARTING LINE.
5. DATUMS "A-B" AND "D" TO BE DETERMINED AT DATUM PLANE "H".
6. TO BE DETERMINED AT THE SEATING PLANE "C"
7. THESE DIMENSIONS TO BE DETERMINED AT DATUM PLANE "H". DIMENSIONS D AND E DO NOT INCLUDE MOLD PROTRUSION. ALLOWABLE PROTRUSION IS 0.25MM(.010") PER SIDE.
8. LEAD WIDTH DOES NOT INCLUDE DAMBAR PROTRUSION. ALLOWABLE DAMBAR PROTRUSION SHALL BE 0.08 MM/0.003" TOTAL IN EXCESS OF THIS DIMENSIONS AT MAXIMUM MATERIAL CONDITION.

Компания «Океан Электроники» предлагает заключение долгосрочных отношений при поставках импортных электронных компонентов на взаимовыгодных условиях!

Наши преимущества:

- Поставка оригинальных импортных электронных компонентов напрямую с производств Америки, Европы и Азии, а так же с крупнейших складов мира;
- Широкая линейка поставок активных и пассивных импортных электронных компонентов (более 30 млн. наименований);
- Поставка сложных, дефицитных, либо снятых с производства позиций;
- Оперативные сроки поставки под заказ (от 5 рабочих дней);
- Экспресс доставка в любую точку России;
- Помощь Конструкторского Отдела и консультации квалифицированных инженеров;
- Техническая поддержка проекта, помощь в подборе аналогов, поставка прототипов;
- Поставка электронных компонентов под контролем ВП;
- Система менеджмента качества сертифицирована по Международному стандарту ISO 9001;
- При необходимости вся продукция военного и аэрокосмического назначения проходит испытания и сертификацию в лаборатории (по согласованию с заказчиком);
- Поставка специализированных компонентов военного и аэрокосмического уровня качества (Xilinx, Altera, Analog Devices, Intersil, Interpoint, Microsemi, Actel, Aeroflex, Peregrine, VPT, Syfer, Eurofarad, Texas Instruments, MS Kennedy, Miteq, Cobham, E2V, MA-COM, Hittite, Mini-Circuits, General Dynamics и др.);

Компания «Океан Электроники» является официальным дистрибьютором и эксклюзивным представителем в России одного из крупнейших производителей разъемов военного и аэрокосмического назначения «JONHON», а так же официальным дистрибьютором и эксклюзивным представителем в России производителя высокотехнологичных и надежных решений для передачи СВЧ сигналов «FORSTAR».



JONHON

«JONHON» (основан в 1970 г.)

Разъемы специального, военного и аэрокосмического назначения:

(Применяются в военной, авиационной, аэрокосмической, морской, железнодорожной, горно- и нефтедобывающей отраслях промышленности)

«FORSTAR» (основан в 1998 г.)

ВЧ соединители, коаксиальные кабели, кабельные сборки и микроволновые компоненты:

(Применяются в телекоммуникациях гражданского и специального назначения, в средствах связи, РЛС, а так же военной, авиационной и аэрокосмической отраслях промышленности).



Телефон: 8 (812) 309-75-97 (многоканальный)

Факс: 8 (812) 320-03-32

Электронная почта: ocean@oceanchips.ru

Web: <http://oceanchips.ru/>

Адрес: 198099, г. Санкт-Петербург, ул. Калинина, д. 2, корп. 4, лит. А