

## Aluminum Capacitors SMD (Chip), High Temperature

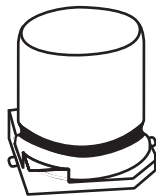
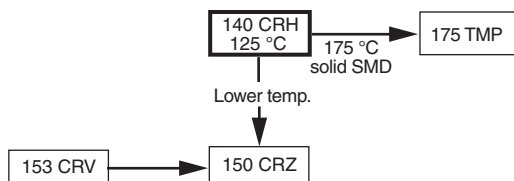

Fig.1 Component outline



### FEATURES

- Polarized aluminum electrolytic capacitors, non-solid electrolyte, self healing
- SMD-version with base plate, lead (Pb)-free reflow solderable
- High temperature, 3000 h at 125 °C
- High capacitance values
- Very long useful life: 5000 h at 105 °C for case size  $\geq 12.5 \times 12.5 \times 13$
- Standard 4 pin-version for diameter  $\geq 12.5$  mm
- 4 pin-version for diameter 10 mm on request
- Charge and discharge proof, no peak current limitation
- Lead (Pb)-free and RoHS compliant
- ATTENTION: for maximum safe soldering conditions refer to Fig. 4



**RoHS**  
COMPLIANT

### APPLICATIONS

- SMD technology, for high mounting density
- Industrial and professional applications
- Automotive, general industrial
- Smoothing, filtering, buffering
- 4 pin-version for high vibration

### MARKING

- Rated capacitance (in  $\mu\text{F}$ )
- Rated voltage (in V)
- Date code, in accordance with IEC 60062
- Black mark or ‘-’ sign indicating the cathode (the anode is identified by bevelled edges)
- Code indicating group number (H)

### PACKAGING

Supplied in blister tape on reel

QUICK REFERENCE DATA	
DESCRIPTION	VALUE
Nominal case sizes (L x W x H in mm)	8 x 8 x 10 to 12.5 x 12.5 x 16
Rated capacitance range, $C_R$	10 to 1000 $\mu\text{F}$
Tolerance on $C_R$	$\pm 20\%$
Rated voltage range, $U_R$	6.3 to 63 V
Category temperature range	- 55 to + 125 °C
Endurance test at 125 °C: case size $\leq 10 \times 10 \times 14$ case size $\geq 12.5 \times 12.5 \times 13$	1000 hours 2000 hours
Useful life at 125 °C: case size $\leq 10 \times 10 \times 14$ case size $\geq 12.5 \times 12.5 \times 13$	1500 hours 3000 hours
Useful life at 40 °C; 1.8 x $I_R$ applied: case size $\leq 10 \times 10 \times 14$ case size $\geq 12.5 \times 12.5 \times 13$	150 000 hours 300 000 hours
Shelf life at 0 V, 125 °C	1000 hours
Based on sectional specification	IEC 60384-18/CECC32300
Climatic category IEC 60068	55/125/56

SELECTION CHART FOR $C_R$ , $U_R$ AND RELEVANT NOMINAL CASE SIZES (L x W x H in mm)							
$C_R$ ( $\mu\text{F}$ )	$U_R$ (V)						
	6.3	10	16	25	35	50	63
10	-	-	-	-	-	-	8 x 8 x 10
22	-	-	-	-	-	-	8 x 8 x 10
33	-	-	-	-	-	-	8 x 8 x 10
47	-	-	-	-	-	8 x 8 x 10	10 x 10 x 10
68	-	-	-	-	8 x 8 x 10	10 x 10 x 10	10 x 10 x 14
100	-	-	-	8 x 8 x 10	10 x 10 x 10	10 x 10 x 14	12.5 x 12.5 x 13
150	-	-	8 x 8 x 10	-	10 x 10 x 14	-	12.5 x 12.5 x 16
220	-	8 x 8 x 10	-	10 x 10 x 10	12.5 x 12.5 x 13	12.5 x 12.5 x 13	-
330	8 x 8 x 10	10 x 10 x 10	10 x 10 x 14	12.5 x 12.5 x 13	12.5 x 12.5 x 13	12.5 x 12.5 x 16	-
470	10 x 10 x 10	10 x 10 x 14	12.5 x 12.5 x 13	12.5 x 12.5 x 16	12.5 x 12.5 x 16	-	-
680	10 x 10 x 14	12.5 x 12.5 x 13	12.5 x 12.5 x 16	-	-	-	-
1000	-	12.5 x 12.5 x 16	-	-	-	-	-

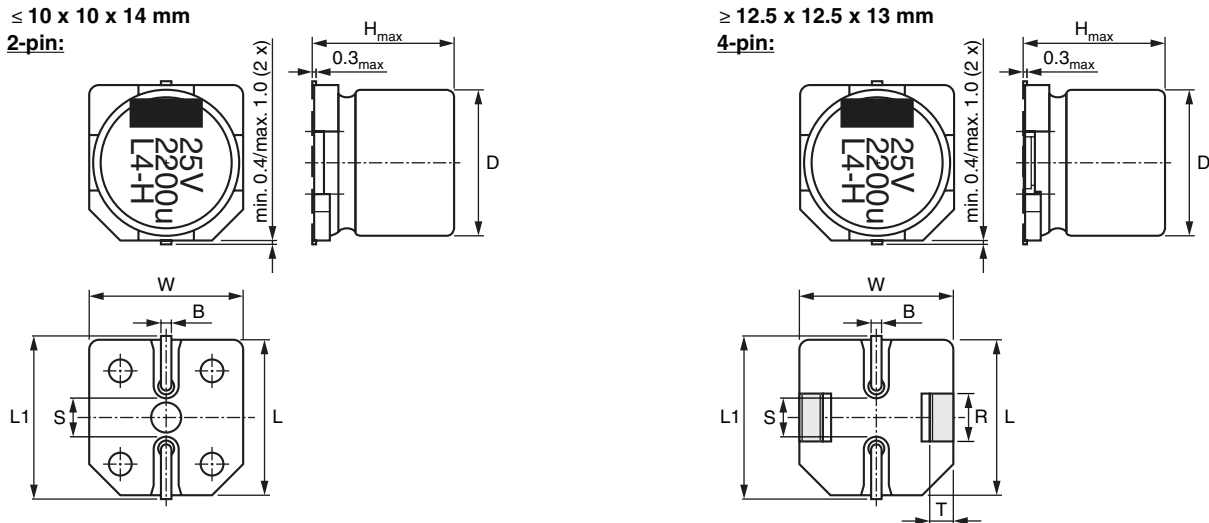

Fig.2 Dimensional outline

Table 1

DIMENSIONS in millimeters AND MASS											
NOMINAL CASE SIZE L x W x H	CASE CODE	L <sub>max.</sub>	W <sub>max.</sub>	H <sub>max.</sub>	Ø D	B <sub>max.</sub>	S	L1 <sub>max.</sub>	R ± 0.1	T ± 0.1	MASS (g)
8 x 8 x 10	0810	8.5	8.5	10.5	8.0	1.0	2.2	9.9	-	-	≈ 1.0
10 x 10 x 10	1010	10.5	10.5	10.5	10.0	1.0	3.5	11.8	-	-	≈ 1.3
10 x 10 x 14	1014	10.5	10.5	14.3	10.0	1.0	3.5	11.8	-	-	≈ 1.5
12.5 x 12.5 x 13	1213	12.8	12.8	14.0	12.5	1.3	3.6	14.9	3.7	2.4	≈ 2.6
12.5 x 12.5 x 16	1216	12.8	12.8	16.5	12.5	1.3	3.6	14.9	3.7	2.4	≈ 2.8

Table 2

TAPE AND REEL DIMENSIONS in millimeters, PACKAGING QUANTITIES						
NOMINAL CASE SIZE L x W x H	CASE CODE	PITCH P <sub>1</sub>	TAPE WIDTH W	TAPE THICKNESS T <sub>2</sub>	REEL DIAMETER	PACKAGING QUANTITY PER REEL
8 x 8 x 10	0810	16	24	11.3	380	500
10 x 10 x 10	1010	16	24	11.3	380	500
10 x 10 x 14	1014	16	24	14.8	330	250
12.5 x 12.5 x 13	1213	20	24	15.5	380	250
12.5 x 12.5 x 16	1216	24	32	17.5	380	200

**Note**

Detailed tape dimensions see section 'PACKAGING'.

**MOUNTING**

The capacitors are designed for automatic placement on to printed-circuit boards.

Optimum dimensions of soldering pads depend amongst others on soldering method, mounting accuracy, print layout and/or adjacent components.

For recommended soldering pad dimensions, refer to Fig.3 and Table 3.

**SOLDERING**

Soldering conditions are defined by the curve, temperature versus time, where the temperature is that measured on the component during processing.

For maximum conditions refer to Fig.4.

Any temperature versus time curve which does not exceed the specified maximum curves may be applied.

 AS A GENERAL PRINCIPLE, TEMPERATURE AND DURATION SHALL BE THE **MINIMUM** NECESSARY REQUIRED TO ENSURE GOOD SOLDERING CONNECTIONS. HOWEVER, THE SPECIFIED MAXIMUM CURVES SHOULD NEVER BE EXCEEDED.

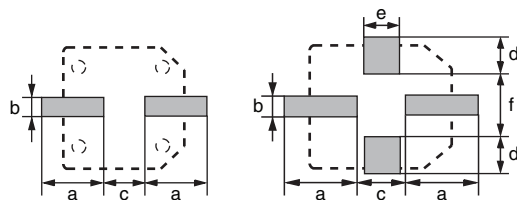

Case size  $\varnothing D \leq 10$  mm      Case size  $\varnothing D \geq 12.5$  mm  
Fig.3 Recommended soldering pad dimensions

Table 3

RECOMMENDED SOLDERING PAD DIMENSIONS in millimeters						
CASE CODE	a	b	c	d	e	f
0810	3.5	2.5	3.0	-	-	-
1010	4.3	2.5	4.0	-	-	-
1014	4.3	2.5	4.0	-	-	-
1213	5.5	2.5	4.0	4.2	5.0	5.6
1216	5.5	2.5	4.0	4.2	5.0	5.6

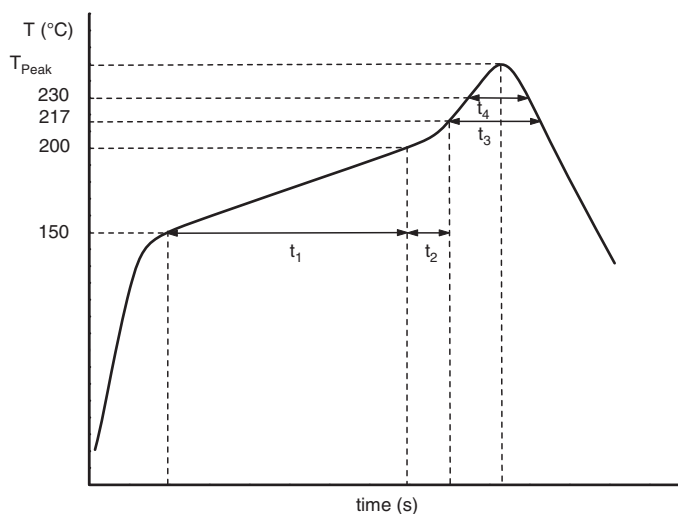

Fig.4 Maximum temperature load during reflow soldering

Table 4

REFLOW SOLDERING CONDITIONS		
PROFILE FEATURES	CASE CODE 0810 to 1014	CASE CODE 1213 to 1216
Max. time from 25 °C to $T_{Peak}$	240 s	200 s
Max. ramp-up rate to 150 °C	3 K/s	3 K/s
Max. time from 150 °C to 200 °C, ( $t_1$ )	150 s	120 s
Ramp up rate from 200 °C to $T_{Peak}$	0.5 K/s to 3 K/s	0.5 K/s to 3 K/s
Max. time from 200 °C to 217 °C, ( $t_2$ )	60 s	60 s
Max. time above $T_{Liquidus}$ (217 °C) ( $t_3$ )	90 s	60 s
Max. time above 230 °C ( $t_4$ )	40 s	30 s
Peak temperature $T_{Peak}$	250 °C	240 °C
Max. time above $T_{Peak}$ minus 5 °C	5 s	10 s
Max. ramp-down rate from $T_{Liquidus}$	6 K/s	6 K/s

**Note**

Temperature measuring point on top of the case and terminals max. 2 runs with pause of min. 30 min in between



Aluminum Capacitors  
SMD (Chip), High Temperature

Vishay BCcomponents

ELECTRICAL DATA	
SYMBOL	DESCRIPTION
$C_R$	rated capacitance at 100 Hz, tolerance $\pm 20\%$
$I_R$	rated RMS ripple current at 100 kHz, 125 °C
$I_{L2}$	max. leakage current after 2 minutes at $U_R$
$\tan \delta$	max. dissipation factor at 100 Hz
$Z$	max. impedance at 100 kHz

**ORDERING EXAMPLE**

Electrolytic capacitor 140 CRH series  
 100  $\mu$ F/50 V;  $\pm 20\%$   
 Nominal case size: 10 x 10 x 14 mm; taped on reel  
 Ordering Code: MAL214097102E3  
 Former 12NC: 2222 140 97102

**Note**

Unless otherwise specified, all electrical values in Table 4 apply at  $T_{amb} = 20\text{ °C}$ ,  $P = 86$  to 106 kPa,  $RH = 45$  to 75 %

Table 5

ELECTRICAL DATA AND ORDERING INFORMATION							
$U_R$ (V)	$C_R$ ( $\mu$ F)	NOMINAL CASE SIZE L x W x H (mm)	$I_R$ 100 kHz 125 °C (mA)	$I_{L2}$ 2 min ( $\mu$ A)	$\tan \delta$ 100 Hz	$Z$ 100 kHz 20 °C ( $\Omega$ )	ORDERING CODE MAL2140.....
6.3	330	8 x 8 x 10	180	21	0.30	0.40	97303E3
	470	10 x 10 x 10	300	30	0.30	0.25	97301E3
	680	10 x 10 x 14	430	43	0.30	0.12	97302E3
10	220	8 x 8 x 10	180	22	0.26	0.40	97403E3
	330	10 x 10 x 10	300	33	0.26	0.25	97401E3
	470	10 x 10 x 14	430	47	0.26	0.12	97402E3
	680	12.5 x 12.5 x 13	750	68	0.22	0.12	97411E3
	1000	12.5 x 12.5 x 16	900	100	0.22	0.09	97412E3
16	150	8 x 8 x 10	180	24	0.22	0.40	97502E3
	330	10 x 10 x 14	430	53	0.22	0.20	97501E3
	470	12.5 x 12.5 x 13	750	75	0.18	0.12	97511E3
	680	12.5 x 12.5 x 16	900	108	0.18	0.09	97512E3
25	100	8 x 8 x 10	180	25	0.18	0.40	97602E3
	220	10 x 10 x 10	300	55	0.18	0.25	97601E3
	330	12.5 x 12.5 x 13	750	82	0.16	0.12	97611E3
	470	12.5 x 12.5 x 16	900	117	0.16	0.09	97612E3
35	68	8 x 8 x 10	180	24	0.14	0.40	97003E3
	100	10 x 10 x 10	255	35	0.14	0.25	97001E3
	150	10 x 10 x 14	317	53	0.14	0.20	97002E3
	220	12.5 x 12.5 x 13	750	77	0.14	0.12	97011E3
	330	12.5 x 12.5 x 13	750	115	0.14	0.12	97012E3
	470	12.5 x 12.5 x 16	900	164	0.14	0.09	97013E3
50	47	8 x 8 x 10	145	24	0.14	0.70	97103E3
	68	10 x 10 x 10	205	34	0.14	0.50	97101E3
	100	10 x 10 x 14	255	50	0.14	0.40	97102E3
	220	12.5 x 12.5 x 13	750	110	0.12	0.23	97111E3
	330	12.5 x 12.5 x 16	900	165	0.12	0.18	97112E3
63	10	8 x 8 x 10	145	6.3	0.12	0.70	97805E3
	22	8 x 8 x 10	145	14	0.12	0.70	97803E3
	33	8 x 8 x 10	145	21	0.12	0.70	97804E3
	47	10 x 10 x 10	205	30	0.12	0.50	97801E3
	68	10 x 10 x 14	255	43	0.12	0.40	97802E3
	100	12.5 x 12.5 x 13	500	63	0.14	0.25	97811E3
	220	12.5 x 12.5 x 16	600	138	0.14	0.20	97812E3



ADDITIONAL ELECTRICAL DATA		
PARAMETER	CONDITIONS	VALUE
<b>Voltage</b>		
Surge voltage for short periods	IEC 60384-18, subclause 4.14	$U_S \leq 1.15 \times U_R$
Reverse voltage for short periods	IEC 60384-18, subclause 4.16	$U_{rev} \leq 1 \text{ V}$
<b>Current</b>		
Leakage current	After 2 minutes at $U_R$	$IL2 \leq 0.0 \times C_R \times U_R$
<b>Inductance</b>		
Equivalent series inductance (ESL)	$\varnothing D = 8 \text{ mm}$	typ. 6 nH
	$\varnothing D = 10 \text{ mm}$	typ. 8 nH
	$\varnothing D \geq 12.5 \text{ mm}$	typ. 11 nH
<b>Resistance</b>		
Equivalent series resistance (ESR) at 100 Hz	Calculated from $\tan \delta_{max}$ and $C_R$ (see Table 4)	$ESR = \tan \delta / 2 \pi f C_R$

### CAPACITANCE (C)

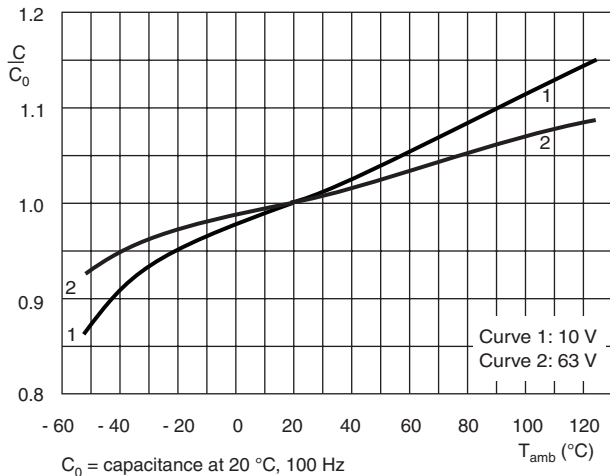

Fig.5 Typical multiplier of capacitance as function of ambient temperature

### DISSIPATION FACTOR ( $\tan \delta$ )

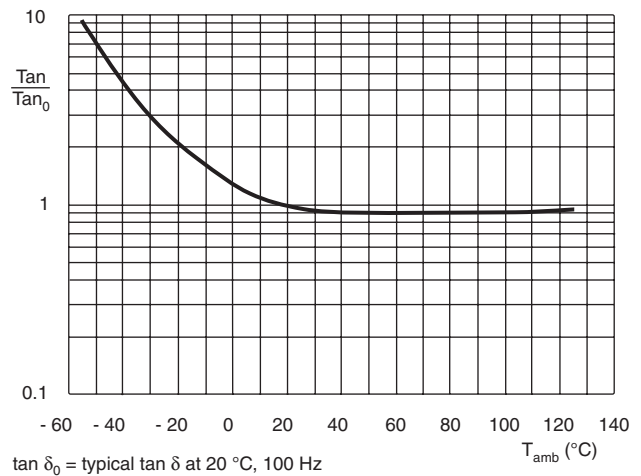
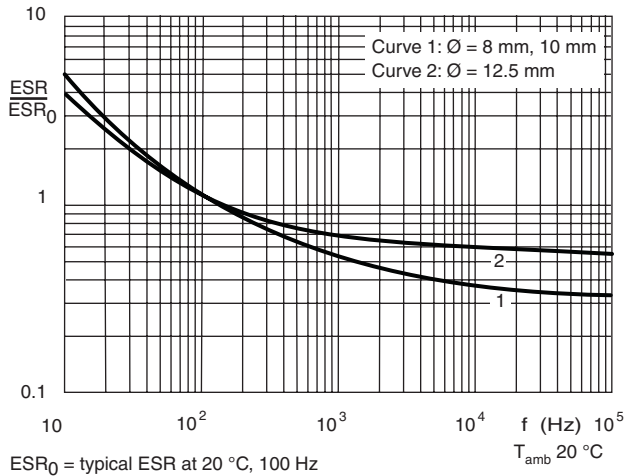

Fig.6 Multiplier of dissipation factor ( $\tan \delta$ ) as function of ambient temperature

**EQUIVALENT SERIES RESISTANCE (ESR)**



$ESR_0$  = typical ESR at 20 °C, 100 Hz

Fig.7 Typical multiplier of ESR as function of frequency

**IMPEDANCE (ESR)**

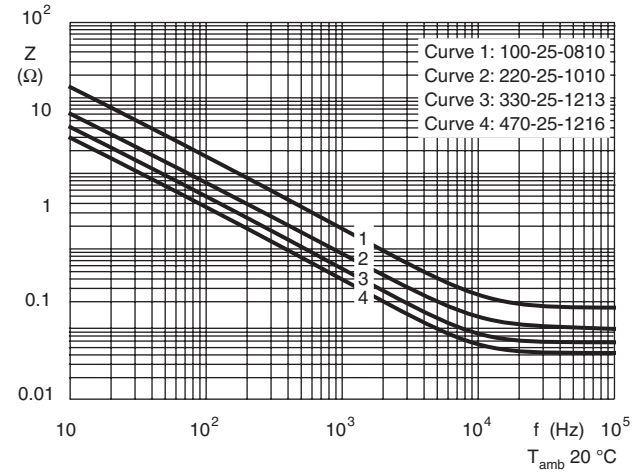

Fig.8 Typical impedance as function of frequency

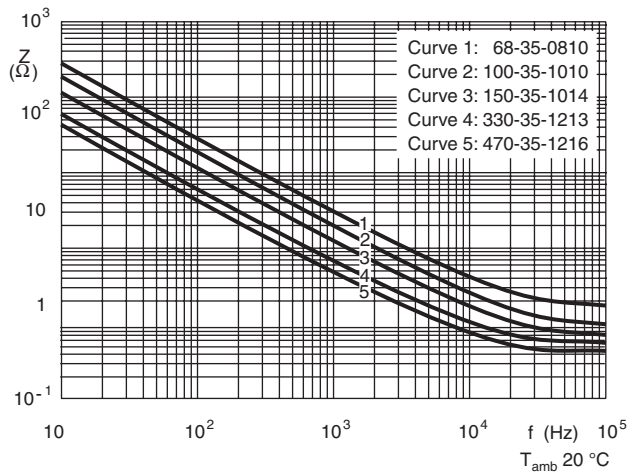

Fig.9 Typical impedance as function of frequency

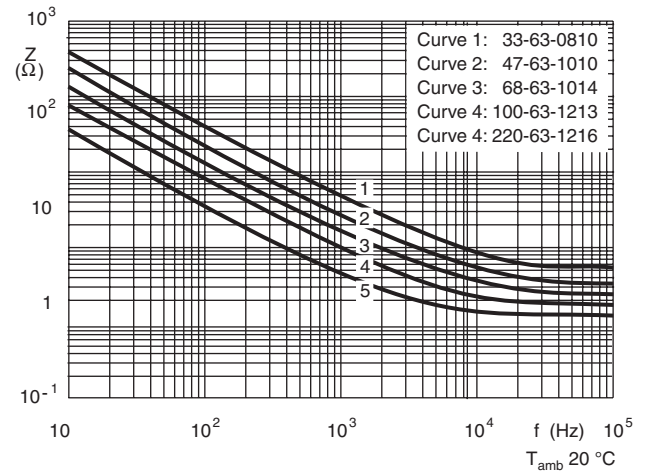

Fig.10 Typical impedance as function of frequency

**RIPPLE CURRENT AND USEFUL LIFE**

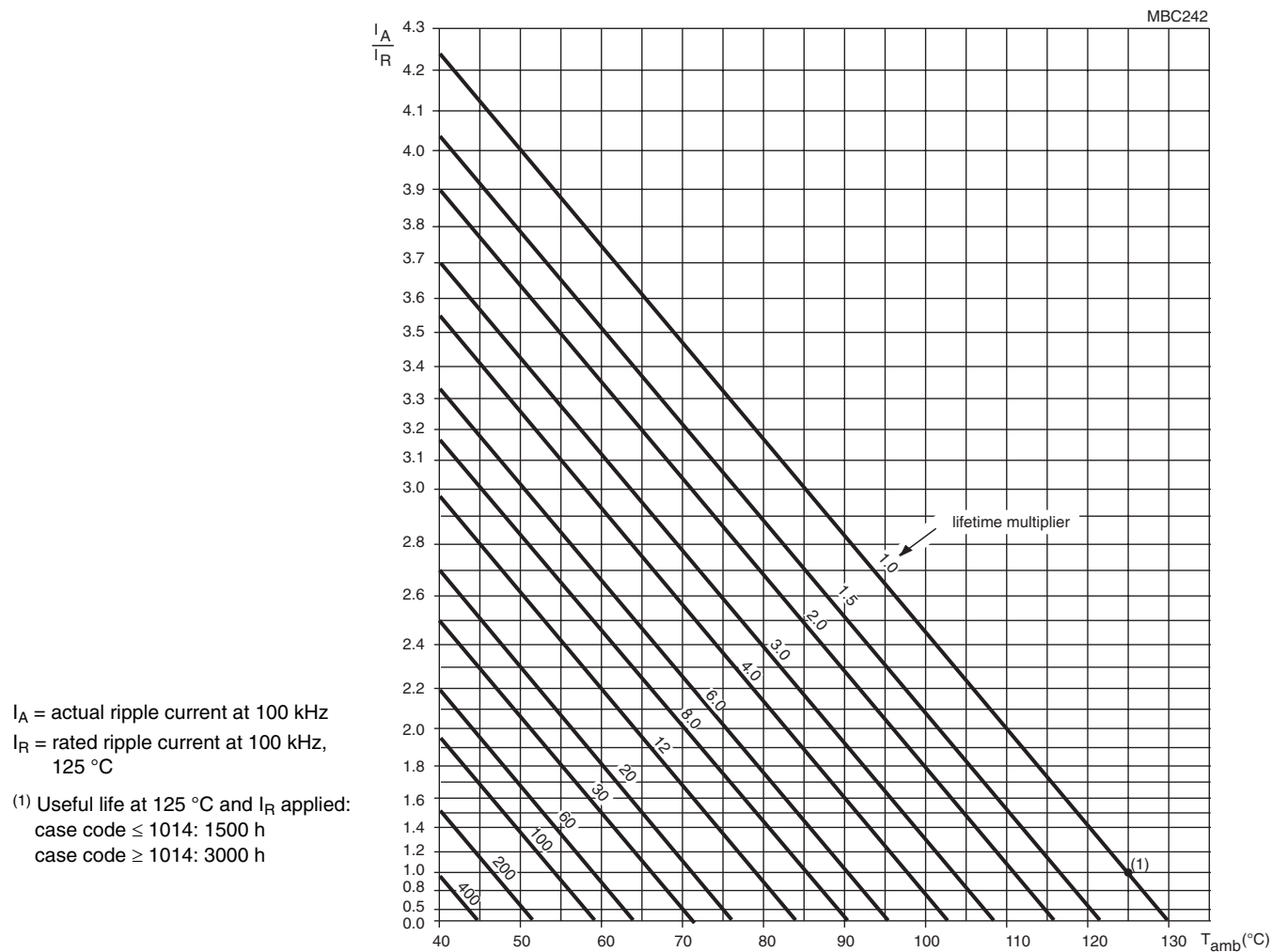

Fig.11 Multiplier of useful life as a function of ambient temperature and ripple current load

Table 6

MULTIPLIER OF RIPPLE CURRENT ( $I_R$ ) AS A FUNCTION OF FREQUENCY			
FREQUENCY (Hz)	$I_R$ MULTIPLIER		
	$U_R = 6.3$ to $25$ V	$U_R = 35$ and $50$ V	$U_R = 63$ V
50	0.60	0.45	0.40
100	0.70	0.60	0.55
300	0.80	0.75	0.70
1000	0.85	0.85	0.85
3000	0.90	0.90	0.90
10 000	0.95	0.95	0.95
30 000	0.97	0.97	0.97
100 000	1.00	1.00	1.00

Table 7

<b>TEST PROCEDURES AND REQUIREMENTS</b>			
<b>TEST</b>		<b>PROCEDURE (quick reference)</b>	<b>REQUIREMENTS</b>
<b>NAME OF TEST</b>	<b>REFERENCE</b>		
Mounting	IEC 60384-18, subclause 4.3	shall be performed prior to tests mentioned below; reflow soldering; for maximum temperature load refer to chapter "Mounting"	$\Delta C/C: \pm 5\%$ $\tan \delta \leq \text{spec. limit}$ $I_{L2} \leq \text{spec. limit}$
Endurance	IEC 60384-18/ CECC 32 300, subclause 4.15	$T_{amb} = 125\text{ }^\circ\text{C}$ ; $U_R$ applied; case size $\leq 10 \times 10 \times 14$ : 1000 h case size $\geq 12.5 \times 12.5 \times 13$ : 2000 h	$U_R = 6.3\text{ V}$ ; $\Delta C/C: \pm 25\%$ $U_R \geq 10\text{ V}$ ; $\Delta C/C: \pm 20\%$ $\tan \delta \leq 2 \times \text{spec. limit}$ $I_{L2} \leq \text{spec. limit}$
Useful life	CECC 30301, subclause 1.8.1	$T_{amb} = 125\text{ }^\circ\text{C}$ ; $U_R$ and $I_R$ applied; case size $\leq 10 \times 10 \times 14$ : 1500 h case size $\geq 12.5 \times 12.5 \times 13$ : 3000 h	$\Delta C/C: \pm 50\%$ $\tan \delta \leq 3 \times \text{spec. limit}$ $I_{L2} \leq \text{spec. limit}$ no short or open circuit' total failure percentage: $\leq 1\%$
Shelf life (storage at high temperature)	IEC 60384-18/ CECC 32 300, subclause 4.17	$T_{amb} = 125\text{ }^\circ\text{C}$ ; no voltage applied; 1000 h after test: $U_R$ to be applied for 30 min, 24 to 48 h before measurement	for requirements see 'Endurance test' above
Reverse voltage	IEC 60384-18/ CECC 32 300, subclause 4.16	$T_{amb} = 125\text{ }^\circ\text{C}$ ; 125 h at $U = -0.5\text{ V}$ , followed by 125 h at $U_R$	$\Delta C/C: \pm 15\%$ $\tan \delta \leq 1.5 \times \text{spec. limit}$ $I_{L2} \leq \text{spec. limit}$





## Disclaimer

All product specifications and data are subject to change without notice.

Vishay Intertechnology, Inc., its affiliates, agents, and employees, and all persons acting on its or their behalf (collectively, "Vishay"), disclaim any and all liability for any errors, inaccuracies or incompleteness contained herein or in any other disclosure relating to any product.

Vishay disclaims any and all liability arising out of the use or application of any product described herein or of any information provided herein to the maximum extent permitted by law. The product specifications do not expand or otherwise modify Vishay's terms and conditions of purchase, including but not limited to the warranty expressed therein, which apply to these products.

No license, express or implied, by estoppel or otherwise, to any intellectual property rights is granted by this document or by any conduct of Vishay.

The products shown herein are not designed for use in medical, life-saving, or life-sustaining applications unless otherwise expressly indicated. Customers using or selling Vishay products not expressly indicated for use in such applications do so entirely at their own risk and agree to fully indemnify Vishay for any damages arising or resulting from such use or sale. Please contact authorized Vishay personnel to obtain written terms and conditions regarding products designed for such applications.

Product names and markings noted herein may be trademarks of their respective owners.

Компания «Океан Электроники» предлагает заключение долгосрочных отношений при поставках импортных электронных компонентов на взаимовыгодных условиях!

Наши преимущества:

- Поставка оригинальных импортных электронных компонентов напрямую с производств Америки, Европы и Азии, а так же с крупнейших складов мира;
- Широкая линейка поставок активных и пассивных импортных электронных компонентов (более 30 млн. наименований);
- Поставка сложных, дефицитных, либо снятых с производства позиций;
- Оперативные сроки поставки под заказ (от 5 рабочих дней);
- Экспресс доставка в любую точку России;
- Помощь Конструкторского Отдела и консультации квалифицированных инженеров;
- Техническая поддержка проекта, помощь в подборе аналогов, поставка прототипов;
- Поставка электронных компонентов под контролем ВП;
- Система менеджмента качества сертифицирована по Международному стандарту ISO 9001;
- При необходимости вся продукция военного и аэрокосмического назначения проходит испытания и сертификацию в лаборатории (по согласованию с заказчиком);
- Поставка специализированных компонентов военного и аэрокосмического уровня качества (Xilinx, Altera, Analog Devices, Intersil, Interpoint, Microsemi, Actel, Aeroflex, Peregrine, VPT, Syfer, Eurofarad, Texas Instruments, MS Kennedy, Miteq, Cobham, E2V, MA-COM, Hittite, Mini-Circuits, General Dynamics и др.);

Компания «Океан Электроники» является официальным дистрибьютором и эксклюзивным представителем в России одного из крупнейших производителей разъемов военного и аэрокосмического назначения «JONHON», а так же официальным дистрибьютором и эксклюзивным представителем в России производителя высокотехнологичных и надежных решений для передачи СВЧ сигналов «FORSTAR».



## JONHON

«JONHON» (основан в 1970 г.)

Разъемы специального, военного и аэрокосмического назначения:

(Применяются в военной, авиационной, аэрокосмической, морской, железнодорожной, горно- и нефтедобывающей отраслях промышленности)

«FORSTAR» (основан в 1998 г.)

ВЧ соединители, коаксиальные кабели, кабельные сборки и микроволновые компоненты:

(Применяются в телекоммуникациях гражданского и специального назначения, в средствах связи, РЛС, а так же военной, авиационной и аэрокосмической отраслях промышленности).



Телефон: 8 (812) 309-75-97 (многоканальный)

Факс: 8 (812) 320-03-32

Электронная почта: [ocean@oceanchips.ru](mailto:ocean@oceanchips.ru)

Web: <http://oceanchips.ru/>

Адрес: 198099, г. Санкт-Петербург, ул. Калинина, д. 2, корп. 4, лит. А