

MC14584B

Hex Schmitt Trigger

The MC14584B Hex Schmitt Trigger is constructed with MOS P-channel and N-channel enhancement mode devices in a single monolithic structure. These devices find primary use where low power dissipation and/or high noise immunity is desired. The MC14584B may be used in place of the MC14069UB hex inverter for enhanced noise immunity to “square up” slowly changing waveforms.

Features

- Supply Voltage Range = 3.0 Vdc to 18 Vdc
- Capable of Driving Two Low-power TTL Loads or One Low-power Schottky TTL Load over the Rated Temperature Range
- Double Diode Protection on All Inputs
- Can Be Used to Replace MC14069UB
- For Greater Hysteresis, Use MC14106B which is Pin-for-Pin Replacement for CD40106B and MM74C14
- These Devices are Pb-Free and are RoHS Compliant

MAXIMUM RATINGS (Voltages Referenced to V_{SS})

| Symbol | Parameter | Value | Unit |
|-------------------|---|------------------------|-------------|
| V_{DD} | DC Supply Voltage Range | -0.5 to +18.0 | V |
| V_{in}, V_{out} | Input or Output Voltage Range (DC or Transient) | -0.5 to $V_{DD} + 0.5$ | V |
| I_{in}, I_{out} | Input or Output Current (DC or Transient) per Pin | ± 10 | mA |
| P_D | Power Dissipation, per Package (Note 1) | 500 | mW |
| T_A | Ambient Temperature Range | -55 to +125 | $^{\circ}C$ |
| T_{stg} | Storage Temperature Range | -65 to +150 | $^{\circ}C$ |
| T_L | Lead Temperature (8-Second Soldering) | 260 | $^{\circ}C$ |

Stresses exceeding Maximum Ratings may damage the device. Maximum Ratings are stress ratings only. Functional operation above the Recommended Operating Conditions is not implied. Extended exposure to stresses above the Recommended Operating Conditions may affect device reliability.

1. Temperature Derating:

Plastic “P and D/DW” Packages: - 7.0 mW/ $^{\circ}C$ From 65 $^{\circ}C$ To 125 $^{\circ}C$

This device contains protection circuitry to guard against damage due to high static voltages or electric fields. However, precautions must be taken to avoid applications of any voltage higher than maximum rated voltages to this high-impedance circuit. For proper operation, V_{in} and V_{out} should be constrained to the range $V_{SS} \leq (V_{in} \text{ or } V_{out}) \leq V_{DD}$.

Unused inputs must always be tied to an appropriate logic voltage level (e.g., either V_{SS} or V_{DD}). Unused outputs must be left open.



ON Semiconductor®

<http://onsemi.com>

MARKING DIAGRAMS

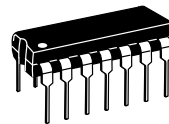

PDIP-14
P SUFFIX
CASE 646

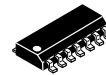
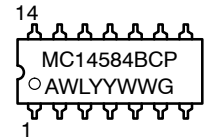

SOIC-14
D SUFFIX
CASE 751A

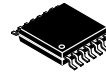
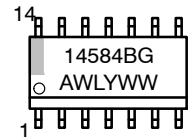

TSSOP-14
DT SUFFIX
CASE 948G

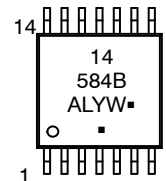

SOEIAJ-14
F SUFFIX
CASE 965

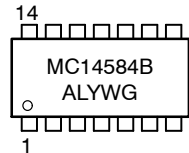

- A = Assembly Location
- WL, L = Wafer Lot
- YY, Y = Year
- WW, W = Work Week
- G or ■ = Pb-Free Package

(Note: Microdot may be in either location)

ORDERING INFORMATION

See detailed ordering and shipping information in the package dimensions section on page 2 of this data sheet.

MC14584B

PIN ASSIGNMENT

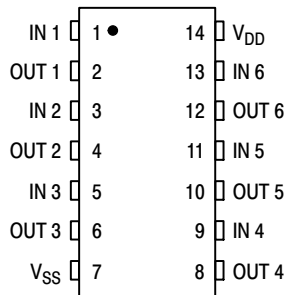

LOGIC DIAGRAM

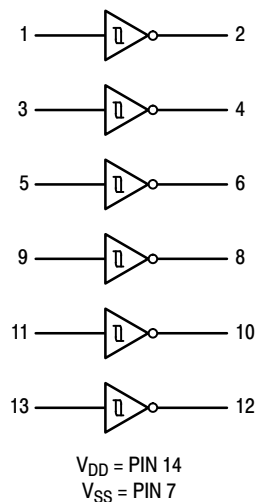

EQUIVALENT CIRCUIT SCHEMATIC (1/6 OF CIRCUIT SHOWN)

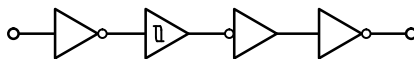

ORDERING INFORMATION

| Device | Package | Shipping [†] |
|---------------|------------------------|-----------------------|
| MC14584BCPG | PDIP-14 (Pb-Free) | 500 Units / Rail |
| MC14584BDG | SOIC-14 (Pb-Free) | 55 Units / Rail |
| MC14584BDR2G | SOIC-14 (Pb-Free) | 2500 / Tape & Reel |
| MC14584BDTR2G | TSSOP-14* | |
| MC14584BFG | SOEIAJ-14 (Pb-Free) | 50 Units / Rail |
| MC14584BFELG | SOEIAJ-14 (Pb-Free) | 2000 / Tape & Reel |

[†]For information on tape and reel specifications, including part orientation and tape sizes, please refer to our Tape and Reel Packaging Specifications Brochure, BRD8011/D.

*This package is inherently Pb-Free.

MC14584B

ELECTRICAL CHARACTERISTICS (Voltages Referenced to V_{SS})

| Characteristic | Symbol | V _{DD} Vdc | - 55°C | | 25°C | | | 125°C | | Unit |
|--|-------------------------------|------------------------|---|------|-------|--------------------|------|-------|------|------|
| | | | Min | Max | Min | Typ ⁽²⁾ | Max | Min | Max | |
| Output Voltage V _{in} = V _{DD} V _{in} = 0 | "0" Level V _{OL} | 5.0 | - | 0.05 | - | 0 | 0.05 | - | 0.05 | Vdc |
| | | 10 | - | 0.05 | - | 0 | 0.05 | - | 0.05 | |
| | | 15 | - | 0.05 | - | 0 | 0.05 | - | 0.05 | |
| | "1" Level V _{OH} | 5.0 | 4.95 | - | 4.95 | 5.0 | - | 4.95 | - | |
| | | 10 | 9.95 | - | 9.95 | 10 | - | 9.95 | - | |
| | | 15 | 14.95 | - | 14.95 | 15 | - | 14.95 | - | |
| Output Drive Current (V _{OH} = 2.5 Vdc) (V _{OH} = 4.6 Vdc) (V _{OH} = 9.5 Vdc) (V _{OH} = 13.5 Vdc) (V _{OL} = 0.4 Vdc) (V _{OL} = 0.5 Vdc) (V _{OL} = 1.5 Vdc) | Source I _{OH} | 5.0 | -3.0 | - | -2.4 | -4.2 | - | -1.7 | - | mAdc |
| | | 5.0 | -0.64 | - | -0.51 | -0.88 | - | -0.36 | - | |
| | | 10 | -1.6 | - | -1.3 | -2.25 | - | -0.9 | - | |
| | Sink I _{OL} | 5.0 | 0.64 | - | 0.51 | 0.88 | - | 0.36 | - | |
| | | 10 | 1.6 | - | 1.3 | 2.25 | - | 0.9 | - | |
| | | 15 | 4.2 | - | 3.4 | 8.8 | - | 2.4 | - | |
| Input Current | I _{in} | 15 | - | ±0.1 | - | ±0.00001 | ±0.1 | - | ±1.0 | µAdc |
| Input Capacitance (V _{in} = 0) | C _{in} | - | - | - | - | 5.0 | 7.5 | - | - | pF |
| Quiescent Current (Per Package) | I _{DD} | 5.0 | - | 0.25 | - | 0.0005 | 0.25 | - | 7.5 | µAdc |
| | | 10 | - | 0.5 | - | 0.0010 | 0.5 | - | 15 | |
| | | 15 | - | 1.0 | - | 0.0015 | 1.0 | - | 30 | |
| Total Supply Current ^{(3) (4)} (Dynamic plus Quiescent, Per Package) (C _L = 50 pF on all outputs, all buffers switching) | I _T | 5.0 | I _T = (1.8 µA/kHz) f + I _{DD} | | | | | | | µAdc |
| | | 10 | I _T = (3.6 µA/kHz) f + I _{DD} | | | | | | | |
| | | 15 | I _T = (5.4 µA/kHz) f + I _{DD} | | | | | | | |
| Hysteresis Voltage | V _H ⁽⁵⁾ | 5.0 | 0.27 | 1.0 | 0.25 | 0.6 | 1.0 | 0.21 | 1.0 | Vdc |
| | | 10 | 0.36 | 1.3 | 0.3 | 0.7 | 1.2 | 0.25 | 1.2 | |
| | | 15 | 0.77 | 1.7 | 0.6 | 1.1 | 1.5 | 0.50 | 1.4 | |
| Threshold Voltage Positive-Going Negative-Going | V _{T+} | 5.0 | 1.9 | 3.5 | 1.8 | 2.7 | 3.4 | 1.7 | 3.4 | Vdc |
| | | 10 | 3.4 | 7.0 | 3.3 | 5.3 | 6.9 | 3.2 | 6.9 | |
| | | 15 | 5.2 | 10.6 | 5.2 | 8.0 | 10.5 | 5.2 | 10.5 | |
| | V _{T-} | 5.0 | 1.6 | 3.3 | 1.6 | 2.1 | 3.2 | 1.5 | 3.2 | |
| | | 10 | 3.0 | 6.7 | 3.0 | 4.6 | 6.7 | 3.0 | 6.7 | |
| | | 15 | 4.5 | 9.7 | 4.6 | 6.9 | 9.8 | 4.7 | 9.9 | |

2. Data labelled "Typ" is not to be used for design purposes but is intended as an indication of the IC's potential performance.

3. The formulas given are for the typical characteristics only at 25°C.

4. To calculate total supply current at loads other than 50 pF:

$$I_T(C_L) = I_T(50 \text{ pF}) + (C_L - 50) \text{ Vfk}$$

where: I_T is in µA (per package), C_L in pF, V = (V_{DD} - V_{SS}) in volts, f in kHz is input frequency, and k = 0.001.

5. V_H = V_{T+} - V_{T-} (But maximum variation of V_H is specified as less than V_{T+ max} - V_{T- min}).

SWITCHING CHARACTERISTICS (C_L = 50 pF, T_A = 25°C)

| Characteristic | Symbol | V _{DD} Vdc | Min | Typ ⁽⁶⁾ | Max | Unit |
|------------------------|-------------------------------------|------------------------|-----|--------------------|-----|------|
| Output Rise Time | t _{TLH} | 5.0 | - | 100 | 200 | ns |
| | | 10 | - | 50 | 100 | |
| | | 15 | - | 40 | 80 | |
| Output Fall Time | t _{THL} | 5.0 | - | 100 | 200 | ns |
| | | 10 | - | 50 | 100 | |
| | | 15 | - | 40 | 80 | |
| Propagation Delay Time | t _{PLH} , t _{PHL} | 5.0 | - | 125 | 250 | ns |
| | | 10 | - | 50 | 100 | |
| | | 15 | - | 40 | 80 | |

6. Data labelled "Typ" is not to be used for design purposes but is intended as an indication of the IC's potential performance.

MC14584B

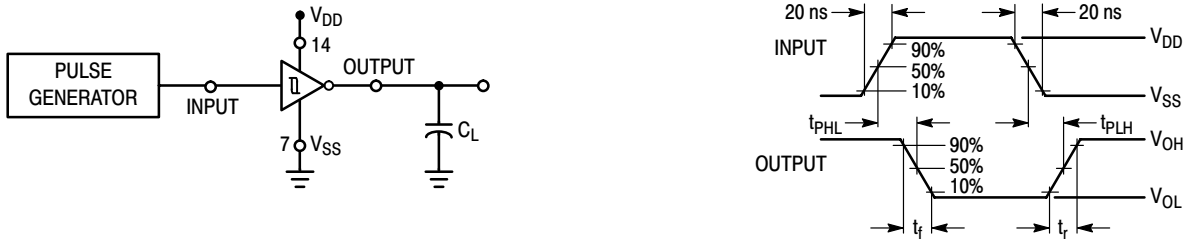

Figure 1. Switching Time Test Circuit and Waveforms

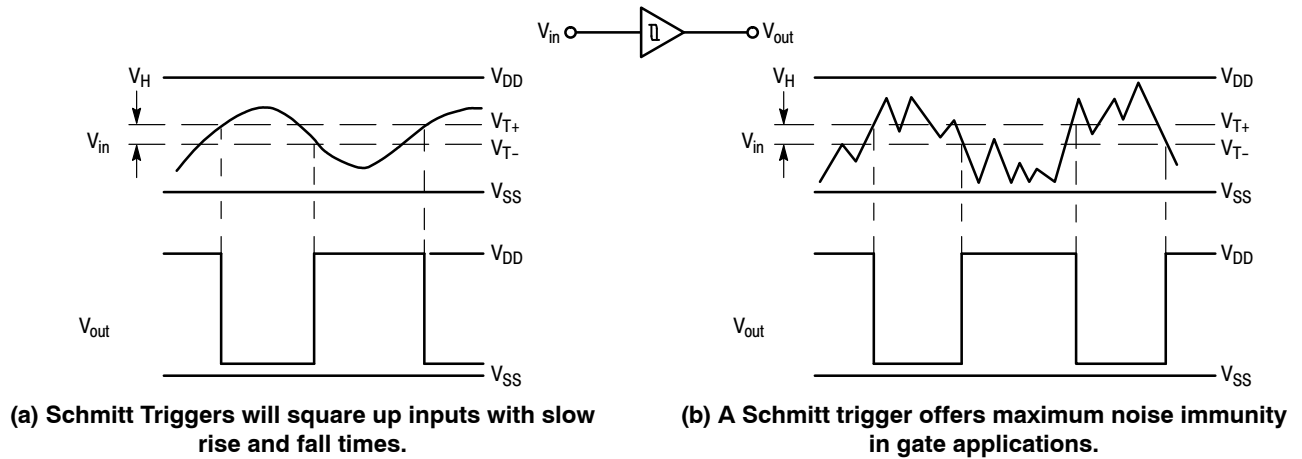

Figure 2. Typical Schmitt Trigger Applications

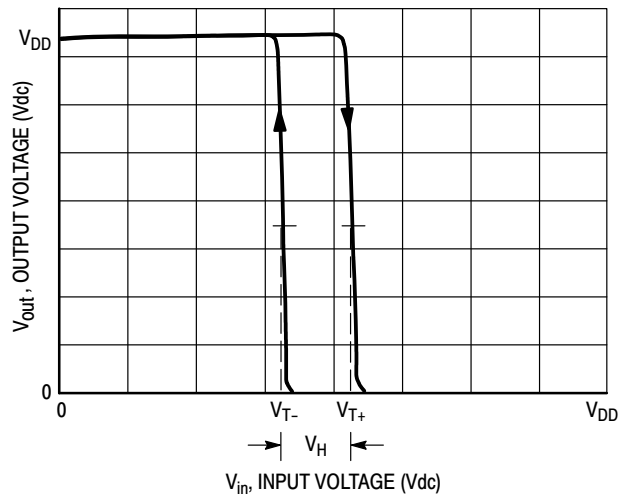
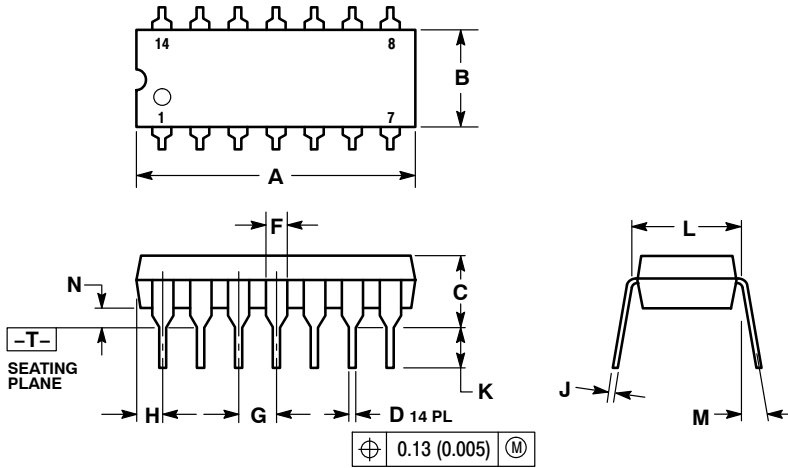

Figure 3. Typical Transfer Characteristics

MC14584B

PACKAGE DIMENSIONS

PDIP-14
CASE 646-06
ISSUE P



NOTES:

1. DIMENSIONING AND TOLERANCING PER ANSI Y14.5M, 1982.
2. CONTROLLING DIMENSION: INCH.
3. DIMENSION L TO CENTER OF LEADS WHEN FORMED PARALLEL.
4. DIMENSION B DOES NOT INCLUDE MOLD FLASH.
5. ROUNDED CORNERS OPTIONAL.

| DIM | INCHES | | MILLIMETERS | |
|-----|-----------|-------|-------------|-------|
| | MIN | MAX | MIN | MAX |
| A | 0.715 | 0.770 | 18.16 | 19.56 |
| B | 0.240 | 0.260 | 6.10 | 6.60 |
| C | 0.145 | 0.185 | 3.69 | 4.69 |
| D | 0.015 | 0.021 | 0.38 | 0.53 |
| F | 0.040 | 0.070 | 1.02 | 1.78 |
| G | 0.100 BSC | | 2.54 BSC | |
| H | 0.052 | 0.095 | 1.32 | 2.41 |
| J | 0.008 | 0.015 | 0.20 | 0.38 |
| K | 0.115 | 0.135 | 2.92 | 3.43 |
| L | 0.290 | 0.310 | 7.37 | 7.87 |
| M | --- | 10° | --- | 10° |
| N | 0.015 | 0.039 | 0.38 | 1.01 |

MC14584B

PACKAGE DIMENSIONS

SOIC-14
CASE 751A-03
ISSUE J

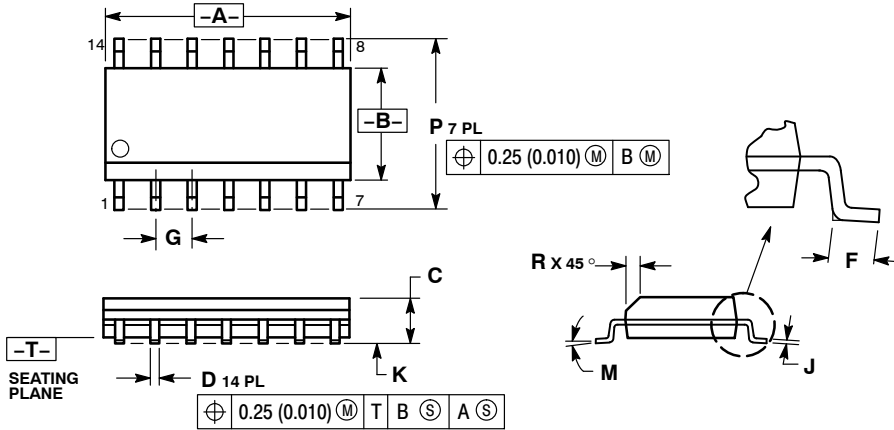

NOTES:

1. DIMENSIONING AND TOLERANCING PER ANSI Y14.5M, 1982.
2. CONTROLLING DIMENSION: MILLIMETER.
3. DIMENSIONS A AND B DO NOT INCLUDE MOLD PROTRUSION.
4. MAXIMUM MOLD PROTRUSION 0.15 (0.006) PER SIDE.
5. DIMENSION D DOES NOT INCLUDE DAMBAR PROTRUSION. ALLOWABLE DAMBAR PROTRUSION SHALL BE 0.127 (0.005) TOTAL IN EXCESS OF THE D DIMENSION AT MAXIMUM MATERIAL CONDITION.

| DIM | MILLIMETERS | | INCHES | |
|-----|-------------|------|-----------|-------|
| | MIN | MAX | MIN | MAX |
| A | 8.55 | 8.75 | 0.337 | 0.344 |
| B | 3.80 | 4.00 | 0.150 | 0.157 |
| C | 1.35 | 1.75 | 0.054 | 0.068 |
| D | 0.35 | 0.49 | 0.014 | 0.019 |
| F | 0.40 | 1.25 | 0.016 | 0.049 |
| G | 1.27 BSC | | 0.050 BSC | |
| J | 0.19 | 0.25 | 0.008 | 0.009 |
| K | 0.10 | 0.25 | 0.004 | 0.009 |
| M | 0° | 7° | 0° | 7° |
| P | 5.80 | 6.20 | 0.228 | 0.244 |
| R | 0.25 | 0.50 | 0.010 | 0.019 |

SOLDERING FOOTPRINT*

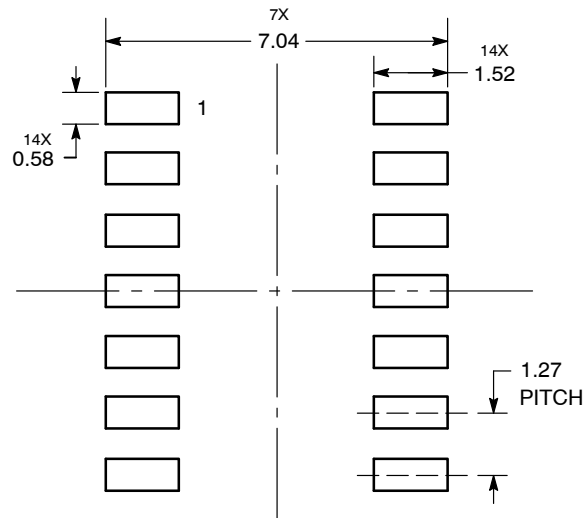

DIMENSIONS: MILLIMETERS

*For additional information on our Pb-Free strategy and soldering details, please download the ON Semiconductor Soldering and Mounting Techniques Reference Manual, SOLDERRM/D.

MC14584B

PACKAGE DIMENSIONS

TSSOP-14
CASE 948G-01
ISSUE B

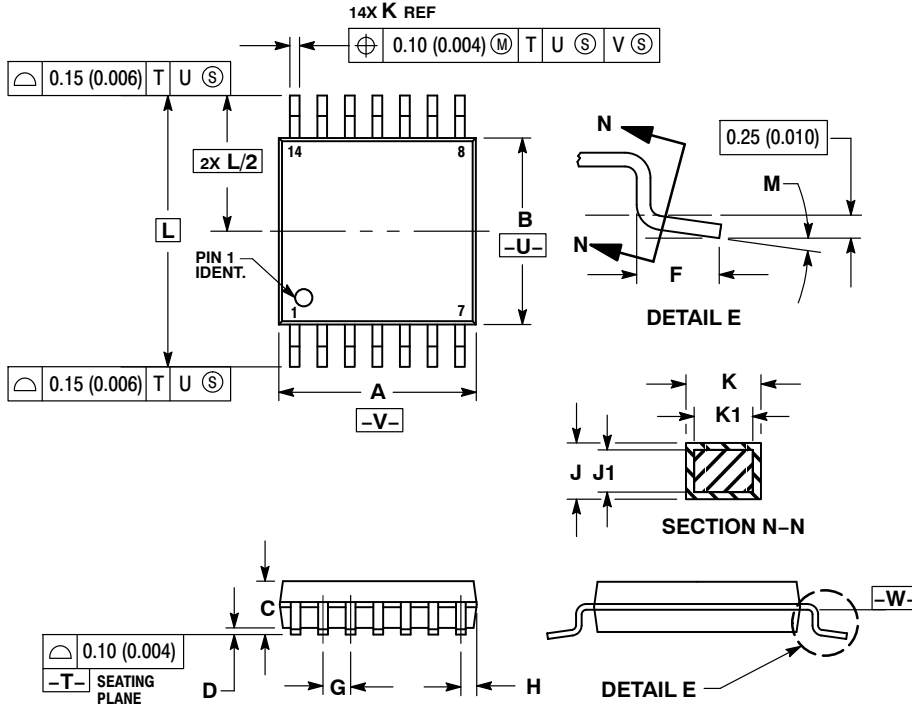

- NOTES:
1. DIMENSIONING AND TOLERANCING PER ANSI Y14.5M, 1982.
 2. CONTROLLING DIMENSION: MILLIMETER.
 3. DIMENSION A DOES NOT INCLUDE MOLD FLASH, PROTRUSIONS OR GATE BURRS. MOLD FLASH OR GATE BURRS SHALL NOT EXCEED 0.15 (0.006) PER SIDE.
 4. DIMENSION B DOES NOT INCLUDE INTERLEAD FLASH OR PROTRUSION. INTERLEAD FLASH OR PROTRUSION SHALL NOT EXCEED 0.25 (0.010) PER SIDE.
 5. DIMENSION K DOES NOT INCLUDE DAMBAR PROTRUSION. ALLOWABLE DAMBAR PROTRUSION SHALL BE 0.08 (0.003) TOTAL IN EXCESS OF THE K DIMENSION AT MAXIMUM MATERIAL CONDITION.
 6. TERMINAL NUMBERS ARE SHOWN FOR REFERENCE ONLY.
 7. DIMENSION A AND B ARE TO BE DETERMINED AT DATUM PLANE -W-.

| DIM | MILLIMETERS | | INCHES | |
|-----|-------------|------|-----------|-------|
| | MIN | MAX | MIN | MAX |
| A | 4.90 | 5.10 | 0.193 | 0.200 |
| B | 4.30 | 4.50 | 0.169 | 0.177 |
| C | --- | 1.20 | --- | 0.047 |
| D | 0.05 | 0.15 | 0.002 | 0.006 |
| F | 0.50 | 0.75 | 0.020 | 0.030 |
| G | 0.65 BSC | | 0.026 BSC | |
| H | 0.50 | 0.60 | 0.020 | 0.024 |
| J | 0.09 | 0.20 | 0.004 | 0.008 |
| J1 | 0.09 | 0.16 | 0.004 | 0.006 |
| K | 0.19 | 0.30 | 0.007 | 0.012 |
| K1 | 0.19 | 0.25 | 0.007 | 0.010 |
| L | 6.40 BSC | | 0.252 BSC | |
| M | 0° | 8° | 0° | 8° |

SOLDERING FOOTPRINT*

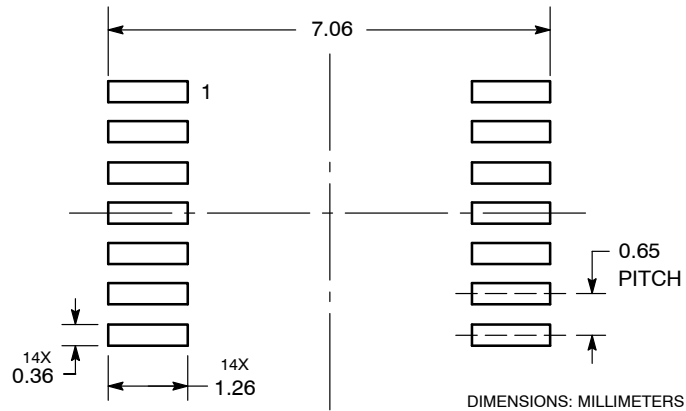

*For additional information on our Pb-Free strategy and soldering details, please download the ON Semiconductor Soldering and Mounting Techniques Reference Manual, SOLDERRM/D.

MC14584B

PACKAGE DIMENSIONS

SOEIAJ-14
CASE 965-01
ISSUE B

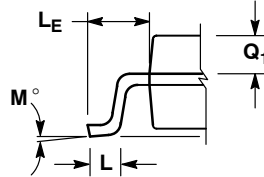
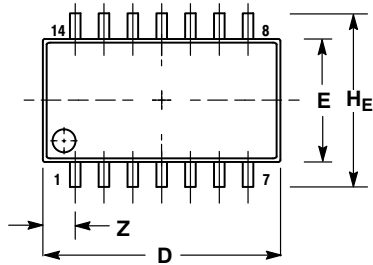

DETAIL P

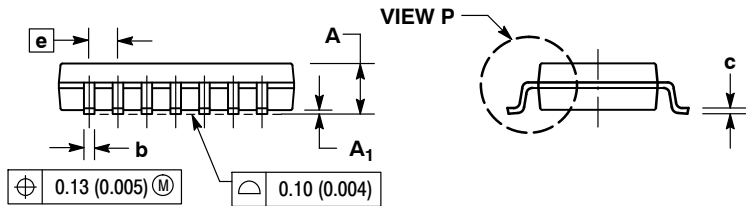

NOTES:

1. DIMENSIONING AND TOLERANCING PER ANSI Y14.5M, 1982.
2. CONTROLLING DIMENSION: MILLIMETER.
3. DIMENSIONS D AND E DO NOT INCLUDE MOLD FLASH OR PROTRUSIONS AND ARE MEASURED AT THE PARTING LINE. MOLD FLASH OR PROTRUSIONS SHALL NOT EXCEED 0.15 (0.006) PER SIDE.
4. TERMINAL NUMBERS ARE SHOWN FOR REFERENCE ONLY.
5. THE LEAD WIDTH DIMENSION (b) DOES NOT INCLUDE DAMBAR PROTRUSION. ALLOWABLE DAMBAR PROTRUSION SHALL BE 0.08 (0.003) TOTAL IN EXCESS OF THE LEAD WIDTH DIMENSION AT MAXIMUM MATERIAL CONDITION. DAMBAR CANNOT BE LOCATED ON THE LOWER RADIUS OR THE FOOT. MINIMUM SPACE BETWEEN PROTRUSIONS AND ADJACENT LEAD TO BE 0.46 (0.018).

| DIM | MILLIMETERS | | INCHES | |
|----------------|-------------|-------|-----------|-------|
| | MIN | MAX | MIN | MAX |
| A | --- | 2.05 | --- | 0.081 |
| A ₁ | 0.05 | 0.20 | 0.002 | 0.008 |
| b | 0.35 | 0.50 | 0.014 | 0.020 |
| c | 0.10 | 0.20 | 0.004 | 0.008 |
| D | 9.90 | 10.50 | 0.390 | 0.413 |
| E | 5.10 | 5.45 | 0.201 | 0.215 |
| e | 1.27 BSC | | 0.050 BSC | |
| H _E | 7.40 | 8.20 | 0.291 | 0.323 |
| L | 0.50 | 0.85 | 0.020 | 0.033 |
| L _F | 1.10 | 1.50 | 0.043 | 0.059 |
| M | 0° | 10° | 0° | 10° |
| Q ₁ | 0.70 | 0.90 | 0.028 | 0.035 |
| Z | --- | 1.42 | --- | 0.056 |

ON Semiconductor and are registered trademarks of Semiconductor Components Industries, LLC (SCILLC). SCILLC reserves the right to make changes without further notice to any products herein. SCILLC makes no warranty, representation or guarantee regarding the suitability of its products for any particular purpose, nor does SCILLC assume any liability arising out of the application or use of any product or circuit, and specifically disclaims any and all liability, including without limitation special, consequential or incidental damages. "Typical" parameters which may be provided in SCILLC data sheets and/or specifications can and do vary in different applications and actual performance may vary over time. All operating parameters, including "Typicals" must be validated for each customer application by customer's technical experts. SCILLC does not convey any license under its patent rights nor the rights of others. SCILLC products are not designed, intended, or authorized for use as components in systems intended for surgical implant into the body, or other applications intended to support or sustain life, or for any other application in which the failure of the SCILLC product could create a situation where personal injury or death may occur. Should Buyer purchase or use SCILLC products for any such unintended or unauthorized application, Buyer shall indemnify and hold SCILLC and its officers, employees, subsidiaries, affiliates, and distributors harmless against all claims, costs, damages, and expenses, and reasonable attorney fees arising out of, directly or indirectly, any claim of personal injury or death associated with such unintended or unauthorized use, even if such claim alleges that SCILLC was negligent regarding the design or manufacture of the part. SCILLC is an Equal Opportunity/Affirmative Action Employer. This literature is subject to all applicable copyright laws and is not for resale in any manner.

PUBLICATION ORDERING INFORMATION

LITERATURE FULFILLMENT:
Literature Distribution Center for ON Semiconductor
P.O. Box 5163, Denver, Colorado 80217 USA
Phone: 303-675-2175 or 800-344-3860 Toll Free USA/Canada
Fax: 303-675-2176 or 800-344-3867 Toll Free USA/Canada
Email: orderlit@onsemi.com

N. American Technical Support: 800-282-9855 Toll Free
USA/Canada
Europe, Middle East and Africa Technical Support:
Phone: 421 33 790 2910
Japan Customer Focus Center
Phone: 81-3-5773-3850

ON Semiconductor Website: www.onsemi.com
Order Literature: <http://www.onsemi.com/orderlit>
For additional information, please contact your local Sales Representative

Компания «Океан Электроники» предлагает заключение долгосрочных отношений при поставках импортных электронных компонентов на взаимовыгодных условиях!

Наши преимущества:

- Поставка оригинальных импортных электронных компонентов напрямую с производств Америки, Европы и Азии, а так же с крупнейших складов мира;
- Широкая линейка поставок активных и пассивных импортных электронных компонентов (более 30 млн. наименований);
- Поставка сложных, дефицитных, либо снятых с производства позиций;
- Оперативные сроки поставки под заказ (от 5 рабочих дней);
- Экспресс доставка в любую точку России;
- Помощь Конструкторского Отдела и консультации квалифицированных инженеров;
- Техническая поддержка проекта, помощь в подборе аналогов, поставка прототипов;
- Поставка электронных компонентов под контролем ВП;
- Система менеджмента качества сертифицирована по Международному стандарту ISO 9001;
- При необходимости вся продукция военного и аэрокосмического назначения проходит испытания и сертификацию в лаборатории (по согласованию с заказчиком);
- Поставка специализированных компонентов военного и аэрокосмического уровня качества (Xilinx, Altera, Analog Devices, Intersil, Interpoint, Microsemi, Actel, Aeroflex, Peregrine, VPT, Syfer, Eurofarad, Texas Instruments, MS Kennedy, Miteq, Cobham, E2V, MA-COM, Hittite, Mini-Circuits, General Dynamics и др.);

Компания «Океан Электроники» является официальным дистрибьютором и эксклюзивным представителем в России одного из крупнейших производителей разъемов военного и аэрокосмического назначения «**JONHON**», а так же официальным дистрибьютором и эксклюзивным представителем в России производителя высокотехнологичных и надежных решений для передачи СВЧ сигналов «**FORSTAR**».



JONHON

«**JONHON**» (основан в 1970 г.)

Разъемы специального, военного и аэрокосмического назначения:

(Применяются в военной, авиационной, аэрокосмической, морской, железнодорожной, горно- и нефтедобывающей отраслях промышленности)

«**FORSTAR**» (основан в 1998 г.)

ВЧ соединители, коаксиальные кабели,
кабельные сборки и микроволновые компоненты:

(Применяются в телекоммуникациях гражданского и специального назначения, в средствах связи, РЛС, а так же военной, авиационной и аэрокосмической отраслях промышленности).



Телефон: 8 (812) 309-75-97 (многоканальный)

Факс: 8 (812) 320-03-32

Электронная почта: ocean@oceanchips.ru

Web: <http://oceanchips.ru/>

Адрес: 198099, г. Санкт-Петербург, ул. Калинина, д. 2, корп. 4, лит. А