

# EMI Filtered Connectors

*from performance to board space, to cost, we offer many reasons and options for managing EMI @ the signal & power I/O*



**Series F Ferrite Filtered Connectors** offer a low cost, space saving solution for high frequency interference... **FC3-FC7**

**Series 500 Low-Profile Feed-Through Connectors** deliver reliable EMI filtering in 90° PCB and straight PCB connectors... **FC8-FC11**

**Series 600 Hi-Density Filtered Connectors** meet the growing need for increased circuit densities in smaller packages... **FC12-FC13**

**Series 700 High Performance Connectors** feature feed-through capacitive and PI filters for the most effective filtering... **FC16-FC37**

**Filtered Combo D-Sub Connectors** use tubular capacitors for high insertion loss in signal, power and coaxial contacts... **FC38-FC48**

**Micro D Series Connectors** allow designers to incorporate EMI filtering into even smaller packages... **FC49-FC53**

**Datacom Connectors** including modular jack, miniature ribbon and mini-DIN protect critical datacom lines... **FC54-FC58**

**USB Connectors** incorporate EMI filtering and ESD protection into standard USB packages freeing up valuable board space... **FC59**

**Hooded Strain Reliefs** for shock protection from exposed wires and short circuits... **FC60**

**Performance Specifications & Board/Panel Cutouts**... **FC62-FC64**



## Advantages of a Filtered Connector

- **Low ground impedance** – Full ground plate and metallic shell provide minimal impedance and superior performance compared to on-board filter with high impedance
- **Eliminate re-radiation** – Filtered connector at interface leaves no path for bypassing the filter
- **Ground plane shielding** – API's filtered connector ground planes shield the box even at the connector port
- **Efficient space utilization** – Filters located in the connectors provide additional space on PCB board
- **Consistent performance** – Filtered connectors provide more consistent pin to pin performance
- **Fewer components** – Filtered connectors reduce component count creating cost savings
- **Reliability** – API tests 100% of filters, on-board filters are usually spot tested

# Advantages of API Filtered Connectors

API Technologies' Spectrum Control brand offers the industry's most complete line of filtered D-subminiature connectors. Our connectors are available in shell sizes from 9 to 50, and come in many termination types, such as PC mount, wire wrap, solder cup and 90° PCB. In addition, API offers a wide range of filtering options, allowing you to find the right balance between performance and economy.

EMI filter options include our Pi filter configuration, which provides 45-60 dB per decade slope to insertion loss curve, our capacitive-only C filters that provide cost-effective EMI attenuation, ferrite filtered series F connectors (designed for filtering in situations that do not tolerate capacitive loading of circuit), as well as our series 500 connectors, with small .318" footprints.

The construction of our high performance Series 600 and 700 connectors features a one-piece zinc diecast shell, which is subsequently nickel-plated. Each filter is constructed with 360° grounding with ground plate, and our patented coaxial springs ensure ground continuity. And with API's advanced in-house ceramic tube design, you'll get a reliable, high performance filter from start to finish.

## Advantages of an API Filtered Connector

- **Low ground impedance** – Full ground plate and metallic shell provide minimal impedance and superior performance compared to on-board filter with high impedance
- **Eliminate re-radiation** – Filtered connector at interface leaves no path for bypassing the filter
- **Ground plane shielding** – API filtered connector ground planes shield the box even at the connector port
- **Efficient space utilization** – Filters located in connector provides additional space on PCB board
- **Consistent performance** – Filtered connectors provide more consistent pin to pin performance
- **Fewer components** – Filtered connectors reduce component count creating cost savings
- **Reliability** – API tests 100% of filters, on-board filters are usually spot tested



# Series F Ferrite Filtered Connectors

The Series F filtered D-subminiature connectors incorporate a solid slab of ferrite material as the filtering element. This rugged one-piece design provides a com-compact connector that is a drop-in replacement for standard connectors. The ferrite material has been chosen for optimum filtering performance in the 10 to 300 MHz range.

## Series F Applications

- Personal computers, microcomputer-applied products and peripheral/terminal equipment
- Eliminates common-mode noise along data lines in data communication terminals and digital equipment

## Features

- Low cost, high performance ferrite filter
- No distortion of wave forms
- Replaces individual ferrite bead filters, saving cost and space
- Provides both pin to ground and pin to pin filtering
- Effective in helping meet requirements of FCC, VDE, EN55022 and Japan's VCCI
- Short, space saving .318" footprint
- Interchangeable with standard D-subminiature connectors
- Can be installed directly over PCB trace pattern with no shorting
- 4-40 UNC locking insert eliminates loose hardware
- Metal shielding front shell
- Gold plated contacts
- RoHS compliant versions available (replace 56- with 56F)



## Mechanical Specifications

Front Shell . . . . . Steel (Tin plated)  
Housing . . . . . UL 94V-0 Rated thermoplastic, black  
Contacts . . . . . Phosphor bronze (sockets)  
or brass (pins)  
Contact  
Plating . . . . . Gold Flash (<10µ in.) over nickel  
Operating  
Temperature . . . . . -40°C to +105°C

## Electrical Specifications

| Frequency (MHz) | Impedance (Ohms) |          |
|-----------------|------------------|----------|
|                 | Right Angle      | Vertical |
| 1               | 2                | 1        |
| 10              | 15               | 6        |
| 30              | 20               | 10       |
| 50              | 23               | 12       |
| 100             | 27               | 15       |

Frequency  
Range . . . . . 10 – 300 MHz  
Current  
Rating . . . . . 5 Amps  
Dielectric  
Withstand Voltage . . 1000 VAC for one minute  
Insulation  
Resistance . . . . . 1000 megohms Min. @ 500VDC

# Series F Ferrite Filtered Connectors

## Pin Contact – Right Angle Mount



| Part Number  | Description     | Typ. Impedance (Ohms) |         | Frequency Range               | A +/-            | B +/-            | C +/-            | D +/-           | E +/-            | F +/-            | G +/-           | H +/-            | I +/-            | J +/-            |
|--------------|-----------------|-----------------------|---------|-------------------------------|------------------|------------------|------------------|-----------------|------------------|------------------|-----------------|------------------|------------------|------------------|
|              |                 | 30 MHz                | 100 MHz |                               | 0.010<br>(0.25)  | 0.005<br>(0.13)  | 0.015<br>(0.38)  | 0.010<br>(0.25) | 0.015<br>(0.38)  | 0.005<br>(0.13)  | 0.004<br>(0.10) | 0.005<br>(0.13)  | 0.005<br>(0.13)  | 0.005<br>(0.13)  |
| € 56-402-001 | D-Sub<br>9 pin  | 20                    | 27      | 10<br>MHz<br>to<br>300<br>MHz | 0.666<br>(16.92) | 0.984<br>(25.00) | 1.213<br>(30.81) | 0.318<br>(8.08) | 0.751<br>(19.10) | 0.324<br>(8.22)  | 0.108<br>(2.74) | 0.984<br>(25.00) | 0.432<br>(10.98) | 0.606<br>(15.40) |
| € 56-412-001 | D-Sub<br>15 pin |                       |         |                               | 0.994<br>(25.25) | 1.312<br>(33.32) | 1.541<br>(39.14) | 0.318<br>(8.08) | 0.751<br>(19.10) | 0.648<br>(16.46) | 0.108<br>(2.74) | 1.312<br>(33.32) | 0.756<br>(19.20) | 0.929<br>(23.60) |
| € 56-422-001 | D-Sub<br>25 pin |                       |         |                               | 1.534<br>(38.96) | 1.852<br>(47.04) | 2.088<br>(53.04) | 0.318<br>(8.08) | 0.751<br>(19.10) | 1.196<br>(30.36) | 0.110<br>(2.76) | 1.852<br>(47.04) | 1.304<br>(31.12) | 1.476<br>(37.50) |

€ Also available through API's authorized European distributors/agents.

Dimensions in inches (mm)

# Series F Ferrite Filtered Connectors

## Socket Contact – Right Angle Mount

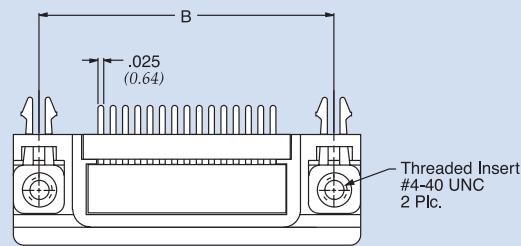
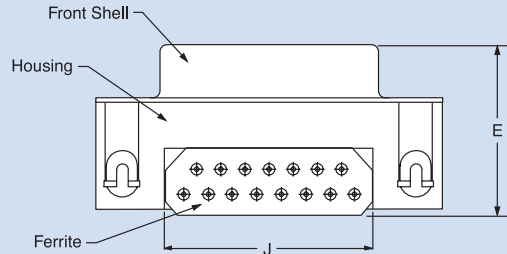
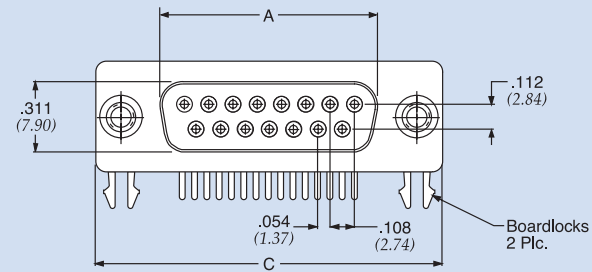

## \*High-Density



| Part Number     | Description          | Typ. Impedance (Ohms) |         | Frequency Range   | A +/-         | B +/-         | C +/-         | D +/-               | E +/-         | F +/-         | G +/-        | H +/-         | I +/-         | J +/-         |
|-----------------|----------------------|-----------------------|---------|-------------------|---------------|---------------|---------------|---------------------|---------------|---------------|--------------|---------------|---------------|---------------|
|                 |                      | 30 MHz                | 100 MHz |                   | 0.010         | 0.005         | 0.015         | 0.010               | 0.015         | 0.005         | 0.004        | 0.005         | 0.005         | 0.005         |
| € 56-404-001    | D-Sub 9 socket       | 20                    | 27      | 10 MHz to 300 MHz | 0.643 (16.33) | 0.984 (25.00) | 1.213 (30.81) | 0.318 (8.08)        | 0.755 (19.20) | 0.324 (8.22)  | 0.108 (2.74) | 0.984 (25.00) | 0.432 (10.98) | 0.606 (15.40) |
| € 56-414-001    | D-Sub 15 socket      |                       |         |                   | 0.971 (24.66) | 1.312 (33.32) | 1.541 (39.14) | 0.318 (8.08)        | 0.755 (19.20) | 0.648 (16.46) | 0.108 (2.74) | 1.312 (33.32) | 0.756 (19.20) | 0.929 (23.60) |
| € 56-424-001    | D-Sub 25 socket      |                       |         |                   | 1.511 (38.38) | 1.852 (47.04) | 2.088 (53.04) | 0.318 (8.08)        | 0.755 (19.20) | 1.196 (30.36) | 0.110 (2.76) | 1.852 (47.04) | 1.304 (31.12) | 1.476 (37.50) |
| € 56-414-001-HD | Hi-Density 15 socket | 16                    | 26      |                   | 0.643 (16.33) | 0.984 (25.00) | 1.213 (30.81) | * See inset drawing |               |               |              |               |               |               |

€ Also available through API's authorized European distributors/agents.

Dimensions in inches (mm)

# Series F Ferrite Filtered Connectors

## Pin Contact – Vertical Mount



| Part Number | Description  | Typ. Impedance (Ohms) |         | Frequency Range   | A +/-            | B +/-            | C +/-            | D +/-           | E +/-            | F +/-            | G +/-           | H +/-            | I +/-            |
|-------------|--------------|-----------------------|---------|-------------------|------------------|------------------|------------------|-----------------|------------------|------------------|-----------------|------------------|------------------|
|             |              | 30 MHz                | 100 MHz |                   | 0.010<br>(0.25)  | 0.005<br>(0.13)  | 0.015<br>(0.38)  | 0.010<br>(0.25) | 0.015<br>(0.38)  | 0.005<br>(0.13)  | 0.004<br>(0.10) | 0.005<br>(0.13)  | 0.005<br>(0.13)  |
| 56-407-001  | D-Sub 9 pin  | 10                    | 15      | 10 MHz to 300 MHz | 0.666<br>(16.92) | 0.984<br>(25.00) | 1.213<br>(30.81) | 0.236<br>(5.99) | 0.468<br>(11.88) | 0.324<br>(8.22)  | 0.108<br>(2.74) | 0.984<br>(25.00) | 0.432<br>(10.98) |
| 56-417-001  | D-Sub 15 pin |                       |         |                   | .994<br>(25.25)  | 1.312<br>(33.32) | 1.541<br>(39.14) | 0.236<br>(5.99) | 0.468<br>(11.88) | 0.648<br>(16.46) | 0.108<br>(2.74) | 1.312<br>(33.32) | 0.756<br>(19.20) |
| 56-427-001  | D-Sub 25 pin |                       |         |                   | 1.534<br>(38.96) | 1.852<br>(47.04) | 2.088<br>(53.04) | 0.236<br>(5.99) | 0.468<br>(11.88) | 1.196<br>(30.36) | 0.110<br>(2.76) | 1.852<br>(47.04) | 1.304<br>(31.12) |

Dimensions in inches (mm)

# Series F Ferrite Filtered Connectors

## Socket Contact – Vertical Mount



| Part Number | Description     | Typ. Impedance (Ohms) |         | Frequency Range   | A +/-            | B +/-            | C +/-            | D +/-           | E +/-            | F +/-            | G +/-           | H +/-            | I +/-            |
|-------------|-----------------|-----------------------|---------|-------------------|------------------|------------------|------------------|-----------------|------------------|------------------|-----------------|------------------|------------------|
|             |                 | 30 MHz                | 100 MHz |                   | 0.010<br>(0.25)  | 0.005<br>(0.13)  | 0.015<br>(0.38)  | 0.010<br>(0.25) | 0.015<br>(0.38)  | 0.005<br>(0.13)  | 0.004<br>(0.10) | 0.005<br>(0.13)  | 0.005<br>(0.13)  |
| 56-403-001  | D-Sub 9 socket  | 10                    | 15      | 10 MHz to 300 MHz | 0.643<br>(16.33) | 0.984<br>(25.00) | 1.213<br>(30.81) | 0.236<br>(5.99) | 0.472<br>(11.98) | 0.324<br>(8.22)  | 0.108<br>(2.74) | 0.984<br>(25.00) | 0.432<br>(10.98) |
| 56-413-001  | D-Sub 15 socket |                       |         |                   | .971<br>(24.66)  | 1.312<br>(33.32) | 1.541<br>(39.14) | 0.236<br>(5.99) | 0.472<br>(11.98) | 0.648<br>(16.46) | 0.108<br>(2.74) | 1.312<br>(33.32) | 0.756<br>(19.20) |
| 56-423-001  | D-Sub 25 socket |                       |         |                   | 1.511<br>(38.38) | 1.852<br>(47.04) | 2.088<br>(53.04) | 0.236<br>(5.99) | 0.472<br>(11.98) | 1.196<br>(30.36) | 0.110<br>(2.76) | 1.852<br>(47.04) | 1.304<br>(31.12) |

Dimensions in inches (mm)

## Series 500 Low Profile Filtered Connectors

API's Spectrum Control brand of Series 500 are cost effective, highly reliable EMI filtered D-subminiature connectors that feature a .318" footprint for 90 degree PCB connectors and a low profile housing for straight PCB connectors. Series 500 filtered D-sub are "drop-in" replacements for standard unfiltered D-sub connectors.

The ability of these connectors to achieve EMI filtering within the smaller footprint is the result of technical advances in ceramic capacitors. Series 500 connectors use tubular capacitors for high performance EMI filtering. Quality features for these connectors include board lock mounting, metal front shells and gold plated contacts.

Series 500 capacitive filtered D-sub connectors are an ideal solution to FCC/EC/VCCI emissions problems. These connectors are designed to protect equipment from external EMI noise and eliminate system glitches.

### Series 500 Applications

- Personal computers
- Industrial process equipment
- Graphics workstations
- PBX telecommunications equipment
- Cellular base stations and medical electronics



### Features

- "Drop-in" replacements for unfiltered D-subminiatures
- Compact design, featuring .318" footprint
- Tubular feed-through capacitors provide filtering superior to on-board components
- Ground plane design provides EMI shielding
- Full interchangeability; based on MIL-C-24308
- Each connector position is tested 100% for critical electrical parameters to ensure consistent performance
- Insulators are UL recognized UL94-V0 flammability rated
- 9, 15 and 25 shell sizes
- Available with board lock feature and 4-40 mounting threads
- Selective filtering available
- UL/CSA approved
- Greater than 40 dB filtering up through 1 GHz without resonances
- Bi-directional control of EMI at the I/O ports





# Series 500 Low Profile Filtered Connectors



## Mechanical Specifications

- Shell . . . . . Steel, tin plated
- Insulators . . . . . Glass-filled polyester, flammability UL94V-O
- Pin Contacts . . . . . Copper alloy CA725, 15 microinch (0.38  $\mu\text{m}$ ) gold plated\* over nickel
- Socket Contacts . . . . . Copper alloy CA725, 30 microinch (0.76  $\mu\text{m}$ ) gold plated\* over nickel
- \*Heavier gold plating available upon request.
- Ground Plane . . . . . Phosphor bronze, nickel plated
- Operating Temperature . . . . . -40°C to +125°C
- Capacitors . . . . . Proprietary barium titanate ceramic formulations

Other environmental tests such as shock, vibration, humidity, etc. are performed as detailed in our filtered connector performance specifications on page FC81.

## Electrical Specifications

- Current Rating . . . . . 5 Amps
- RF Current Rating . . . . . 0.3 Amps
- Contact Resistance . . . . . 10 milliohms maximum
- Capacitance . . . . . 120, 440, 840, 1000, 1500 pF  $\pm 30\%$
- Working Voltage . . . . . 100 VDC
- Dielectric Withstanding Voltage . . . . . 300 VDC
- Insulation Resistance . . . . . 1 Gohm minimum
- UL Recognized . . . . . Under category of communication circuit accessories, File #E149046



840 pF is typically within 2 dB of 1000 pF curve.

## Filter Performance

| Cap. (pF) Value $\pm 30\%$ | 3 dB Cut-off Freq. (MHz) | Insertion Loss (dB) |         |         |       |       |       |
|----------------------------|--------------------------|---------------------|---------|---------|-------|-------|-------|
|                            |                          | 20 MHz              | 100 MHz | 500 MHz | 1 GHz | 2 GHz | 5 GHz |
| 120                        | 40                       | –                   | 4       | 21      | 26    | 26    | 20    |
| 440                        | 11                       | 3                   | 15      | 27      | 33    | 32    | 25    |
| 840                        | 6                        | 6                   | 19      | 32      | 38    | 37    | 25    |
| 1000                       | 3                        | 8                   | 21      | 35      | 41    | 38    | 25    |
| 1500                       | 2                        | 10                  | 25      | 40      | 47    | 42    | 25    |

Insertion loss measured per MIL-STD-220, no load, 50 ohm source and load. Above data represents guaranteed minimum.

# Series 500 Low Profile Filtered Connectors

## Pin Contact (*plug*) Straight PC Mount



## 90° PC Mount



| Size | A                | B                | C                | D                | E                |
|------|------------------|------------------|------------------|------------------|------------------|
| 9    | 1.213<br>(30.81) | 0.984<br>(24.99) | 0.666<br>(16.92) | 0.540<br>(13.72) | 0.748<br>(19.00) |
| 15   | 1.541<br>(39.14) | 1.312<br>(33.32) | 0.994<br>(25.25) | 0.867<br>(22.02) | 1.076<br>(27.33) |
| 25   | 2.088<br>(53.04) | 1.852<br>(47.04) | 1.534<br>(38.96) | 1.412<br>(35.86) | 1.616<br>(41.05) |

Standard Tolerance = ±.015 (0.38)

Dimensions in inches (mm)

## Socket Contact (*receptacle*) Straight PC Mount



## 90° PC Mount



| Size | A                | B                | C                | D                | E                |
|------|------------------|------------------|------------------|------------------|------------------|
| 9    | 1.213<br>(30.81) | 0.984<br>(24.99) | 0.642<br>(16.31) | 0.540<br>(13.72) | 0.748<br>(19.00) |
| 15   | 1.541<br>(39.14) | 1.312<br>(33.32) | 0.970<br>(24.64) | 0.867<br>(22.02) | 1.076<br>(27.33) |
| 25   | 2.088<br>(53.04) | 1.852<br>(47.04) | 1.510<br>(38.35) | 1.412<br>(35.86) | 1.616<br>(41.05) |

Standard Tolerance = ±.015 (0.38)

Dimensions in inches (mm)

# Series 500 Low Profile Filtered Connectors

## Ordering Information

Example: **56-524-013-GBL**



This part number represents a Series 500 filtered D-sub connector with 25 contacts, socket to 90° PCB mount configuration. The filter has a capacitance value of 1000 pF and the connector includes a grounded board lock.

For special needs or combinations of features, contact API engineering.

**Capacitance Value**  
**010** - 120 pF  
**011** - 440 pF  
**012** - 840 pF  
**013** - 1000 pF  
**014** - 1500 pF

### Mounting or Hardware Options

**TI** - 4-40 threads on mounting flange (.120" (3.05mm) hole if not selected)  
**GBL** - Grounded board lock, includes 4-40 threads (available only on 90° PCB)  
**GBLF** - Grounded board lock and ferrite slab, provides the enhanced performance of an (LC) filter (available only on 90° PCB)

## GBL Option

**Features**

- Snap-in retention to PC board, requires no hardware
- Ensures low ground impedance for superior filtering
- 4-40 threads on mounting flange eliminate loose hardware

Dimensions in inches (mm)

## Board Layout

| Typical Layout for .318" (8.08) Footprint |           | Shell Size       | A  | B  | C               | D |
|---|-----------|------------------|--|--|-----------------|---|
|   | <b>9</b>  | .984<br>(24.99)  | .436 = 4 x .109<br>(11.07 = 4 x 2.77)    | .327 = 3 x .109<br>(8.31 = 3 x 2.77)     | .492<br>(12.50) |   |
|   | <b>15</b> | 1.312<br>(33.32) | .763 = 7 x .109<br>(19.38 = 7 x 2.77)    | .654 = 6 x .109<br>(16.61 = 6 x 2.77)    | .656<br>(16.66) |   |
|   | <b>25</b> | 1.852<br>(47.04) | 1.308 = 12 x .109<br>(33.22 = 12 x 2.77) | 1.199 = 11 x .109<br>(30.45 = 11 x 2.77) | .926<br>(23.52) |   |

Dimensions in inches (mm)

# Series 600 High-Density Filtered Connectors

The miniaturization of electronic systems and sub-systems is pushing designers to increase circuit densities within smaller packages. To address this growing need, API Technologies' Spectrum Control brand has developed a line of filtered High-Density D-subminiature connectors. This new line of connectors incorporates the high performance and reliable filtering of API's standard D-sub in the High-Density format.

## Features

- Connectors designed to MIL-C-24308
- Capacitance values from 85 pF to 4000 pF
- Filter type feed-through C
- Selectively specify and filter each contact position
- Available in feed-through capacitive configurations

## Mechanical Specifications:

Same as Series 700 connectors, page FC21.

## Typical Insertion Loss

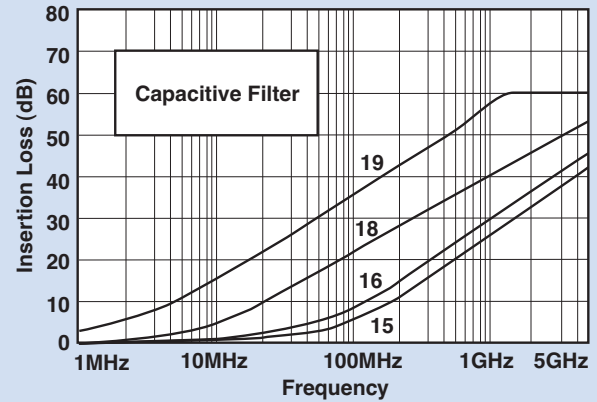

Above curves represent application of proper grounding fundamentals, for assistance consult with Spectrum Control.

Insertion loss measured per MIL-STD-220, no load, 50 ohm source and load.

## Electrical Specifications

Current Rating . . . . 3 Amps

RF Current Rating . . 0.3 Amps

Contact Resistance . . 15 milliohms maximum

UL Recognized . . . . Under category of communication circuit accessories, File #E149046

## Electrical Specifications: High-Density Connectors

| Filter Designations | Filter Circuits | Capacitance |      | 3 dB Cut-off Frequency Max. (MHz) | Dielectric With-standing Voltage | Working Voltage DC -55°C to +125°C | Minimum Insertion Loss - Decibels (dB) |        |        |        |         |         |         |       |       |       |
|---------------------|-----------------|-------------|------|-----------------------------------|----------------------------------|------------------------------------|--|--------|--------|--------|---------|---------|---------|-------|-------|-------|
|                     |                 | Value       | Tol. |                                   |                                  |                                    | 5 MHz                                  | 10 MHz | 20 MHz | 50 MHz | 100 MHz | 200 MHz | 500 MHz | 1 GHz | 2 GHz | 5 GHz |
| 15                  | C               | 85 pF       | ±25% | 60                                | 300V                             | 100V                               | —                                      | —      | —      | —      | 1       | 6       | 16      | 21    | 22    | 20    |
| 16                  |                 | 180 pF      | ±25% | 28                                | 300V                             | 100V                               | —                                      | —      | —      | 1      | 8       | 10      | 18      | 25    | 26    | 24    |
| 18                  |                 | 1000 pF     | ±25% | 5.1                               | 300V                             | 100V                               | —                                      | 3      | 8      | 14     | 20      | 25      | 32      | 35    | 41    | 39    |
| 19                  |                 | 4000 pF     | ±25% | 1.3                               | 300V                             | 100V                               | 8                                      | 13     | 19     | 26     | 31      | 37      | 45      | 48    | 52    | 47    |

Filter designation "G" for grounded contacts, "I" for insulated (not filtered) contacts. Filter designation "O" for omitted contact and no hole in ground plane.

Above data represents guaranteed minimum.

## Ordering Information

Example: 56-605-015-LI

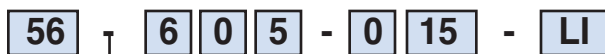

D-Sub Connector  
Hi-Density

### Shell Size\*\*

- 0 = 15
- 1 = 26
- 2 = 44
- 3 = 62
- 4 = 78

- Standard connector  
F - RoHS compliant version

### Contact/Termination

- 1 - Pin to solder cup
- 2 - Pin to 90° PCB mount\*
- 3 - Socket to PCB mount
- 4 - Socket to 90° PCB\* mount
- 5 - Pin-socket adapter
- 7 - Pin to PCB mount

### Special

- 0 = All positions same
- 9 = Special loading

\*\* Some shell sizes require minimum order quantity. Consult API for details.

This part number represents a Series 600 Hi-Density filtered D-Sub connector with 15 contacts, pin-socket adapter configuration. The FT filters have a capacitance value of 85 pF and the connector includes 4-40 locking inserts.

### Filter Designation

- 15 - 85 pF FT
- 16 - 180 pF FT
- 18 - 1,000 pF FT
- 19 - 4,000 pF FT
- 20 - Insulated contact

### Options

- LI = 4-40 inserts
- S = Solder dip tails
- 50G =  $\mu$  gold
- GBL = Grounding board lock

\* Required on right angle parts

Note: VGA adapters also available. Consult factory

# Series 600 High-Density Filtered Connectors



## Pin/Socket Adapter

| Size | A                | B                | C                | D               | E               | F                | G               |
|------|------------------|------------------|------------------|-----------------|-----------------|------------------|-----------------|
| 15   | 1.213<br>(30.81) | .984<br>(24.99)  | .640<br>(16.26)  | .304<br>(7.72)  | .505<br>(12.83) | .666<br>(16.92)  | .333<br>(8.46)  |
| 26   | 1.541<br>(39.14) | 1.312<br>(33.32) | .968<br>(24.59)  | .304<br>(7.72)  | .505<br>(12.83) | .994<br>(25.25)  | .333<br>(8.46)  |
| 44   | 2.088<br>(53.04) | 1.852<br>(47.04) | 1.508<br>(38.30) | .304<br>(7.72)  | .505<br>(12.83) | 1.534<br>(38.96) | .333<br>(8.46)  |
| 62   | 2.729<br>(69.32) | 2.500<br>(63.50) | 2.156<br>(54.76) | .304<br>(7.72)  | .505<br>(12.83) | 2.182<br>(55.42) | .333<br>(8.46)  |
| 78   | 2.635<br>(66.93) | 2.406<br>(61.11) | 2.062<br>(52.37) | .416<br>(10.57) | .615<br>(15.62) | 2.079<br>(52.81) | .420<br>(11.18) |



## Pin or Socket to Solder Cup, PCB Mount and 90° PCB Mount

| Size | A                | B                | C               | D                | E               | F                | G               |
|------|------------------|------------------|-----------------|------------------|-----------------|------------------|-----------------|
| 15   | 1.213<br>(30.81) | .984<br>(24.99)  | .505<br>(12.83) | .666<br>(16.92)  | .333<br>(8.46)  | .757<br>(19.23)  | .420<br>(10.67) |
| 26   | 1.541<br>(39.14) | 1.312<br>(33.32) | .505<br>(12.83) | .994<br>(25.25)  | .333<br>(8.46)  | 1.085<br>(27.56) | .420<br>(10.67) |
| 44   | 2.088<br>(53.04) | 1.852<br>(47.04) | .505<br>(12.83) | 1.534<br>(38.96) | .333<br>(8.46)  | 1.625<br>(41.28) | .420<br>(10.67) |
| 62   | 2.729<br>(69.32) | 2.500<br>(63.50) | .505<br>(12.83) | 2.182<br>(55.42) | .333<br>(8.46)  | 2.273<br>(57.73) | .420<br>(10.67) |
| 78   | 2.635<br>(66.93) | 2.406<br>(61.11) | .615<br>(15.62) | 2.079<br>(52.81) | .440<br>(11.18) | 2.170<br>(55.12) | .527<br>(13.39) |



Dimensions in inches (mm)

# High-Density Filtered Adapter for Telecommunications



Within the telecommunications industry, it has been standard practice to use an adapter (male/female) type of EMI filtered system connector as the interface between the switching system electronics and the premise wiring. These filtered adapters provide effective containment of EMI compared to either D-subminiature or 50-position “ribbon” contact type connectors.

The following several factors have mandated the development of a new generation of filtered adapters.

## Special Requirements

- Higher density wiring
- The need for more contacts, usually a multiple of 16
- Higher reliability contact geometries
- Bellcore TR-NWT-001089 requirements
  - 1000 volts AC withstand for one minute
  - 2500 volts spike surge testing
- Improved flammable resistant plastic insulators

API’s Spectrum Control brand, in response to these unique requirements of the telecommunication industry, has developed a new high-density filtered adapter.

## Features

- New ceramic technology and filter element construction to accept higher voltages
- Improved reliability compared to “ribbon” type connectors
- Integral ground plane and one-piece diecast housing for the highest level of EMI integrity
- More contacts/wires per square inch of panel space through high-density arrangements
- 64 contact positions standard, with 78 positions available by request in any filter combination

## Mechanical Specifications

- Shell* . . . . . Zinc or aluminum diecast, nickel plated 150  $\mu$  inches (3.81  $\mu$ m) min.
- Insulators* . . . . . Thermoplastic, UL94V-0
- Contacts* . . . . . One-piece, screw machined Copper alloy, contact area plated 50  $\mu$  inches (1.27  $\mu$ m) gold over 50  $\mu$  inches (1.27  $\mu$ m) nickel
- Ground Plane* . . . . . Brass, solder plated
- Grounding Springs* . . . . . Beryllium copper, tin plated per MIL-T-10727
- Operating Temperature* . . . . . -55°C to +125°C
- Capacitor* . . . . . High performance ceramic feed-through utilizing ultra low ESR design

## Electrical Specifications

- Rated Voltage* . . . . . 100 VDC
- Current Rating* . . . . . 3 Amps
- DC Resistance* . . . . . 15 milliohm max.
- Dielectric Withstanding Voltage* . . . . . 1000 VRMS (FCC Part 68 test)
- Capacitance* . . . . . 1000 pF,  $\pm$ 25%
- Voltage Surge* . . . . . meets 2500 volts surge (10/1000) (See Wave form figure on next page)

# High-Density Filtered Adapter for Telecommunications

## Filter Performance

| Minimum Insertion Loss |       |
|------------------------|-------|
| 20 MHz                 | 7 dB  |
| 50 MHz                 | 14 dB |
| 100 MHz                | 20 dB |
| 500 MHz                | 32 dB |
| 1 GHz                  | 35 dB |
| 2 GHz                  | 41 dB |
| 5 GHz                  | 39 dB |

Insertion loss measured per MIL-STD-220, no load, 50 ohm source and load. Above data represents guaranteed minimum.

## Part Number for Ordering: #56-645-002



Dimensions in inches (mm)

## Typical Insertion Loss



Above curves represent application of proper grounding fundamentals, for assistance consult with API.

## Pulse Wave Form\* (10 x 1000)



\* Reference Bellcore TR-NWT-1089, V<sub>pp</sub> = 1000V

# Series 700 High Performance Filtered Connectors

## Filter Selection

API's Spectrum Control brand of Series 700 connectors offer the highest performance filtering for all types of professional applications.

## Features

- Available in 9, 15, 25, 37 and 50 shell sizes
- Variety of termination configurations including right angle and straight PCB for both pin and socket contact and as an adapter
- Capacitive and Pi type filters in a full range of capacitance values

The catalog data for this series is presented in order of shell size, and grouped by pin and socket contacts. Part numbers must be selected from the tables within the series section.

## Typical Insertion Loss



Above curves represent application of proper grounding fundamentals, for assistance consult with API.

*Insertion loss measured per MIL-STD-220, no load, 50ohm source and load.*

## Electrical Specifications: High Performance Connectors

| Filter Designations | Filter Circuits | Capacitance |          | 3 dB Cut-off Frequency Max. (MHz) | Dielectric With-standing Voltage | Working Voltage DC -55°C to +125°C | Minimum Insertion Loss - Decibels (dB) |        |        |        |         |         |         |       |       |       |
|---------------------|-----------------|-------------|----------|-----------------------------------|----------------------------------|------------------------------------|--|--------|--------|--------|---------|---------|---------|-------|-------|-------|
|                     |                 | Value       | Tol.     |                                   |                                  |                                    | 5 MHz                                  | 10 MHz | 20 MHz | 50 MHz | 100 MHz | 200 MHz | 500 MHz | 1 GHz | 2 GHz | 5 GHz |
| J                   | Pi              | 100 pF      | +100 -0% | 32                                | 300V                             | 100V                               | —                                      | —      | —      | 2      | 6       | 11      | 27      | 40    | 43    | 40    |
| A                   |                 | 310 pF      | ±20%     | 17                                | 300V                             | 100V                               | —                                      | —      | 3      | 7      | 13      | 21      | 36      | 43    | 50    | 45    |
| C                   |                 | 1000 pF     | +150 -0% | 3.2                               | 300V                             | 100V                               | —                                      | 5      | 9      | 19     | 30      | 43      | 62      | 70    | 68    | 63    |
| K                   |                 | 2500 pF     | +100 -0% | 1.3                               | 150V                             | 50V                                | 8                                      | 13     | 18     | 33     | 45      | 58      | 73      | 78    | 70    | 65    |
| E                   |                 | 4000 pF     | +100 -0% | 0.8                               | 150V                             | 50V                                | 8                                      | 13     | 20     | 35     | 48      | 61      | 76      | 80    | 70    | 65    |
| N                   | C               | 375 pF      | ±20%     | 14                                | 600V                             | 200V                               | —                                      | —      | 2      | 7      | 13      | 20      | 29      | 35    | 30    | 29    |
| L                   |                 | 500 pF      | ±20%     | 10.6                              | 600V                             | 200V                               | —                                      | —      | 3      | 10     | 15      | 22      | 31      | 37    | 33    | 31    |
| F                   |                 | 830 pF      | ±20%     | 6.4                               | 600V                             | 200V                               | —                                      | 4      | 9      | 16     | 22      | 28      | 35      | 39    | 38    | 36    |
| B                   |                 | 1000 pF     | +100 -0% | 3.2                               | 600V                             | 200V                               | —                                      | 5      | 10     | 17     | 23      | 30      | 37      | 43    | 44    | 42    |
| D                   |                 | 5000 pF     | +100 -0% | 0.64                              | 300V                             | 100V                               | 10                                     | 16     | 22     | 30     | 35      | 41      | 50      | 52    | 52    | 50    |

Filter designation "G" for grounded contacts, "I" for insulated (not filtered) contacts. Filter designation "O" for omitted contact and no hole in ground plane.

*Above data represents guaranteed minimum.*



# Series 700 Specifications and Connector Ordering

## Mechanical Specifications

- Shell* . . . . . Zinc or aluminum diecast, nickel plated  
 150  $\mu$  inches (3.81  $\mu$ m) min.
- Insulators* . . . . . Glass-filled polyester,  
 flammability UL94V-0
- Pin Contacts* . . . . . Copper alloy, 15  $\mu$  inches  
 (0.38  $\mu$ m) gold plated \* over nickel
- Socket Contacts* . . . . . Copper alloy, 30  $\mu$  inches  
 (0.76  $\mu$ m) gold plated \* over nickel  
 \* Heavier gold plating available upon request.  
 See pg. FC43: Connector Options
- Terminations* . . . . . Gold flash for PCB mount and solder  
 cups. Solder dipped also available.
- Ground Plane* . . . . . Brass, solder plated
- Grounding  
 Springs* . . . . . Beryllium copper, tin plated per  
 MIL-T-10727
- Operating  
 Temperature* . . . . . -55°C to +125°C
- Capacitors* . . . . . Proprietary barium titanate  
 ceramic formulations

## Electrical Specifications

- Current Rating* . . . . . 5 Amps
  - R.F. Current  
 Rating* . . . . . 0.3 Amps
  - Contact  
 Resistance* . . . . . 10 milliohms maximum
  - UL Recognized* . . . . . Under category of communication  
 circuit accessories, File #E149046
  - Inductance on  
 PI Filters* . . . . . ~ 860 nH between 100 kHz and 1 MHz
- Solder cups accept up to a 20 gauge wire.

**Note:**  
 For additional mechanical, electrical, and  
 environmental specifications, refer to page FC79.

## Ordering Your Connector

### STEP 1: SELECTING THE FILTER

- Using the insert loss graphs on page FC20 determine which filters provide the required attenuation at the troublesome frequency, while not affecting the signal frequency by more than 3 to 6 dB.
- Choose the filter type, either feed-through capacitor or Pi. The Pi is generally considered better due to its superior high frequency performance and steeper curve. The feed-through capacitor is lower cost.
- Select capacitance value.
- Note the Spectrum letter designation for the filter chosen from the table on page FC20.

### STEP 2: SELECTING THE CONNECTOR

- Turn to the appropriate size section.  
 (9, 15, 25, 37, 50)
- Choose either pin contacts (plug) or socket contacts (receptacle).
- Choose the required termination type.
- From the table on the appropriate connector page, using the filter letter designation chosen in step 1 above, select the part number.

### STEP 3: SPECIFYING OPTIONS

- Refer to page FC43 for special options including heavy gold plating, 4-40 mounting threads, grounding brackets, hardware, and others.
- Most options are available within the standard lead times.
- Some options require a part number suffix, while other combinations may require factory assistance for part number assignment. If a suffix is shown, add it to your selected part number. If more than one option is needed, consult with factory for part number assignment.

**9** Series 700  
Shell Size Pin Contact



**Printed Circuit Board Mount**

| Spectrum Part Number | EMI Filter           |            |
|----------------------|----------------------|------------|
|                      | Filter Designation** | Cap. Value |
| 56-701-001           | A                    | 310 pF Pi  |
| 56-701-002           | B                    | 1000 pF C  |
| 56-701-003           | C                    | 1000 pF Pi |
| 56-701-004           | D                    | 5000 pF C  |
| 56-701-005           | E                    | 4000 pF Pi |
| 56-701-028           | F                    | 830 pF C   |
| 56-701-029           | J                    | 100 pF Pi  |
| 56-701-030           | K                    | 2500 pF Pi |
| 56-701-047           | N                    | 375 pF C   |
| 56-701-086           | L                    | 500 pF C   |

**Mating Face**  
 .666 (16.92) x 1.213 (30.81) x .494 (12.55)  
 .984 (24.99) x .329 (8.36)

**Termination Face**  
 .120 ± .005 DIA. HOLES (3.05 ± 0.13 DIA. HOLES)  
 .757 (19.23) x .420 (10.67) x 10°

**Side View**  
 .050 (1.27) x .238 (6.05) x .150 (3.81) ± .025 SQ. (.64 SQ.)  
 .408 (10.36) ± .020

**Printed Circuit Board Right Angle Mount**

| Spectrum Part Number | EMI Filter           |            |
|----------------------|----------------------|------------|
|                      | Filter Designation** | Cap. Value |
| * 56-702-001         | A                    | 310 pF Pi  |
| 56-702-002           | B                    | 1000 pF C  |
| * 56-702-003         | C                    | 1000 pF Pi |
| 56-702-004           | D                    | 5000 pF C  |
| * 56-702-005         | E                    | 4000 pF Pi |
| 56-702-007           | F                    | 830 pF C   |
| 56-702-008           | J                    | 100 pF Pi  |
| 56-702-009           | K                    | 2500 pF Pi |
| 56-702-013           | N                    | 375 pF C   |
| * 56-702-033         | L                    | 500 pF C   |

**Mating Face**  
 .666 (16.92) x 1.213 (30.81) x .494 (12.55)  
 .984 (24.99) x .329 (8.36)

**Termination Face**  
 .120 ± .005 DIA. HOLES (3.05 ± 0.13 DIA. HOLES)  
 .757 (19.23) x .420 (10.67) x 10°

**Bottom View**  
 .125 ± .005 DIA. HOLES (3.18 ± 0.13 DIA. HOLES)  
 .12R (3.05R) x .618 (15.70) x .540 (13.72) ± .025 SQ. (.64 SQ.)  
 .290 (7.37) x .275 (6.99) x .740 (18.80) ± .020

**Side View**  
 .105 (2.67) ± .025 SQ. (.64 SQ.)  
 .590 (14.99) ± .020 x .702 (17.83) ± .020

\* May be available from distributor stock.  
 \*\* See page FC20 for filter performance.  
 Standard Tolerance = ±.005 except where noted, ± = ±.015

Dimensions in inches (mm)

# 9 Series 700 Shell Size Pin Contact



## Solderless Wire Wrap

| Spectrum Part Number<br><i>Select one</i> | EMI Filter |           |           | Filter<br>Desig.** | Cap. Value |
|---|------------|-----------|-----------|--------------------|------------|
|   | L<br>.500  | L<br>.375 | L<br>.250 |                    |            |
| 56-701 -006 -022 -017                     |            |           |           | A                  | 310 pF Pi  |
| 56-701 -007 -023 -018                     |            |           |           | B                  | 1000 pF C  |
| 56-701 -008 -024 -019                     |            |           |           | C                  | 1000 pF Pi |
| 56-701 -009 -025 -020                     |            |           |           | D                  | 5000 pF C  |
| 56-701 -010 -026 -021                     |            |           |           | E                  | 4000 pF Pi |
| 56-701 -037 -034 -031                     |            |           |           | F                  | 830 pF C   |
| 56-701 -038 -035 -032                     |            |           |           | J                  | 100 pF Pi  |
| 56-701 -039 -036 -033                     |            |           |           | K                  | 2500 pF Pi |
| 56-701 -050 -049 -048                     |            |           |           | N                  | 375 pF C   |



## Solder Cup Termination

| Spectrum Part Number | EMI Filter           |            |
|----------------------|----------------------|------------|
|                      | Filter Designation** | Cap. Value |
| * 56-701-011         | A                    | 310 pF Pi  |
| * 56-701-012         | B                    | 1000 pF C  |
| * 56-701-013         | C                    | 1000 pF Pi |
| * 56-701-014         | D                    | 5000 pF C  |
| * 56-701-015         | E                    | 4000 pF Pi |
| * 56-701-040         | F                    | 830 pF C   |
| 56-701-041           | J                    | 100 pF Pi  |
| 56-701-042           | K                    | 2500 pF Pi |
| 56-701-081           | N                    | 375 pF C   |
| 56-701-087           | L                    | 500 pF C   |



\* May be available from distributor stock.  
 \*\* See page FC20 for filter performance.  
 Standard Tolerance = ±.005 except where noted, ∅ = ±.015

Dimensions in inches (mm)

# 9 Series 700 Shell Size Socket Contact



## Printed Circuit Board Mount

| Spectrum Part Number | EMI Filter           |            |
|----------------------|----------------------|------------|
|                      | Filter Designation** | Cap. Value |
| 56-703-001           | A                    | 310 pF Pi  |
| 56-703-002           | B                    | 1000 pF C  |
| 56-703-003           | C                    | 1000 pF Pi |
| 56-703-004           | D                    | 5000 pF C  |
| 56-703-005           | E                    | 4000 pF Pi |
| 56-703-022           | F                    | 830 pF C   |
| 56-703-023           | J                    | 100 pF Pi  |
| 56-703-024           | K                    | 2500 pF Pi |
| 56-703-036           | N                    | 375 pF C   |
| 56-703-047           | L                    | 500 pF C   |

## Printed Circuit Board Right Angle Mount

| Spectrum Part Number | EMI Filter           |            |
|----------------------|----------------------|------------|
|                      | Filter Designation** | Cap. Value |
| 56-704-001           | A                    | 310 pF Pi  |
| 56-704-002           | B                    | 1000 pF C  |
| * 56-704-003         | C                    | 1000 pF Pi |
| 56-704-004           | D                    | 5000 pF C  |
| * 56-704-005         | E                    | 4000 pF Pi |
| 56-704-007           | F                    | 830 pF C   |
| 56-704-008           | J                    | 100 pF Pi  |
| 56-704-009           | K                    | 2500 pF Pi |
| 56-704-018           | N                    | 375 pF C   |
| 56-704-035           | L                    | 500 pF C   |

\* May be available from distributor stock.

\*\* See page FC20 for filter performance.

Standard Tolerance = ±.005 except where noted, ∅ = ±.015

Dimensions in inches (mm)

# 9 Series 700 Shell Size Socket Contact & Pin/Socket Adapter



## Solderless Wire Wrap

| Spectrum Part Number<br><i>Select one</i> | EMI Filter |           |           |                 |            |
|---|------------|-----------|-----------|-----------------|------------|
|   | L<br>.500  | L<br>.375 | L<br>.250 | Filter Desig.** | Cap. Value |
| 56-703 -006                               | -016       | -011      |           | A               | 310 pF Pi  |
| 56-703 -007                               | -017       | -012      |           | B               | 1000 pF C  |
| 56-703 -008                               | -018       | -013      |           | C               | 1000 pF Pi |
| 56-703 -009                               | -019       | -014      |           | D               | 5000 pF C  |
| * 56-703 -010                             | -020       | * -015    |           | E               | 4000 pF Pi |
| 56-703 -031                               | -028       | -025      |           | F               | 830 pF C   |
| 56-703 -032                               | -029       | -026      |           | J               | 100 pF Pi  |
| 56-703 -033                               | -030       | -027      |           | K               | 2500 pF Pi |
| 56-703 -039                               | -038       | -037      |           | N               | 375 pF C   |



## Solder Cup Termination

| Spectrum Part Number | EMI Filter           |            |
|----------------------|----------------------|------------|
|                      | Filter Designation** | Cap. Value |
| * 56-706-001         | A                    | 310 pF Pi  |
| 56-706-002           | B                    | 1000 pF C  |
| * 56-706-003         | C                    | 1000 pF Pi |
| 56-706-004           | D                    | 5000 pF C  |
| * 56-706-005         | E                    | 4000 pF Pi |
| 56-706-006           | F                    | 830 pF C   |
| 56-706-007           | J                    | 100 pF Pi  |
| * 56-706-008         | K                    | 2500 pF Pi |
| 56-706-009           | N                    | 375 pF C   |
| 56-706-017           | L                    | 500 pF C   |



## Pin/Socket Adapter

| Spectrum Part Number | EMI Filter           |            |
|----------------------|----------------------|------------|
|                      | Filter Designation** | Cap. Value |
| * 56-705-001         | A                    | 310 pF Pi  |
| 56-705-002           | B                    | 1000 pF C  |
| * 56-705-003 €       | C                    | 1000 pF Pi |
| 56-705-004           | D                    | 5000 pF C  |
| * 56-705-005 €       | E                    | 4000 pF Pi |
| * 56-705-008         | F                    | 830 pF C   |
| 56-705-009           | J                    | 100 pF Pi  |
| 56-705-010           | K                    | 2500 pF Pi |
| 56-705-026           | N                    | 375 pF C   |
| 56-705-049           | L                    | 500 pF C   |



€ Also available through API's authorized European distributors/agents.

\* May be available from distributor stock.

\*\* See page FC20 for filter performance.

Standard Tolerance = ±.005 except where noted, φ = ±.015

API TECHNOLOGIES • 8061 Avonia Rd. • Fairview, PA 16415 • Ph: 814-474-1571 • Fax: 814-474-3110 • eis.apitech.com

API TECHNOLOGIES' SPECTRUM CONTROL GmbH • Hansastrasse 6 • 91126 Schwabach, Germany • Phone: (49)-9122-795-0 • Fax: (49)-9122-795-58

Dimensions in inches (mm)

# 15 Series 700 Shell Size Pin Contact



## Printed Circuit Board Mount

| Spectrum Part Number | EMI Filter           |            |
|----------------------|----------------------|------------|
|                      | Filter Designation** | Cap. Value |
| 56-711-001           | A                    | 310 pF Pi  |
| 56-711-002           | B                    | 1000 pF C  |
| 56-711-003           | C                    | 1000 pF Pi |
| 56-711-004           | D                    | 5000 pF C  |
| 56-711-005           | E                    | 4000 pF Pi |
| 56-711-028           | F                    | 830 pF C   |
| 56-711-029           | J                    | 100 pF Pi  |
| 56-711-030           | K                    | 2500 pF Pi |
| 56-711-048           | N                    | 375 pF C   |
| 56-711-088           | L                    | 500 pF C   |

## Printed Circuit Board Right Angle Mount

| Spectrum Part Number | EMI Filter           |            |
|----------------------|----------------------|------------|
|                      | Filter Designation** | Cap. Value |
| * 56-712-001         | A                    | 310 pF Pi  |
| 56-712-002           | B                    | 1000 pF C  |
| * 56-712-003         | C                    | 1000 pF Pi |
| 56-712-004           | D                    | 5000 pF C  |
| * 56-712-005         | E                    | 4000 pF Pi |
| * 56-712-007         | F                    | 830 pF C   |
| 56-712-008           | J                    | 100 pF Pi  |
| 56-712-009           | K                    | 2500 pF Pi |
| 56-712-017           | N                    | 375 pF C   |
| 56-712-039           | L                    | 500 pF C   |

\* May be available from distributor stock.  
 \*\* See page FC20 for filter performance.  
 Standard Tolerance = ±.005 except where noted, ∅ = ±.015

Dimensions in inches (mm)

# 15 Series 700 Shell Size Pin Contact



## Solderless Wire Wrap

| Spectrum Part Number<br><i>Select one</i> | EMI Filter |           |           | Filter<br>Desig.** | Cap. Value |
|---|------------|-----------|-----------|--------------------|------------|
|   | L<br>.500  | L<br>.375 | L<br>.250 |                    |            |
| 56-711 -006 -023 -018                     |            |           |           | A                  | 310 pF Pi  |
| 56-711 -007 -024 -019                     |            |           |           | B                  | 1000 pF C  |
| 56-711 -008 -025 -020                     |            |           |           | C                  | 1000 pF Pi |
| 56-711 -009 -026 -021                     |            |           |           | D                  | 5000 pF C  |
| 56-711 -010 -027 -022                     |            |           |           | E                  | 4000 pF Pi |
| 56-711 -037 -034 -031                     |            |           |           | F                  | 830 pF C   |
| 56-711 -038 -035 -032                     |            |           |           | J                  | 100 pF Pi  |
| 56-711 -039 -036 -033                     |            |           |           | K                  | 2500 pF Pi |
| 56-711 -051 -050 -049                     |            |           |           | N                  | 375 pF C   |



## Solder Cup Termination

| Spectrum Part Number | EMI Filter           |            |
|----------------------|----------------------|------------|
|                      | Filter Designation** | Cap. Value |
| * 56-711-011         | A                    | 310 pF Pi  |
| 56-711-012           | B                    | 1000 pF C  |
| * 56-711-013         | C                    | 1000 pF Pi |
| 56-711-014           | D                    | 5000 pF C  |
| * 56-711-015         | E                    | 4000 pF Pi |
| * 56-711-040         | F                    | 830 pF C   |
| 56-711-041           | J                    | 100 pF Pi  |
| 56-711-042           | K                    | 2500 pF Pi |
| 56-711-085           | N                    | 375 pF C   |
| 56-711-086           | L                    | 500 pF C   |



\* May be available from distributor stock.  
 \*\* See page FC20 for filter performance.  
 Standard Tolerance = ±.005 except where noted, ∅ = ±.015

Dimensions in inches (mm)

# 15 Series 700 Shell Size Socket Contact



## Printed Circuit Board Mount

| Spectrum Part Number | EMI Filter           |            |
|----------------------|----------------------|------------|
|                      | Filter Designation** | Cap. Value |
| 56-713-001           | A                    | 310 pF Pi  |
| 56-713-002           | B                    | 1000 pF C  |
| 56-713-003           | C                    | 1000 pF Pi |
| 56-713-004           | D                    | 5000 pF C  |
| 56-713-005           | E                    | 4000 pF Pi |
| 56-713-021           | F                    | 830 pF C   |
| 56-713-022           | J                    | 100 pF Pi  |
| 56-713-023           | K                    | 2500 pF Pi |
| 56-713-037           | N                    | 375 pF C   |
| 56-713-045           | L                    | 500 pF C   |

## Printed Circuit Board Right Angle Mount

| Spectrum Part Number | EMI Filter           |            |
|----------------------|----------------------|------------|
|                      | Filter Designation** | Cap. Value |
| * 56-714-001         | A                    | 310 pF Pi  |
| 56-714-002           | B                    | 1000 pF C  |
| * 56-714-003         | C                    | 1000 pF Pi |
| 56-714-004           | D                    | 5000 pF C  |
| * 56-714-005         | E                    | 4000 pF Pi |
| * 56-714-006         | F                    | 830 pF C   |
| 56-714-007           | J                    | 100 pF Pi  |
| 56-714-008           | K                    | 2500 pF Pi |
| 56-714-017           | N                    | 375 pF C   |
| 56-714-031           | L                    | 500 pF C   |

\* May be available from distributor stock.

\*\* See page FC20 for filter performance.

Standard Tolerance =  $\pm 0.005$  except where noted,  $\diamond = \pm 0.015$

Dimensions in inches (mm)



# 15 Series 700 Shell Size Socket Contact & Pin/Socket Adapter



## Solderless Wire Wrap

| Spectrum Part Number<br><i>Select one</i> | EMI Filter |           |           | Filter Desig.** | Cap. Value |
|---|------------|-----------|-----------|-----------------|------------|
|   | L<br>.500  | L<br>.375 | L<br>.250 |                 |            |
| 56-713 -006                               | -016       | -011      |           | A               | 310 pF Pi  |
| 56-713 -007                               | -017       | -012      |           | B               | 1000 pF C  |
| 56-713 -008                               | -018       | -013      |           | C               | 1000 pF Pi |
| 56-713 -009                               | -019       | -014      |           | D               | 5000 pF C  |
| 56-713 -010                               | -020       | -015      |           | E               | 4000 pF Pi |
| 56-713 -030                               | -027       | -024      |           | F               | 830 pF C   |
| 56-713 -031                               | -028       | -025      |           | J               | 100 pF Pi  |
| 56-713 -032                               | -029       | -026      |           | K               | 2500 pF Pi |
| 56-713 -040                               | -039       | -038      |           | N               | 375 pF C   |



## Solder Cup Termination

| Spectrum Part Number | EMI Filter           |            |
|----------------------|----------------------|------------|
|                      | Filter Designation** | Cap. Value |
| * 56-716-001         | A                    | 310 pF Pi  |
| 56-716-002           | B                    | 1000 pF C  |
| * 56-716-003         | C                    | 1000 pF Pi |
| 56-716-004           | D                    | 5000 pF C  |
| * 56-716-005         | E                    | 4000 pF Pi |
| 56-716-006           | F                    | 830 pF C   |
| 56-716-007           | J                    | 100 pF Pi  |
| * 56-716-008         | K                    | 2500 pF Pi |
| 56-716-009           | N                    | 375 pF C   |
| 56-716-013           | L                    | 500 pF C   |

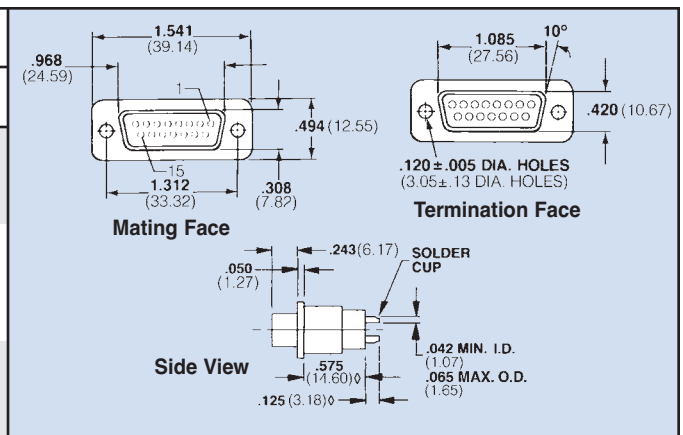

## Pin/Socket Adapter

| Spectrum Part Number | EMI Filter           |            |
|----------------------|----------------------|------------|
|                      | Filter Designation** | Cap. Value |
| * 56-715-001         | A                    | 310 pF Pi  |
| 56-715-002           | B                    | 1000 pF C  |
| * 56-715-003 €       | C                    | 1000 pF Pi |
| 56-715-004           | D                    | 5000 pF C  |
| * 56-715-005 €       | E                    | 4000 pF Pi |
| 56-715-007           | F                    | 830 pF C   |
| 56-715-008           | J                    | 100 pF Pi  |
| 56-715-009           | K                    | 2500 pF Pi |
| 56-715-015           | N                    | 375 pF C   |
| 56-715-040           | L                    | 500 pF C   |

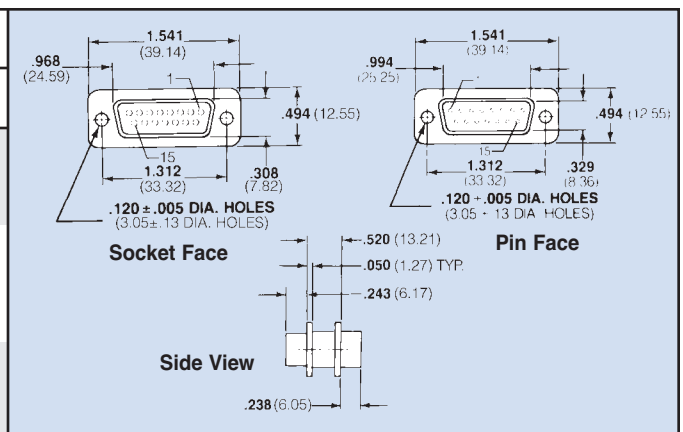

€ Also available through API's authorized European distributors/agents.

\* May be available from distributor stock.

\*\* See page FC20 for filter performance.

Standard Tolerance = ±.005 except where noted, φ = ±.015

API TECHNOLOGIES • 8061 Avonia Rd. • Fairview, PA 16415 • Ph: 814-474-1571 • Fax: 814-474-3110 • eis.apitech.com

API TECHNOLOGIES' SPECTRUM CONTROL GmbH • Hansastrasse 6 • 91126 Schwabach, Germany • Phone: (49)-9122-795-0 • Fax: (49)-9122-795-58

Dimensions in inches (mm)

# 25 Series 700 Shell Size Pin Contact



## Printed Circuit Board Mount

| Spectrum Part Number | EMI Filter           |            |
|----------------------|----------------------|------------|
|                      | Filter Designation** | Cap. Value |
| 56-721-001           | A                    | 310 pF Pi  |
| 56-721-002           | B                    | 1000 pF C  |
| 56-721-003           | C                    | 1000 pF Pi |
| 56-721-004           | D                    | 5000 pF C  |
| 56-721-005           | E                    | 4000 pF Pi |
| 56-721-033           | F                    | 830 pF C   |
| 56-721-034           | J                    | 100 pF Pi  |
| 56-721-035           | K                    | 2500 pF Pi |
| 56-721-063           | N                    | 375 pF C   |
| 56-721-111           | L                    | 500 pF C   |

**Mating Face**

**Termination Face**

**Side View**

## Printed Circuit Board Right Angle Mount

| Spectrum Part Number | EMI Filter           |            |
|----------------------|----------------------|------------|
|                      | Filter Designation** | Cap. Value |
| * 56-722-001         | A                    | 310 pF Pi  |
| 56-722-002           | B                    | 1000 pF C  |
| * 56-722-003         | C                    | 1000 pF Pi |
| 56-722-004           | D                    | 5000 pF C  |
| * 56-722-005         | E                    | 4000 pF Pi |
| * 56-722-008         | F                    | 830 pF C   |
| 56-722-009           | J                    | 100 pF Pi  |
| 56-722-010           | K                    | 2500 pF Pi |
| 56-722-027           | N                    | 375 pF C   |
| 56-722-060           | L                    | 500 pF C   |

**Mating Face**

**Termination Face**

**Bottom View**

**Side View**

\* May be available from distributor stock.

\*\* See page FC20 for filter performance.

Standard Tolerance = ±.005 except where noted, ∅ = ±.015

Dimensions in inches (mm)

# 25 Series 700 Shell Size Pin Contact



## Solderless Wire Wrap

| Spectrum Part Number<br><i>Select one</i> | EMI Filter |           |           |                    |            |
|---|------------|-----------|-----------|--------------------|------------|
|   | L<br>.500  | L<br>.375 | L<br>.250 | Filter<br>Desig.** | Cap. Value |
| 56-721 -006 -028 -024                     |            |           |           | A                  | 310 pF Pi  |
| 56-721 -007 -029 -025                     |            |           |           | B                  | 1000 pF C  |
| 56-721 -008 -030 -026                     |            |           |           | C                  | 1000 pF Pi |
| 56-721 -009 -031 -022                     |            |           |           | D                  | 5000 pF C  |
| 56-721 -010 -032 -027                     |            |           |           | E                  | 4000 pF Pi |
| 56-721 -042 -039 -036                     |            |           |           | F                  | 830 pF C   |
| 56-721 -043 -040 -037                     |            |           |           | J                  | 100 pF Pi  |
| 56-721 -044 -041 -038                     |            |           |           | K                  | 2500 pF Pi |
| 56-721 -066 -065 -064                     |            |           |           | N                  | 375 pF C   |

**Mating Face**

**Termination Face**

**Side View**

## Solder Cup Termination

| Spectrum Part Number | EMI Filter           |            |
|----------------------|----------------------|------------|
|                      | Filter Designation** | Cap. Value |
| * 56-721-011         | A                    | 310 pF Pi  |
| * 56-721-012         | B                    | 1000 pF C  |
| * 56-721-013         | C                    | 1000 pF Pi |
| 56-721-014           | D                    | 5000 pF C  |
| * 56-721-015         | E                    | 4000 pF Pi |
| * 56-721-045         | F                    | 830 pF C   |
| 56-721-046           | J                    | 100 pF Pi  |
| 56-721-047           | K                    | 2500 pF Pi |
| 56-721-070           | N                    | 375 pF C   |
| 56-721-112           | L                    | 500 pF C   |

**Mating Face**

**Termination Face**

**Side View**

\* May be available from distributor stock.  
 \*\* See page FC20 for filter performance.  
 Standard Tolerance = ±.005 except where noted, ∅ = ±.015

Dimensions in inches (mm)

# 25 Series 700 Shell Size Socket Contact



## Printed Circuit Board Mount

| Spectrum Part Number | EMI Filter           |            |
|----------------------|----------------------|------------|
|                      | Filter Designation** | Cap. Value |
| 56-723-001           | A                    | 310 pF Pi  |
| 56-723-002           | B                    | 1000 pF C  |
| 56-723-003           | C                    | 1000 pF Pi |
| 56-723-004           | D                    | 5000 pF C  |
| 56-723-005           | E                    | 4000 pF Pi |
| 56-723-023           | F                    | 830 pF C   |
| 56-723-024           | J                    | 100 pF Pi  |
| 56-723-025           | K                    | 2500 pF Pi |
| 56-723-045           | N                    | 375 pF C   |
| 56-723-069           | L                    | 500 pF C   |

## Printed Circuit Board Right Angle Mount

| Spectrum Part Number | EMI Filter           |            |
|----------------------|----------------------|------------|
|                      | Filter Designation** | Cap. Value |
| * 56-724-001         | A                    | 310 pF Pi  |
| 56-724-002           | B                    | 1000 pF C  |
| * 56-724-003         | C                    | 1000 pF Pi |
| 56-724-004           | D                    | 5000 pF C  |
| * 56-724-005         | E                    | 4000 pF Pi |
| * 56-724-008         | F                    | 830 pF C   |
| 56-724-009           | J                    | 100 pF Pi  |
| 56-724-010           | K                    | 2500 pF Pi |
| 56-724-021           | N                    | 375 pF C   |
| 56-724-046           | L                    | 500 pF C   |

\* May be available from distributor stock.

\*\* See page FC20 for filter performance.

Standard Tolerance = ±.005 except where noted, ∅ = ±.015

Dimensions in inches (mm)

# 25 Series 700 Shell Size Pin/Socket Adapter



## Solderless Wire Wrap

| Spectrum Part Number<br><i>Select one</i> | EMI Filter |           |           | Filter Desig.** | Cap. Value |
|---|------------|-----------|-----------|-----------------|------------|
|   | L<br>.500  | L<br>.375 | L<br>.250 |                 |            |
| * 56-723 -006                             | -017       | * -012    | A         | 310 pF Pi       |            |
| 56-723 -007                               | -018       | -013      | B         | 1000 pF C       |            |
| * 56-723 -008                             | -019       | * -014    | C         | 1000 pF Pi      |            |
| 56-723 -009                               | -020       | -015      | D         | 5000 pF C       |            |
| * 56-723 -010                             | -021       | * -016    | E         | 4000 pF Pi      |            |
| * 56-723 -032                             | -029       | * -026    | F         | 830 pF C        |            |
| 56-723 -033                               | -030       | -027      | J         | 100 pF Pi       |            |
| 56-723 -034                               | -031       | -028      | K         | 2500 pF Pi      |            |
| 56-723 -048                               | -047       | -046      | N         | 375 pF C        |            |

## Solder Cup Termination

| Spectrum Part Number | EMI Filter           |            |
|----------------------|----------------------|------------|
|                      | Filter Designation** | Cap. Value |
| * 56-726-001         | A                    | 310 pF Pi  |
| 56-726-002           | B                    | 1000 pF C  |
| * 56-726-003         | C                    | 1000 pF Pi |
| 56-726-004           | D                    | 5000 pF C  |
| * 56-726-005         | E                    | 4000 pF Pi |
| 56-726-006           | F                    | 830 pF C   |
| 56-726-007           | J                    | 100 pF Pi  |
| * 56-726-008         | K                    | 2500 pF Pi |
| 56-726-009           | N                    | 375 pF C   |
| 56-726-021           | L                    | 500 pF C   |

## Pin/Socket Adapter

| Spectrum Part Number | EMI Filter           |            |
|----------------------|----------------------|------------|
|                      | Filter Designation** | Cap. Value |
| * 56-725-001         | A                    | 310 pF Pi  |
| 56-725-002           | B                    | 1000 pF C  |
| * 56-725-003 €       | C                    | 1000 pF Pi |
| 56-725-004           | D                    | 5000 pF C  |
| * 56-725-005 €       | E                    | 4000 pF Pi |
| * 56-725-019         | F                    | 830 pF C   |
| 56-725-020           | J                    | 100 pF Pi  |
| * 56-725-021         | K                    | 2500 pF Pi |
| 56-725-064           | N                    | 375 pF C   |
| 56-725-073           | L                    | 500 pF C   |

€ Also available through API's authorized European distributors/agents.

\* May be available from distributor stock.

\*\* See page FC20 for filter performance.

Standard Tolerance = ±.005 except where noted, ∅ = ±.015

API TECHNOLOGIES • 8061 Avonia Rd. • Fairview, PA 16415 • Ph: 814-474-1571 • Fax: 814-474-3110 • eis.apitech.com

API TECHNOLOGIES' SPECTRUM CONTROL GmbH • Hansastrasse 6 • 91126 Schwabach, Germany • Phone: (49)-9122-795-0 • Fax: (49)-9122-795-58

Dimensions in inches (mm)

# 37 Series 700 Shell Size Pin Contact



## Printed Circuit Board Mount

| Spectrum Part Number | EMI Filter           |            |
|----------------------|----------------------|------------|
|                      | Filter Designation** | Cap. Value |
| 56-731-001           | A                    | 310 pF Pi  |
| 56-731-002           | B                    | 1000 pF C  |
| 56-731-003           | C                    | 1000 pF Pi |
| 56-731-004           | D                    | 5000 pF C  |
| 56-731-005           | E                    | 4000 pF Pi |
| 56-731-028           | F                    | 830 pF C   |
| 56-731-029           | J                    | 100 pF Pi  |
| 56-731-030           | K                    | 2500 pF Pi |
| 56-731-048           | N                    | 375 pF C   |
| 56-731-076           | L                    | 500 pF C   |

## Printed Circuit Board Right Angle Mount

| Spectrum Part Number | EMI Filter           |            |
|----------------------|----------------------|------------|
|                      | Filter Designation** | Cap. Value |
| 56-732-001           | A                    | 310 pF Pi  |
| 56-732-002           | B                    | 1000 pF C  |
| * 56-732-003         | C                    | 1000 pF Pi |
| 56-732-004           | D                    | 5000 pF C  |
| * 56-732-005         | E                    | 4000 pF Pi |
| 56-732-006           | F                    | 830 pF C   |
| 56-732-007           | J                    | 100 pF Pi  |
| 56-732-008           | K                    | 2500 pF Pi |
| 56-732-009           | N                    | 375 pF C   |
| 56-732-023           | L                    | 500 pF C   |

\* May be available from distributor stock.  
 \*\* See page FC20 for filter performance.  
 Standard Tolerance = ±.005 except where noted, ∅ = ±.015

Dimensions in inches (mm)

# 37 Series 700 Shell Size Pin Contact



## Solderless Wire Wrap

| Spectrum Part Number<br><i>Select one</i> | EMI Filter |           |           |                    |            |
|---|------------|-----------|-----------|--------------------|------------|
|   | L<br>.500  | L<br>.375 | L<br>.250 | Filter<br>Desig.** | Cap. Value |
| 56-731 -006 -023 -018                     |            |           |           | A                  | 310 pF Pi  |
| 56-731 -007 -024 -019                     |            |           |           | B                  | 1000 pF C  |
| 56-731 -008 -025 -020                     |            |           |           | C                  | 1000 pF Pi |
| 56-731 -009 -026 -021                     |            |           |           | D                  | 5000 pF C  |
| 56-731 -010 -027 -022                     |            |           |           | E                  | 4000 pF Pi |
| 56-731 -037 -034 -031                     |            |           |           | F                  | 830 pF C   |
| 56-731 -038 -035 -032                     |            |           |           | J                  | 100 pF Pi  |
| 56-731 -039 -036 -033                     |            |           |           | K                  | 2500 pF Pi |
| 56-731 -051 -050 -049                     |            |           |           | N                  | 375 pF C   |

## Solder Cup Termination

| Spectrum Part Number | EMI Filter           |            |
|----------------------|----------------------|------------|
|                      | Filter Designation** | Cap. Value |
| * 56-731-011         | A                    | 310 pF Pi  |
| 56-731-012           | B                    | 1000 pF C  |
| * 56-731-013         | C                    | 1000 pF Pi |
| 56-731-014           | D                    | 5000 pF C  |
| * 56-731-015         | E                    | 4000 pF Pi |
| * 56-731-040         | F                    | 830 pF C   |
| 56-731-041           | J                    | 100 pF Pi  |
| 56-731-042           | K                    | 2500 pF Pi |
| 56-731-060           | N                    | 375 pF C   |
| 56-731-077           | L                    | 500 pF C   |

\* May be available from distributor stock.  
\*\* See page FC20 for filter performance.  
Standard Tolerance = ±.005 except where noted, Ø = ±.015

Dimensions in inches (mm)

# 37 Series 700 Shell Size Socket Contact



## Printed Circuit Board Mount

| Spectrum Part Number | EMI Filter           |            |
|----------------------|----------------------|------------|
|                      | Filter Designation** | Cap. Value |
| 56-733-001           | A                    | 310 pF Pi  |
| 56-733-002           | B                    | 1000 pF C  |
| 56-733-003           | C                    | 1000 pF Pi |
| 56-733-004           | D                    | 5000 pF C  |
| 56-733-005           | E                    | 4000 pF Pi |
| 56-733-021           | F                    | 830 pF C   |
| 56-733-022           | J                    | 100 pF Pi  |
| 56-733-023           | K                    | 2500 pF Pi |
| 56-733-035           | N                    | 375 pF C   |
| 56-733-046           | L                    | 500 pF C   |

## Printed Circuit Board Right Angle Mount

| Spectrum Part Number | EMI Filter           |            |
|----------------------|----------------------|------------|
|                      | Filter Designation** | Cap. Value |
| 56-734-001           | A                    | 310 pF Pi  |
| 56-734-002           | B                    | 1000 pF C  |
| 56-734-003           | C                    | 1000 pF Pi |
| 56-734-004           | D                    | 5000 pF C  |
| 56-734-005           | E                    | 4000 pF Pi |
| 56-734-006           | F                    | 830 pF C   |
| 56-734-007           | J                    | 100 pF Pi  |
| 56-734-008           | K                    | 2500 pF Pi |
| 56-734-012           | N                    | 375 pF C   |
| 56-734-021           | L                    | 500 pF C   |

\* May be available from distributor stock.

\*\* See page FC20 for filter performance.

Standard Tolerance =  $\pm 0.005$  except where noted,  $\diamond = \pm 0.015$

Dimensions in inches (mm)



# 37 Series 700 Shell Size Socket Contact & Pin/Socket Adapter



## Solderless Wire Wrap

| Spectrum Part Number<br><i>Select one</i> | EMI Filter |           |           | Filter<br>Desig.** | Cap. Value |  |  |
|---|------------|-----------|-----------|--------------------|------------|--|--|
|   | L<br>.500  | L<br>.375 | L<br>.250 |                    |            |  |  |
| * 56-733 -006                             | -016       | * -011    | A         | 310 pF Pi          |            |  |  |
| 56-733 -007                               | -017       | -012      | B         | 1000 pF C          |            |  |  |
| 56-733 -008                               | -018       | -013      | C         | 1000 pF Pi         |            |  |  |
| 56-733 -009                               | -019       | -014      | D         | 5000 pF C          |            |  |  |
| 56-733 -010                               | -020       | -015      | E         | 4000 pF Pi         |            |  |  |
| 56-733 -030                               | -027       | -024      | F         | 830 pF C           |            |  |  |
| 56-733 -031                               | -028       | -025      | J         | 100 pF Pi          |            |  |  |
| 56-733 -032                               | -029       | -026      | K         | 2500 pF Pi         |            |  |  |
| 56-733 -038                               | -037       | -036      | N         | 375 pF C           |            |  |  |
|   |            |           | L         | 500 pF C           |            |  |  |

## Solder Cup Termination

| Spectrum Part Number | EMI Filter           |            |  |  |
|----------------------|----------------------|------------|--|--|
|                      | Filter Designation** | Cap. Value |  |  |
| * 56-736-001         | A                    | 310 pF Pi  |  |  |
| 56-736-002           | B                    | 1000 pF C  |  |  |
| * 56-736-003         | C                    | 1000 pF Pi |  |  |
| 56-736-004           | D                    | 5000 pF C  |  |  |
| * 56-736-005         | E                    | 4000 pF Pi |  |  |
| 56-736-006           | F                    | 830 pF C   |  |  |
| 56-736-007           | J                    | 100 pF Pi  |  |  |
| * 56-736-008         | K                    | 2500 pF Pi |  |  |
| 56-736-009           | N                    | 375 pF C   |  |  |
| 56-736-015           | L                    | 500 pF C   |  |  |

## Pin/Socket Adapter

| Spectrum Part Number | EMI Filter           |            |  |  |
|----------------------|----------------------|------------|--|--|
|                      | Filter Designation** | Cap. Value |  |  |
| * 56-735-001         | A                    | 310 pF Pi  |  |  |
| 56-735-002           | B                    | 1000 pF C  |  |  |
| * 56-735-003 €       | C                    | 1000 pF Pi |  |  |
| 56-735-004           | D                    | 5000 pF C  |  |  |
| * 56-735-005 €       | E                    | 4000 pF Pi |  |  |
| * 56-735-008         | F                    | 830 pF C   |  |  |
| 56-735-009           | J                    | 100 pF Pi  |  |  |
| 56-735-010           | K                    | 2500 pF Pi |  |  |
| 56-735-025           | N                    | 375 pF C   |  |  |
| 56-735-034           | L                    | 500 pF C   |  |  |

€ Also available through API's authorized European distributors/agents.

\* May be available from distributor stock.

\*\* See page FC20 for filter performance.

Standard Tolerance = ±.005 except where noted, ∅ = ±.015

API TECHNOLOGIES • 8061 Avonia Rd. • Fairview, PA 16415 • Ph: 814-474-1571 • Fax: 814-474-3110 • eis.apitech.com

API TECHNOLOGIES' SPECTRUM CONTROL GmbH • Hansastrasse 6 • 91126 Schwabach, Germany • Phone: (49)-9122-795-0 • Fax: (49)-9122-795-58

Dimensions in inches (mm)

**50** Series 700  
Shell Size Pin Contact



**Printed Circuit Board Mount**

| Spectrum Part Number | EMI Filter           |            |
|----------------------|----------------------|------------|
|                      | Filter Designation** | Cap. Value |
| 56-741-001           | A                    | 310 pF Pi  |
| 56-741-002           | B                    | 1000 pF C  |
| 56-741-003           | C                    | 1000 pF Pi |
| 56-741-004           | D                    | 5000 pF C  |
| 56-741-005           | E                    | 4000 pF Pi |
| 56-741-027           | F                    | 830 pF C   |
| 56-741-028           | J                    | 100 pF Pi  |
| 56-741-029           | K                    | 2500 pF Pi |
| 56-741-042           | N                    | 375 pF C   |
| 56-741-066           | L                    | 500 pF C   |

**Mating Face**

**Termination Face**

**Side View**

**Printed Circuit Board Right Angle Mount**

| Spectrum Part Number | EMI Filter           |            |
|----------------------|----------------------|------------|
|                      | Filter Designation** | Cap. Value |
| 56-742-001           | A                    | 310 pF Pi  |
| 56-742-002           | B                    | 1000 pF C  |
| 56-742-003           | C                    | 1000 pF Pi |
| 56-742-004           | D                    | 5000 pF C  |
| 56-742-005           | E                    | 4000 pF Pi |
| 56-742-006           | F                    | 830 pF C   |
| 56-742-007           | J                    | 100 pF Pi  |
| 56-742-008           | K                    | 2500 pF Pi |
| 56-742-009           | N                    | 375 pF C   |
| 56-742-022           | L                    | 500 pF C   |

**Mating Face**

**Termination Face**

**Side View**

**Bottom View**

\* May be available from distributor stock.  
 \*\* See page FC20 for filter performance.  
 Standard Tolerance = ±.005 except where noted, ∅ = ±.015

Dimensions in inches (mm)

# 50 Series 700 Shell Size Pin Contact



## Solderless Wire Wrap

| Spectrum Part Number<br><i>Select one</i> | EMI Filter |           |           |                    |            |
|---|------------|-----------|-----------|--------------------|------------|
|   | L<br>.500  | L<br>.375 | L<br>.250 | Filter<br>Desig.** | Cap. Value |
| 56-741 -006 -022 -017                     |            |           |           | A                  | 310 pF Pi  |
| 56-741 -007 -023 -018                     |            |           |           | B                  | 1000 pF C  |
| 56-741 -008 -024 -019                     |            |           |           | C                  | 1000 pF Pi |
| 56-741 -009 -025 -020                     |            |           |           | D                  | 5000 pF C  |
| 56-741 -010 -026 -021                     |            |           |           | E                  | 4000 pF Pi |
| 56-741 -036 -033 -030                     |            |           |           | F                  | 830 pF C   |
| 56-741 -037 -034 -031                     |            |           |           | J                  | 100 pF Pi  |
| 56-741 -038 -035 -032                     |            |           |           | K                  | 2500 pF Pi |
| 56-741 -045 -044 -043                     |            |           |           | N                  | 375 pF C   |

## Solder Cup Termination

| Spectrum Part Number | EMI Filter           |            |
|----------------------|----------------------|------------|
|                      | Filter Designation** | Cap. Value |
| * 56-741-011         | A                    | 310 pF Pi  |
| * 56-741-012         | B                    | 1000 pF C  |
| * 56-741-013         | C                    | 1000 pF Pi |
| * 56-741-014         | D                    | 5000 pF C  |
| * 56-741-015         | E                    | 4000 pF Pi |
| 56-741-039           | F                    | 830 pF C   |
| 56-741-040           | J                    | 100 pF Pi  |
| 56-741-041           | K                    | 2500 pF Pi |
| 56-741-063           | N                    | 375 pF C   |
| 56-741-067           | L                    | 500 pF C   |

\* May be available from distributor stock.  
 \*\* See page FC20 for filter performance.  
 Standard Tolerance = ±.005 except where noted, ∅ = ±.015

Dimensions in inches (mm)

# 50 Series 700 Shell Size Socket Contact



## Printed Circuit Board Mount

| Spectrum Part Number | EMI Filter           |            |
|----------------------|----------------------|------------|
|                      | Filter Designation** | Cap. Value |
| 56-743-001           | A                    | 310 pF Pi  |
| 56-743-002           | B                    | 1000 pF C  |
| 56-743-003           | C                    | 1000 pF Pi |
| 56-743-004           | D                    | 5000 pF C  |
| 56-743-005           | E                    | 4000 pF Pi |
| 56-743-021           | F                    | 830 pF C   |
| 56-743-022           | J                    | 100 pF Pi  |
| 56-743-023           | K                    | 2500 pF Pi |
| 56-743-033           | N                    | 375 pF C   |
| 56-743-043           | L                    | 500 pF C   |

**Mating Face**  
 Dimensions: 2.635 (66.93) total length, 2.062 (52.37) inner length, .605 (15.37) height, .420 (10.67) mounting hole offset, 2.406 (61.11) distance between mounting holes, .50 hole offset.

**Termination Face**  
 Dimensions: 2.170 (55.12) length, 10° angle, .527 (13.39) height, .120 ± .005 DIA. HOLES (3.05 ± .13 DIA. HOLES).

**Side View**  
 Dimensions: .050 (1.27) top offset, .243 (6.17) top width, .025 SQ. (.64 SQ.) top hole, .150 (3.81) φ top hole, .425 (10.80) φ bottom hole.

## Printed Circuit Board Right Angle Mount

| Spectrum Part Number | EMI Filter           |            |
|----------------------|----------------------|------------|
|                      | Filter Designation** | Cap. Value |
| 56-744-001           | A                    | 310 pF Pi  |
| 56-744-002           | B                    | 1000 pF C  |
| 56-744-003           | C                    | 1000 pF Pi |
| 56-744-004           | D                    | 5000 pF C  |
| 56-744-005           | E                    | 4000 pF Pi |
| 56-744-006           | F                    | 830 pF C   |
| 56-744-007           | J                    | 100 pF Pi  |
| 56-744-008           | K                    | 2500 pF Pi |
| 56-744-009           | N                    | 375 pF C   |
| 56-744-012           | L                    | 500 pF C   |

**Mating Face**  
 Dimensions: 2.635 (66.93) total length, 2.062 (52.37) inner length, .605 (15.37) height, .420 (10.67) mounting hole offset, 2.406 (61.11) distance between mounting holes, .50 hole offset.

**Termination Face**  
 Dimensions: 2.170 (55.12) length, 10° angle, .527 (13.39) height, .120 ± .005 DIA. HOLES (3.05 ± .13 DIA. HOLES), .020 ± .005 (.51 ± .13) offset.

**Bottom View**  
 Dimensions: .12R (3.05R) top offset, 2.038 (51.77) length, .400 (10.16) height, .275 (6.99) offset, .850 (21.59) total width, .540 (13.72) φ hole.

**Side View**  
 Dimensions: .375 (9.53) top offset, .090 (2.29) top width, .050 (1.27) top hole, .243 (6.17) top hole, .105 (2.67) φ top hole, .025 SQ. (.64 SQ.) top hole, .590 (14.99) φ top hole, .702 (17.83) φ top hole, .814 (20.68) φ top hole.

\* May be available from distributor stock.  
 \*\* See page FC20 for filter performance.  
 Standard Tolerance = ±.005 except where noted, φ = ±.015

Dimensions in inches (mm)

# 50 Series 700 Shell Size Pin/Socket Adapter



## Solderless Wire Wrap

| Spectrum Part Number<br><i>Select one</i> | EMI Filter |           |           | Filter Design.** | Cap. Value |
|---|------------|-----------|-----------|------------------|------------|
|   | L<br>.500  | L<br>.375 | L<br>.250 |                  |            |
| 56-743                                    | -006       | -016      | -011      | A                | 310 pF Pi  |
| 56-743                                    | -007       | -017      | -012      | B                | 1000 pF C  |
| 56-743                                    | -008       | -018      | -013      | C                | 1000 pF Pi |
| 56-743                                    | -009       | -019      | -014      | D                | 5000 pF C  |
| 56-743                                    | -010       | -020      | -015      | E                | 4000 pF Pi |
| 56-743                                    | -030       | -027      | -024      | F                | 830 pF C   |
| 56-743                                    | -031       | -028      | -025      | J                | 100 pF Pi  |
| 56-743                                    | -032       | -029      | -026      | K                | 2500 pF Pi |
| 56-743                                    | -036       | -035      | -034      | N                | 375 pF C   |

**Mating Face**

**Termination Face**

**Side View**

## Solder Cup Termination

| Spectrum Part Number | EMI Filter           |            |
|----------------------|----------------------|------------|
|                      | Filter Designation** | Cap. Value |
| 56-746-001           | A                    | 310 pF Pi  |
| 56-746-002           | B                    | 1000 pF C  |
| 56-746-003           | C                    | 1000 pF Pi |
| 56-746-004           | D                    | 5000 pF C  |
| 56-746-005           | E                    | 4000 pF Pi |
| 56-746-006           | F                    | 830 pF C   |
| 56-746-007           | J                    | 100 pF Pi  |
| 56-746-008           | K                    | 2500 pF Pi |
| 56-746-009           | N                    | 375 pF C   |
| 56-746-018           | L                    | 500 pF C   |

**Mating Face**

**Termination Face**

**Side View**

## Pin/Socket Adapter

| Spectrum Part Number | EMI Filter           |            |
|----------------------|----------------------|------------|
|                      | Filter Designation** | Cap. Value |
| * 56-745-001         | A                    | 310 pF Pi  |
| 56-745-002           | B                    | 1000 pF C  |
| * 56-745-003         | C                    | 1000 pF Pi |
| 56-745-004           | D                    | 5000 pF C  |
| * 56-745-005         | E                    | 4000 pF Pi |
| 56-745-006           | F                    | 830 pF C   |
| 56-745-007           | J                    | 100 pF Pi  |
| 56-745-008           | K                    | 2500 pF Pi |
| 56-745-019           | N                    | 375 pF C   |
| 56-745-027           | L                    | 500 pF C   |

**Socket Face**

**Pin Face**

**Side View**

\* May be available from distributor stock.  
\*\* See page FC20 for filter performance.  
Standard Tolerance = ±.005 except where noted,  $\phi$  = ±.015

Dimensions in inches (mm)

# D-Subminiature Part Numbering System

## Ordering Information

Example: **56-513-012-TI**

**56** - **5** **1** **3** - **0** **12** - **TI**



To assist your efforts in selecting the correct Filtered Connector to meet your needs, we have developed a part numbering system. All of the standard products are shown in their respective catalog pages.

Part number **56-513-012-TI** represents a Series 500 connector with 15 contacts in a socket to straight PCB mount configuration. All connector positions have a capacitance value of 840 pF and there are 4-40 threads on mounting flange.

# D-Subminiature Connector Options

## Threaded Inserts

Available on Series 500, 600 & 700

- #4-40 UNC or metric M3.0 threaded inserts in mounting flanges
- Allows ease of panel-assembly
- Plated steel inserts with last thread upset for torque

## Grounding Bracket

For right angle mount PCB connectors, available on Series 700

- Metal bracket in place of plastic
- Provides ground connection direct from circuit board
- Allows shell grounding to board
- Includes 4-40 threads

## Stand-off with Board Lock Feature

For straight PCB connectors, available on Series 700

- Allows shell grounding to board
- Eliminates stress on filter terminations
- Tin plated brass stand-off with snap-in feature
- Available for .062" (1.57mm) or .093" (2.36mm) thick boards

## Grounding Bracket with Board Lock

For right angle mount PCB connectors, available on Series 500 & 700

- Metal bracket provides grounding
- Snap-in, no hardware needed, 4-40 threads included
- For use on .062" (1.57mm) thick boards

## Gold Plating

Available on Series 600 & 700

- High reliability applications, 50µ" (1.27 µm) gold over 50µ" (1.27 µm) nickel

## Solder Dipped Tails

Available on Series 600 & 700 connectors

- Solder dipped tails added to standard gold flash

## Water Block

Consult API engineers for specifics.

- Internally sealed in accordance with NEMA Standard Rain Test section 6.4 (also UL50 part 28 ram test for submersion, section 6.10.1)

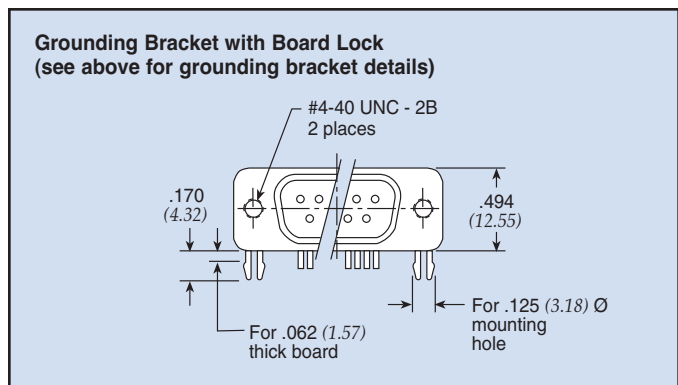
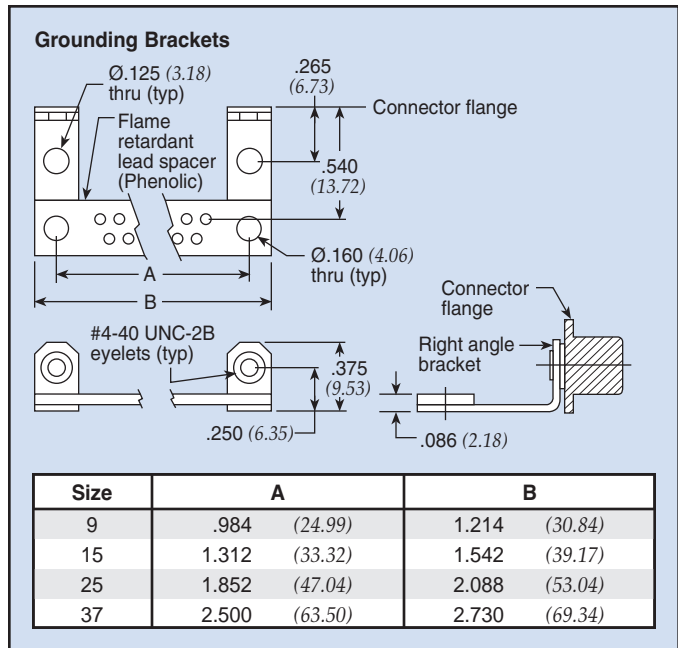

Dimensions in inches (mm)

# Filtered Combo D-Subminiature Connectors

API's Spectrum Control line of filtered combo D-sub provide high insertion loss with capacitive filtering. These connectors are available with 20 Amp power contacts or 40 Amp power contacts. Configurations include male and female versions with straight PC terminals, right angle PC terminals or solder cup terminals. Standard D-sub shell sizes provide intermateability with unfiltered connectors. High strength epoxy potting protects ceramic elements.

Capacitive filtering is available in 470, 820, 1000 and 1500 pF. Additional capacitance ranges and configurations can be provided upon request. Please consult factory for more information.

## Applications

- Telecommunications base station equipment
- Switching and transmission equipment
- Power supplies
- Industrial equipment
- Computer work stations

## Ordering Information

Example: **563A03W3101GBL9**



\* Insert "F" for RoHS compliant



## Mechanical Specifications

|  |  |
|--|--|
| <i>Shell</i> . . . . .                 | Steel, tin plated  |
| <i>Power Contacts</i> . . . . .        | Brass, gold plated .000030 in. (0.762 μm) minimum  |
| <i>Signal Contacts</i> . . . . .       | Pin: brass, gold plated .000015 in. (0.762 μm) min.<br>Socket: copper alloy, gold plated .000030 in. (0.762 μm) min. |
| <i>Insulator</i> . . . . .             | Glass-filled polyester, flammability UL94V-0   |
| <i>Operating Temperature</i> . . . . . | -55°C to +125°C  |
| <i>Capacitors</i> . . . . .            | MLCC   |

## Electrical Specifications

|  |   |
|--|---|
| <i>Operating Voltage</i> . . . . .     | 200 VDC   |
| <i>Current Rating*</i> . . . . .       | 40 Amp power/ 5 Amp signal  |
| <i>Insulation Resistance</i> . . . . . | 1 Gohm at 100 VDC   |
| <i>Capacitance</i> . . . . .           | See below for MLCC values.<br>For other capacitance values contact factory. |

|  |         |
|--|---------|
| <i>Dielectric Withstanding Voltage</i> . . . . . | 600 VDC |
|--|---------|

\*30 Amp available. Consult factory.



# Filtered Combo D-Subminiature Connectors 3W3

## Plug - Solder Cup



Only represents a few of our available configurations. Consult factory for more information.

Dimensions in inches (mm)

# Filtered Combo D-Subminiature Connectors 3W3

## Plug - Right Angle



Only represents a few of our available configurations. Consult factory for more information.

Dimensions in inches (mm)

# Filtered Combo D-Subminiature Connectors 5W5

## Plug - Vertical



**Recommended PCB Layout**

Only represents a few of our available configurations. Consult factory for more information.

Dimensions in inches (mm)

# Filtered Combo D-Subminiature Connectors 9W4

## Socket - Solder Cup



Only represents a few of our available configurations. Consult factory for more information.

Dimensions in inches (mm)

# Filtered Combo D-Subminiature Connectors 9W4

## Socket - Vertical



Only represents a few of our available configurations. Consult factory for more information.

Dimensions in inches (mm)

# Filtered Combo D-Subminiature Connectors 9W4

## Plug - Right Angle



**Recommended PC Board Mounting Dimensions**

Only represents a few of our available configurations. Consult factory for more information.

Dimensions in inches (mm)

# Filtered Combo D-Subminiature Connectors 24W7

## Socket - Solder Cup



Only represents a few of our available configurations. Consult factory for more information.

Dimensions in inches (mm)

# D-Subminiature Adapter Test Kit & Hardware

## Adapter Test Kit

Specially designed for EMI evaluation process

- Male/female adapter part
- Easily plugged into equipment under testing conditions
- Ideal for new products and retrofitting
- Each adapter test kit includes:
  - 20 filtered adapters
  - Four shell sizes 9, 15, 25 and 37
  - Four filter ranges:
    - Series 700**
    - 310 pF Pi
    - 830 pF FT
    - 1000 pF Pi
    - 4000 pF Pi

## Ordering Information

| Description  | API Part Number    |
|--|--------------------|
| <b>Adapter test kit</b>  | 56-700-002         |
| <b>Adapter test kit with Jackscrew</b><br><i>Includes 40 pcs. 56-201-006</i> | 56-700-002-JS      |
| <b>Hexagonal Spacer</b>  | 56-201-001 (1 per) |
| <b>Jackscrew Mounting Hardware</b><br><i>For .312" (7.92 mm) length</i>      | 56-201-004 (1 per) |
| <b>Jackscrew Mounting Hardware</b><br><i>For .688" (17.47 mm) length</i>     | 56-201-006 (2 per) |
| <b>Tubular Spacer</b>  | 56-201-003 (1 per) |



Adapter Test Kit

## Hardware

Designed to provide simple and effective mounting

### Hexagonal Spacer

- Tapped spacer fits between flanges
- Provide retrofit of 4-40" threads
- Two spacers per adapter required, packaged in bulk



## Jackscrew Mounting Hardware

- Male/female jackscrews
- Standard 4-40 threads for compatibility
- Two male thread lengths available
- Two screws per adapter required
- Lockwasher included, packaged in bulk



# Micro D Series Filtered Connectors

For designs that require even smaller connector packages, API's Spectrum Control brand has designed a line of filtered Micro D-Subminiature connectors. This line of connectors offers a range of reliable filtering options, including capacitive and ESD versions, and several sizes and termination options. API has a Micro D-sub connector to satisfy your smallest space constraints.

## Features

- Light weight
- Compact size
- Environmentally sealed contact area when mated
- Corrosion resistant
- Durable (500 cycles min.)
- Superior electrical performance
- RoHS compliant



## Mechanical Specifications

|                                   |  |
|-----------------------------------|--|
| <i>Shell</i> . . . . .            | Aluminum, electroless nickel plated 500 μ in (12.7 μm) minimum |
| <i>Insulator</i> . . . . .        | High temperature plastic, flammability UL94V-0                 |
| <i>Contacts</i> . . . . .         | Copper alloy, gold plated 50 μ in (1.27 μm) minimum            |
| <i>Potting</i> . . . . .          | Flammability UL94V-0   |
| <i>Interfacial Seal</i> . . . . . | Silicon  |

## Electrical Specifications

|  |                   |
|--|-------------------|
| <i>Operating Voltage</i> . . . . .               | 100 VDC           |
| <i>Dielectric Withstanding Voltage</i> . . . . . | 300 VDC           |
| <i>Current Rating</i> . . . . .                  | 3 Amps            |
| <i>Insulation Resistance</i> . . . . .           | 5G ohms @ 100 VDC |

## Ordering Information

Example: **56-F011-110-JP**



*This part number represents a micro D-sub connector with a shell size of 15 and a pin to solder cup configuration. All lines are filtered with same capacitance value, which is 100 pF COB. The connector includes an optional #2-56 jack post.*

\* Right angle and PC tail length is 0.109. Other lengths available, consult factory.

All capacitance values ±20% @ 25°C

# Micro D Series Filtered Connectors

## High Performance

| Filter Designation | Type | Capacitance |           | Dielectric Withstanding Voltage | Working Voltage DC -55°C to +125°C | Minimum Insertion Loss - Decibels (dB) 50 ohm system per MIL-STD-220 (no load) |        |        |        |         |         |         |       |
|--------------------|------|-------------|-----------|---------------------------------|------------------------------------|--|--------|--------|--------|---------|---------|---------|-------|
|                    |      | Value       | Tolerance |                                 |                                    | 5 MHz  | 10 MHz | 20 MHz | 50 MHz | 100 MHz | 200 MHz | 500 MHz | 1 GHz |
| 01                 | FT   | 100 pF      | ±20%      | 300V                            | 100V                               | —  | —      | —      | —      | 1       | 6       | 14      | 20    |
| 02                 | FT   | 470 pF      | ±20%      | 300V                            | 100V                               | —  | —      | 2      | 8      | 14      | 20      | 28      | 34    |
| 03                 | FT   | 820 pF      | ±20%      | 300V                            | 100V                               | —  | 2      | 6      | 13     | 19      | 25      | 33      | 39    |
| 04                 | FT   | 1500 pF     | ±20%      | 300V                            | 100V                               | —  | 5      | 10     | 18     | 24      | 30      | 38      | 44    |
| 05                 | FT   | 4700 pF     | ±20%      | 300V                            | 100V                               | 8  | 14     | 20     | 28     | 34      | 40      | 48      | 54    |

## Standard Performance

| Filter Designation | Type | Capacitance |           | Dielectric Withstanding Voltage | Working Voltage DC -55°C to +125°C | Minimum Insertion Loss - Decibels (dB) 50 ohm system per MIL-STD-220 (no load) |        |        |        |         |         |         |       |
|--------------------|------|-------------|-----------|---------------------------------|------------------------------------|--|--------|--------|--------|---------|---------|---------|-------|
|                    |      | Value       | Tolerance |                                 |                                    | 5 MHz  | 10 MHz | 20 MHz | 50 MHz | 100 MHz | 200 MHz | 500 MHz | 1 GHz |
| 10                 | COB  | 100 pF      | ±20%      | 300V                            | 100V                               | —  | —      | —      | —      | 1       | 6       | 14      | 20    |
| 11                 | COB  | 470 pF      | ±20%      | 300V                            | 100V                               | —  | —      | 2      | 8      | 14      | 20      | 28      | 32    |
| 12                 | COB  | 820 pF      | ±20%      | 300V                            | 100V                               | —  | 2      | 6      | 13     | 19      | 25      | 32      | 32    |
| 13                 | COB  | 1500 pF     | ±20%      | 300V                            | 100V                               | —  | 5      | 10     | 18     | 24      | 30      | 32      | 32    |
| 14                 | COB  | 4700 pF     | ±20%      | 300V                            | 100V                               | 8  | 14     | 20     | 28     | 32      | 32      | 32      | 32    |

## Right Angle PCB

### Receptacle



### Plug



| Size | A             | B             | C (RCPT)      | C (Plug)      | D             | E  | F  | G            | H            |
|------|---------------|---------------|---------------|---------------|---------------|----|----|--------------|--------------|
| 9    | .775 (19.69)  | .565 (14.35)  | .388 (9.86)   | .330 (8.38)   | .390 (9.91)   | 4  | 5  | .200 (5.08)  | .250 (6.35)  |
| 15   | .925 (23.50)  | .715 (18.16)  | .538 (13.67)  | .480 (12.19)  | .540 (13.72)  | 7  | 8  | .350 (8.89)  | .400 (10.16) |
| 21   | 1.075 (27.31) | .865 (21.97)  | .688 (17.48)  | .630 (16.00)  | .690 (17.53)  | 10 | 11 | .500 (12.70) | .550 (13.97) |
| 25   | 1.175 (29.85) | .965 (24.51)  | .788 (20.02)  | .730 (18.54)  | .790 (20.07)  | 12 | 13 | .600 (15.24) | .650 (16.51) |
| 31   | 1.325 (33.66) | 1.115 (28.32) | .938 (23.83)  | .880 (22.35)  | .940 (23.88)  | 15 | 16 | .750 (19.05) | .800 (20.32) |
| 37   | 1.475 (37.47) | 1.265 (32.13) | 1.088 (27.64) | 1.030 (26.16) | 1.090 (27.69) | 18 | 19 | .900 (22.86) | .950 (24.13) |

Dimensions in inches (mm)

# Micro D Series Filtered Connectors

| Size      | A                | B                | C (RCPT)         | C (Plug)         | D                |
|-----------|------------------|------------------|------------------|------------------|------------------|
| <b>9</b>  | .775<br>(19.69)  | .565<br>(14.35)  | .388<br>(9.86)   | .330<br>(8.38)   | .390<br>(9.91)   |
| <b>15</b> | .925<br>(23.50)  | .715<br>(18.16)  | .538<br>(13.67)  | .480<br>(12.19)  | .540<br>(13.72)  |
| <b>21</b> | 1.075<br>(27.31) | .865<br>(21.97)  | .688<br>(17.48)  | .630<br>(16.00)  | .690<br>(17.53)  |
| <b>25</b> | 1.175<br>(29.85) | .965<br>(24.51)  | .788<br>(20.02)  | .730<br>(18.54)  | .790<br>(20.07)  |
| <b>31</b> | 1.325<br>(33.66) | 1.115<br>(28.32) | .938<br>(23.83)  | .880<br>(22.35)  | .940<br>(23.88)  |
| <b>37</b> | 1.475<br>(37.47) | 1.265<br>(32.13) | 1.088<br>(27.64) | 1.030<br>(26.16) | 1.090<br>(27.69) |

Dimensions in inches (mm)

## Vertical PCB

### Receptacle



### Plug



## Solder Cup

### Receptacle



### Plug

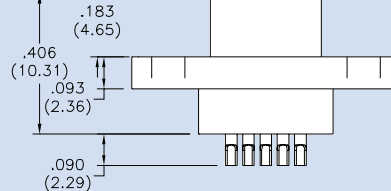

# Micro D Series Filtered Connectors Options

**JP - #2-56 Jack Post** M83513/05-07



**JS - #2-56 Jack Screw** M83513/05-05



**TI - Threaded Insert** Receptacle



**TI - Threaded Insert** Plug



**GB - Ground Bracket** Receptacle



**GB - Ground Bracket** Plug



# Micro D Series Filtered Connectors Board and Panel Cutouts

## Vertical PCB Layouts

Pin Connector Shown

### 9 Contacts



### 15 Contacts



### 21 Contacts



### 25 Contacts



### 31 Contacts



### 37 Contacts



## Right Angle PCB Layouts

Pin Connector Shown

### 9 Contacts



### 15 Contacts



### 21 Contacts



### 25 Contacts



### 31 Contacts



### 37 Contacts



Notes: PC Tail Diameter 0.018 ±0.002 (0.46 ±0.05) Contact numbers shown are pin connector.  
Reverse for socket. Patterns shown are for connector mounting side of PC board.



# Filtered Miniature Ribbon Connectors 50 Position



| Part Number | Capacitance Value |
|-------------|-------------------|
| 56-882-002  | 100 pF, ±20%      |
| 56-882-003  | 220 pF, ±20%      |
| 56-882-004  | 470 pF, ±20%      |
| 56-882-005  | 820 pF, ±20%      |

# Filtered Miniature Ribbon Connectors 50 Position



| Part Number | Capacitance Value |
|-------------|-------------------|
| 56-886-002  | 100 pF, ±20%      |
| 56-886-003  | 220 pF, ±20%      |
| 56-886-004  | 470 pF, ±20%      |
| 56-886-005  | 820 pF, ±20%      |



# Filtered Miniature Ribbon Connectors 50 Position

## Adapter



Dimensions in inches (mm)

| Part Number | Capacitance Value |
|-------------|-------------------|
| 56-889-002  | 100 pF ±15%       |
| 56-889-003  | 220 pF ±15%       |
| 56-889-004  | 470 pF ±15%       |
| 56-889-005  | 820 pF ±15%       |

Hardware options also available. Consult factory for more information.

## Filtered Modular Jack Connectors

Protecting signals from electromagnetic interference (EMI) is now more important than ever. API's Spectrum Control brand gives you more choices in keeping your signals clean and free of EMI. Whatever the level of protection your application requires, we offer signal conditioning products that meet varied levels of price and performance.

These compact, low-cost, filtered printed circuit board RJ45 modular jack connectors from API's Spectrum Control brand offers an inexpensive way to protect equipment from conducted and radiated electromagnetic interference (EMI), while meeting all appropriate performance requirements. Offering compact size and high reliability, these new connectors are fully intermateable and interchangeable with existing standard products. The low profile and narrow width of the multi-port style allows more ports to be packed into less space.

Filtered versions can be supplied in shielded or unshielded versions. Redundant shielding tabs ensure that a low impedance ground path is maintained across the interface. These flame retardant polyester thermoplastic connectors are compatible with wave solder environments, and utilize duplex plated contacts with solder tails.

Modular jack connectors assist with FCC Part 15 A & B; and CISPR 22 compliance.

Applications for this type of connector are widely diversified and include: LANs, WANs, network cards, broadband transmission equipment, workstations, peripherals, fax/modems, copy machines and multiplexing.

### Features

- RoHS compliant
- Lower installed cost
- Assists with FCC Part 15 A & B; and CISPR 22 compliance
- Drop-in replacement, matched footprint
- All circuit lines protected
- Inductor, capacitor or ESD versions
- Unshielded or shielded versions
- Select lead versions available
- High temperature versions available for reflow processes



### Typical Impedance vs. Frequency (Ferrite Version)



### Typical Time Voltage Curves (ESD Version)



Typical Time-Voltage Curve of Transient Spike on Integrated Protected Connector with Capacitance (Parts with Working Voltage Code starting with 0)

# Rugged USB Connectors

New rugged USB Connectors from API's Spectrum Control brand feature a heavy-duty design able to connect to USB 2.0 or 1.1 ports, making them ideal for demanding, high stress applications.

## Product Highlights

- Connectors meet seal requirements of IEC-60529, Code IP67 on PCB side
- Meet immersion requirements per MIL-STD-810F, Method 512.4 to 20 meters (unmated)
- RoHS compliant
- Supplied with gasket
- Ideal for demanding applications in the military, communications, medical, industrial and computing industries
- Type A, right-angle mounted connector
- USB 2.0 or 1.1 applications
- Part Number: 56FU04-017



## Electrical Specifications

Operating Temperature . . -40°C to +105°C

Current Rating . . . . . 1.5 Amps

Contact Resistance . . . . . 30 mΩ

## Dimensions



## Hooded Strain Reliefs

Hooded strain reliefs are used whenever a connector is used on a cable assembly which will be exposed to users and subject to multiple disconnects. Hoods are designed to protect users from shock hazard by exposed solder joints, as well as provide a strain relief for the wires and protection against accidental short circuits.

Since most filter connectors are larger than standard connectors, there had been a problem fitting most commercially available hoods. Spectrum Control solves this problem. Our hoods are molded of thin wall plastic, providing extra internal space to accommodate larger filter connectors. The hood is constructed of extremely durable polycarbonate and meets the flammability requirements for UL94V-0.

In addition, hoods are ideal for use on applications which require the use of extra components such as resistors or varistors on the wires. The nonconductive hood conveniently houses the connector, components, and protects any joints.

- **2560-9000-XX** is supplied with metal retention clips to hold the connector within the hood assembly. This item is recommended for use with Spectrum Filtered D-sub's, most other filtered D-sub's, and most standard D-sub's.
- **2560-9001-XX** is meant to be used with a connector which has a special eyelet on the mounting flange. This feature is available as an option on the Spectrum Filtered D-sub. Contact factory for additional information.



## Ordering Information and Dimensions

| Part Number                  | Connector Size | A ±.005          | B Max            | C Max            | D Max            | E Max           | F Max           |
|------------------------------|----------------|------------------|------------------|------------------|------------------|-----------------|-----------------|
| 2560-9000-01<br>2560-9001-01 | 9              | 0.984<br>(24.99) | 1.228<br>(31.19) | 1.710<br>(43.43) | 0.985<br>(25.02) | .685<br>(17.40) | .240<br>(6.07)  |
| 2560-9000-02<br>2560-9001-02 | 15             | 1.312<br>(33.33) | 1.556<br>(39.52) | 1.710<br>(43.43) | 1.310<br>(26.71) | .685<br>(17.40) | .300<br>(7.62)  |
| 2560-9000-03<br>2560-9001-03 | 25             | 1.852<br>(47.04) | 2.103<br>(53.42) | 1.710<br>(43.43) | 1.850<br>(46.99) | .685<br>(17.40) | .400<br>(10.16) |
| 2560-9000-04<br>2560-9001-04 | 37             | 2.500<br>(63.50) | 2.744<br>(69.70) | 1.710<br>(43.43) | 2.500<br>(63.50) | .685<br>(17.40) | .400<br>(10.16) |

Dimensions in inches (mm)

# Custom Engineered Solutions

Despite the breadth of our filtered connector product line, there exist certain applications which demand a custom EMC solution. Our engineering staff will work with your design team to provide a custom filtered connector which meets your individual requirements. Examples of custom projects are shown below.

## Special Mounting Flanges

- Housings can be designed to be integrated into the customer's equipment. The housings are constructed of machined materials, or precision diecast zinc.

## Value-added Assemblies

- API's capabilities extend beyond just supplying filter connectors. Additional operations such as sourcing and assembling flexible circuits, adding flying leads, or making connector to connector assemblies, all can be provided in conjunction with the filter connector.

## Custom Filter Arrangements

- Complex filters involving unbalanced Pi types, LC types with large inductive components, special pin-in to pin-out translations, and overvoltage protective devices such as diodes and varistors can be packaged within the connector.

## Other Connector Formats

- Manufacturer specific connectors also can be filtered. Our involvement ranges from complete design to implementing minor modifications to include the addition of the filter components. Medical equipment and hand-held devices are examples of excellent applications for these connectors.



Special Mounting Flanges & Value-added



Custom Filter Arrangements & Connectors



VDE RS232 connector

Tempest VGA connector adapter

FCC VGA connector adapter

# Filtered Connector Performance Specifications

The filtered D-subminiature connectors shown in this catalog have been designed and tested to the following test plan.

The information shown can be used as a basis for your filtered connector specifications. (Contact API for additional details.)

| Test Group | Order of Test   | Examination of Test                             | Test Method   | Post Test Requirements  |
|------------|---|---|---|---|
| I          | 1   | Visual and Mechanical Examination               |   | In accordance with applicable requirements.   |
|            | 2   | Materials, Designs Construction and Workmanship |   |   |
|            | 3   | Physical Dimensions and Marking                 |   |   |
|            | 4   | Capacitance                                     | MIL-STD-202<br>Method 305 1 KHz, 1VRMS max. 25°C  | Within specified tolerance.   |
|            | 5   | Dielectric Withstanding Voltage                 | MIL-STD-202<br>Method 301   | No breakdown or damage.   |
|            | 6   | Insulation Resistance                           | MIL-STD-202<br>Method 302, test condition at rated voltage  | 5000 megohm minimum.  |
|            | 7   | Insertion Loss                                  | MIL-STD-220<br>No load  | In accordance with applicable requirements.   |
| II         | 1   | Contact Engagement and Separation               | MIL-C-24308, Para. 3.5.10   | Maximum engagement force 18.0 oz., minimum separation force 0.7 oz.   |
|            | 2   | Mating and Unmating Force                       | MIL-C-24308, Para. 3.5.4  | MIL-C-24308, Para. 3.5.4<br>Table II<br>Limits: Shell size 1-5, class G only.                               |
|            | 3   | Durability                                      | MIL-C-24308, Para. 3.5.16, 4.7.18, except 100 cycles  | MIL-C-24308, Para. 3.5.9<br>Contact resistance at 1 amp. 20 millohms max.                                   |
|            | 4   | Thermal Shock                                   | MIL-STD-202<br>Method 107, Test condition B, -55°C to +125°C  | No evidence of damage.<br>Insulation resistance not less than 2500 megohms.                                 |
|            | 5   | Solderability                                   | MIL-STD-202; Method 208, RMA-Flux   | Terminals shall meet solderability requirements.  |
|            | 6   | Moisture Resistance                             | MIL-STD-202<br>Method 106, less step seven  | Insulation resistance not less than 500 megohms.<br>Meet dielectric withstanding voltage requirements.      |
|            | 7   | Resistance to Soldering Heat                    | MIL-STD-202<br>Method 210, Test condition D   | Insulation resistance not less than 500 megohms.<br>Meet dielectric withstanding voltage requirements.      |
| III        | 1   | Vibration                                       | MIL-STD-202<br>Method 204, Test condition D, 100 mA, current  | No interruption of current flow longer than 1 microsecond. Insulation resistance greater than 5000 megohms. |
|            | 2   | Shock   | MIL-STD-202<br>Method 213.<br>Test Condition G,<br>100 mA, current  | No interruptions of current flow longer than 1 microsecond.   |
|            |   |   |   | Contact resistance at 1 amp. 15 millohms max.   |
|            |   |   |   | Capacitance within specified limits.  |
| 3          | Mounting Inserts<br>a. Prevailing torque (locking)<br>b. Installation torque (locking)<br>c. Push-out Force | IFI-100   | a. 3 inch-pounds max.<br>b. 6 inch-pounds without damage<br>c. 10 pounds axial force without loosening insert   |   |
| IV         | 1   | Life  | MIL-STD-202<br>Method 108, Test condition D, within 125% of rated voltage at the maximum operating temperature. | Filter shall meet all initial requirements except insulation resistance shall not be less than 500 megohms. |

# Board & Panel Cutouts



Printed Circuit  
Vertical Board Mount (standard density)



Printed Circuit  
Right Angle Mount (standard density)

## Board Layout (Pin and Socket Contact) for Standard D-Sub Connectors

| Shell Size | A                | B   | C  | D                | E              | F              | G                                    | H              | I (Dia.)       | J              |
|------------|------------------|---|--|------------------|----------------|----------------|--------------------------------------|----------------|----------------|----------------|
| 9 (0)      | .984<br>(25.00)  | .436 = 4 x .109<br>(11.07) (2.77)             | .327 = 3 x .109<br>(8.31) (2.77)             | .492<br>(12.50)  |                |                | PCB Mount<br>.056 (1.42)             |                |                |                |
| 15 (1)     | 1.312<br>(33.32) | .763 = 7 x .109<br>(19.38) (2.77)             | .654 = 6 x .109<br>(16.61) (2.77)            | .656<br>(16.66)  |                |                | PCB Mount<br>Rt Angle<br>.275 (6.99) | .125<br>(3.18) | .045<br>(1.14) | .054<br>(1.37) |
| 25 (2)     | 1.852<br>(47.04) | 1.308 = 12 x .109<br>(33.22) (2.77)           | 1.199 = 11 x .109<br>(30.45) (2.77)          | .926<br>(23.52)  | .109<br>(2.77) | .112<br>(2.84) | 0.112<br>2 rows                      |                |                |                |
| 37 (3)     | 2.500<br>(63.50) | 1.962 = 18 x .109<br>(49.83) (2.77)           | 1.853 = 17 x .109<br>(47.07) (2.77)          | 1.250<br>(31.75) |                |                |                                      |                |                |                |
| 50 (4)     | 2.406<br>(61.11) | 1.744 = 16 x .109<br>(44.30) (2.77)<br>2 rows | 1.635 = 15 x .109<br>(41.35) (2.77)<br>1 row | 1.203<br>(30.56) |                |                | 0.00<br>1 row                        |                |                |                |

## Panel Cutouts (Front or Rear Mounting) for Standard and High-Density D-Sub Connectors

| Shell Size | A<br>±.015<br>(.38) | B<br>±.015<br>(.38) | C<br>±.015<br>(.38) | D<br>±.015<br>(.38) | E<br>±.003<br>(.08) | F<br>±.005<br>(.13) | G<br>±.002<br>(.05) | Panel Cutouts        |
|------------|---------------------|---------------------|---------------------|---------------------|---------------------|---------------------|---------------------|----------------------|
| 9 (0)      | .984<br>(24.99)     | .492<br>(12.49)     | .777<br>(19.74)     | .388<br>(9.87)      | .440<br>(11.18)     | .220<br>(5.59)      | .150<br>(3.81)      | <p>Panel Cutouts</p> |
| 15 (1)     | 1.312<br>(33.32)    | .656<br>(16.66)     | 1.105<br>(28.07)    | .552<br>(14.03)     | .440<br>(11.18)     | .220<br>(5.59)      | .150<br>(3.81)      |                      |
| 25 (2)     | 1.852<br>(47.04)    | .926<br>(23.52)     | 1.645<br>(41.78)    | .822<br>(20.89)     | .440<br>(11.18)     | .220<br>(5.59)      | .150<br>(3.81)      |                      |
| 37 (3)     | 2.500<br>(63.50)    | 1.250<br>(31.75)    | 2.293<br>(58.24)    | 1.146<br>(29.12)    | .440<br>(11.18)     | .220<br>(5.59)      | .150<br>(3.81)      |                      |
| 50 (4)     | 2.406<br>(61.11)    | 1.203<br>(30.55)    | 2.190<br>(55.63)    | 1.095<br>(27.81)    | .550<br>(13.97)     | .275<br>(6.98)      | .150<br>(3.81)      |                      |

Dimensions in inches (mm)

# Board & Panel Cutouts

**15 High-Density Pin/PCB**



**15 High-Density Socket/Right Angle**



**26 High-Density Pin/PCB**



**26 High-Density Socket/PCB**



**44 High-Density Pin/PCB**



**44 High-Density Socket/PCB**

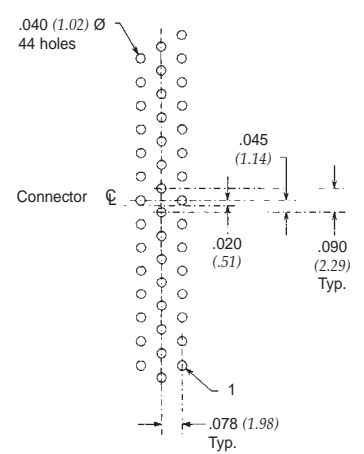

**62 High-Density Pin/PCB**



**62 High-Density Socket/PCB**



**78 High-Density Socket/PCB Pin/PCB**



Dimensions in inches (mm)



Компания «Океан Электроники» предлагает заключение долгосрочных отношений при поставках импортных электронных компонентов на взаимовыгодных условиях!

Наши преимущества:

- Поставка оригинальных импортных электронных компонентов напрямую с производств Америки, Европы и Азии, а так же с крупнейших складов мира;
- Широкая линейка поставок активных и пассивных импортных электронных компонентов (более 30 млн. наименований);
- Поставка сложных, дефицитных, либо снятых с производства позиций;
- Оперативные сроки поставки под заказ (от 5 рабочих дней);
- Экспресс доставка в любую точку России;
- Помощь Конструкторского Отдела и консультации квалифицированных инженеров;
- Техническая поддержка проекта, помощь в подборе аналогов, поставка прототипов;
- Поставка электронных компонентов под контролем ВП;
- Система менеджмента качества сертифицирована по Международному стандарту ISO 9001;
- При необходимости вся продукция военного и аэрокосмического назначения проходит испытания и сертификацию в лаборатории (по согласованию с заказчиком);
- Поставка специализированных компонентов военного и аэрокосмического уровня качества (Xilinx, Altera, Analog Devices, Intersil, Interpoint, Microsemi, Actel, Aeroflex, Peregrine, VPT, Syfer, Eurofarad, Texas Instruments, MS Kennedy, Miteq, Cobham, E2V, MA-COM, Hittite, Mini-Circuits, General Dynamics и др.);

Компания «Океан Электроники» является официальным дистрибьютором и эксклюзивным представителем в России одного из крупнейших производителей разъемов военного и аэрокосмического назначения «JONHON», а так же официальным дистрибьютором и эксклюзивным представителем в России производителя высокотехнологичных и надежных решений для передачи СВЧ сигналов «FORSTAR».



## JONHON

«JONHON» (основан в 1970 г.)

Разъемы специального, военного и аэрокосмического назначения:

(Применяются в военной, авиационной, аэрокосмической, морской, железнодорожной, горно- и нефтедобывающей отраслях промышленности)

«FORSTAR» (основан в 1998 г.)

ВЧ соединители, коаксиальные кабели, кабельные сборки и микроволновые компоненты:

(Применяются в телекоммуникациях гражданского и специального назначения, в средствах связи, РЛС, а так же военной, авиационной и аэрокосмической отраслях промышленности).



Телефон: 8 (812) 309-75-97 (многоканальный)

Факс: 8 (812) 320-03-32

Электронная почта: [ocean@oceanchips.ru](mailto:ocean@oceanchips.ru)

Web: <http://oceanchips.ru/>

Адрес: 198099, г. Санкт-Петербург, ул. Калинина, д. 2, корп. 4, лит. А