

# MCL1608V1

## Multilayer chip inductor



### Product features

- 0603 (1608 metric) package
- Low DC resistance, high current
- Multilayer monolithic construction yields high reliability
- Suitable for wave and reflow soldering
- Inductance range from 0.047 uH to 12 uH
- Moisture sensitivity level (MSL): 1

### Applications

- Industrial connectivity (IoT)
- Wireless communications
  - Bluetooth
  - WiFi
  - Antenna
- Machine-to-machine (M2M)
- Mobile phones
- Wearable devices
- Wireless LAN
- Computing/gaming consoles
- Broadband components
- RF transceiver modules

### Environmental data

- Operating temperature range: -40 °C to +85 °C (ambient plus self-temperature rise)
- Solder reflow temperature: J-STD-020 (latest revision) compliant



**Product specifications**

Part number	OCL (uH) ±20%	I Rated (mA) maximum	DCR (Ω) maximum @ +25°C	SRF (MHz) minimum	Test frequency (MHz)	Test voltage (mV)
MCL1608V1-R047-R	0.047	150	0.12	260	1.0	50
MCL1608V1-R056-R	0.056	150	0.12	260	1.0	50
MCL1608V1-R068-R	0.068	150	0.12	250	1.0	50
MCL1608V1-R082-R	0.082	150	0.12	245	1.0	50
MCL1608V1-R10-R	0.100	150	0.15	240	1.0	50
MCL1608V1-R12-R	0.120	150	0.20	205	1.0	50
MCL1608V1-R15-R	0.150	150	0.20	180	1.0	50
MCL1608V1-R18-R	0.180	150	0.20	165	1.0	50
MCL1608V1-R22-R	0.220	150	0.25	150	1.0	50
MCL1608V1-R27-R	0.270	100	0.30	136	1.0	50
MCL1608V1-R33-R	0.330	100	0.30	125	1.0	50
MCL1608V1-R39-R	0.390	100	0.35	110	1.0	50
MCL1608V1-R47-R	0.470	100	0.45	105	1.0	50
MCL1608V1-R56-R	0.560	100	0.45	95	1.0	50
MCL1608V1-R68-R	0.680	100	0.55	90	1.0	50
MCL1608V1-R82-R	0.820	100	0.60	85	1.0	50
MCL1608V1-1R0-R	1.0	150	0.30	75	1.0	50
MCL1608V1-1R2-R	1.2	150	0.30	65	1.0	50
MCL1608V1-1R5-R	1.5	120	0.35	60	1.0	50
MCL1608V1-1R8-R	1.8	120	0.40	55	1.0	50
MCL1608V1-2R2-R	2.2	120	0.50	50	1.0	50
MCL1608V1-2R7-R	2.7	100	0.60	45	1.0	50
MCL1608V1-3R3-R	3.3	100	0.65	40	1.0	50
MCL1608V1-3R9-R	3.9	80	0.70	35	1.0	50
MCL1608V1-4R7-R	4.7	80	0.75	33	1.0	50
MCL1608V1-5R6-R	5.6	60	0.90	22	1.0	50
MCL1608V1-6R8-R	6.8	60	0.90	20	1.0	50
MCL1608V1-8R2-R	8.2	60	1.05	18	1.0	50
MCL1608V1-100-R	10	60	1.15	17	1.0	50
MCL1608V1-120-R	12	60	1.25	15	1.0	50

1. Test frequency and voltage at +25 °C
2. Resistance to soldering heat: +260 ±5 °C for 10 ± 1 second
3. At low temperature (-40 ±2°C) the inductance change is within ±10%
4. At high temperature (+85 ±2°C) the inductance change is within ±10%

5. Rated I: When rated I is applied to the product, self-temperature rise will be 40 °C or less.
6. Part Number Definition: MCL1608V1-xxx-R  
MCL1608 = Product code and size  
V1= Version indicator  
xxx= inductance value in uH, R= decimal point,  
If no R is present then last character equals number of zeros  
-R suffix = RoHS compliant

Dimensions (mm)



Schematic



Part Number	L	W	T	a	A	B	C
MCL1608V1-xxx-R	1.6 ±0.20	0.80 ±0.20	0.80 ±0.20	0.30 ±0.20	1.2 ±0.10	0.9 ±0.10	0.40 ±0.10

No part marking  
All soldering surfaces to be coplanar within 0.1 millimeters  
Tolerances are ±0.2 millimeters unless stated otherwise  
Pad layout tolerances are ±0.1 millimeters unless stated otherwise  
Do not route traces or vias underneath the inductor

Packaging information (mm)

Drawing not to scale

Supplied in tape and reel packaging, 4000 parts per 7" diameter reel

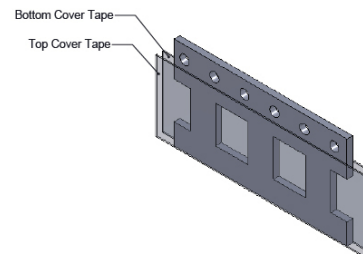
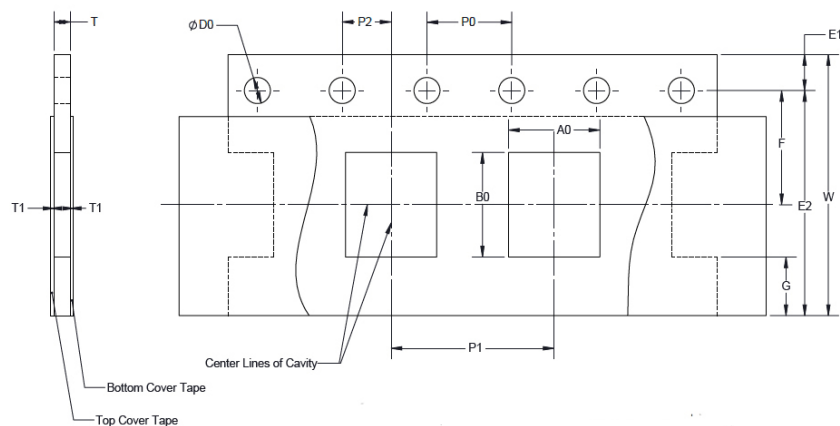

W ±0.3	8.00
F ±0.05	3.50
E1 ±0.10	1.75
E2 Min	6.25
P0 ±0.10	4.00
P1 ±0.20	4.00
P2 ±0.1	2.00
D0 +0.10/-0	1.50
A0	1.1 ±0.20
B0	1.9 ±0.20
T Max	1.10
T1 Max	na

**Inductance vs frequency**

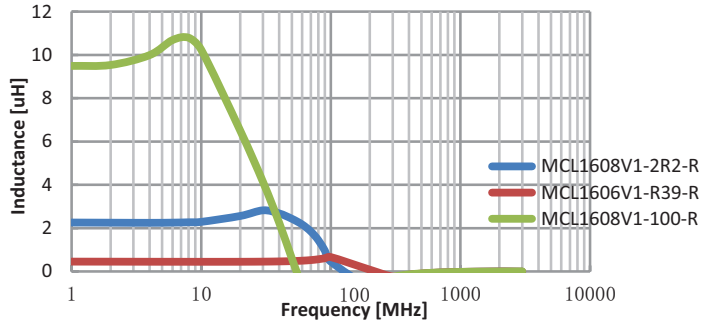

**Q vs frequency**

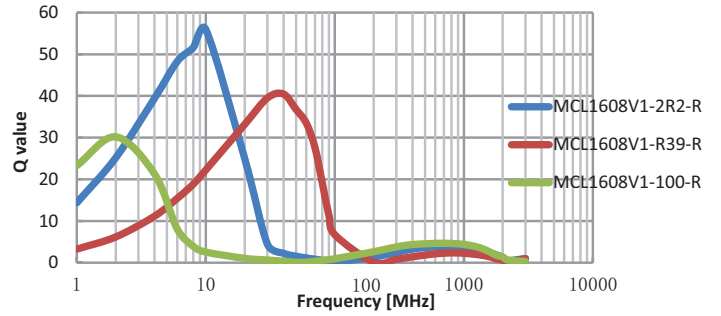

**Inductance vs current**

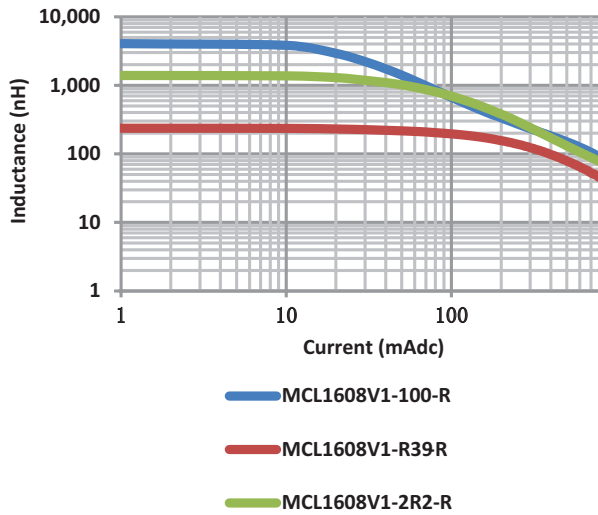

**Temperature rise vs current**

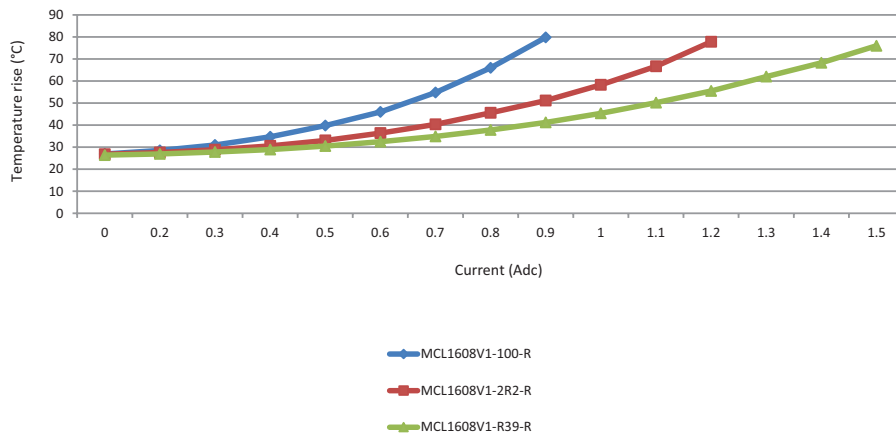

Solder reflow profile

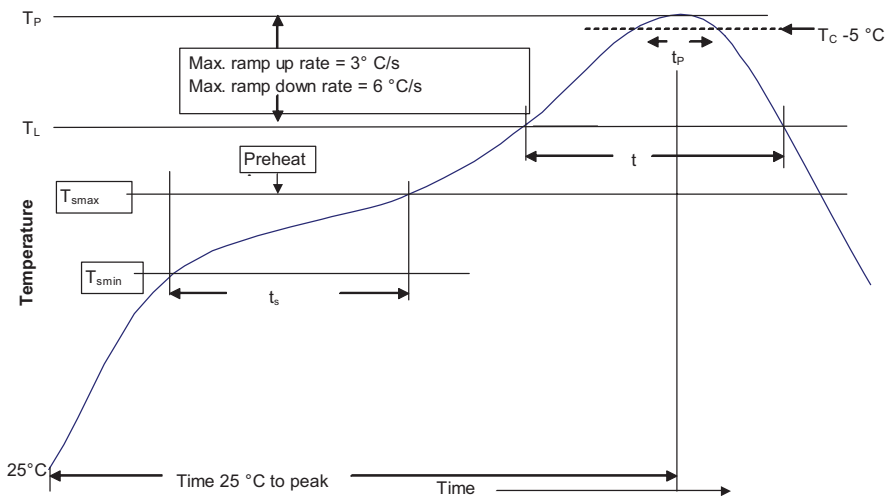

Table 1 - Standard SnPb solder ( $T_c$ )

Package Thickness	Volume mm <sup>3</sup> <350	Volume mm <sup>3</sup> ≥350
<2.5 mm)	235 °C	220 °C
≥2.5 mm	220 °C	220 °C

Table 2 - Lead (Pb) free solder ( $T_c$ )

Package thickness	Volume mm <sup>3</sup> <350	Volume mm <sup>3</sup> 350 - 2000	Volume mm <sup>3</sup> >2000
<1.6 mm	260 °C	260 °C	260 °C
1.6 – 2.5 mm	260 °C	250 °C	245 °C
>2.5 mm	250 °C	245 °C	245 °C

Reference J-STD-020

Profile feature	Standard SnPb solder	Lead (Pb) free solder
Preheat and soak		
• Temperature min. ( $T_{smin}$ )	100 °C	150 °C
• Temperature max. ( $T_{smax}$ )	150 °C	200 °C
• Time ( $T_{smin}$ to $T_{smax}$ ) ( $t_s$ )	60-120 seconds	60-120 seconds
Average ramp up rate $T_{smax}$ to $T_p$	3 °C/ second max.	3 °C/ second max.
Liquidous temperature ( $T_L$ )	183 °C	217 °C
Time at liquidous ( $t_L$ )	60-150 seconds	60-150 seconds
Peak package body temperature ( $T_p$ )*	Table 1	Table 2
Time ( $t_p$ )** within 5 °C of the specified classification temperature ( $T_c$ )	10 seconds**	10 seconds**
Average ramp-down rate ( $T_p$ to $T_{smax}$ )	6 °C/ second max.	6 °C/ second max.
Time 25 °C to peak temperature	6 minutes max.	8 minutes max.

\* Tolerance for peak profile temperature ( $T_p$ ) is defined as a supplier minimum and a user maximum.

\*\* Tolerance for time at peak profile temperature ( $t_p$ ) is defined as a supplier minimum and a user maximum.

### Wave solder profile



### Reference EN 61760-1:2006

Profile feature	Standard SnPb solder	Lead (Pb) free solder
Preheat		
• Temperature min. ( $T_{smin}$ )	100 °C	100 °C
• Temperature typ. ( $T_{styp}$ )	120 °C	120 °C
• Temperature max. ( $T_{smax}$ )	130 °C	130 °C
• Time ( $T_{smin}$ to $T_{smax}$ ) ( $t_s$ )	70 seconds	70 seconds
$\Delta$ preheat to max Temperature	150 °C max.	150 °C max.
Peak temperature ( $T_p$ )*	235 °C – 260 °C	250 °C – 260 °C
Time at peak temperature ( $t_p$ )	10 seconds max 5 seconds max each wave	10 seconds max 5 seconds max each wave
Ramp-down rate	~ 2 K/s min ~3.5 K/s typ ~5 K/s max	~ 2 K/s min ~3.5 K/s typ ~5 K/s max
Time 25 °C to 25 °C	4 minutes	4 minutes

### Manual solder

+350 °C, 4-5 seconds. (by soldering iron), generally manual, hand soldering is not recommended.

Life Support Policy: Eaton does not authorize the use of any of its products for use in life support devices or systems without the express written approval of an officer of the Company. Life support systems are devices which support or sustain life, and whose failure to perform, when properly used in accordance with instructions for use provided in the labeling, can be reasonably expected to result in significant injury to the user.

Eaton reserves the right, without notice, to change design or construction of any products and to discontinue or limit distribution of any products. Eaton also reserves the right to change or update, without notice, any technical information contained in this bulletin.

**Eaton**  
**Electronics Division**  
1000 Eaton Boulevard  
Cleveland, OH 44122  
United States  
[www.eaton.com/electronics](http://www.eaton.com/electronics)

© 2019 Eaton  
All Rights Reserved  
Printed in USA  
Publication No. 10926 BU-MC19058  
June 2019

Eaton is a registered trademark.

All other trademarks are property of their respective owners.

Follow us on social media to get the latest product and support information.



Компания «Океан Электроники» предлагает заключение долгосрочных отношений при поставках импортных электронных компонентов на взаимовыгодных условиях!

Наши преимущества:

- Поставка оригинальных импортных электронных компонентов напрямую с производств Америки, Европы и Азии, а так же с крупнейших складов мира;
- Широкая линейка поставок активных и пассивных импортных электронных компонентов (более 30 млн. наименований);
- Поставка сложных, дефицитных, либо снятых с производства позиций;
- Оперативные сроки поставки под заказ (от 5 рабочих дней);
- Экспресс доставка в любую точку России;
- Помощь Конструкторского Отдела и консультации квалифицированных инженеров;
- Техническая поддержка проекта, помощь в подборе аналогов, поставка прототипов;
- Поставка электронных компонентов под контролем ВП;
- Система менеджмента качества сертифицирована по Международному стандарту ISO 9001;
- При необходимости вся продукция военного и аэрокосмического назначения проходит испытания и сертификацию в лаборатории (по согласованию с заказчиком);
- Поставка специализированных компонентов военного и аэрокосмического уровня качества (Xilinx, Altera, Analog Devices, Intersil, Interpoint, Microsemi, Actel, Aeroflex, Peregrine, VPT, Syfer, Eurofarad, Texas Instruments, MS Kennedy, Miteq, Cobham, E2V, MA-COM, Hittite, Mini-Circuits, General Dynamics и др.);

Компания «Океан Электроники» является официальным дистрибьютором и эксклюзивным представителем в России одного из крупнейших производителей разъемов военного и аэрокосмического назначения «JONHON», а так же официальным дистрибьютором и эксклюзивным представителем в России производителя высокотехнологичных и надежных решений для передачи СВЧ сигналов «FORSTAR».



## JONHON

«JONHON» (основан в 1970 г.)

Разъемы специального, военного и аэрокосмического назначения:

(Применяются в военной, авиационной, аэрокосмической, морской, железнодорожной, горно- и нефтедобывающей отраслях промышленности)

«FORSTAR» (основан в 1998 г.)

ВЧ соединители, коаксиальные кабели, кабельные сборки и микроволновые компоненты:

(Применяются в телекоммуникациях гражданского и специального назначения, в средствах связи, РЛС, а так же военной, авиационной и аэрокосмической отраслях промышленности).



Телефон: 8 (812) 309-75-97 (многоканальный)

Факс: 8 (812) 320-03-32

Электронная почта: [ocean@oceanchips.ru](mailto:ocean@oceanchips.ru)

Web: <http://oceanchips.ru/>

Адрес: 198099, г. Санкт-Петербург, ул. Калинина, д. 2, корп. 4, лит. А