



Power Silicon Rectifier Diodes, 35 A/40 A/60 A



DESCRIPTION/FEATURES

- Low leakage current series
- Good surge current capability up to 1000 A
- Can be supplied to meet stringent military, aerospace and other high reliability requirements
- Compliant to RoHS directive 2002/95/EC



RoHS
COMPLIANT

PRODUCT SUMMARY

$I_{F(AV)}$	35 A/40 A/60 A
-------------	----------------

MAJOR RATINGS AND CHARACTERISTICS

PARAMETER	TEST CONDITIONS	1N1183	1N3765	1N1183A	1N2128A	UNITS
$I_{F(AV)}$		35 ⁽¹⁾	35 ⁽¹⁾	40 ⁽¹⁾	60 ⁽¹⁾	A
	T_C	140 ⁽¹⁾	140 ⁽¹⁾	150 ⁽¹⁾	140 ⁽¹⁾	°C
I_{FSM}	50 Hz	480	380	765	860	A
	60 Hz	500 ⁽¹⁾	400 ⁽¹⁾	800 ⁽¹⁾	900 ⁽¹⁾	
I^2t	50 Hz	1140	730	2900	3700	A ² s
	60 Hz	1040	670	2650	3400	
$I^2\sqrt{t}$		16 100	10 300	41 000	52 500	A ² √s
V_{RRM}	Range	50 to 600 ⁽¹⁾	700 to 1000 ⁽¹⁾	50 to 600 ⁽¹⁾	50 to 600 ⁽¹⁾	V

Note

⁽¹⁾ JEDEC registered values

ELECTRICAL SPECIFICATIONS

VOLTAGE RATINGS

TYPE NUMBER			V_{RRM} , MAXIMUM REPETITIVE PEAK REVERSE VOLTAGE ($T_J = -65\text{ °C TO }200\text{ °C}^{(2)}$) V	V_{RM} , MAXIMUM DIRECT REVERSE VOLTAGE ($T_J = -65\text{ °C TO }200\text{ °C}^{(2)}$) V
1N1183	1N1183A	1N2128A	50 ⁽¹⁾	50 ⁽¹⁾
1N1184	1N1184A	1N2129A	100 ⁽¹⁾	100 ⁽¹⁾
1N1185	1N1185A	1N2130A	150 ⁽¹⁾	150 ⁽¹⁾
1N1186	1N1186A	1N2131A	200 ⁽¹⁾	200 ⁽¹⁾
1N1187	1N1187A	1N2133A	300 ⁽¹⁾	300 ⁽¹⁾
1N1188	1N1188A	1N2135A	400 ⁽¹⁾	400 ⁽¹⁾
1N1189	1N1189A	1N2137A	500 ⁽¹⁾	500 ⁽¹⁾
1N1190	1N1190A	1N2138A	600 ⁽¹⁾	600 ⁽¹⁾
1N3765			700 ⁽¹⁾	700 ⁽¹⁾
1N3766			800 ⁽¹⁾	800 ⁽¹⁾
1N3767			900 ⁽¹⁾	900 ⁽¹⁾
1N3768			1000 ⁽¹⁾	1000 ⁽¹⁾

Notes

⁽¹⁾ JEDEC registered values

⁽²⁾ For 1N1183 Series and 1N3765 Series $T_C = -65\text{ °C to }190\text{ °C}$

- Basic type number indicates cathode to case. For anode to case, add "R" to part number, e.g., 1N1188R, 1N3766R, 1N1186AR, 1N2135AR

1N1183, 1N3765, 1N1183A, 1N2128A Series



Vishay High Power Products Power Silicon Rectifier Diodes,
35 A/40 A/60 A

FORWARD CONDUCTION								
PARAMETER	SYMBOL	TEST CONDITIONS		1N1183	1N3765	1N1183A	1N2128A	UNITS
Maximum average forward current at case temperature	$I_{F(AV)}$	1-phase operation, 180° sinusoidal conduction		35 ⁽¹⁾	35 ⁽¹⁾	40 ⁽¹⁾	60 ⁽¹⁾	A
				140 ⁽¹⁾	140 ⁽¹⁾	150 ⁽¹⁾	140 ⁽¹⁾	°C
Maximum peak one cycle non-repetitive surge current	I_{FSM}	Half cycle 50 Hz sine wave or 6 ms rectangular pulse	Following any rated load condition and with rated V_{RRM} applied	480	380	765	860	A
		Half cycle 60 Hz sine wave or 5 ms rectangular pulse		500 ⁽¹⁾	400 ⁽¹⁾	800 ⁽¹⁾	900 ⁽¹⁾	
		Half cycle 50 Hz sine wave or 6 ms rectangular pulse	Following any rated load condition and with $\frac{1}{2} V_{RRM}$ applied following surge = 0	570	455	910	1000	
		Half cycle 60 Hz sine wave or 5 ms rectangular pulse		595	475	950	1050	
Maximum I^2t for fusing	I^2t	t = 10 ms	With rated V_{RRM} applied following surge, initial $T_J = T_J$ maximum	1140	730	2900	3700	A ² s
		t = 8.3 ms		1040	670	2650	3400	
Maximum I^2t for individual device fusing		t = 10 ms	With $V_{RRM} = 0$ following surge, initial $T_J = T_J$ maximum	1610	1030	4150	5250	
		t = 8.3 ms		1470	940	3750	4750	
Maximum $I^2\sqrt{t}$ for individual device fusing	$I^2\sqrt{t}$ ⁽²⁾	t = 0.1 to 10 ms, $V_{RRM} = 0$ following surge		16 100	10 300	41 500	52 500	A ² √s
Maximum peak forward voltage at maximum forward current (I_{FM})	V_{FM}	$T_J = 25$ °C		1.7 ⁽¹⁾	1.8 ⁽¹⁾	1.3 ⁽¹⁾	1.3 ⁽¹⁾	V
				110	110	126	188	A
Maximum average reverse current	$I_{R(AV)}$	Maximum rated $I_{F(AV)}$ and T_C		$V_{RRM} = 700$	5.0 ⁽¹⁾	-	-	mA
				$V_{RRM} = 800$	4.0 ⁽¹⁾	-	-	
				$V_{RRM} = 900$	3.0 ⁽¹⁾	-	-	
				$V_{RRM} = 1000$	2.0 ⁽¹⁾	-	-	
		Maximum rated $I_{F(AV)}$, V_{RRM} and T_C		10 ⁽¹⁾	-	2.5 ⁽¹⁾	10 ⁽¹⁾	

Notes

⁽¹⁾ JEDEC registered values

⁽²⁾ I^2t for time $t_x = I^2\sqrt{t} \times \sqrt{t_x}$



1N1183, 1N3765, 1N1183A, 1N2128A Series

Power Silicon Rectifier Diodes, Vishay High Power Products
35 A/40 A/60 A

THERMAL AND MECHANICAL SPECIFICATIONS							
PARAMETER	SYMBOL	TEST CONDITIONS	1N1183	1N3765	1N1183A	1N2128A	UNITS
Maximum operating case temperature range	T_C		- 65 to 190 ⁽¹⁾		- 65 to 200		°C
Maximum storage temperature range	T_{Stg}		- 65 to 175 ⁽¹⁾		- 65 to 200		
Maximum internal thermal resistance, junction to case	R_{thJC}	DC operation	1.00 ⁽¹⁾		1.1 ⁽¹⁾	0.65 ⁽¹⁾	°C/W
Thermal resistance, case to sink	R_{thCS}	Mounting surface, smooth, flat and greased	0.25				
Maximum allowable mounting torque (+ 0 %, - 10 %)		Not lubricated thread, tightening on nut ⁽²⁾	3.4 (30)				N · m (lbf · in)
		Lubricated thread, tightening on nut ⁽²⁾	2.3 (20)				
		Not lubricated thread, tightening on hexagon ⁽³⁾	4.2 (37)				
		Lubricated thread, tightening on hexagon ⁽³⁾	3.2 (28)				
Approximate weight			17				g
			0.6				oz.
Case style		JEDEC	DO-203AB (DO-5)				

Notes

- (1) JEDEC registered values
- (2) Recommended for pass-through holes
- (3) Recommended for holed threaded heatsinks

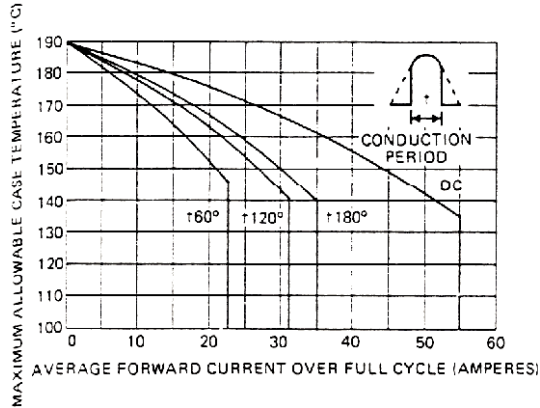

Fig. 1 - Maximum Allowable Case Temperature vs. Average Forward Current, 1N1183 and 1N3765 Series

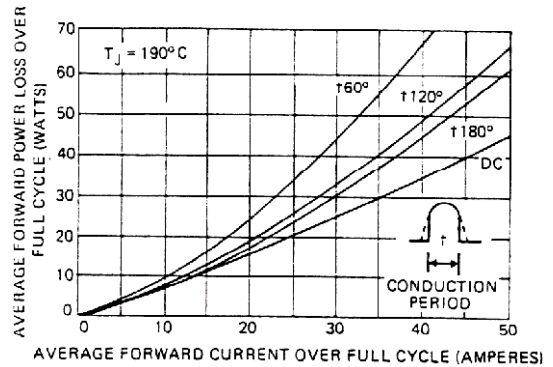

Fig. 2 - Typical Low Level Forward Power Loss vs. Average Forward Current (Sinusoidal Current Waveform), 1N1183 and 1N3765 Series

1N1183, 1N3765, 1N1183A, 1N2128A Series



Vishay High Power Products Power Silicon Rectifier Diodes,
35 A/40 A/60 A

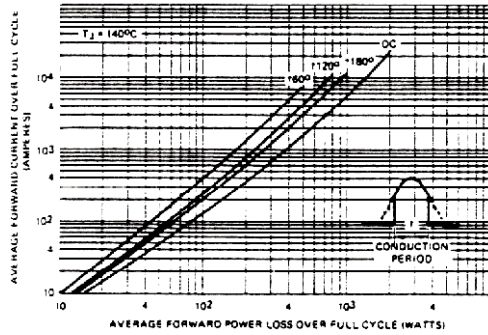

Fig. 3 - Typical High Level Forward Power Loss vs. Average Forward Current (Sinusoidal Current Waveform), 1N1183 and 1N3765 Series

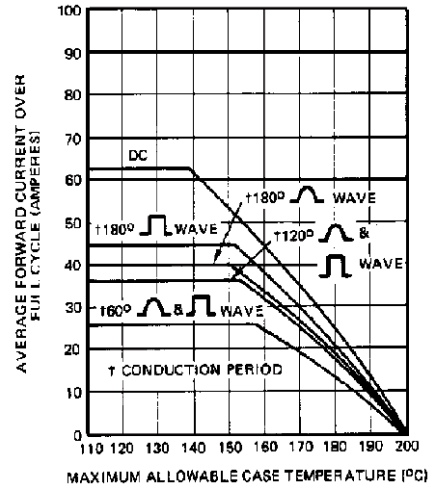

Fig. 6 - Average Forward Current vs. Maximum Allowable Case Temperature, 1N1183A Series

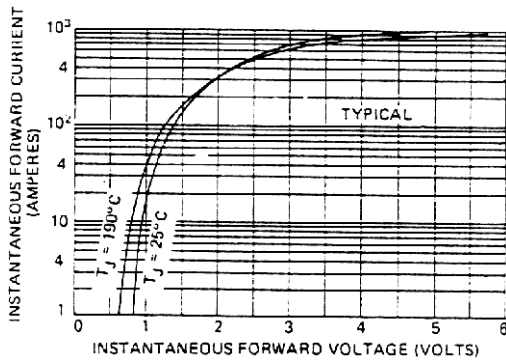

Fig. 4 - Typical Forward Voltage vs. Forward Current, 1N1183 and 1N3765 Series

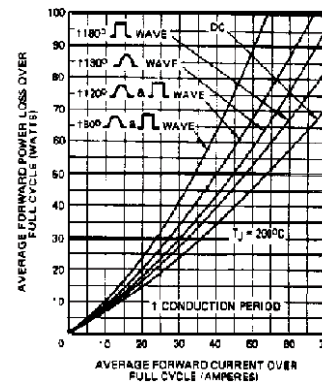

Fig. 7 - Maximum Low Level Forward Power Loss vs. Average Forward Current, 1N1183A Series

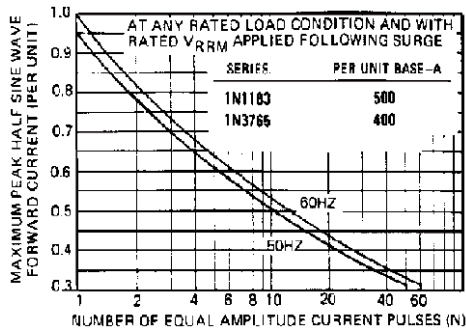

Fig. 5 - Maximum Non-Repetitive Surge Current vs. Number of Current Pulses, 1N1183 and 1N3765 Series

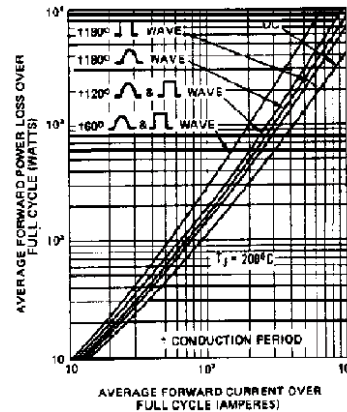

Fig. 8 - Maximum High Level Forward Power Loss vs. Average Forward Current, 1N1183A Series



1N1183, 1N3765, 1N1183A, 1N2128A Series

Power Silicon Rectifier Diodes, Vishay High Power Products
35 A/40 A/60 A

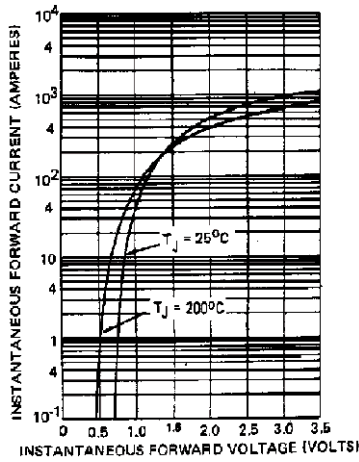

Fig. 9 - Maximum Forward Voltage vs. Forward Current, 1N1183A Series

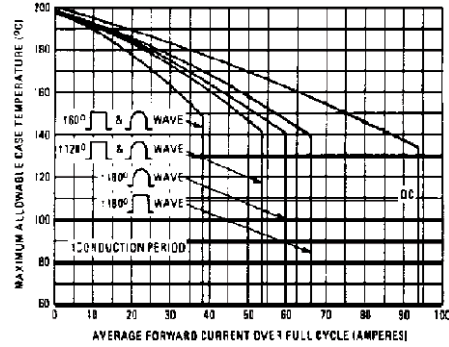

Fig. 12 - Maximum Allowable Case Temperature vs. Average Forward Current, 1N2128A Series

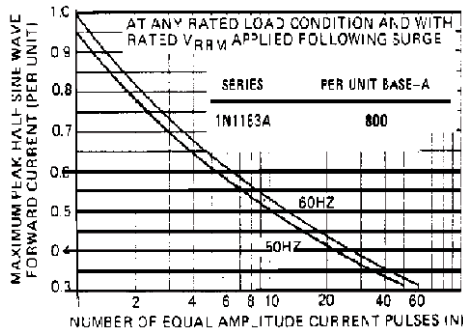

Fig. 10 - Maximum Non-Repetitive Surge Current vs. Number of Current Pulses, 1N1183A Series

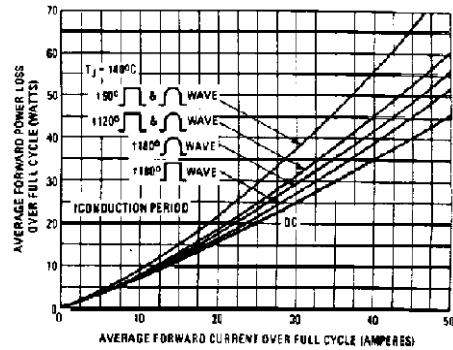

Fig. 13 - Maximum Low Level Forward Power Loss vs. Average Forward Current, 1N2128A Series

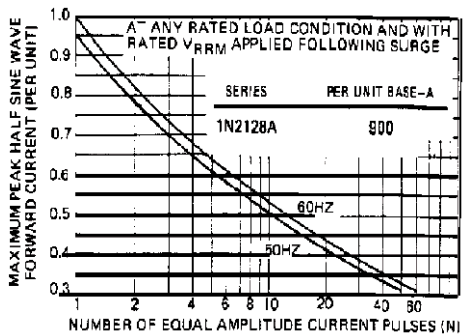

Fig. 11 - Maximum Non-Repetitive Surge Current vs. Number of Current Pulses, 1N2128A Series

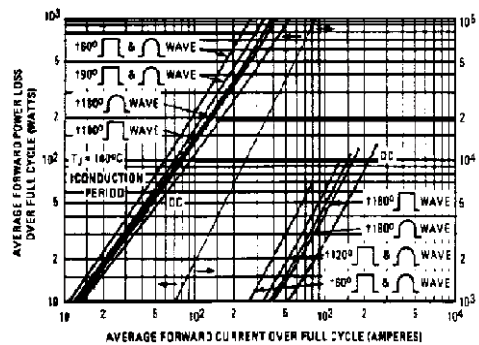

Fig. 14 - Maximum High Level Forward Power Loss vs. Average Forward Current, 1N2128A Series

1N1183, 1N3765, 1N1183A, 1N2128A Series

Vishay High Power Products Power Silicon Rectifier Diodes,
35 A/40 A/60 A

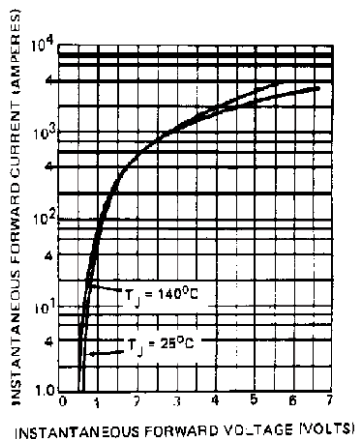
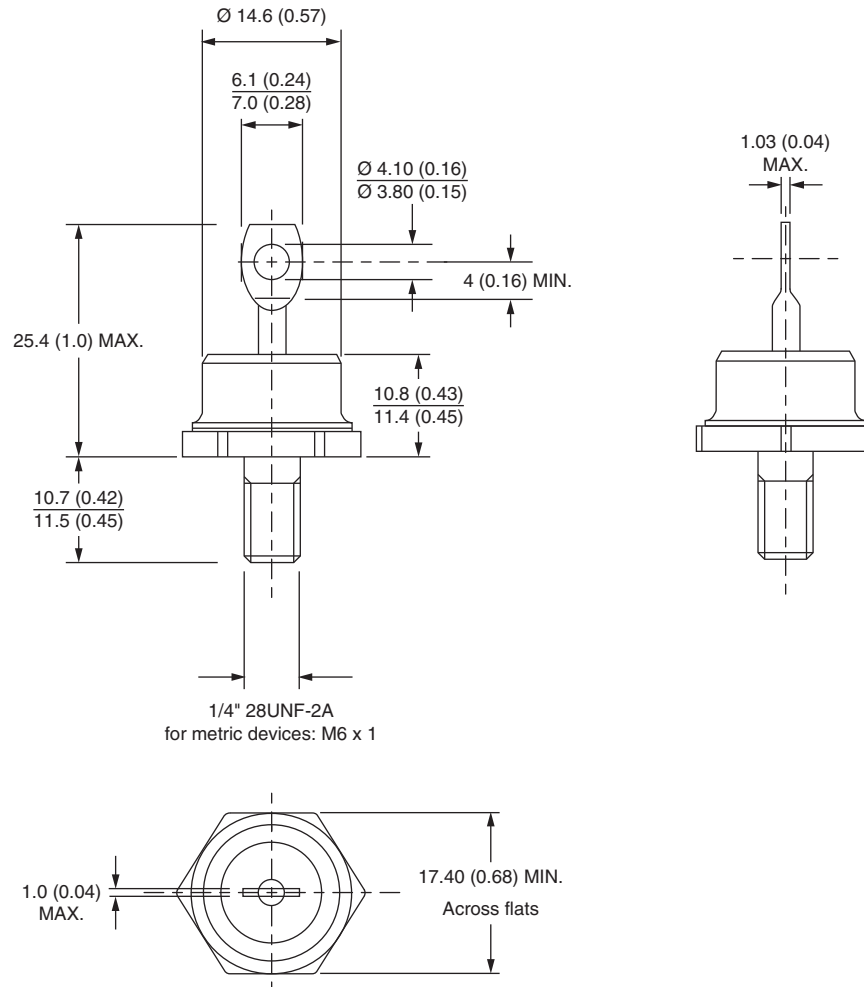

Fig. 15 - Maximum Forward Voltage vs. Forward Current, 1N2128A Series

LINKS TO RELATED DOCUMENTS	
Dimensions	www.vishay.com/doc?95360

DO-203AB (DO-5) for 1N1183, 1N3765, 1N1183A, 1N2128A, 1N3208 Series

DIMENSIONS in millimeters (inches)





Disclaimer

ALL PRODUCT, PRODUCT SPECIFICATIONS AND DATA ARE SUBJECT TO CHANGE WITHOUT NOTICE TO IMPROVE RELIABILITY, FUNCTION OR DESIGN OR OTHERWISE.

Vishay Intertechnology, Inc., its affiliates, agents, and employees, and all persons acting on its or their behalf (collectively, "Vishay"), disclaim any and all liability for any errors, inaccuracies or incompleteness contained in any datasheet or in any other disclosure relating to any product.

Vishay makes no warranty, representation or guarantee regarding the suitability of the products for any particular purpose or the continuing production of any product. To the maximum extent permitted by applicable law, Vishay disclaims (i) any and all liability arising out of the application or use of any product, (ii) any and all liability, including without limitation special, consequential or incidental damages, and (iii) any and all implied warranties, including warranties of fitness for particular purpose, non-infringement and merchantability.

Statements regarding the suitability of products for certain types of applications are based on Vishay's knowledge of typical requirements that are often placed on Vishay products in generic applications. Such statements are not binding statements about the suitability of products for a particular application. It is the customer's responsibility to validate that a particular product with the properties described in the product specification is suitable for use in a particular application. Parameters provided in datasheets and/or specifications may vary in different applications and performance may vary over time. All operating parameters, including typical parameters, must be validated for each customer application by the customer's technical experts. Product specifications do not expand or otherwise modify Vishay's terms and conditions of purchase, including but not limited to the warranty expressed therein.

Except as expressly indicated in writing, Vishay products are not designed for use in medical, life-saving, or life-sustaining applications or for any other application in which the failure of the Vishay product could result in personal injury or death. Customers using or selling Vishay products not expressly indicated for use in such applications do so at their own risk and agree to fully indemnify and hold Vishay and its distributors harmless from and against any and all claims, liabilities, expenses and damages arising or resulting in connection with such use or sale, including attorneys fees, even if such claim alleges that Vishay or its distributor was negligent regarding the design or manufacture of the part. Please contact authorized Vishay personnel to obtain written terms and conditions regarding products designed for such applications.

No license, express or implied, by estoppel or otherwise, to any intellectual property rights is granted by this document or by any conduct of Vishay. Product names and markings noted herein may be trademarks of their respective owners.

Material Category Policy

Vishay Intertechnology, Inc. hereby certifies that all its products that are identified as RoHS-Compliant fulfill the definitions and restrictions defined under Directive 2011/65/EU of The European Parliament and of the Council of June 8, 2011 on the restriction of the use of certain hazardous substances in electrical and electronic equipment (EEE) - recast, unless otherwise specified as non-compliant.

Please note that some Vishay documentation may still make reference to RoHS Directive 2002/95/EC. We confirm that all the products identified as being compliant to Directive 2002/95/EC conform to Directive 2011/65/EU.

Компания «Океан Электроники» предлагает заключение долгосрочных отношений при поставках импортных электронных компонентов на взаимовыгодных условиях!

Наши преимущества:

- Поставка оригинальных импортных электронных компонентов напрямую с производств Америки, Европы и Азии, а так же с крупнейших складов мира;
- Широкая линейка поставок активных и пассивных импортных электронных компонентов (более 30 млн. наименований);
- Поставка сложных, дефицитных, либо снятых с производства позиций;
- Оперативные сроки поставки под заказ (от 5 рабочих дней);
- Экспресс доставка в любую точку России;
- Помощь Конструкторского Отдела и консультации квалифицированных инженеров;
- Техническая поддержка проекта, помощь в подборе аналогов, поставка прототипов;
- Поставка электронных компонентов под контролем ВП;
- Система менеджмента качества сертифицирована по Международному стандарту ISO 9001;
- При необходимости вся продукция военного и аэрокосмического назначения проходит испытания и сертификацию в лаборатории (по согласованию с заказчиком);
- Поставка специализированных компонентов военного и аэрокосмического уровня качества (Xilinx, Altera, Analog Devices, Intersil, Interpoint, Microsemi, Actel, Aeroflex, Peregrine, VPT, Syfer, Eurofarad, Texas Instruments, MS Kennedy, Miteq, Cobham, E2V, MA-COM, Hittite, Mini-Circuits, General Dynamics и др.);

Компания «Океан Электроники» является официальным дистрибьютором и эксклюзивным представителем в России одного из крупнейших производителей разъемов военного и аэрокосмического назначения «JONHON», а так же официальным дистрибьютором и эксклюзивным представителем в России производителя высокотехнологичных и надежных решений для передачи СВЧ сигналов «FORSTAR».



JONHON

«JONHON» (основан в 1970 г.)

Разъемы специального, военного и аэрокосмического назначения:

(Применяются в военной, авиационной, аэрокосмической, морской, железнодорожной, горно- и нефтедобывающей отраслях промышленности)

«FORSTAR» (основан в 1998 г.)

ВЧ соединители, коаксиальные кабели, кабельные сборки и микроволновые компоненты:

(Применяются в телекоммуникациях гражданского и специального назначения, в средствах связи, РЛС, а так же военной, авиационной и аэрокосмической отраслях промышленности).



Телефон: 8 (812) 309-75-97 (многоканальный)

Факс: 8 (812) 320-03-32

Электронная почта: ocean@oceanchips.ru

Web: <http://oceanchips.ru/>

Адрес: 198099, г. Санкт-Петербург, ул. Калинина, д. 2, корп. 4, лит. А