

# BAND LOCK ADAPTOR



This is another method of termination of screens. A high quality band will do the job in this back shell. Tempered bands are tightened over the shields, which is pulled over the banding area, using special assembly tools. Suitable over cover by heat shrink boot or some other method as chosen by the designer could be used. Both crimp ring and banded terminations give a low DC resistance.

For Connector Group		Page No.
J	→	VII-1
K	→	VII-2
L	→	VII-3
M	→	VII-4
N	→	VII-5

**Note:** For Connector group Identification refer Table 1 - A, B, C, D (Page 7-11) and for Material / Plating Finish, Refer Table-2 (Page 12)



Connector Group - J

Straight, 90°, 45°

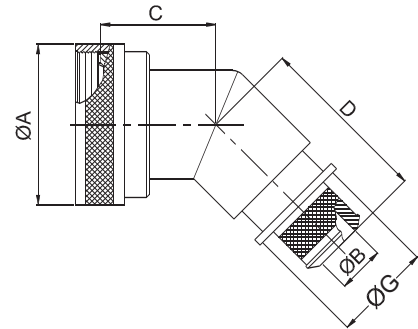

Amphenol Part Number

BL1 X X J 99 99 9 X X

Series — BL1  
 Angle — X X  
 S: straight  
 A: 90deg  
 B: 45deg  
 Coupling — J  
 R: spin  
 S: Self lock  
 Connector group — 99 99 9  
 Finish: see Table-2  
 B: With band  
 X: Without band  
 Length — 9  
 9 - for standard  
 Length in table / figure  
 Entry size — X X  
 See Table-A  
 Shell size — 99 99 9  
 See Table-A

MIL Part Number

M85049 / 99 - 99 X 9

MIL Series — M85049 / 99 - 99  
 Entry size: See Table-A  
 Finish: See Table-2  
 Shell size: See Table-A  
 Slash sheet — X 9  
 82 : Straight, self lock  
 84: 90deg, self lock  
 83: 45deg, self lock

NOTE: \* For more cable entry and length options, contact factory

TABLE - A

AMPHENOL PART NUMBER DESIGNATOR		MIL PART NUMBER DESIGNATOR		CONNECTOR SHELL SIZE	A DIA. (MAX)		B DIA.		C (MAX)		D (MAX)		E (MAX)		F (MAX)		G (MAX)	
SHELL SIZE	ENTRY SIZE	ACCESSORY SHELL SIZE	ENTRY SIZE		INCH	MM	+0.00	+0.00	INCH	MM	INCH	MM	INCH	MM	INCH	MM	INCH	MM
							-0.02	-0.50										
08	01	08	02	8	0.89	22.48	N/A	N/A	0.87	22.10	1.16	29.46	1.19	30.18	1.42	35.99	N/A	N/A
	02		03				0.26	6.60									0.56	14.22
10	01	10	02	10	1.01	25.65	N/A	N/A	0.89	22.61	1.18	29.97	1.28	32.54	1.48	37.59	N/A	N/A
	02		03				0.32	8.13									0.63	16.00
12	01	12	02	7 / 12	1.14	28.83	0.32	8.13	0.92	23.37	1.20	30.48	1.41	35.71	1.54	39.17	0.63	16.00
	02		03				0.45	11.43									0.75	19.05
14	01	14	02	12 / 14	1.26	32.00	0.45	11.43	0.94	23.88	1.22	30.99	1.53	38.89	1.61	40.77	0.75	19.05
	02		03				0.57	14.48									0.89	22.61
16	01	16	02	19 / 16	1.39	35.18	0.51	12.95	0.96	24.38	1.25	31.75	1.66	42.06	1.67	42.34	0.82	20.83
	02		03				0.64	16.26									0.95	24.13
18	01	18	02	27 / 18	1.51	38.35	0.64	16.26	0.98	24.89	1.26	32.00	1.72	43.64	1.73	43.94	0.95	24.13
	02		03				0.76	19.30									1.07	27.18
20	01	20	02	37 / 20	1.64	41.53	0.64	16.26	1.00	25.40	1.29	32.77	1.84	46.84	1.79	45.52	0.95	24.13
	02		03				0.82	20.83									1.13	28.07
22	01	22	02	22	1.76	44.70	0.70	17.78	1.03	26.16	1.31	33.27	1.94	49.23	1.85	46.99	1.02	25.99
	02		03				0.95	24.13									1.26	32.00
24	01	24	02	24	1.89	47.88	0.76	19.30	1.05	26.67	1.34	34.04	2.09	53.16	1.92	48.69	1.07	27.18
	02		03				1.01	25.65									1.32	33.53
28	01	28	02	28	2.14	54.23	0.89	22.61	1.10	27.94	1.38	35.05	2.53	64.29	2.04	51.87	1.19	30.23
	02		03				1.14	28.96									1.47	37.34

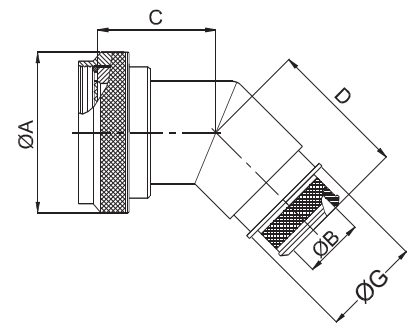
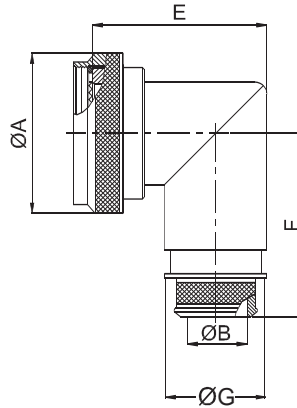

**Amphenol Part Number**

**MIL Part Number**

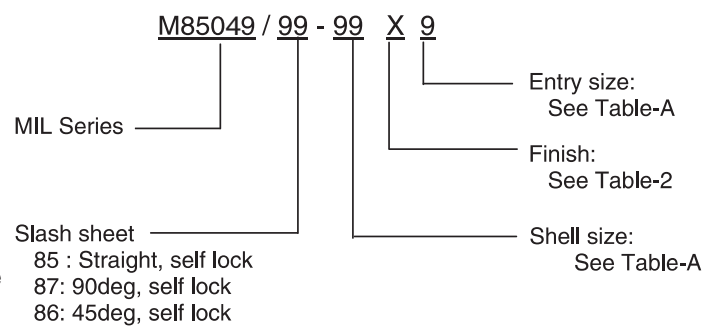
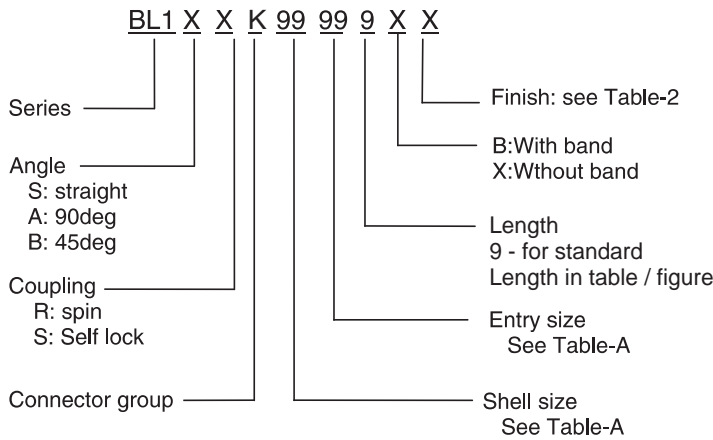

**NOTE:** \* For more cable entry and length options, contact factory

AMPHENOL PART NUMBER DESIGNATOR		MIL PART NUMBER DESIGNATOR		CONNECTOR SHELL SIZE SE - II / I	A DIA. (MAX)		B DIA.		C (MAX)		D (MAX)		E (MAX)		F (MAX)		G (MAX)	
					INCH	MM	+0.00	-0.50	INCH	MM	INCH	MM	INCH	MM	INCH	MM	INCH	MM
08	01	08	01	8 / 9	0.86	21.82	N/A	N/A	0.87	22.10	1.16	29.46	1.38	34.93	1.42	35.99	N/A	N/A
	02		02				0.26	6.60									0.56	14.22
10	01	10	01	10 / 11	0.99	25.04	N/A	N/A	0.90	22.86	1.19	30.23	1.44	36.50	1.48	37.59	N/A	N/A
	02		02				0.32	8.13									0.63	16.00
12	01	12	01	12 / 13	1.16	29.36	0.32	8.13	0.92	23.37	1.21	30.73	1.56	39.67	1.55	39.45	0.63	16.00
	02		02				0.45	11.43									0.75	19.05
14	01	14	01	14 / 15	1.28	32.54	0.45	11.43	0.95	24.13	1.24	31.50	1.69	42.85	1.61	41.00	0.75	19.05
	02		02				0.57	14.48									0.89	22.61
16	01	16	01	16 / 17	1.41	35.71	0.51	12.95	0.98	24.89	1.26	32.00	1.75	44.45	1.68	42.62	0.82	20.83
	02		02				0.64	16.26									0.95	24.13
18	01	18	01	18 / 19	1.52	38.51	0.64	16.26	0.98	24.89	1.27	32.26	1.88	47.63	1.73	44.02	0.95	24.13
	02		02				0.76	19.30									1.07	27.18
20	01	20	01	20 / 21	1.64	41.68	0.64	16.26	1.01	25.65	1.30	33.02	1.94	49.23	1.80	45.62	0.95	24.13
	02		02				0.82	20.83									1.13	28.07
22	01	22	01	22 / 23	1.77	44.86	0.70	17.78	1.04	26.42	1.33	33.78	2.06	52.37	1.86	47.22	1.02	25.99
	02		02				0.95	24.13									1.26	32.00
24	01	24	01	24 / 25	1.89	48.03	0.76	19.30	1.07	27.18	1.35	34.29	2.13	53.98	1.92	48.74	1.07	27.18
	02		02				1.01	25.65									1.32	33.53

### Connector Group - L

Straight, 90°, 45°



Amphenol Part Number

BL1 X X L 99 99 9 X X

Series — BL1  
 Angle — X X  
     S: straight  
     A: 90deg  
     B: 45deg  
 Coupling — L  
     R: spin  
     S: Self lock  
 Connector group — 99 99 9  
 Finish: see Table-2 — X X  
 B: With band  
 X: Without band  
 Length — 9  
 Length in table / figure  
 Entry size — X X  
 See Table-A  
 Shell size —  
 See Table-A

MIL Part Number

M85049 / 99 - 99 X 9

MIL Series — M85049 / 99 - 99  
 Entry size: See Table-A — X  
 Finish: See Table-2 — 9  
 Shell size: See Table-A —

Slash sheet  
 88 : Straight, self lock  
 90: 90deg, self lock  
 89: 45deg, self lock

NOTE: \* For more cable entry and length options, contact factory

AMPHENOL PART NUMBER DESIGNATOR		MIL PART NUMBER DESIGNATOR		CONNECTOR SHELL SIZE/CODE	A DIA. (MAX)		B DIA.		C (MAX)		D (MAX)		E (MAX)		F (MAX.)		G (MAX)	
SHELL SIZE	ENTRY SIZE	CONNECTOR SHELL SIZE	ENTRY SIZE		INCH	MM	+0.00	+0.00	INCH	MM	INCH	MM	INCH	MM	INCH	MM	INCH	MM
							-0.02	-0.50										
08	01	09	02	09 / A	0.86	21.82	N/A	N/A	1.01	25.65	1.16	29.46	1.38	34.93	1.42	35.99	N/A	N/A
	02		03				0.26	6.60									0.56	14.22
10	01	11	02	11 / B	0.99	25.04	N/A	N/A	1.03	26.16	1.19	30.23	1.44	36.50	1.48	37.59	N/A	N/A
	02		03				0.32	8.13									0.63	16.00
12	01	13	02	13 / C	1.16	29.36	0.32	8.13	1.06	26.92	1.21	30.73	1.56	39.67	1.55	39.45	0.63	16.00
	02		03				0.45	11.43									0.75	19.05
14	01	15	02	15 / D	1.28	32.54	0.45	11.43	1.08	27.43	1.24	31.50	1.69	42.85	1.61	41.00	0.75	19.05
	02		03				0.57	14.48									0.89	22.61
16	01	17	02	17 / E	1.41	35.71	0.51	12.95	1.11	28.19	1.26	32.00	1.75	44.45	1.68	42.62	0.82	20.83
	02		03				0.64	16.26									0.95	24.13
18	01	19	02	19 / F	1.52	38.51	0.64	16.26	1.12	28.45	1.27	32.26	1.88	47.63	1.77	45.03	0.95	24.13
	02		03				0.76	19.30									1.07	27.18
20	01	21	02	21 / G	1.64	41.68	0.64	16.26	1.15	29.21	1.30	33.02	1.94	49.23	1.80	45.62	0.95	24.13
	02		03				0.82	20.83									1.13	28.07
22	01	23	02	23 / H	1.77	44.86	0.70	17.78	1.17	29.72	1.33	33.78	2.06	52.37	1.86	47.22	1.02	25.99
	02		03				0.95	24.13									1.26	32.00
24	01	25	02	25 / J	1.89	48.03	0.76	19.30	1.20	30.48	1.35	34.29	2.13	53.98	1.92	48.74	1.07	27.18
	02		03				1.01	25.65									1.32	33.53



**NOTE:** \* For more cable entry and length options, contact factory

AMPHENOL PART NUMBER DESIGNATOR		CONNECTOR SHELL SIZE	A DIA. (MAX)		B DIA.		C (MAX)		D (MAX)		E (MAX)		F (MAX)		G (MAX)	
			INCH	MM	+0.00 -0.02	+0.00 -0.50	INCH	MM	INCH	MM	INCH	MM	INCH	MM	INCH	MM
08	01	8 / 9	0.86	21.82	N/A	N/A	0.87	22.10	1.16	29.46	1.38	34.93	1.42	35.99	N/A	N/A
	02				0.26	6.60									0.56	14.22
10	01	10 / 11	0.99	25.04	N/A	N/A	0.90	22.86	1.19	30.23	1.44	36.50	1.48	37.59	N/A	N/A
	02				0.32	8.13									0.63	16.00
12	01	12 / 13	1.16	29.36	0.32	8.13	0.92	23.37	1.21	30.73	1.56	39.67	1.55	39.45	0.63	16.00
	02				0.45	11.43									0.75	19.05
14	01	14 / 15	1.28	32.54	0.45	11.43	0.95	24.13	1.24	31.50	1.69	42.85	1.61	41.00	0.75	19.05
	02				0.57	14.48									0.89	22.61
16	01	16 / 17	1.41	35.71	0.51	12.95	0.98	24.89	1.26	32.00	1.75	44.45	1.68	42.62	0.82	20.83
	02				0.64	16.26									0.95	24.13
18	01	18 / 19	1.52	38.51	0.64	16.26	0.98	24.89	1.27	32.26	1.88	47.63	1.73	44.02	0.95	24.13
	02				0.76	19.30									1.07	27.18
20	01	20 / 21	1.64	41.68	0.64	16.26	1.01	25.65	1.30	33.02	1.94	49.23	1.80	45.62	0.95	24.13
	02				0.82	20.83									1.13	28.07
22	01	22 / 23	1.77	44.86	0.70	17.78	1.04	26.42	1.33	33.78	2.06	52.37	1.86	47.22	1.02	25.99
	02				0.95	24.13									1.26	32.00
24	01	24 / 25	1.89	48.03	0.76	19.30	1.07	27.18	1.35	34.29	2.13	53.98	1.92	48.74	1.07	27.18
	02				1.01	25.65									1.32	33.53

### Connector Group - N

Straight, 90°, 45°

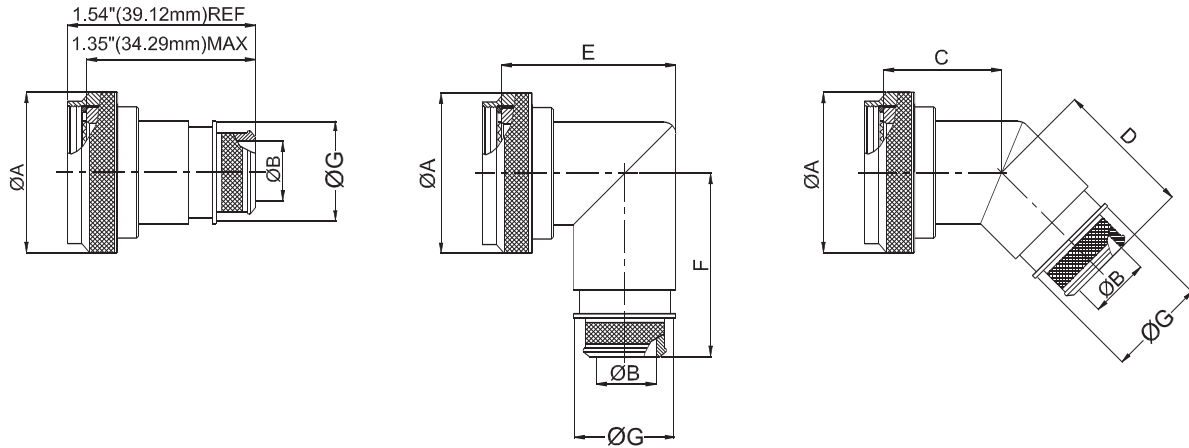

#### Amphenol Part Number



NOTE: \* For more cable entry and length options, contact factory

AMPHENOL PART NUMBER DESIGNATOR		CONNECTOR SHELL SIZE	A DIA. (MAX)		B DIA.		C (MAX)		D (MAX)		E (MAX)		F (MAX)		G (MAX)	
SHELL SIZE	ENTRY SIZE		INCH	MM	+0.00 -0.02	+0.00 -0.50	INCH	MM	INCH	MM	INCH	MM	INCH	MM	INCH	MM
08	01	8 / 9	0.86	21.82	N/A	N/A	0.87	22.10	1.16	29.46	1.38	34.93	1.42	35.99	N/A	N/A
	02				0.26	6.60									0.56	14.22
10	01	10 / 11	0.99	25.04	N/A	N/A	0.90	22.86	1.19	30.23	1.44	36.50	1.48	37.59	N/A	N/A
	02				0.32	8.13									0.63	16.00
12	01	12 / 13	1.16	29.36	0.32	8.13	0.92	23.37	1.21	30.73	1.56	39.67	1.55	39.45	0.63	16.00
	02				0.45	11.43									0.75	19.05
14	01	14 / 15	1.28	32.54	0.45	11.43	0.95	24.13	1.24	31.50	1.69	42.85	1.61	41.00	0.75	19.05
	02				0.57	14.48									0.89	22.61
16	01	16 / 17	1.41	35.71	0.51	12.95	0.98	24.89	1.26	32.00	1.75	44.45	1.68	42.62	0.82	20.83
	02				0.64	16.26									0.95	24.13
18	01	18 / 19	1.52	38.51	0.64	16.26	0.98	24.89	1.27	32.26	1.88	47.63	1.73	44.02	0.95	24.13
	02				0.76	19.30									1.07	27.18
20	01	20 / 21	1.64	41.68	0.64	16.26	1.01	25.65	1.30	33.02	1.94	49.23	1.80	45.62	0.95	24.13
	02				0.82	20.83									1.13	28.07
22	01	22 / 23	1.77	44.86	0.70	17.78	1.04	26.42	1.33	33.78	2.06	52.37	1.86	47.22	1.02	25.99
	02				0.95	24.13									1.26	32.00
24	01	24 / 25	1.89	48.03	0.76	19.30	1.07	27.18	1.35	34.29	2.13	53.98	1.92	48.74	1.07	27.18
	02				1.01	25.65									1.32	33.53

Компания «Океан Электроники» предлагает заключение долгосрочных отношений при поставках импортных электронных компонентов на взаимовыгодных условиях!

Наши преимущества:

- Поставка оригинальных импортных электронных компонентов напрямую с производств Америки, Европы и Азии, а так же с крупнейших складов мира;
- Широкая линейка поставок активных и пассивных импортных электронных компонентов (более 30 млн. наименований);
- Поставка сложных, дефицитных, либо снятых с производства позиций;
- Оперативные сроки поставки под заказ (от 5 рабочих дней);
- Экспресс доставка в любую точку России;
- Помощь Конструкторского Отдела и консультации квалифицированных инженеров;
- Техническая поддержка проекта, помощь в подборе аналогов, поставка прототипов;
- Поставка электронных компонентов под контролем ВП;
- Система менеджмента качества сертифицирована по Международному стандарту ISO 9001;
- При необходимости вся продукция военного и аэрокосмического назначения проходит испытания и сертификацию в лаборатории (по согласованию с заказчиком);
- Поставка специализированных компонентов военного и аэрокосмического уровня качества (Xilinx, Altera, Analog Devices, Intersil, Interpoint, Microsemi, Actel, Aeroflex, Peregrine, VPT, Syfer, Eurofarad, Texas Instruments, MS Kennedy, Miteq, Cobham, E2V, MA-COM, Hittite, Mini-Circuits, General Dynamics и др.);

Компания «Океан Электроники» является официальным дистрибьютором и эксклюзивным представителем в России одного из крупнейших производителей разъемов военного и аэрокосмического назначения «JONHON», а так же официальным дистрибьютором и эксклюзивным представителем в России производителя высокотехнологичных и надежных решений для передачи СВЧ сигналов «FORSTAR».



## JONHON

«JONHON» (основан в 1970 г.)

Разъемы специального, военного и аэрокосмического назначения:

(Применяются в военной, авиационной, аэрокосмической, морской, железнодорожной, горно- и нефтедобывающей отраслях промышленности)

«FORSTAR» (основан в 1998 г.)

ВЧ соединители, коаксиальные кабели, кабельные сборки и микроволновые компоненты:

(Применяются в телекоммуникациях гражданского и специального назначения, в средствах связи, РЛС, а так же военной, авиационной и аэрокосмической отраслях промышленности).



Телефон: 8 (812) 309-75-97 (многоканальный)

Факс: 8 (812) 320-03-32

Электронная почта: [ocean@oceanchips.ru](mailto:ocean@oceanchips.ru)

Web: <http://oceanchips.ru/>

Адрес: 198099, г. Санкт-Петербург, ул. Калинина, д. 2, корп. 4, лит. А