

G3VM-601BY/EY

MOS FET Relays

Analog-switching MOS FET Relays with a Dielectric Strength of 5 kVAC between I/O Using Optical Isolation.



- Switches minute analog signals.
- Switching AC and DC.
- Peak load voltage of 600 V.
- Dielectric strength of 5 kVAC between I/O.

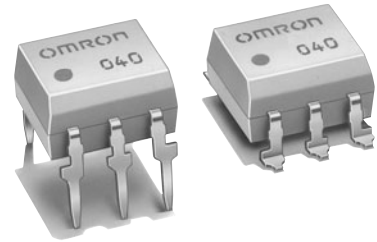

Note: The actual product is marked differently from the image shown here.

RoHS compliant

Application Examples

- Communication equipment
- Test & Measurement equipment
- Industrial equipment
- Security equipment

Terminal Arrangement/Internal Connections

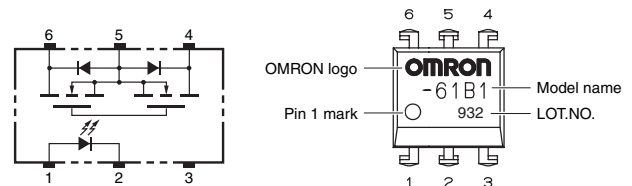

Note: The actual product is marked differently from the image shown here.

List of Models

Package type	Contact form	Terminals	Load voltage (peak value) *	Model	Minimum package quantity	
					Number per tube	Number per tape and reel
DIP6	1a (SPST-NO)	PCB Terminals	600 V	G3VM-601BY	50	-
		Surface-mounting Terminals		G3VM-601EY		
				G3VM-601EY (TR)	-	1,500

* The AC peak and DC value are given for the load voltage.

Absolute Maximum Ratings (Ta = 25°C)

Item	Symbol	Rating	Unit	Measurement conditions	
Input	LED forward current	IF	50	mA	
	Repetitive peak LED forward current	IFP	1	A	
	LED forward current reduction rate	$\Delta I_F / ^\circ C$	-0.5	mA/°C	
	LED reverse voltage	VR	5	V	
Connection temperature	TJ	125	°C		
Output	Load voltage (AC peak/DC)	V _{OFF}	600	V	
	Continuous load current	Connection A	100	mA	Connection A: AC peak/DC Connection B and C: DC
		Connection B	100		
		Connection C	200		
	ON current reduction rate	Connection A	-1.0	mA/°C	Ta ≥ 25°C
		Connection B	-1.0		
		Connection C	-2.0		
Connection temperature	TJ	125	°C		
Dielectric strength between I/O (See note 1.)	V _{I-O}	5000	V _{rms}	AC for 1 min	
Ambient operating temperature	Ta	-40 to +85	°C	With no icing or condensation	
Ambient storage temperature	T _{stg}	-55 to +125	°C	With no icing or condensation	
Soldering temperature	-	260	°C	10 s	

Note: 1. The dielectric strength between the input and output was checked by applying voltage between all pins as a group on the LED side and all pins as a group on the light-receiving side.

Connection Diagram

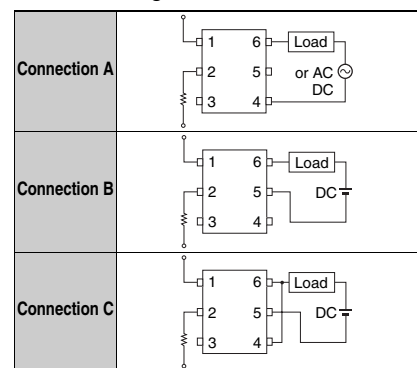

Electrical Characteristics (Ta = 25°C)

Item	Symbol	Minimum	Typical	Maximum	Unit	Measurement conditions	
Input	LED forward voltage	V _F	1.0	1.15	1.3	V	
	Reverse current	I _R	-	-	10	μA	
	Capacity between terminals	C _T	-	30	-	pF	
	Trigger LED forward current	I _{FT}	-	1.6	5	mA	
Output	Maximum resistance with output ON	R _{ON}	Connection A	-	25	35	Ω
			Connection B	-	30	45	Ω
			Connection C	-	23	35	Ω
			Connection C	-	12	18	Ω
	Current leakage when the relay is open	I _{LEAK}	-	-	1.0	μA	
Capacity between terminals	C _{OFF}	-	120	-	pF		
Capacity between I/O terminals	C _{I-O}	-	0.8	-	pF		
Insulation resistance between I/O terminals	R _{I-O}	1000	-	-	MΩ		
Turn-ON time	t _{ON}	-	0.2	1.5	ms		
Turn-OFF time	t _{OFF}	-	0.2	1.0	ms		

Note: 2. Turn-ON and Turn-OFF Times

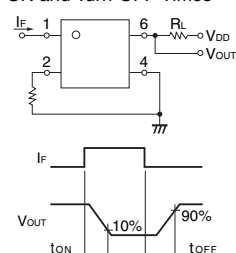

Recommended Operating Conditions

Use the G3VM under the following conditions so that the Relay will operate properly.

Item	Symbol	Minimum	Typical	Maximum	Unit
Load voltage (AC peak/DC)	V _{DD}	-	-	480	V
Operating LED forward current	I _F	7.5	15	25	mA
Continuous load current (AC peak/DC)	I _O	-	-	100	mA
Ambient operating temperature	T _a	-20	-	65	°C

Engineering Data

LED forward current vs. Ambient temperature

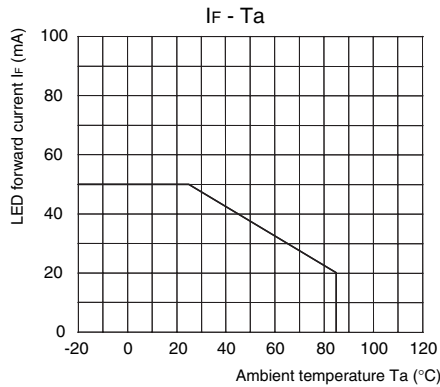

Continuous load current vs. Ambient temperature

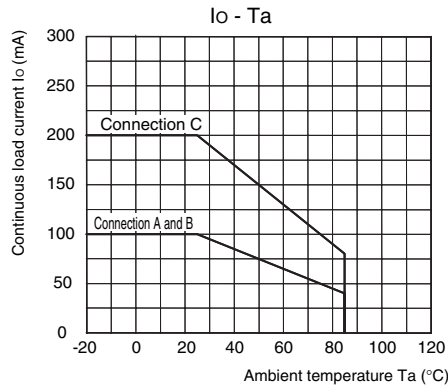

LED forward current vs. LED forward voltage

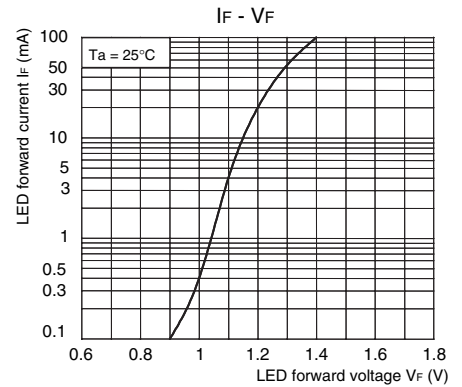

Continuous load current vs. On-state voltage

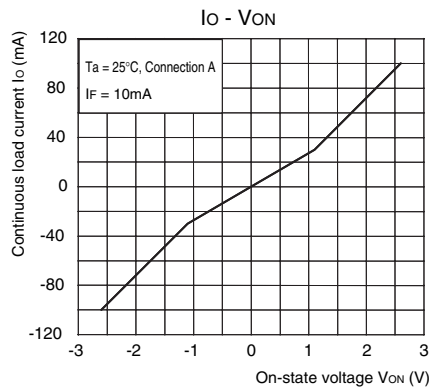

On-state resistance vs. Ambient temperature

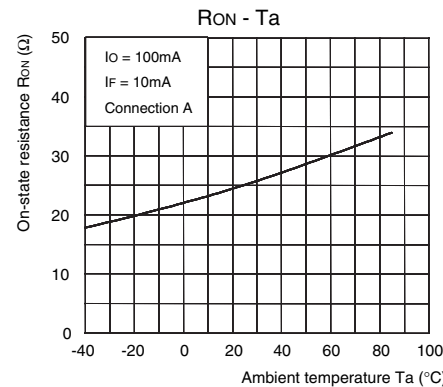

Trigger LED forward current vs. Ambient temperature

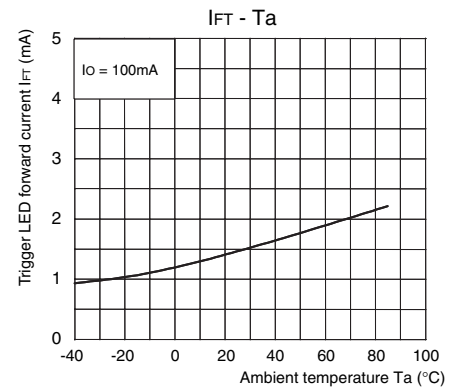

Turn ON, Turn OFF time vs. LED forward current

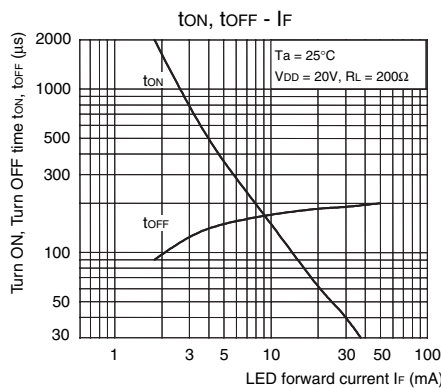

Turn ON, Turn OFF time vs. Ambient temperature

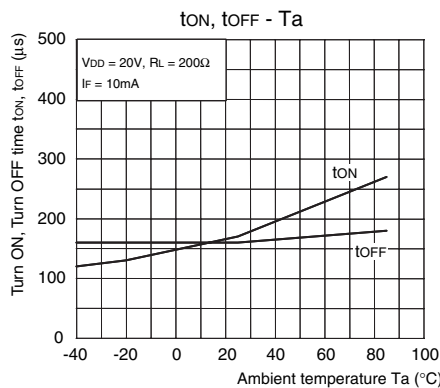

Current leakage vs. Ambient temperature

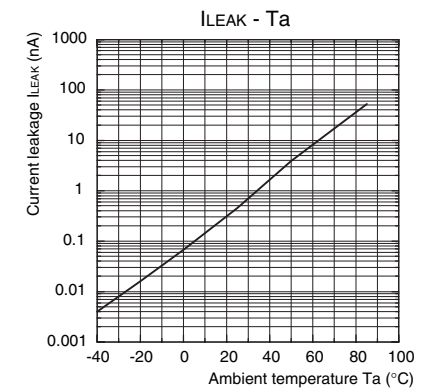

Safety Precautions

- Refer to "Common Precautions" for all G3VM models.

■ Appearance

DIP (Dual Inline Package)

DIP6

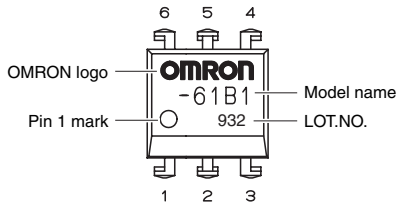

Note: The actual product is marked differently from the image shown here.

■ Dimensions

(Unit:mm)

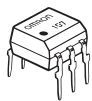

PCB Terminals

Weight: 0.4 g

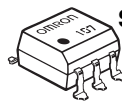
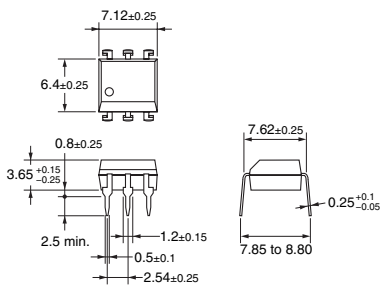

Surface-mounting Terminals

Weight: 0.4 g

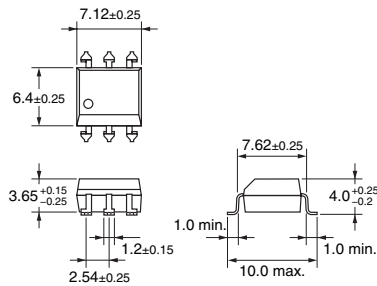

PCB Dimensions (BOTTOM VIEW)

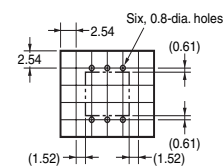

Actual Mounting Pad Dimensions

(Recommended Value, TOP VIEW)

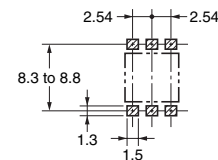

Note: The actual product is marked differently from the image shown here.

- Application examples provided in this document are for reference only. In actual applications, confirm equipment functions and safety before using the product.
- Consult your OMRON representative before using the product under conditions which are not described in the manual or applying the product to nuclear control systems, railroad systems, aviation systems, vehicles, combustion systems, medical equipment, amusement machines, safety equipment, and other systems or equipment that may have a serious influence on lives and property if used improperly. Make sure that the ratings and performance characteristics of the product provide a margin of safety for the system or equipment, and be sure to provide the system or equipment with double safety mechanisms.

Note: Do not use this document to operate the Unit.

OMRON Corporation

ELECTRONIC AND MECHANICAL COMPONENTS COMPANY

Contact: www.omron.com/ecb

Cat. No. **K231-E1-01**
0412(0412)(O)

Компания «Океан Электроники» предлагает заключение долгосрочных отношений при поставках импортных электронных компонентов на взаимовыгодных условиях!

Наши преимущества:

- Поставка оригинальных импортных электронных компонентов напрямую с производств Америки, Европы и Азии, а так же с крупнейших складов мира;
- Широкая линейка поставок активных и пассивных импортных электронных компонентов (более 30 млн. наименований);
- Поставка сложных, дефицитных, либо снятых с производства позиций;
- Оперативные сроки поставки под заказ (от 5 рабочих дней);
- Экспресс доставка в любую точку России;
- Помощь Конструкторского Отдела и консультации квалифицированных инженеров;
- Техническая поддержка проекта, помощь в подборе аналогов, поставка прототипов;
- Поставка электронных компонентов под контролем ВП;
- Система менеджмента качества сертифицирована по Международному стандарту ISO 9001;
- При необходимости вся продукция военного и аэрокосмического назначения проходит испытания и сертификацию в лаборатории (по согласованию с заказчиком);
- Поставка специализированных компонентов военного и аэрокосмического уровня качества (Xilinx, Altera, Analog Devices, Intersil, Interpoint, Microsemi, Actel, Aeroflex, Peregrine, VPT, Syfer, Eurofarad, Texas Instruments, MS Kennedy, Miteq, Cobham, E2V, MA-COM, Hittite, Mini-Circuits, General Dynamics и др.);

Компания «Океан Электроники» является официальным дистрибьютором и эксклюзивным представителем в России одного из крупнейших производителей разъемов военного и аэрокосмического назначения «JONHON», а так же официальным дистрибьютором и эксклюзивным представителем в России производителя высокотехнологичных и надежных решений для передачи СВЧ сигналов «FORSTAR».



JONHON

«JONHON» (основан в 1970 г.)

Разъемы специального, военного и аэрокосмического назначения:

(Применяются в военной, авиационной, аэрокосмической, морской, железнодорожной, горно- и нефтедобывающей отраслях промышленности)

«FORSTAR» (основан в 1998 г.)

ВЧ соединители, коаксиальные кабели, кабельные сборки и микроволновые компоненты:

(Применяются в телекоммуникациях гражданского и специального назначения, в средствах связи, РЛС, а так же военной, авиационной и аэрокосмической отраслях промышленности).



Телефон: 8 (812) 309-75-97 (многоканальный)

Факс: 8 (812) 320-03-32

Электронная почта: ocean@oceanchips.ru

Web: <http://oceanchips.ru/>

Адрес: 198099, г. Санкт-Петербург, ул. Калинина, д. 2, корп. 4, лит. А