

High-performance Regulator IC Series for PCs

Ultra Low Dropout Linear Regulators for PC

BD3550HFN, BD3551HFN, BD3552HFN



(0.5~2.0A)

● Description

BD3550HFN, BD3551HFN, BD3552HFN ultra low-dropout linear chipset regulator operates from a very low input supply, and offers ideal performance in low input voltage to low output voltage applications. It incorporates a built-in N-MOSFET power transistor to minimize the input-to-output voltage differential to the ON resistance ($R_{ON}=100m\Omega$ <BD3552HFN>) level. By lowering the dropout voltage in this way, the regulator realizes high current output ($I_{omax}=2.0A$ <BD3552HFN>) with reduced conversion loss, and thereby obviates the switching regulator and its power transistor, choke coil, and rectifier diode. Thus, BD3550HFN, BD3551HFN, BD3552HFN is designed to enable significant package profile downsizing and cost reduction. An external resistor allows the entire range of output voltage configurations between 0.65 and 2.7V, while the NRCS (soft start) function enables a controlled output voltage ramp-up, which can be programmed to whatever power supply sequence is required.

● Features

- 1) Internal high-precision reference voltage circuit ($0.65V \pm 1\%$)
- 2) Built-in VCC undervoltage lockout circuit
- 3) NRCS (soft start) function reduces the magnitude of in-rush current
- 4) Internal Nch MOSFET driver offers low ON resistance ($100m\Omega$ <BD3552HFN typ>)
- 5) Built-in current limit circuit
- 6) Built-in thermal shutdown (TSD) circuit
- 7) Variable output (0.65~2.7V)
- 8) Small package HSON8 : $2.9 \times 3 \times 0.6(mm)$
- 9) Tracking function

● Applications

Notebook computers, Desktop computers, LCD-TV, DVD, Digital appliances

● Line-up

It is available to select power supply voltage and maximum output voltage.

Maximum Output Voltage	Package	V _{cc} =5V
0.5A	HSON8	BD3550HFN
1.0A		BD3551HFN
2.0A		BD3552HFN

● Absolute maximum ratings

◎ BD3550HFN, BD3551HFN, BD3552HFN

Parameter	Symbol	Limit			Unit
		BD3550HFN	BD3551HFN	BD3552HFN	
Input Voltage 1	VCC	+6.0 * ¹			V
Input Voltage 2	VIN	+6.0 * ¹			V
Enable Input Voltage	Ven	-0.3~+6.0			V
Power Dissipation 1	Pd1	0.63 * ²			W
Power Dissipation 2	Pd2	1.35 * ³			W
Power Dissipation 3	Pd3	1.75 * ⁴			W
Operating Temperature Range	Topr	-10~+100			°C
Storage Temperature Range	Tstg	-55~+150			°C
Maximum Junction Temperature	Tjmax	+150			°C

*1 Should not exceed Pd.

*2 Reduced by 5.04mW/°C for each increase in $T_a \geq 25^\circ\text{C}$ (when mounted on a 70mm × 70mm × 1.6mm glass-epoxy board, 1-layer)
On less than 0.2% (percentage occupied by copper foil).

*3 Reduced by 10.8mW/°C for each increase in $T_a \geq 25^\circ\text{C}$ (when mounted on a 70mm × 70mm × 1.6mm glass-epoxy board, 1-layer)
On less than 7.0% (percentage occupied by copper foil).

*4 Reduced by 14.0mW/°C for each increase in $T_a \geq 25^\circ\text{C}$ (when mounted on a 70mm × 70mm × 1.6mm glass-epoxy board, 1-layer)
On less than 65.0% (percentage occupied by copper foil).

●Operating Voltage(Ta=25°C)

Parameter	Symbol	Min.	Max.	Unit
Input Voltage 1	VCC	4.3	5.5	V
Input Voltage 2	VIN	0.95	VCC-1 *5	V
Output Voltage Setting Range	Vo	VFB	2.7	V
Enable Input Voltage	Ven	0	5.5	V
NRCS Capacity	CNRCS	0.001	1	μF

*5 VCC and VIN do not have to be implemented in the order listed.

★This product is not designed for use in radioactive environments.

●Electrical Characteristics (Unless otherwise specified, Ta=25°C, VCC=5V, Ven=3V, VIN=1.8V, R1=3.9KΩ, R2=3.3KΩ)

Parameter	Symbol	Limit			Unit	Condition	
		Min.	Typ.	Max.			
Bias Current	ICC	-	0.5	1.0	mA		
VCC Shutdown Mode Current	IST	-	0	10	μA	Ven=0V	
Output Voltage	VOOUT	-	1.200	-	V		
Output Voltage Temperature Coefficient	Tcvo	-	0.01	-	%/°C		
Feedback Voltage 1	VFB1	0.643	0.650	0.657	V		
Feedback Voltage 2	VFB2	0.637	0.650	0.663	V	Tj=-10 to 100°C	
Load Regulation	Reg.L	-	0.5	10	mV	Io=0 to 1A (BD3550HFN Io=0A to 0.5A)	
Line Regulation 1	Reg.l1	-	0.1	0.5	%/V	VCC=4.3V to 5.5V	
Line Regulation 2	Reg.l2	-	0.1	0.5	%/V	VIN=1.2V to 3.3V	
Standby Discharge Current	I _{den}	1	-	-	mA	Ven=0V, Vo=1V	
[ENABLE]							
Enable Pin Input Voltage High	Enhi	2	-	-	V		
Enable Pin Input Voltage Low	Enlow	0	-	0.8	V		
Enable Input Bias Current	I _{en}	-	7	10	μA	Ven=3V	
[FEEDBACK]							
Feedback Pin Bias Current	IFB	-100	0	100	nA		
[NRCS]							
NRCS Charge Current	I _{nrcs}	14	20	26	μA	V _{nrcs} =0.5V	
NRCS Standby Voltage	VSTB	-	0	50	mV	Ven=0V	
[UVLO]							
VCC Undervoltage Lockout Threshold Voltage	V _{ccUVLO}	3.5	3.8	4.1	V	V _{cc} :Sweep-up	
VCC Undervoltage Lockout Hysteresis Voltage	V _{ccHys}	100	160	220	mV	V _{cc} :Sweep-down	
[AMP]							
Gate Source Current	I _{GSO}	-	1.6	-	mA	V _{FB} =0, V _{GATE} =2.5V	
Gate Sink Current	I _{GSI}	-	4.7	-	mA	V _{FB} =VCC, V _{GATE} =2.5V	
Maximum output current	BD3550HFN	I _o	0.5	-	-	A	
	BD3551HFN	I _o	1.0	-	-	A	
	BD3552HFN	I _o	2.0	-	-	A	
Minimum dropout voltage	BD3550HFN	dVo	-	200	300	mV	I _o =0.5A, VIN=1.2V, Ta=-10 to 100°C
	BD3551HFN	dvo	-	200	300	mV	I _o =1.0A, VIN=1.2V, Ta=-10 to 100°C
	BD3552HFN	dVo	-	200	300	mV	I _o =2.0A, VIN=1.2V, Ta=-10 to 100°C

●Reference Data(BD3550HFN)

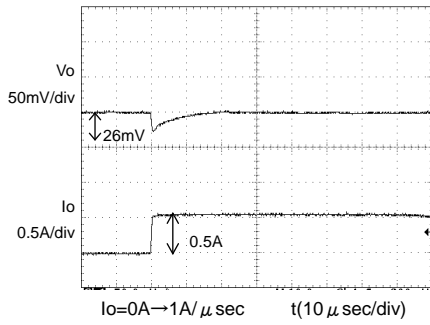

Fig.1 Transient Response
(0→0.5A)
Co=100 μ F, Cfb=1000pF

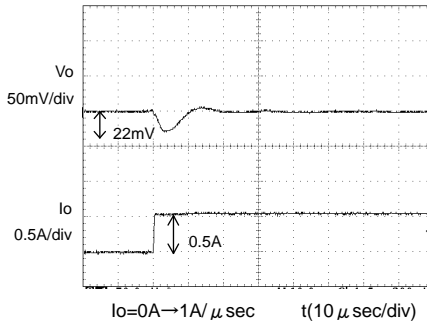

Fig.2 Transient Response
(0→0.5A)
Co=47 μ F, Cfb=1000pF

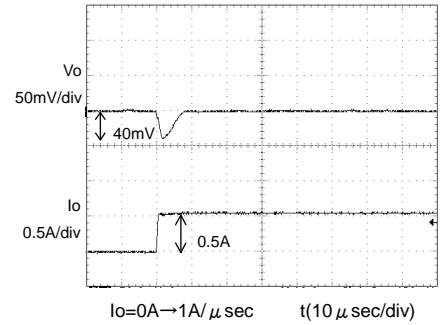

Fig.3 Transient Response
(0→0.5A)
Co=22 μ F, Cfb=1000pF

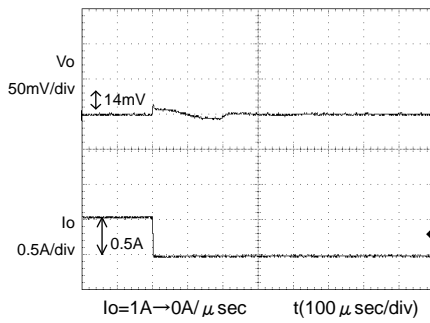

Fig.4 Transient Response
(0.5→0A)
Co=100 μ F, Cfb=1000pF

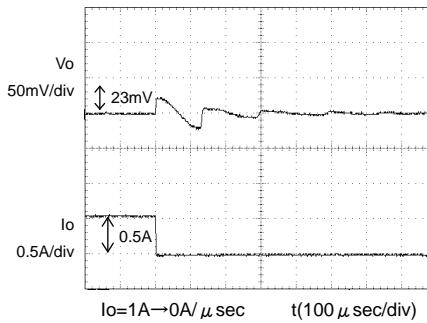

Fig.5 Transient Response
(0.5→0A)
Co=47 μ F, Cfb=1000pF

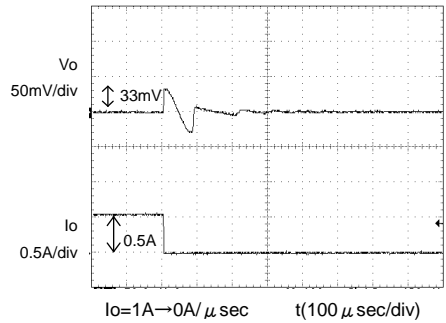

Fig.6 Transient Response
(0.5→0A)
Co=22 μ F, Cfb=1000pF

●Reference Data(BD3551HFN)

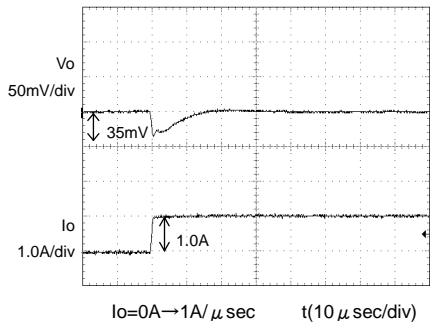

Fig.7 Transient Response
(0→1.0A)
Co=100 μ F, Cfb=1000pF

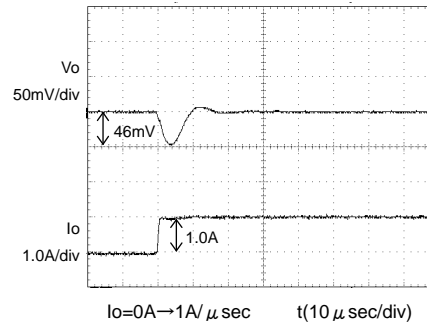

Fig.8 Transient Response
(0→1.0A)
Co=47 μ F, Cfb=1000pF

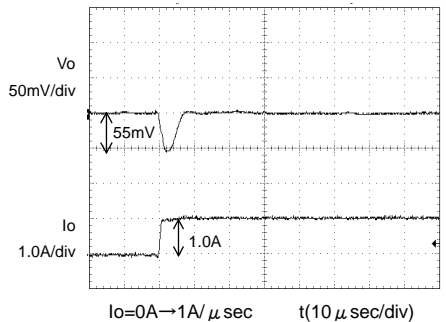

Fig.9 Transient Response
(0→1.0A)
Co=22 μ F, Cfb=1000pF

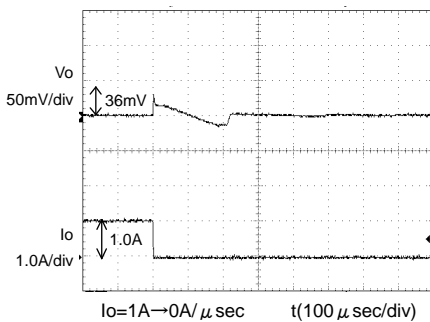

Fig.10 Transient Response
(1.0→0A)
Co=100 μ F, Cfb=1000pF

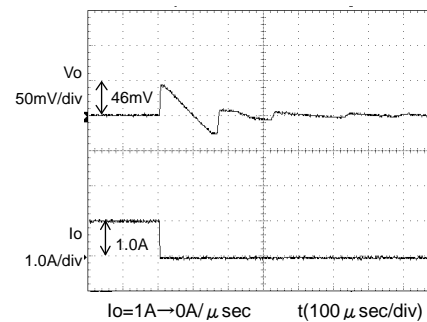

Fig.11 Transient Response
(1.0→0A)
Co=47 μ F, Cfb=1000pF

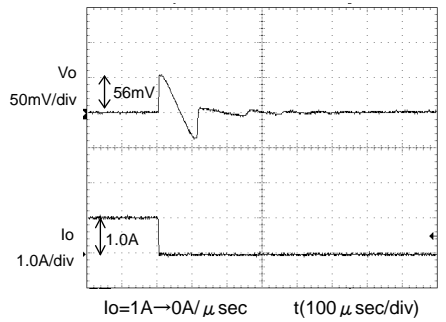
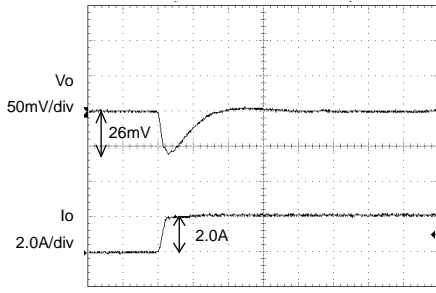
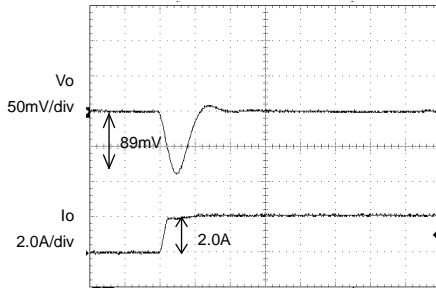

Fig.12 Transient Response
(1.0→0A)
Co=22 μ F, Cfb=1000pF

●Reference Data(BD3552HFN)



Io=0A→1A/μsec t(10 μsec/div)
Fig.13 Transient Response
 (0→2.0A)
 Co=100 μF, Cfb=1000pF



Io=0A→1A/μsec t(10 μsec/div)
Fig.14 Transient Response
 (0→2.0A)
 Co=47 μF, Cfb=1000pF

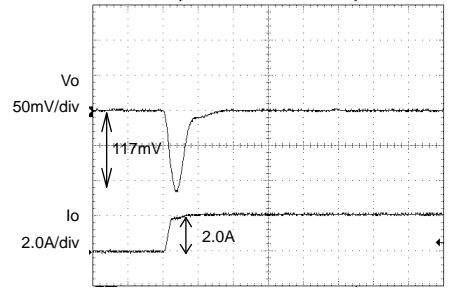

Io=0A→1A/μsec t(10 μsec/div)
Fig.15 Transient Response
 (0→2.0A)
 Co=22 μF, Cfb=1000pF

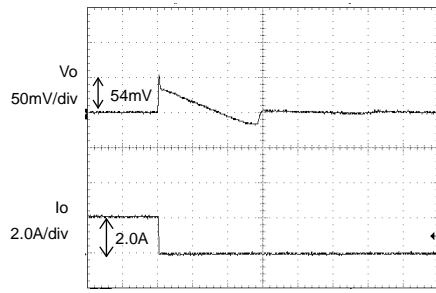

Io=1A→0A/μsec t(100 μsec/div)
Fig.16 Transient Response
 (2.0→0A)
 Co=100 μF, Cfb=1000pF

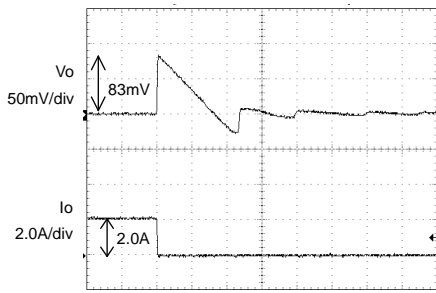

Io=1A→0A/μsec t(100 μsec/div)
Fig.17 Transient Response
 (2.0→0A)
 Co=47 μF, Cfb=1000pF

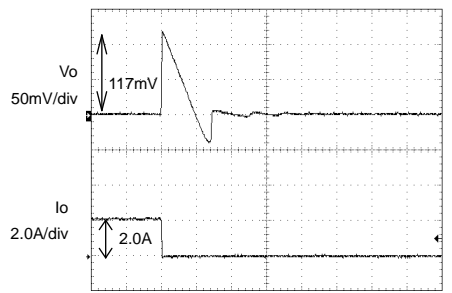

Io=1A→0A/μsec t(100 μsec/div)
Fig.18 Transient Response
 (2.0→0A)
 Co=22 μF, Cfb=1000pF

●Reference Data(BD3551HFN)

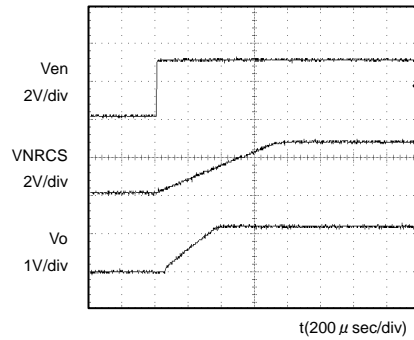

Fig.19 Waveform at output start

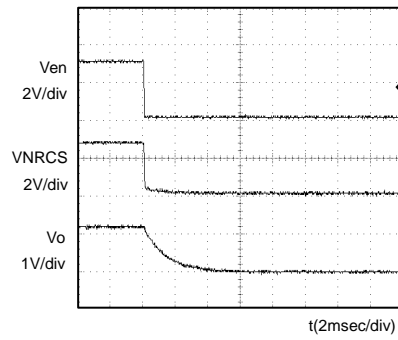

Fig.20 Waveform at output OFF start

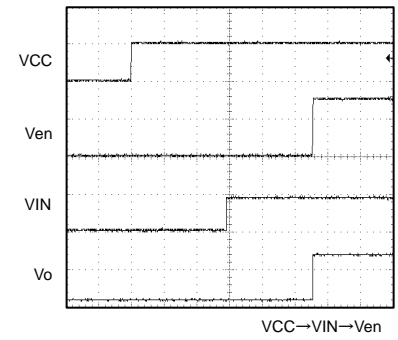

Fig.21 Input sequence

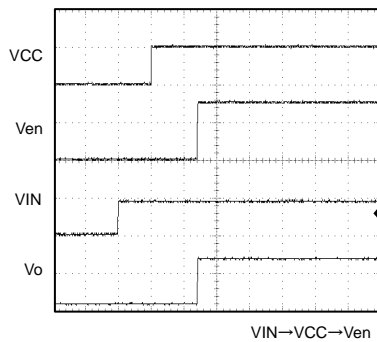

Fig.22 Input sequence

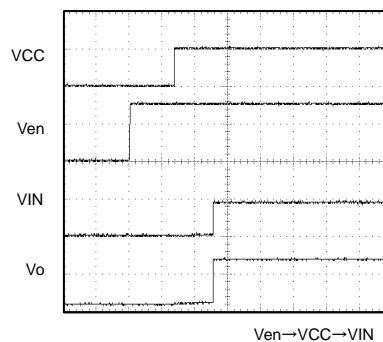

Fig.23 Input sequence

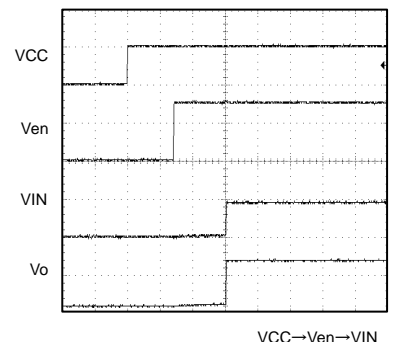

Fig.24 Input sequence

●Reference Data(BD3551HFN)

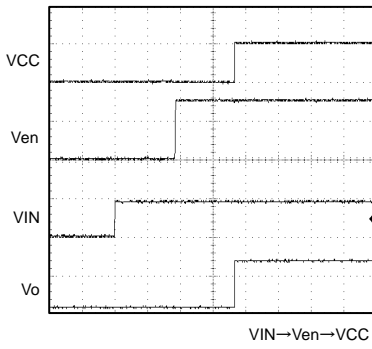

Fig.25 Input sequence

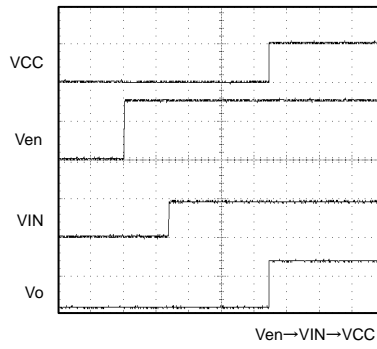

Fig.26 Input sequence

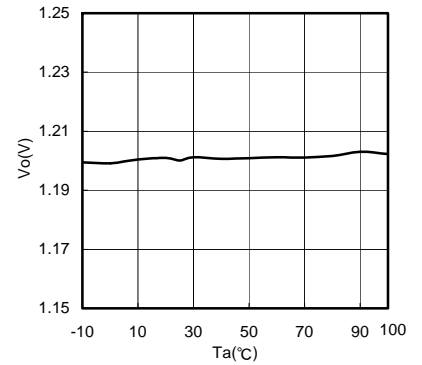

Fig.27 Ta-Vo (Io=0mA)

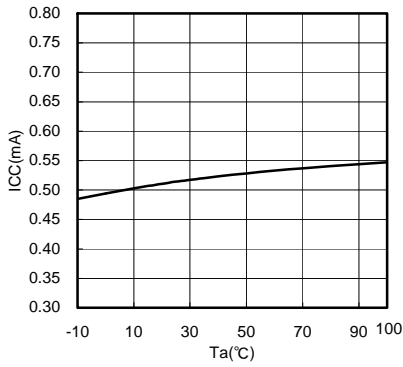

Fig.28 Ta-ICC

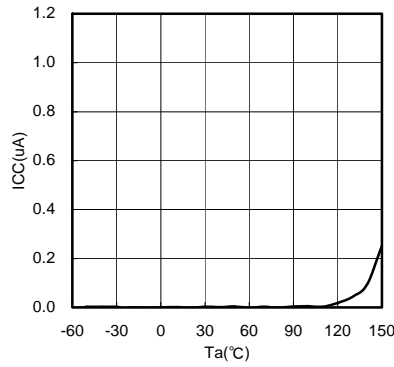

Fig.29 Ta-ISTB

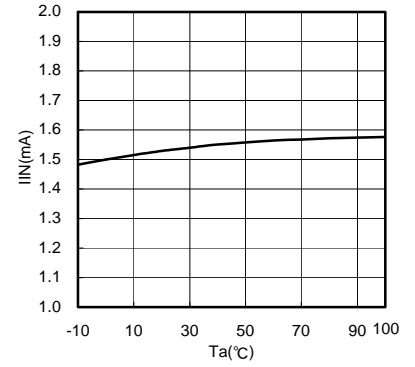

Fig.30 Ta-IIN

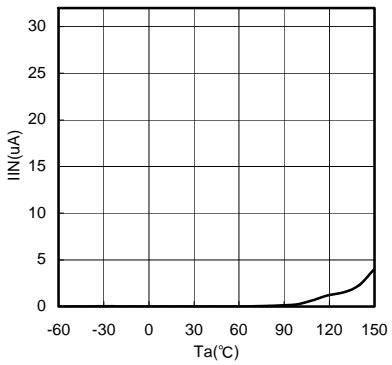

Fig.31 Ta-IINSTB

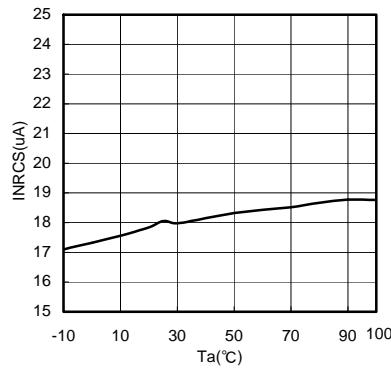

Fig.32 Ta-INRCS

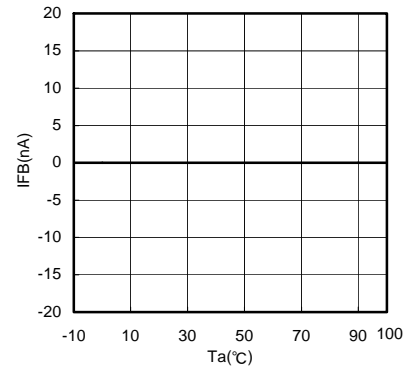

Fig.33 Ta-IFB

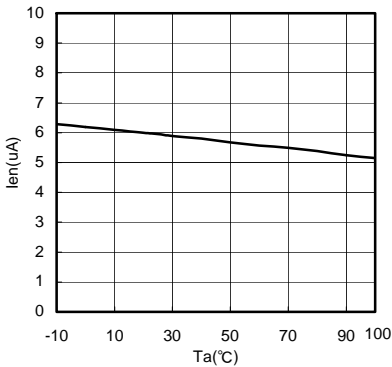

Fig.34 Ta-Ien

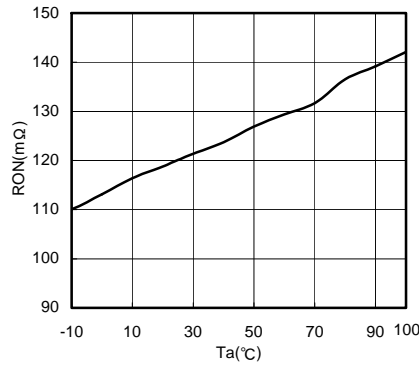

Fig.35 Ta-RON (VCC=5V/Vo=1.2V)

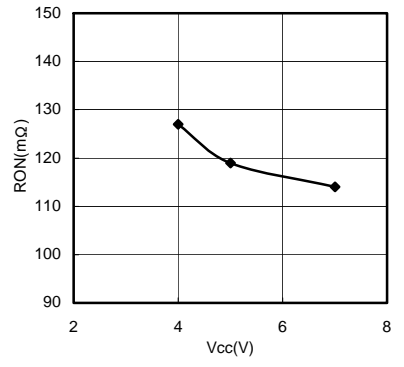
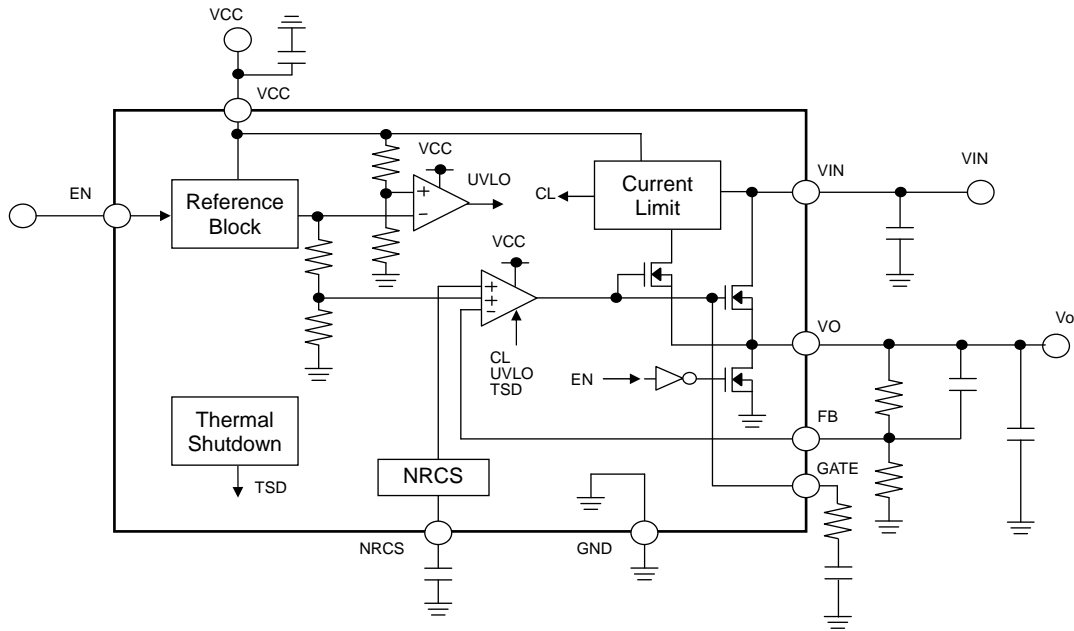

Fig.36 VCC-RON

● Block Diagram



● Pin Layout

PIN No.	PIN name	PIN Function
1	VCC	Power supply pin
2	EN	Enable input pin
3	GATE	Gate pin
4	VIN	Input voltage pin
5	VO	Output voltage pin
6	FB	Reference voltage feedback pin
7	NRCS	In-rush current protection (NRCS) capacitor connection pin
8	GND	Ground pin
reverse	FIN	Connected to heatsink and GND

● Pin Function Table

©HSON8

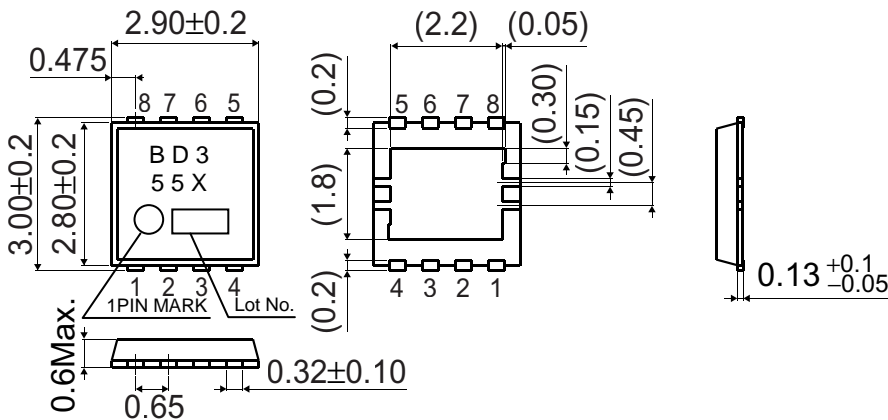

(Unit : mm)

● Operation of Each Block

• AMP

This is an error amp that compares the reference voltage (0.65V) with V_o to drive the output Nch FET ($R_{on}=100m\Omega$:BD3552HFN). Frequency optimization helps to realize rapid transient response, and to support the use of ceramic capacitors on the output. AMP input voltage ranges from GND to 2.7V, while the AMP output ranges from GND to VCC. When EN is OFF, or when UVLO is active, output goes LOW and the output of the NchFET switches OFF.

• EN

The EN block controls the regulator's ON/OFF state via the EN logic input pin. In the OFF position, circuit voltage is maintained at $0\mu A$, thus minimizing current consumption at standby. The FET is switched ON to enable discharge of the NRCS pin V_o , thereby draining the excess charge and preventing the IC on the load side from malfunctioning. Since no electrical connection is required (e.g., between the VCC pin and the ESD prevention Diode), module operation is independent of the input sequence.

• UVLO

To prevent malfunctions that can occur during a momentary decrease in VCC, the UVLO circuit switches the output OFF, and (like the EN block) discharges NRCS and V_o . Once the UVLO threshold voltage (TYP3.80V) is reached, the power-on reset is triggered and output continues.

• CURRENT LIMIT

When output is ON, the current limit function monitors the internal IC output current against the parameter value (2.0A or more:BD3552HFN). When current exceeds this level, the current limit module lowers the output current to protect the load IC. When the overcurrent state is eliminated, output voltage is restored to the parameter value.

• NRCS (Non Rush Current on Start-up)

The soft start function enabled by connecting an external capacitor between the NRCS pin and ground. Output ramp-up can be set for any period up to the time the NRCS pin reaches VFB (0.65V). During startup, the NRCS pin serves as a $20\mu A$ (TYP) constant current source to charge the external capacitor. Output start time is calculated via formula (1) below.

$$t = C \frac{0.65V}{20\mu A} \cdot \cdot \cdot (1)$$

Tracking sequence is available by connecting the output voltage of external power supply instead of external capacitor. And then, ratio-metric sequence is also available by changing the resistor division ratio of external power supply output voltage. (See the next page)

• TSD (Thermal Shut down)

The shutdown (TSD) circuit automatically switches output OFF when the chip temperature gets too high, thus serving to protect the IC against "thermal runaway" and heat damage. Because the TSD circuit is provided to shut down the IC in the presence of extreme heat, in order to avoid potential problems with the TSD, it is crucial that the T_j (max) parameter not be exceeded in the thermal design.

• VIN

The VIN line acts as the major current supply line, and is connected to the output NchFET drain. Since no electrical connection (such as between the VCC pin and the ESD protection Diode) is necessary, VIN operates independent of the input sequence. However, since an output NchFET body Diode exists between VIN and V_o , a VIN- V_o electric (Diode) connection is present. Note, therefore, that when output is switched ON or OFF, reverse current may flow to VIN from V_o .

● Timing Chart
EN ON/OFF

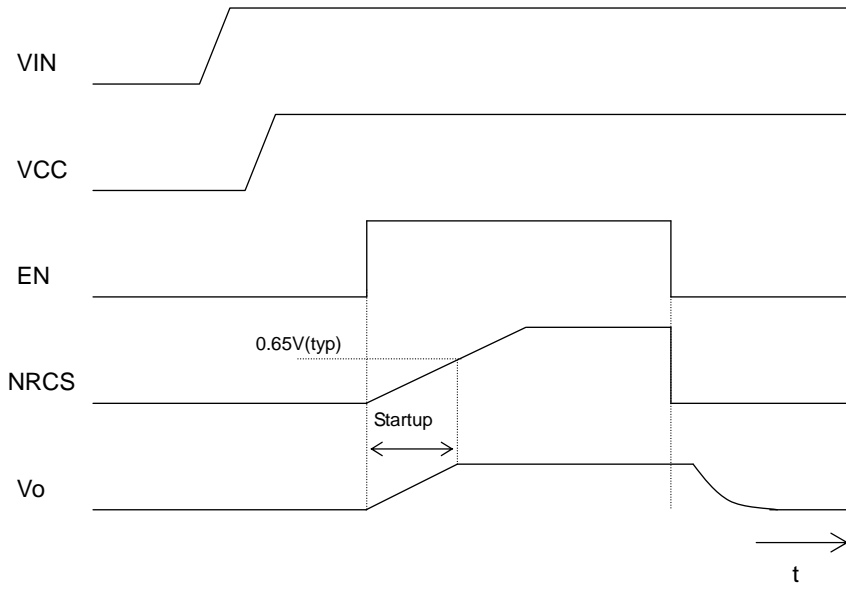

VCC ON/OFF

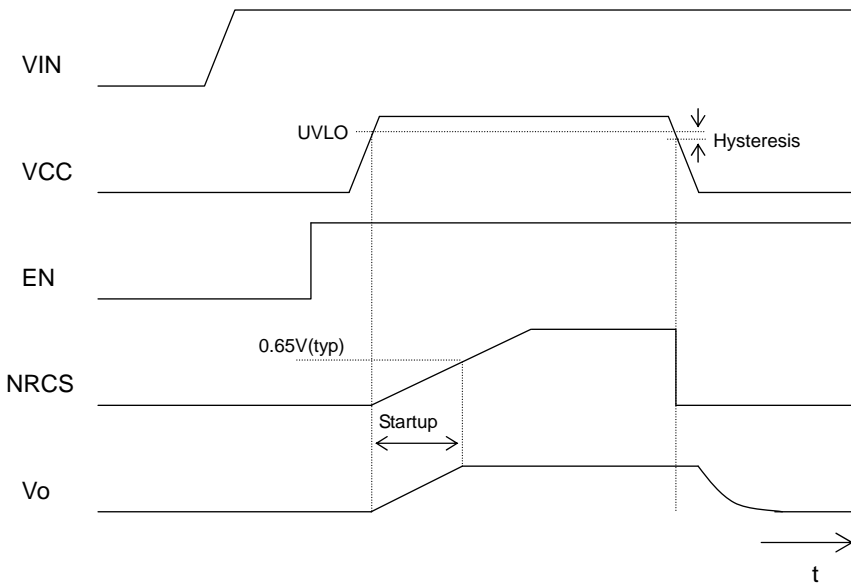

Tracking sequence

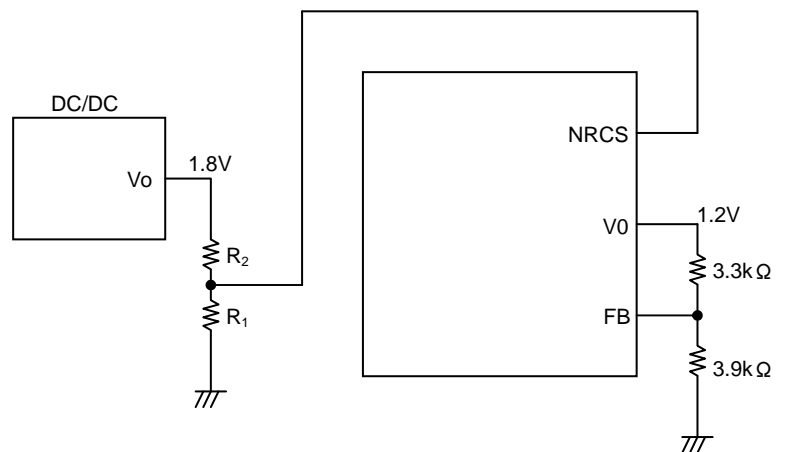
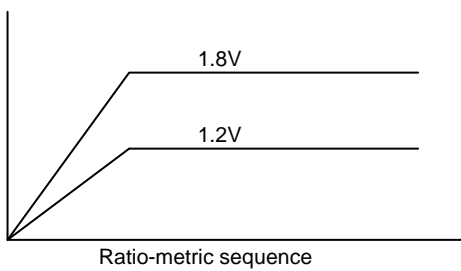
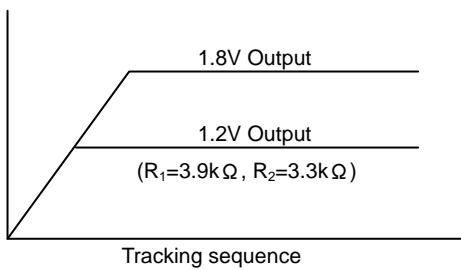

● Evaluation Board

■ BD3550HFN, BD3551HFN, BD3552HFN Evaluation Board Schematic

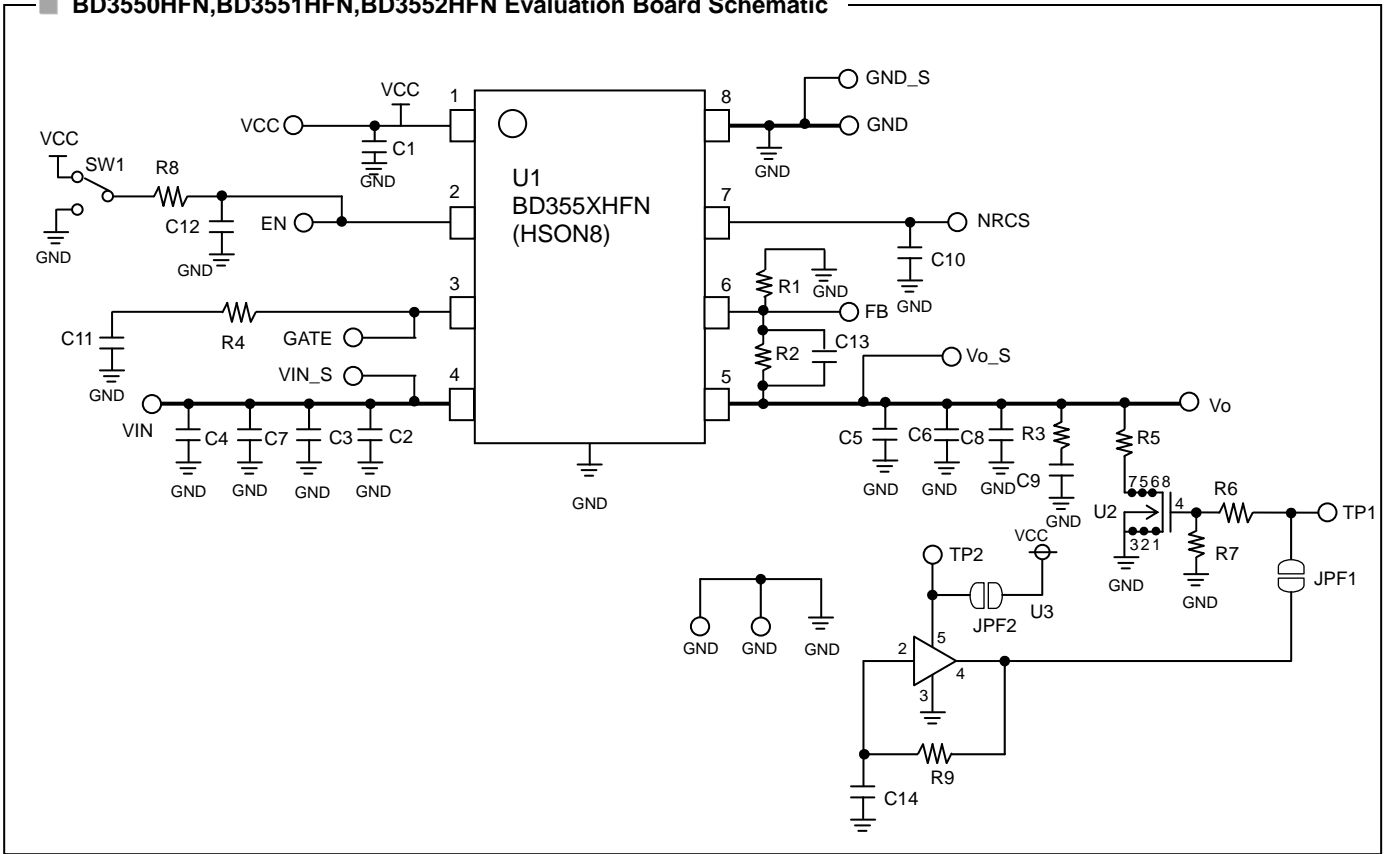

■ BD3550HFN, BD3551HFN, BD3552HFN Evaluation Board Standard Component List

Component	Rating	Manufacturer	Product Name
U1	-	ROHM	BD355XHFN
C1	1uF	MURATA	GRM188B11A105KD
C10	0.01uF	MURATA	GRM188B11H103KD
R8	0Ω	-	Jumper
C5	22uF	KYOCERA	CM32X5R226M10A

Component	Rating	Manufacturer	Product Name
C2	22uF	KYOCERA	CM32X5R226M10A
C13	1000pF	MURATA	GRM188B11H102KD
R1	3.9kΩ	ROHM	MCR03EZPF3301
R2	3.3kΩ	ROHM	MCR03EZPF3901

■ BD3550HFN, BD3551HFN, BD3552HFN Evaluation Board Layout
(2nd layer and 3rd layer is GND Line.)

Silkscreen

TOP Layer

Bottom Layer

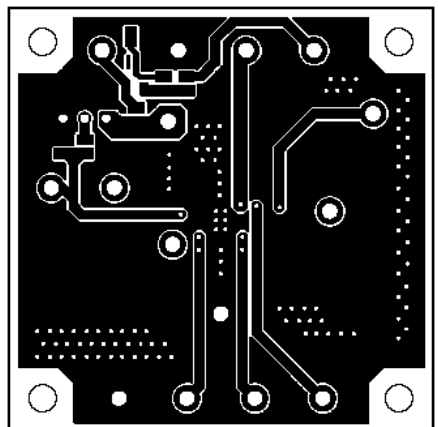
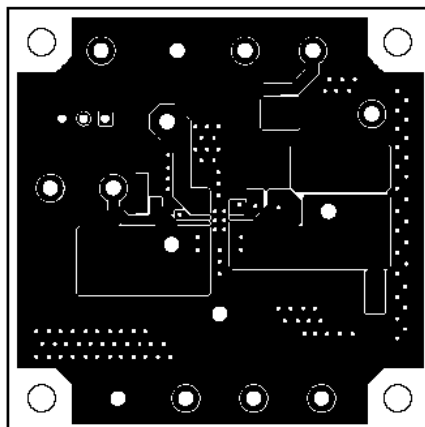
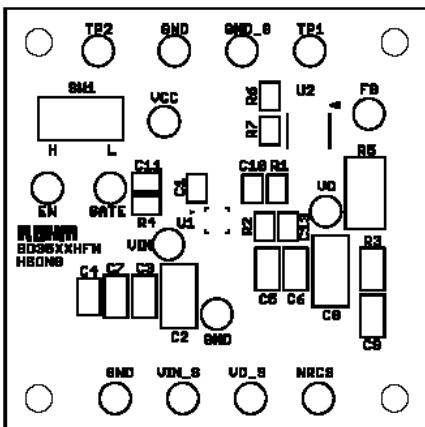

● Recommended Circuit Example

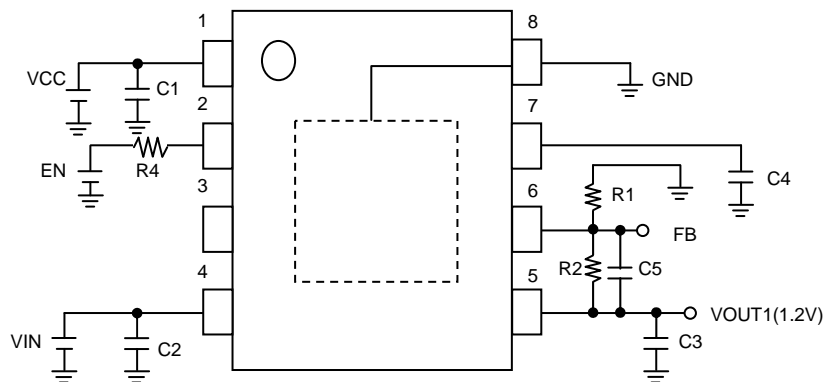

Component	Recommended Value	Programming Notes and Precautions
R1/R2	3.9k/3.3k	IC output voltage can be set with a configuration formula using the values for the internal reference output voltage (V_{FB}) and the output voltage resistors (R1, R2). Select resistance values that will avoid the impact of the VREF current ($\pm 100nA$). The recommended total resistance value is $10K\Omega$.
C3	$22\mu F$	To assure output voltage stability, please be certain the Vo1, Vo2, and Vo3 pins and the GND pins are connected. Output capacitors play a role in loop gain phase compensation and in mitigating output fluctuation during rapid changes in load level. Insufficient capacitance may cause oscillation, while high equivalent series resistance (ESR) will exacerbate output voltage fluctuation under rapid load change conditions. While a $22\mu F$ ceramic capacitor is recommended, actual stability is highly dependent on temperature and load conditions. Also, note that connecting different types of capacitors in series may result in insufficient total phase compensation, thus causing oscillation. In light of this information, please confirm operation across a variety of temperature and load conditions.
C1	$1\mu F$	Input capacitors reduce the output impedance of the voltage supply source connected to the (VCC) input pins. If the impedance of this power supply were to increase, input voltage (VCC) could become unstable, leading to oscillation or lowered ripple rejection function. While a low-ESR $1\mu F$ capacitor with minimal susceptibility to temperature is recommended, stability is highly dependent on the input power supply characteristics and the substrate wiring pattern. In light of this information, please confirm operation across a variety of temperature and load conditions.
C2	$22\mu F$	Input capacitors reduce the output impedance of the voltage supply source connected to the (VIN) input pins. If the impedance of this power supply were to increase, input voltage (VIN) could become unstable, leading to oscillation or lowered ripple rejection function. While a low-ESR $22\mu F$ capacitor with minimal susceptibility to temperature is recommended, stability is highly dependent on the input power supply characteristics and the substrate wiring pattern. In light of this information, please confirm operation across a variety of temperature and load conditions.
C4	$0.01\mu F$	The Non Rush Current on Startup (NRCS) function is built into the IC to prevent rush current from going through the load (VIN to VO) and impacting output capacitors at power supply start-up. Constant current comes from the NRCS pin when EN is HIGH or the UVLO function is deactivated. The temporary reference voltage is proportionate to time, due to the current charge of the NRCS pin capacitor, and output voltage start-up is proportionate to this reference voltage. Capacitors with low susceptibility to temperature are recommended, in order to assure a stable soft-start time.
C5	-	This component is employed when the C3 capacitor causes, or may cause, oscillation. It provides more precise internal phase correction.
R4	Several $k\Omega$ ~several $10k\Omega$	It is recommended that a resistance (several $k\Omega$ to several $10k\Omega$) be put in R4, in case negative voltage is applied in EN pin.

●Heat Loss

Thermal design should allow operation within the following conditions. Note that the temperatures listed are the allowed temperature limits, and thermal design should allow sufficient margin from the limits.

1. Ambient temperature T_a can be no higher than 100°C.
2. Chip junction temperature (T_j) can be no higher than 150°C.

Chip junction temperature can be determined as follows:

- ① Calculation based on ambient temperature (T_a)

$$T_j = T_a + \theta_{j-a} \times W$$

<Reference values>

- θ_{j-a} : HSON8 198.4°C/W 1-layer substrate (copper foil density 0.2%)
- 92.4°C/W 1-layer substrate (copper foil density 7%)
- 71.4°C/W 2-layer substrate (copper foil density 65%)
- Substrate size: 70×70×1.6mm³ (substrate with thermal via)

It is recommended to layout the VIA for heat radiation in the GND pattern of reverse (of IC) when there is the GND pattern in the inner layer (in using multilayer substrate). This package is so small (size: 2.9mm×3.0mm) that it is not available to layout the VIA in the bottom of IC. Spreading the pattern and being increased the number of VIA like the figure below). enable to get the superior heat radiation characteristic. (This figure is the image. It is recommended that the VIA size and the number is designed suitable for the actual situation.).

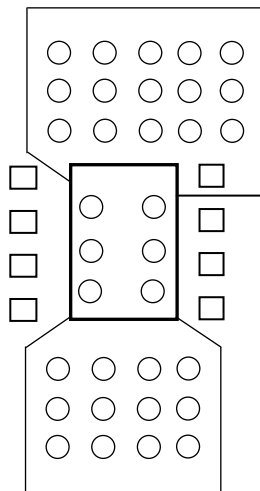

Most of the heat loss that occurs in BD3550HFN, BD3551HFN, BD3552HFN is generated from the output Nch FET. Power loss is determined by the total $V_{IN}-V_o$ voltage and output current. Be sure to confirm the system input and output voltage and the output current conditions in relation to the heat dissipation characteristics of the V_{IN} and V_o in the design. Bearing in mind that heat dissipation may vary substantially depending on the substrate employed (due to the power package incorporated in BD3550HFN, BD3551HFN, BD3552HFN) make certain to factor conditions such as substrate size into the thermal design.

$$\text{Power consumption (W)} = \{ \text{Input voltage (} V_{IN} \text{)} - \text{Output voltage (} V_o \text{)} (V_o \doteq V_{REF}) \} \times I_o(Ave)$$

Example) Where $V_{IN}=1.8V$, $V_o=1.2V$, $I_o(Ave) = 1A$,

$$\begin{aligned} \text{Power consumption (W)} &= \{ 1.8(V) - 1.2(V) \} \times 1.0(A) \\ &= 0.6(W) \end{aligned}$$

● Input-Output Equivalent Circuit Diagram

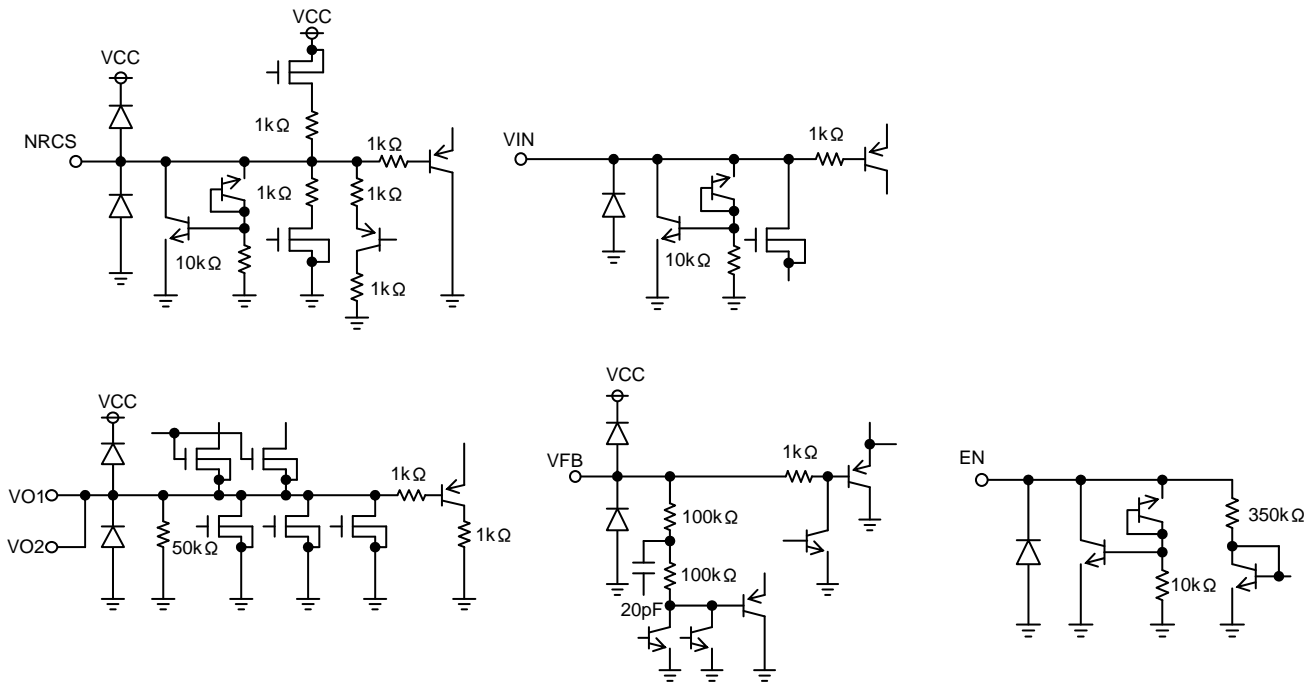

● Reference landing pattern

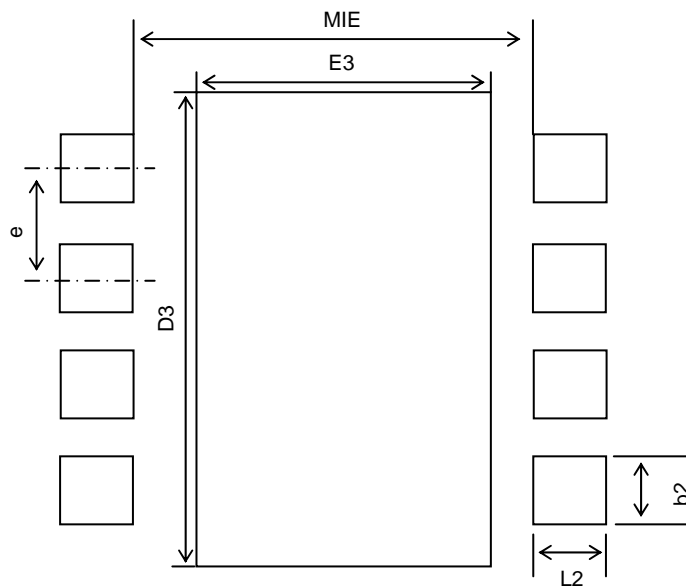

(Unit:mm)

Lead pitch	Lead pitch	landing length	landing pitch
e	MIE	≥ 12	$b2$
0.65	2.50	0.40	0.35
central pad length	central pad pitch		
$D3$	$E3$		
2.90	1.90		

*It is recommended to design suitable for the actual application.

● Operation Notes

1. Absolute maximum ratings

An excess in the absolute maximum ratings, such as supply voltage, temperature range of operating conditions, etc., can break down the devices, thus making impossible to identify breaking mode, such as a short circuit or an open circuit. If any over rated values will expect to exceed the absolute maximum ratings, consider adding circuit protection devices, such as fuses.

2. Connecting the power supply connector backward

Connecting of the power supply in reverse polarity can damage IC. Take precautions when connecting the power supply lines. An external direction diode can be added.

3. Power supply lines

Please add a protection diode when a large inductance component is connected to the output terminal, and reverse-polarity power is possible at startup or in output OFF condition.

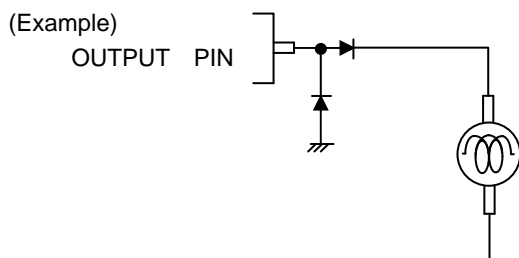

4. GND voltage

The potential of GND pin must be minimum potential in all operating conditions.

5. Thermal design

Use a thermal design that allows for a sufficient margin in light of the power dissipation (Pd) in actual operating conditions.

6. Inter-pin shorts and mounting errors

Use caution when positioning the IC for mounting on printed circuit boards. The IC may be damaged if there is any connection error or if pins are shorted together.

7. Actions in strong electromagnetic field

Use caution when using the IC in the presence of a strong electromagnetic field as doing so may cause the IC to malfunction.

8. ASO

When using the IC, set the output transistor so that it does not exceed absolute maximum ratings or ASO.

9. Thermal shutdown circuit

The IC incorporates a built-in thermal shutdown circuit (TSD circuit). The thermal shutdown circuit (TSD circuit) is designed only to shut the IC off to prevent thermal runaway. It is not designed to protect the IC or guarantee its operation. Do not continue to use the IC after operating this circuit or use the IC in an environment where the operation of this circuit is assumed.

	TSD on temperature [°C] (typ.)	Hysteresis temperature [°C] (typ.)
BD3550HFN, BD3551HFN, BD3552HFN	175	15

10. Testing on application boards

When testing the IC on an application board, connecting a capacitor to a pin with low impedance subjects the IC to stress. Always discharge capacitors after each process or step. Always turn the IC's power supply off before connecting it to or removing it from a jig or fixture during the inspection process. Ground the IC during assembly steps as an antistatic measure. Use similar precaution when transporting or storing the IC.

11. Regarding input pin of the IC

This monolithic IC contains P+ isolation and P substrate layers between adjacent elements in order to keep them isolated. P-N junctions are formed at the intersection of these P layers with the N layers of other elements, creating a parasitic diode or transistor. For example, the relation between each potential is as follows:

When $GND > Pin A$ and $GND > Pin B$, the P-N junction operates as a parasitic diode.

When $GND > Pin B$, the P-N junction operates as a parasitic transistor.

Parasitic diodes can occur inevitable in the structure of the IC. The operation of parasitic diodes can result in mutual interference among circuits, operational faults, or physical damage. Accordingly, methods by which parasitic diodes operate, such as applying a voltage that is lower than the GND (P substrate) voltage to an input pin, should not be used.

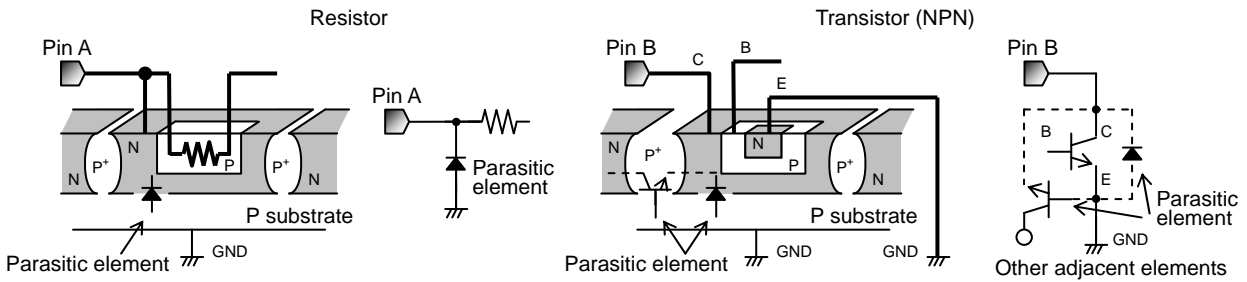

12. Ground Wiring Pattern.

When using both small signal and large current GND patterns, it is recommended to isolate the two ground patterns, placing a single ground point at the ground potential of application so that the pattern wiring resistance and voltage variations caused by large currents do not cause variations in the small signal ground voltage. Be careful not to change the GND wiring pattern of any external components, either.

● Heat Dissipation Characteristics

© HSON8

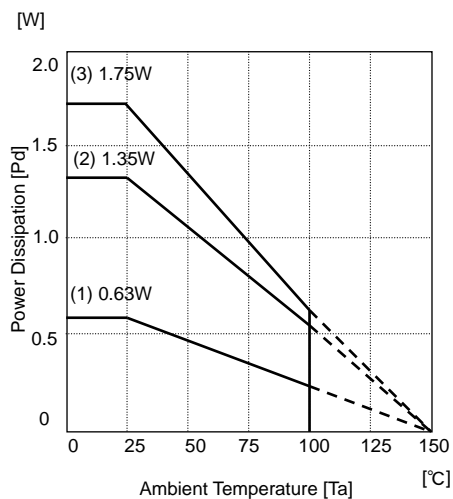

- (1) Substrate (copper foil density: 0.2%...1-layer)
 $\theta_{j-a}=198.4^{\circ}\text{C}/\text{W}$
- (2) Substrate (copper foil density: 7%...1-layer)
 $\theta_{j-a}=92.4^{\circ}\text{C}/\text{W}$
- (3) Substrate (copper foil density: 65%...1-layer)
 $\theta_{j-a}=71.4^{\circ}\text{C}/\text{W}$

●Type Designations (Ordering Information)

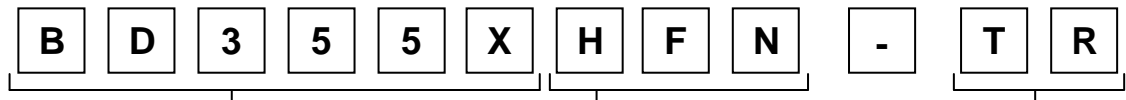

Product Name
• **BD355X**

Package Type
• **HFN : HSON8**

TR Emboss tape reel opposite draw-out side: 1 pin

HSON8

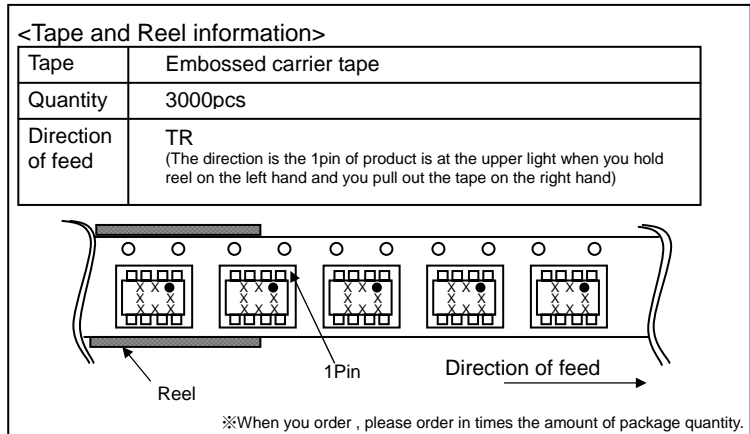
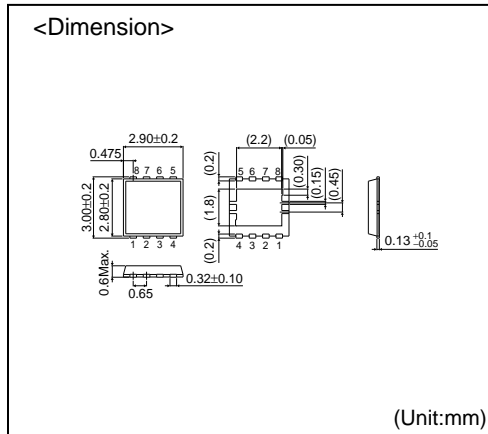

- The contents described herein are correct as of October, 2008
- The contents described herein are subject to change without notice. For updates of the latest information, please contact and confirm with ROHM CO.,LTD.
- Any part of this application note must not be duplicated or copied without our permission.
- Application circuit diagrams and circuit constants contained herein are shown as examples of standard use and operation. Please pay careful attention to the peripheral conditions when designing circuits and deciding upon circuit constants in the set.
- Any data, including, but not limited to application circuit diagrams and information, described herein are intended only as illustrations of such devices and not as the specifications for such devices. ROHM CO.,LTD. disclaims any warranty that any use of such devices shall be free from infringement of any third party's intellectual property rights or other proprietary rights, and further, assumes no liability of whatsoever nature in the event of any such infringement, or arising from or connected with or related to the use of such devices.
- Upon the sale of any such devices, other than for buyer's right to use such devices itself, resell or otherwise dispose of the same, implied right or license to practice or commercially exploit any intellectual property rights or other proprietary rights owned or controlled by ROHM CO., LTD. is granted to any such buyer.
- The products described herein utilize silicon as the main material.
- The products described herein are not designed to be X ray proof.

The products listed in this catalog are designed to be used with ordinary electronic equipment or devices (such as audio visual equipment, office-automation equipment, communications devices, electrical appliances and electronic toys). Should you intend to use these products with equipment or devices which require an extremely high level of reliability and the malfunction of which would directly endanger human life (such as medical instruments, transportation equipment, aerospace machinery, nuclear-reactor controllers, fuel controllers and other safety devices), please be sure to consult with our sales representative in advance.

Contact us for further information about the products.

San Diego	TEL: +1-858-625-3630	FAX: +1-858-625-3670	Tianjin	TEL: +86-22-23029181	FAX: +86-22-23029183
Atlanta	TEL: +1-770-754-5972	FAX: +1-770-754-0691	Shanghai	TEL: +86-21-6279-2727	FAX: +86-21-6247-2066
Boston	TEL: +1-978-371-0382	FAX: +1-928-438-7164	Hangzhou	TEL: +86-571-87658072	FAX: +86-571-87658071
Chicago	TEL: +1-847-368-1006	FAX: +1-847-368-1008	Nanjing	TEL: +86-25-8689-0015	FAX: +86-25-8689-0393
Dallas	TEL: +1-469-287-5366	FAX: +1-469-362-7973	Ningbo	TEL: +86-574-87654201	FAX: +86-574-87654208
Denver	TEL: +1-303-708-0908	FAX: +1-303-708-0858	Qingdao	TEL: +86-532-5779-312	FAX: +86-532-5779-653
Detroit	TEL: +1-248-348-9920	FAX: +1-248-348-9942	Suzhou	TEL: +86-510-82702693	FAX: +86-510-82702992
Nashville	TEL: +1-615-620-6700	FAX: +1-615-620-6702	Wuxi	TEL: +86-510-82706308	FAX: +86-510-82703003
Mexico	TEL: +52-33-3123-2001	FAX: +52-33-3123-2002	Shenzhen	TEL: +86-755-8307-3008	FAX: +86-755-8307-3003
Düsseldorf	TEL: +49-2154-9210	FAX: +49-2154-921400	Dongguan	TEL: +86-769-8393-3320	FAX: +86-769-8398-4140
Munich	TEL: +49-8999-216168	FAX: +49-8999-216176	Fuzhou	TEL: +86-591-8801-8698	FAX: +86-591-8801-8690
Stuttgart	TEL: +49-711-7272-370	FAX: +49-711-7272-3720	Guangzhou	TEL: +86-20-3878-8100	FAX: +86-20-3825-5965
France	TEL: +33-1-5697-3060	FAX: +33-1-5697-3080	Huizhou	TEL: +86-752-205-1054	FAX: +86-752-205-1059
United Kingdom	TEL: +44-1-908-306700	FAX: +44-1-908-235788	Xiamen	TEL: +86-592-238-5705	FAX: +86-592-239-8380
Denmark	TEL: +45-3694-4739	FAX: +45-3694-4789	Zhuhai	TEL: +86-756-3232-480	FAX: +86-756-3232-460
Espoo	TEL: +358-9725-54491	FAX: +358-9-7255-4499	Hong Kong	TEL: +852-2-740-6262	FAX: +852-2-375-8971
Salo	TEL: +358-2-7332234	FAX: +358-2-7332237	Taipei	TEL: +886-2-2500-6956	FAX: +886-2-2503-2869
Oulu	TEL: +358-8-5372930	FAX: +358-8-5372931	Kaohsiung	TEL: +886-7-237-0881	FAX: +886-7-238-7332
Barcelona	TEL: +34-9375-24320	FAX: +34-9375-24410	Singapore	TEL: +65-6332-2322	FAX: +65-6332-5662
Hungary	TEL: +36-1-4719338	FAX: +36-1-4719339	Philippines	TEL: +63-2-807-6872	FAX: +63-2-809-1422
Poland	TEL: +48-22-5757213	FAX: +48-22-5757001	Thailand	TEL: +66-2-254-4890	FAX: +66-2-256-6334
Russia	TEL: +7-495-739-41-74	FAX: +7-495-739-41-74	Kuala Lumpur	TEL: +60-3-7958-8355	FAX: +60-3-7958-8377
Seoul	TEL: +82-2-8182-700	FAX: +82-2-8182-715	Penang	TEL: +60-4-2286453	FAX: +60-4-2286452
Masan	TEL: +82-55-240-6234	FAX: +82-55-240-6236	Kyoto	TEL: +81-75-365-1218	FAX: +81-75-365-1228
Dalian	TEL: +86-411-8230-8549	FAX: +86-411-8230-8537	Yokohama	TEL: +81-45-476-2290	FAX: +81-45-476-2295
Beijing	TEL: +86-10-8525-2483	FAX: +86-10-8525-2489			

Excellence in Electronics



ROHM CO., LTD.

21 Saiin Mizosaki-cho, Ukyo-ku, Kyoto
615-8585, Japan
TEL: +81-75-311-2121 FAX: +81-75-315-0172
URL: <http://www.rohm.com>

Published by
KTC LSI Development Headquarters
LSI Business Promotion Group

Notice

Precaution on using ROHM Products

- Our Products are designed and manufactured for application in ordinary electronic equipments (such as AV equipment, OA equipment, telecommunication equipment, home electronic appliances, amusement equipment, etc.). If you intend to use our Products in devices requiring extremely high reliability (such as medical equipment ^(Note 1), transport equipment, traffic equipment, aircraft/spacecraft, nuclear power controllers, fuel controllers, car equipment including car accessories, safety devices, etc.) and whose malfunction or failure may cause loss of human life, bodily injury or serious damage to property ("Specific Applications"), please consult with the ROHM sales representative in advance. Unless otherwise agreed in writing by ROHM in advance, ROHM shall not be in any way responsible or liable for any damages, expenses or losses incurred by you or third parties arising from the use of any ROHM's Products for Specific Applications.

(Note1) Medical Equipment Classification of the Specific Applications

JAPAN	USA	EU	CHINA
CLASS III	CLASS III	CLASS II b	CLASS III
CLASS IV		CLASS III	

- ROHM designs and manufactures its Products subject to strict quality control system. However, semiconductor products can fail or malfunction at a certain rate. Please be sure to implement, at your own responsibilities, adequate safety measures including but not limited to fail-safe design against the physical injury, damage to any property, which a failure or malfunction of our Products may cause. The following are examples of safety measures:
 - Installation of protection circuits or other protective devices to improve system safety
 - Installation of redundant circuits to reduce the impact of single or multiple circuit failure
- Our Products are designed and manufactured for use under standard conditions and not under any special or extraordinary environments or conditions, as exemplified below. Accordingly, ROHM shall not be in any way responsible or liable for any damages, expenses or losses arising from the use of any ROHM's Products under any special or extraordinary environments or conditions. If you intend to use our Products under any special or extraordinary environments or conditions (as exemplified below), your independent verification and confirmation of product performance, reliability, etc. prior to use, must be necessary:
 - Use of our Products in any types of liquid, including water, oils, chemicals, and organic solvents
 - Use of our Products outdoors or in places where the Products are exposed to direct sunlight or dust
 - Use of our Products in places where the Products are exposed to sea wind or corrosive gases, including Cl₂, H₂S, NH₃, SO₂, and NO₂
 - Use of our Products in places where the Products are exposed to static electricity or electromagnetic waves
 - Use of our Products in proximity to heat-producing components, plastic cords, or other flammable items
 - Sealing or coating our Products with resin or other coating materials
 - Use of our Products without cleaning residue of flux (even if you use no-clean type fluxes, cleaning residue of flux is recommended); or Washing our Products by using water or water-soluble cleaning agents for cleaning residue after soldering
 - Use of the Products in places subject to dew condensation
- The Products are not subject to radiation-proof design.
- Please verify and confirm characteristics of the final or mounted products in using the Products.
- In particular, if a transient load (a large amount of load applied in a short period of time, such as pulse. is applied, confirmation of performance characteristics after on-board mounting is strongly recommended. Avoid applying power exceeding normal rated power; exceeding the power rating under steady-state loading condition may negatively affect product performance and reliability.
- De-rate Power Dissipation (Pd) depending on Ambient temperature (Ta). When used in sealed area, confirm the actual ambient temperature.
- Confirm that operation temperature is within the specified range described in the product specification.
- ROHM shall not be in any way responsible or liable for failure induced under deviant condition from what is defined in this document.

Precaution for Mounting / Circuit board design

- When a highly active halogenous (chlorine, bromine, etc.) flux is used, the residue of flux may negatively affect product performance and reliability.
- In principle, the reflow soldering method must be used; if flow soldering method is preferred, please consult with the ROHM representative in advance.

For details, please refer to ROHM Mounting specification

Precautions Regarding Application Examples and External Circuits

1. If change is made to the constant of an external circuit, please allow a sufficient margin considering variations of the characteristics of the Products and external components, including transient characteristics, as well as static characteristics.
2. You agree that application notes, reference designs, and associated data and information contained in this document are presented only as guidance for Products use. Therefore, in case you use such information, you are solely responsible for it and you must exercise your own independent verification and judgment in the use of such information contained in this document. ROHM shall not be in any way responsible or liable for any damages, expenses or losses incurred by you or third parties arising from the use of such information.

Precaution for Electrostatic

This Product is electrostatic sensitive product, which may be damaged due to electrostatic discharge. Please take proper caution in your manufacturing process and storage so that voltage exceeding the Products maximum rating will not be applied to Products. Please take special care under dry condition (e.g. Grounding of human body / equipment / solder iron, isolation from charged objects, setting of ionizer, friction prevention and temperature / humidity control).

Precaution for Storage / Transportation

1. Product performance and soldered connections may deteriorate if the Products are stored in the places where:
 - [a] the Products are exposed to sea winds or corrosive gases, including Cl₂, H₂S, NH₃, SO₂, and NO₂
 - [b] the temperature or humidity exceeds those recommended by ROHM
 - [c] the Products are exposed to direct sunshine or condensation
 - [d] the Products are exposed to high Electrostatic
2. Even under ROHM recommended storage condition, solderability of products out of recommended storage time period may be degraded. It is strongly recommended to confirm solderability before using Products of which storage time is exceeding the recommended storage time period.
3. Store / transport cartons in the correct direction, which is indicated on a carton with a symbol. Otherwise bent leads may occur due to excessive stress applied when dropping of a carton.
4. Use Products within the specified time after opening a humidity barrier bag. Baking is required before using Products of which storage time is exceeding the recommended storage time period.

Precaution for Product Label

QR code printed on ROHM Products label is for ROHM's internal use only.

Precaution for Disposition

When disposing Products please dispose them properly using an authorized industry waste company.

Precaution for Foreign Exchange and Foreign Trade act

Since our Products might fall under controlled goods prescribed by the applicable foreign exchange and foreign trade act, please consult with ROHM representative in case of export.

Precaution Regarding Intellectual Property Rights

1. All information and data including but not limited to application example contained in this document is for reference only. ROHM does not warrant that foregoing information or data will not infringe any intellectual property rights or any other rights of any third party regarding such information or data. ROHM shall not be in any way responsible or liable for infringement of any intellectual property rights or other damages arising from use of such information or data.:
2. No license, expressly or implied, is granted hereby under any intellectual property rights or other rights of ROHM or any third parties with respect to the information contained in this document.

Other Precaution

1. This document may not be reprinted or reproduced, in whole or in part, without prior written consent of ROHM.
2. The Products may not be disassembled, converted, modified, reproduced or otherwise changed without prior written consent of ROHM.
3. In no event shall you use in any way whatsoever the Products and the related technical information contained in the Products or this document for any military purposes, including but not limited to, the development of mass-destruction weapons.
4. The proper names of companies or products described in this document are trademarks or registered trademarks of ROHM, its affiliated companies or third parties.

General Precaution

1. Before you use our Products, you are requested to carefully read this document and fully understand its contents. ROHM shall not be in any way responsible or liable for failure, malfunction or accident arising from the use of any ROHM's Products against warning, caution or note contained in this document.
2. All information contained in this document is current as of the issuing date and subject to change without any prior notice. Before purchasing or using ROHM's Products, please confirm the latest information with a ROHM sales representative.
3. The information contained in this document is provided on an "as is" basis and ROHM does not warrant that all information contained in this document is accurate and/or error-free. ROHM shall not be in any way responsible or liable for any damages, expenses or losses incurred by you or third parties resulting from inaccuracy or errors of or concerning such information.

Компания «Океан Электроники» предлагает заключение долгосрочных отношений при поставках импортных электронных компонентов на взаимовыгодных условиях!

Наши преимущества:

- Поставка оригинальных импортных электронных компонентов напрямую с производств Америки, Европы и Азии, а так же с крупнейших складов мира;
- Широкая линейка поставок активных и пассивных импортных электронных компонентов (более 30 млн. наименований);
- Поставка сложных, дефицитных, либо снятых с производства позиций;
- Оперативные сроки поставки под заказ (от 5 рабочих дней);
- Экспресс доставка в любую точку России;
- Помощь Конструкторского Отдела и консультации квалифицированных инженеров;
- Техническая поддержка проекта, помощь в подборе аналогов, поставка прототипов;
- Поставка электронных компонентов под контролем ВП;
- Система менеджмента качества сертифицирована по Международному стандарту ISO 9001;
- При необходимости вся продукция военного и аэрокосмического назначения проходит испытания и сертификацию в лаборатории (по согласованию с заказчиком);
- Поставка специализированных компонентов военного и аэрокосмического уровня качества (Xilinx, Altera, Analog Devices, Intersil, Interpoint, Microsemi, Actel, Aeroflex, Peregrine, VPT, Syfer, Eurofarad, Texas Instruments, MS Kennedy, Miteq, Cobham, E2V, MA-COM, Hittite, Mini-Circuits, General Dynamics и др.);

Компания «Океан Электроники» является официальным дистрибьютором и эксклюзивным представителем в России одного из крупнейших производителей разъемов военного и аэрокосмического назначения «JONHON», а так же официальным дистрибьютором и эксклюзивным представителем в России производителя высокотехнологичных и надежных решений для передачи СВЧ сигналов «FORSTAR».



JONHON

«JONHON» (основан в 1970 г.)

Разъемы специального, военного и аэрокосмического назначения:

(Применяются в военной, авиационной, аэрокосмической, морской, железнодорожной, горно- и нефтедобывающей отраслях промышленности)

«FORSTAR» (основан в 1998 г.)

ВЧ соединители, коаксиальные кабели, кабельные сборки и микроволновые компоненты:

(Применяются в телекоммуникациях гражданского и специального назначения, в средствах связи, РЛС, а так же военной, авиационной и аэрокосмической отраслях промышленности).



Телефон: 8 (812) 309-75-97 (многоканальный)

Факс: 8 (812) 320-03-32

Электронная почта: ocean@oceanchips.ru

Web: <http://oceanchips.ru/>

Адрес: 198099, г. Санкт-Петербург, ул. Калинина, д. 2, корп. 4, лит. А