

EVA-M

~25° medium beam

TECHNICAL SPECIFICATIONS:

Dimensions	Ø 35.0 mm
Height	16.4 mm
Fastening	glue
ROHS compliant	yes 

MATERIAL SPECIFICATIONS:

Component	Type	Material	Colour	Finish
EVA-M	Single lens	PMMA	clear	



ORDERING INFORMATION:

Component	Qty in box	MOQ	MPQ	Box weight (kg)
C10685_EVA-M » Box size: 480 x 280 x 300 mm	540	90	45	5.8

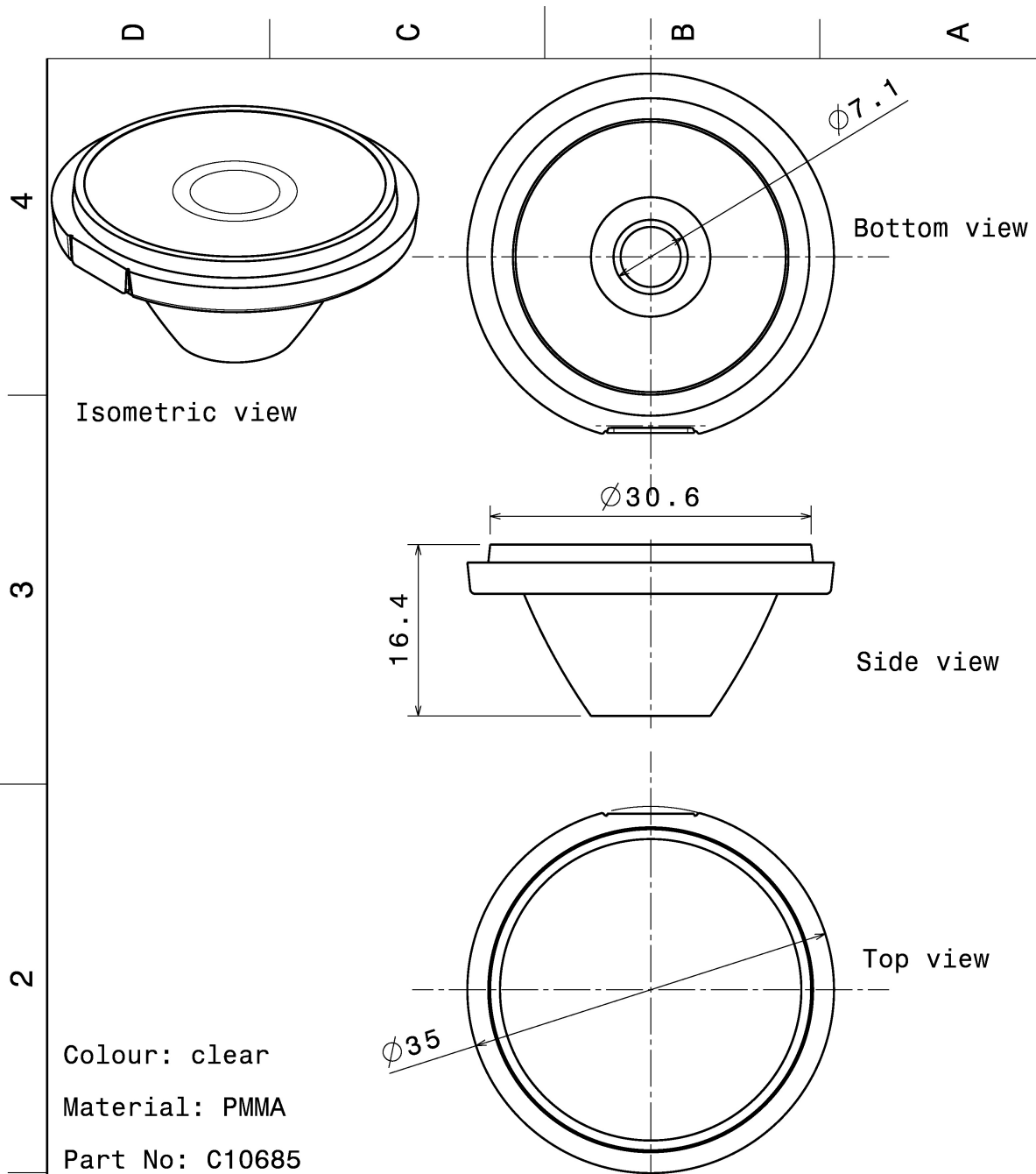

This drawing is our property. It can't be reproduced or communicated without our written agreement.



Ledil Oy
Joensuunkatu 13
FIN-24100 SALO
Finland

DRAWING TITLE

Datasheet Eva Medium Lens

DRAWN BY	DATE
PV	05.09.2008

CHECKED BY	DATE
hh	04.09.2008

DESIGNED BY	DATE
HH	26.08.2008

SIZE	DRAWING NUMBER	REV
A4	C10685	1.0

SCALE	2:1	WEIGHT (g)	SHEET	1/1
-------	-----	------------	-------	-----

PHOTOMETRIC DATA (MEASURED):

CITIZEN

LED CLU7A2 (LES 4.2mm)
FWHM 22.0°
Efficiency 89 %
Peak intensity 4.2 cd/lm
LEDs/each optic 1
Light colour White
Required components:

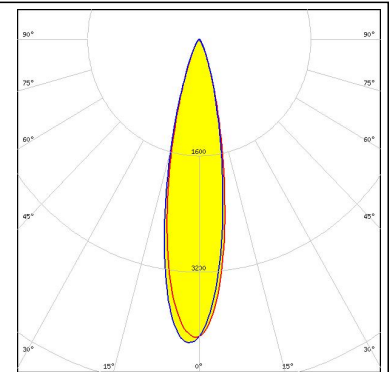

CREE

LED MC-E
FWHM 22.0°
Efficiency 89 %
Peak intensity 3 cd/lm
LEDs/each optic 1
Light colour White
Required components:

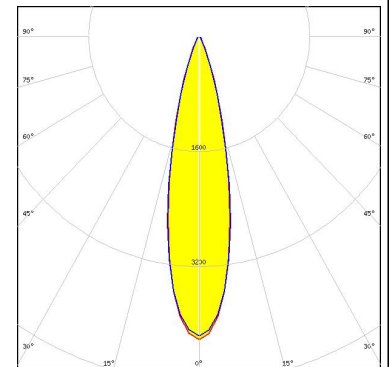
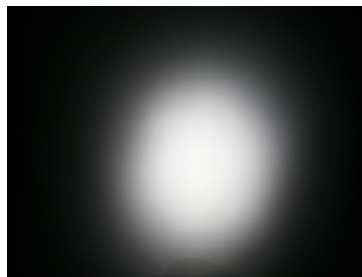

CREE

LED MHB-A/B
FWHM 25.0°
Efficiency 82 %
Peak intensity 3.6 cd/lm
LEDs/each optic 1
Light colour White
Required components:

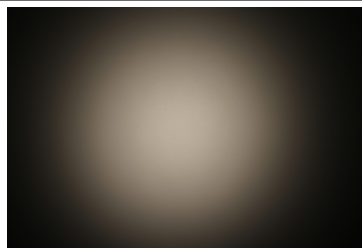

CREE

LED XHP35 HI
FWHM 28.0°
Efficiency 78 %
Peak intensity 2.3 cd/lm
LEDs/each optic 1
Light colour White
Required components:

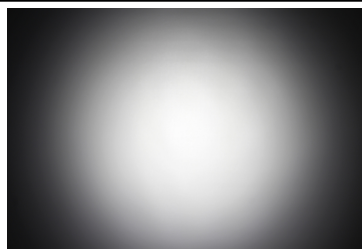

PHOTOMETRIC DATA (MEASURED):



LED XM-L
FWHM 24.0°
Efficiency 88 %
LEDs/each optic 1
Light colour White
Required components:



LED XP-G2
FWHM 24.0°
Efficiency 88 %
Peak intensity 4.2 cd/lm
LEDs/each optic 1
Light colour White
Required components:



LED XT-E
FWHM 24.0°
Efficiency %
Peak intensity 3.7 cd/lm
LEDs/each optic 1
Light colour White
Required components:

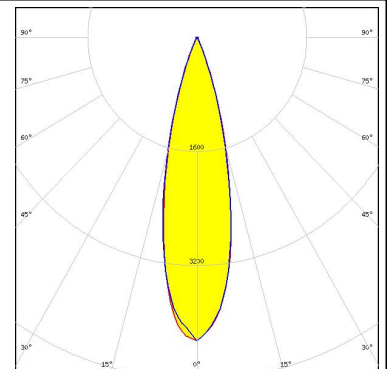

LED LUXEON 5050 Round LES
FWHM 25.0°
Efficiency 85 %
Peak intensity 3.3 cd/lm
LEDs/each optic 1
Light colour White
Required components:

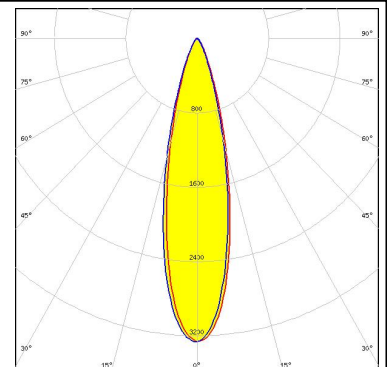

PHOTOMETRIC DATA (MEASURED):

LUMILEDS

LED LUXEON M/MX
 FWHM 26.0°
 Efficiency 89 %
 Peak intensity 2.8 cd/lm
 LEDs/each optic 1
 Light colour White
 Required components:

LUMILEDS

LED LUXEON MZ
 FWHM 24.0°
 Efficiency 87 %
 Peak intensity 4.2 cd/lm
 LEDs/each optic 1
 Light colour White
 Required components:

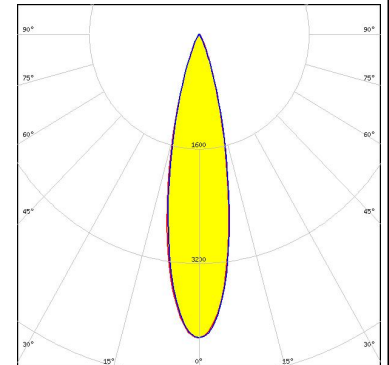

NICHIA

LED NS9x383
 FWHM 24.0°
 Efficiency 88 %
 Peak intensity 3.7 cd/lm
 LEDs/each optic 1
 Light colour White
 Required components:

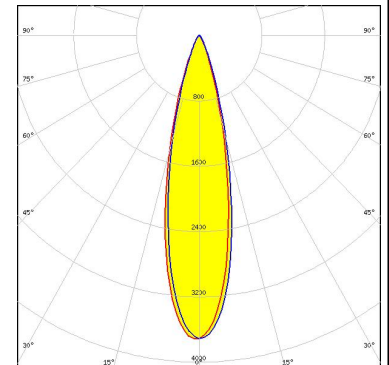

NICHIA

LED NSMx286M
 FWHM 26.0°
 Efficiency 88 %
 Peak intensity 3 cd/lm
 LEDs/each optic 1
 Light colour White
 Required components:

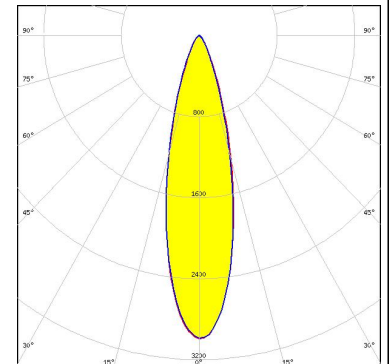

PHOTOMETRIC DATA (MEASURED):

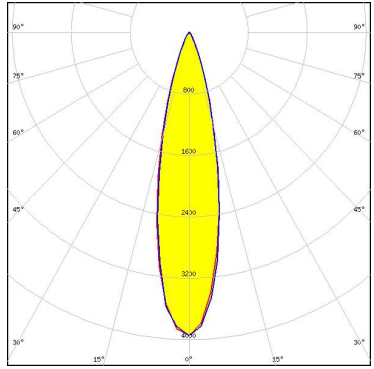
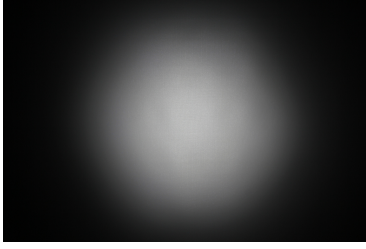
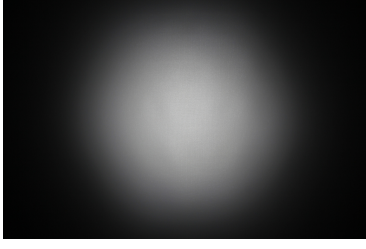
<p>OSRAM Opto Semiconductors</p> <p>LED Duris S8 FWHM 25.0° Efficiency 86 % Peak intensity 4 cd/Im LEDs/each optic 1 Light colour White Required components:</p>		
<p>SEOL SEOUL SEMICONDUCTOR</p> <p>LED Z8Y15 FWHM 24.0° Efficiency 83 % Peak intensity 4.3 cd/Im LEDs/each optic 1 Light colour White Required components:</p>		
<p>SEOL SEOUL SEMICONDUCTOR</p> <p>LED Z8Y19 FWHM 24.0° Efficiency 84 % Peak intensity 4.2 cd/Im LEDs/each optic 1 Light colour White Required components:</p>		

PHOTOMETRIC DATA (SIMULATED):

CITIZEN

LED CLU700/701/702
FWHM 28.0°
Efficiency 93 %
Peak intensity 3.2 cd/lm
LEDs/each optic 1
Light colour White
Required components:

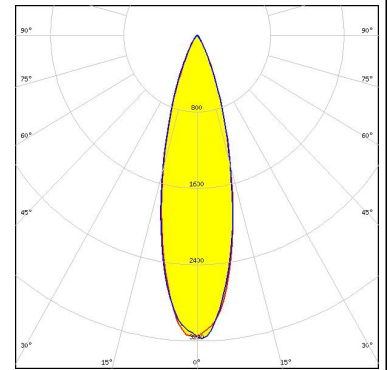

CREE

LED XM-L HVW
FWHM 26.0°
Efficiency %
LEDs/each optic 1
Light colour White
Required components:

LUMILEDS

LED LUXEON 5258
FWHM 24.0°
Efficiency 93 %
Peak intensity 4.3 cd/lm
LEDs/each optic 1
Light colour White
Required components:

LUMINUS

LED CXM-3
FWHM 26.0°
Efficiency 94 %
Peak intensity 4.3 cd/lm
LEDs/each optic 1
Light colour White
Required components:

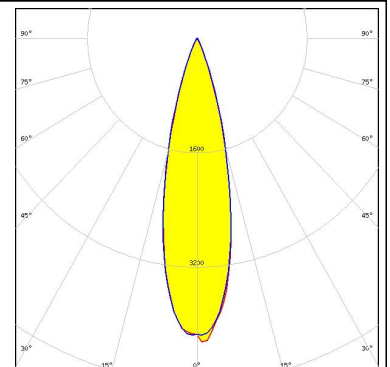

PHOTOMETRIC DATA (SIMULATED):



LED CXM-4
FWHM 26.0°
Efficiency 94 %
Peak intensity 3.8 cd/lm
LEDs/each optic 1
Light colour White
Required components:

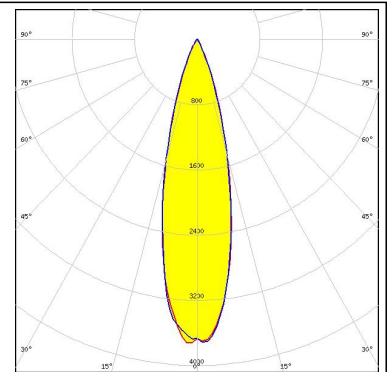

LED OSCONIQ P 7070
FWHM 25.0°
Efficiency 93 %
Peak intensity 3.8 cd/lm
LEDs/each optic 1
Light colour White
Required components:

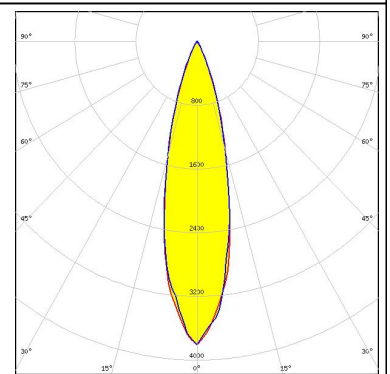

GENERAL INFORMATION:

NOTE: The typical beam angle will be changed by different color, chip size and chip position tolerance. The typical total beam angle is the full angle measured where the luminous intensity is half of the peak value.

Due to use of high power COB's with this product, special attention to proper thermal design is highly recommended. LEDiL has no liability for direct, indirect or consecutive damages arising from the LEDiL products being used outside of the recommended temperature range.

MATERIALS:

As part of our continuous research and improvement processes, and to ensure the best possible quality and availability of our products, LEDiL reserves the right to change material grades without notice.

PRODUCT DATA USER AGREEMENT AND DISCLAIMER:

The measured data in the provided downloadable LEDiL Product Datasheets and Mechanical 2D-Drawings is rounded and provided as reference for planning. LEDiL Oy's optical specifications have been verified by conducting performance testing of the products in accordance with the company's quality system. The reported data are averaged results of multiple measurements with typical variation. LEDiL Oy reserves the right to without prior notification make changes and improvements to its products.

LEDiL Oy assumes neither warranty, nor guarantee nor any other liability of any kind for the contents and correctness of the provided data. The provided data has been generated with highest diligence but the provided data may in reality not represent the complete possible variation range of all intrinsic parameters. Therefore, in certain cases a deviation from the provided data could occur.

LEDiL Oy reserves the right to undertake technical changes of its products without further notification which could lead to changes in the provided data. LEDiL Oy assumes no liability of any kind for the possible deviation from any provided data or any other damage resulting from the usage of the provided data.

The user agrees to this disclaimer and user agreement with the download or usage of the provided files.

LEDiL Oy

Joensuunkatu 13
FI-24240 SALO
Finland

LEDiL Inc.

228 West Page Street
Suite D
Sycamore IL 60178
USA

Local sales and technical support

[www.ledil.com/
where_to_buy](http://www.ledil.com/where_to_buy)

Shipping locations

Salo, Finland
Hong Kong, China

Distribution Partners

[www.ledil.com/
where_to_buy](http://www.ledil.com/where_to_buy)

Компания «Океан Электроники» предлагает заключение долгосрочных отношений при поставках импортных электронных компонентов на взаимовыгодных условиях!

Наши преимущества:

- Поставка оригинальных импортных электронных компонентов напрямую с производств Америки, Европы и Азии, а так же с крупнейших складов мира;
- Широкая линейка поставок активных и пассивных импортных электронных компонентов (более 30 млн. наименований);
- Поставка сложных, дефицитных, либо снятых с производства позиций;
- Оперативные сроки поставки под заказ (от 5 рабочих дней);
- Экспресс доставка в любую точку России;
- Помощь Конструкторского Отдела и консультации квалифицированных инженеров;
- Техническая поддержка проекта, помощь в подборе аналогов, поставка прототипов;
- Поставка электронных компонентов под контролем ВП;
- Система менеджмента качества сертифицирована по Международному стандарту ISO 9001;
- При необходимости вся продукция военного и аэрокосмического назначения проходит испытания и сертификацию в лаборатории (по согласованию с заказчиком);
- Поставка специализированных компонентов военного и аэрокосмического уровня качества (Xilinx, Altera, Analog Devices, Intersil, Interpoint, Microsemi, Actel, Aeroflex, Peregrine, VPT, Syfer, Eurofarad, Texas Instruments, MS Kennedy, Miteq, Cobham, E2V, MA-COM, Hittite, Mini-Circuits, General Dynamics и др.);

Компания «Океан Электроники» является официальным дистрибьютором и эксклюзивным представителем в России одного из крупнейших производителей разъемов военного и аэрокосмического назначения «JONHON», а так же официальным дистрибьютором и эксклюзивным представителем в России производителя высокотехнологичных и надежных решений для передачи СВЧ сигналов «FORSTAR».



JONHON

«JONHON» (основан в 1970 г.)

Разъемы специального, военного и аэрокосмического назначения:

(Применяются в военной, авиационной, аэрокосмической, морской, железнодорожной, горно- и нефтедобывающей отраслях промышленности)

«FORSTAR» (основан в 1998 г.)

ВЧ соединители, коаксиальные кабели, кабельные сборки и микроволновые компоненты:

(Применяются в телекоммуникациях гражданского и специального назначения, в средствах связи, РЛС, а так же военной, авиационной и аэрокосмической отраслях промышленности).



Телефон: 8 (812) 309-75-97 (многоканальный)

Факс: 8 (812) 320-03-32

Электронная почта: ocean@oceanchips.ru

Web: <http://oceanchips.ru/>

Адрес: 198099, г. Санкт-Петербург, ул. Калинина, д. 2, корп. 4, лит. А