

FODM352

Product Preview

Photodarlington Optocoupler with a Base-Emitter Resistor in a 4-Pin Full Pitch Mini-Flat Package

Description

The FODM352 consists of one gallium arsenide (GaAs) infrared light emitting diode, optically coupled to a photodarlington output with a base-emitter resistor, in a compact, mini-flat, 4-pin package. The input-output isolation voltage, V_{ISO} , is rated at 3,750 VAC_{RMS}.

Features

- Current Transfer Ratio Min 1000% at $I_F = 1 \text{ mA}$, $V_{CE} = 2 \text{ V}$, $T_A = 25^\circ\text{C}$
- Safety and Regulatory Approvals:
 - UL1577, 3750 VAC_{RMS} for 1 min
 - DIN EN/IEC60747-5-5, 565 V Peak Working Insulation Voltage
- Applicable to Infrared Reflow, 260°C

Typical Applications

- Power Supply Regulators
- Digital Logic Inputs
- Microprocessor Inputs
- Programmable Controllers

This document contains information on a product under development. ON Semiconductor reserves the right to change or discontinue this product without notice.



ON Semiconductor®

www.onsemi.com

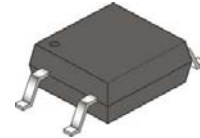

MFP4
CASE 100AP

MARKING DIAGRAM

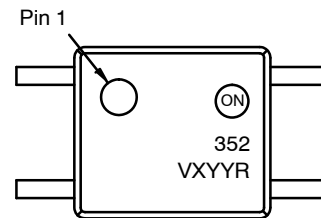

352	= Specific Device Code
V	= DIN EN/IEC60747-5-5 Option
X	= One-Digit Year Code
YY	= Work Week
R	= Assembly Package Code

PIN CONNECTIONS

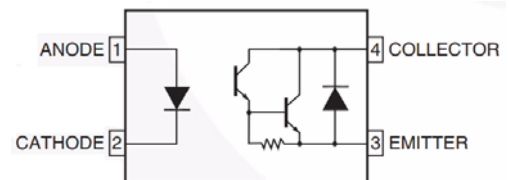

ORDERING INFORMATION

See detailed ordering and shipping information on page 3 of this data sheet.

FODM352

Table 1. SAFETY AND INSULATIONS RATING As per DIN EN/IEC 60747-5-5, this optocoupler is suitable for “safe electrical insulation” only within the safety limit data. Compliance with the safety ratings shall be ensured by means of protective circuits.

Parameter		Characteristics
Installation Classifications per DIN VDE 0110/1.89 Table 1, For Rated Mains Voltage	< 150 V _{RMS}	I-IV
	< 300 V _{RMS}	I-III
Climatic Classification		55/110/21
Pollution Degree (DIN VDE 0110/1.89)		2
Comparative Tracking Index		175

Symbol	Parameter	Value	Unit
V _{PR}	Input-to-Output Test Voltage, Method A, V _{IORM} × 1.6 = V _{PR} , Type and Sample Test with t _m = 10 s, Partial Discharge < 5 pC	904	V _{peak}
	Input-to-Output Test Voltage, Method B, V _{IORM} × 1.875 = V _{PR} , 100% Production Test with t _m = 1 s, Partial Discharge < 5 pC	1060	V _{peak}
V _{IORM}	Maximum Working Insulation Voltage	565	V _{peak}
V _{IOTM}	Highest Allowable Over-Voltage	6,000	V _{peak}
	External Creepage	≥ 5	mm
	External Clearance	≥ 5	mm
DTI	Distance Through Insulation (Insulation Thickness)	≥ 0.4	mm
T _S	Case Temperature (Note 1)	150	°C
I _{S,INPUT}	Input Current (Note 1)	200	mA
P _{S,OUTPUT}	Output Power (Note 1)	300	mW
R _{IO}	Insulation Resistance at T _S , V _{IO} = 500 V (Note 1)	> 10 ⁹	Ω

1. Safety limit values – maximum values allowed in the event of a failure.

Table 2. ABSOLUTE MAXIMUM RATINGS (Note 2) T_A = 25°C unless otherwise specified.

Symbol	Parameter	Value	Units
T _{STG}	Storage Temperature	-55 to +150	°C
T _{OPR}	Operating Temperature	-55 to +110	°C
T _J	Junction Temperature	-55 to +125	°C
T _{SOL}	Lead Solder Temperature (Refer to Reflow Temperature Profile)	260 for 10 sec	°C

EMITTER

I _{F(average)}	Continuous Forward Current	50	mA
V _R	Reverse Input Voltage	6	V
PD _{LED}	Power Dissipation (Note 3)	70	mW

DETECTOR

I _{C(average)}	Continuous Collector Current	150	mA
V _{CEO}	Collector-Emitter Voltage	300	V
V _{ECO}	Emitter-Collector Voltage	0.1	V
PD _C	Collector Power Dissipation (Note 3)	150	mW

Stresses exceeding those listed in the Maximum Ratings table may damage the device. If any of these limits are exceeded, device functionality should not be assumed, damage may occur and reliability may be affected.

2. Stresses exceeding those listed in the Maximum Ratings table may damage the device. If any of these limits are exceeded, device functionality should not be assumed, damage may occur and reliability may be affected.

3. Functional operation under these conditions is not implied. Permanent damage may occur if the device is subjected to conditions outside these ratings.

FODM352

Table 3. ELECTRICAL CHARACTERISTICS $T_A = 25^\circ\text{C}$ unless otherwise specified

Symbol	Parameter	Conditions	Min	Typ	Max	Units
EMITTER						
V_F	Forward Voltage	$I_F = 10\text{ mA}$		1.2	1.4	V
I_R	Reverse Current	$V_R = 4\text{ V}$			10	μA
C_T	Terminal Capacitance	$V = 0\text{ V}, f = 1\text{ kHz}$		30	250	pF

DETECTOR

BV_{CEO}	Collector–Emitter Breakdown Voltage	$I_C = 0.1\text{ mA}, I_F = 0\text{ mA}$	300			V
BV_{ECO}	Emitter–Collector Breakdown Voltage	$I_E = 10\ \mu\text{A}, I_F = 0\text{ mA}$	0.1			V
I_{CEO}	Collector Dark Current	$V_{CE} = 200\text{ V}, I_F = 0\text{ mA}$			200	nA

Product parametric performance is indicated in the Electrical Characteristics for the listed test conditions, unless otherwise noted. Product performance may not be indicated by the Electrical Characteristics if operated under different conditions.

Table 4. TRANSFER CHARACTERISTICS $T_A = 25^\circ\text{C}$ unless otherwise specified

Symbol	Parameter	Conditions	Min	Typ	Max	Units
I_C	Collector Current	$I_F = 1\text{ mA}, V_{CE} = 2\text{ V}$	10			mA
CTR	Current Transfer Ratio	$I_F = 1\text{ mA}, V_{CE} = 2\text{ V}$	1000	5000		%
$V_{CE(SAT)}$	Collector–Emitter Saturation Voltage	$I_F = 20\text{ mA}, I_C = 100\text{ mA}$			1.2	V

Table 5. SWITCHING CHARACTERISTICS $T_A = 25^\circ\text{C}$ unless otherwise specified

Symbol	Parameter	Conditions	Min	Typ	Max	Units
t_R	Output Rise Time (10% –90%)	$I_F = 20\text{ mA}, V_{CC} = 2\text{ V}, R_L = 100\ \Omega$		20	100	μs
t_F	Output Fall Time (90% –10%)	$I_F = 20\text{ mA}, V_{CC} = 2\text{ V}, R_L = 100\ \Omega$		100	300	μs

Table 6. ISOLATION CHARACTERISTICS

Symbol	Parameter	Conditions	Min	Typ	Max	Units
V_{ISO}	Input–Output Isolation Voltage	Freq = 60 Hz, $t = 1.0\text{ min}, I_{I-O} \leq 10\ \mu\text{A}$ (Notes 4, 5)	3,750			$V_{AC_{RMS}}$
R_{ISO}	Isolation Resistance	$V_{I-O} = 500\text{ V}$ (Note 4)	5×10^{10}			Ω
C_{ISO}	Isolation Capacitance	Frequency = 1 MHz		0.6	1.0	pF

4. Device is considered a two terminal device: Pin 1 and 2 are shorted together and Pins 3 and 4 are shorted together.

5. 3,750 $V_{AC_{RMS}}$ for 1 minute duration is equivalent to 4,500 $V_{AC_{RMS}}$ for 1 second duration.

ORDERING INFORMATION

Part Number	Package	Packing Method
FODM352	SOP 4–Pin	Tube (100 units)
FODM352R2	SOP 4–Pin	Tape and Reel (2500 units)
FODM352V	SOP 4–Pin, DIN EN/IEC60747–5–5 Option (pending approval)	Tube (100 units)
FODM352R2V	SOP 4–Pin, DIN EN/IEC60747–5–5 Option (pending approval)	Tape and Reel (2500 units)

†For information on tape and reel specifications, including part orientation and tape sizes, please refer to our Tape and Reel Packaging Specifications Brochure, BRD8011/D.

TYPICAL CHARACTERISTICS

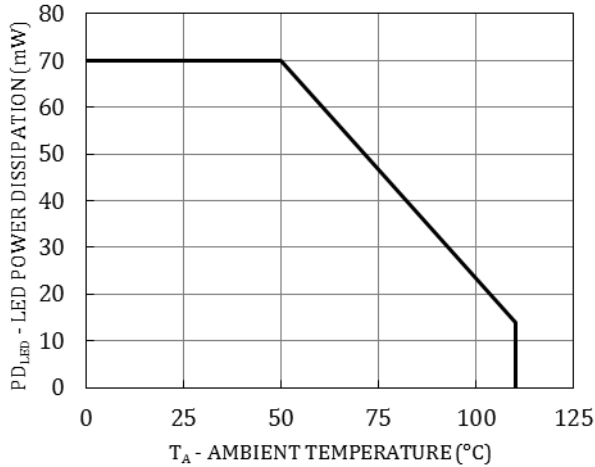

Figure 1. LED Power Dissipation vs. Ambient Temperature

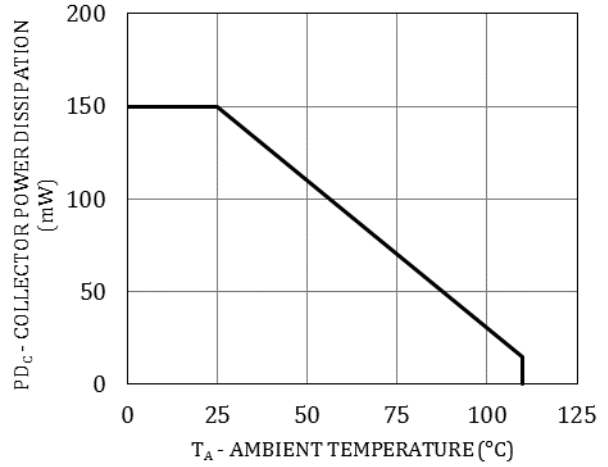

Figure 2. Collector Power Dissipation vs. Ambient Temperature

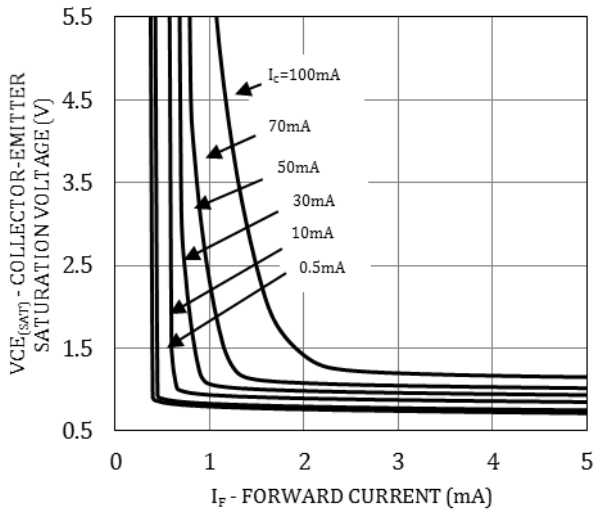

Figure 3. Collector Emitter Saturation Voltage vs. Forward Current

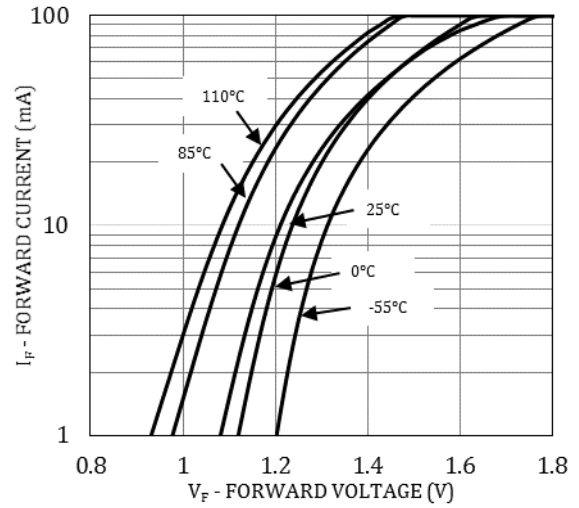

Figure 4. Forward Current vs. Forward Voltage

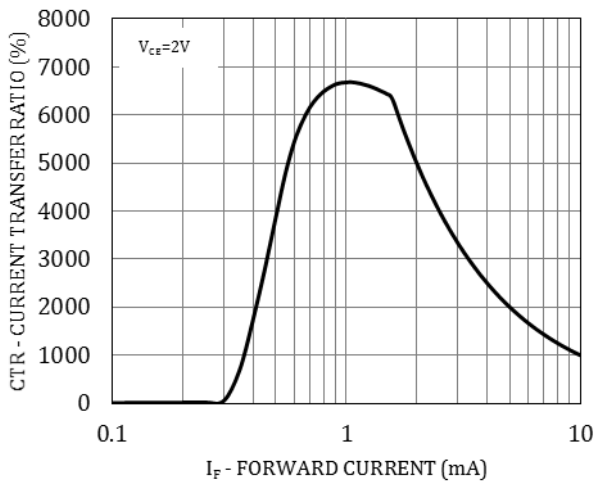

Figure 5. Current Transfer Ratio vs. Forward Current

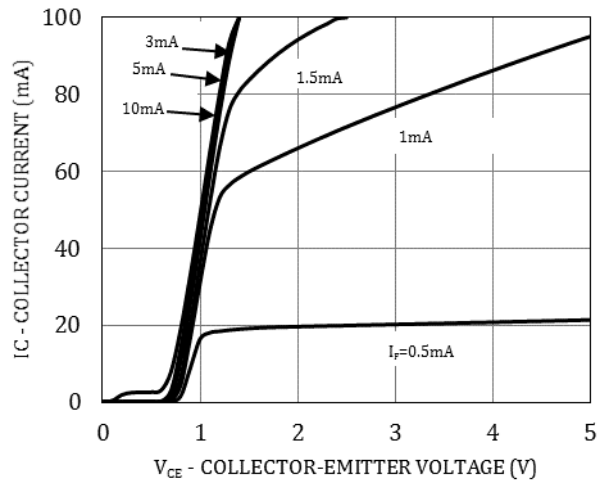

Figure 6. Collector Current vs. Collector Emitter Voltage

TYPICAL CHARACTERISTICS

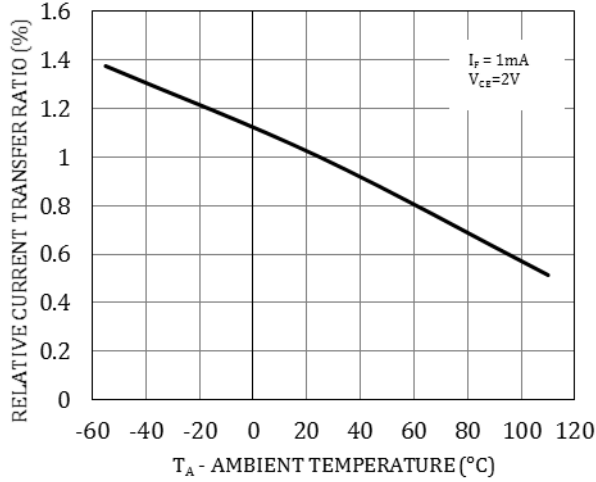

Figure 7. Relative Current Transfer Ratio vs. Ambient Temperature

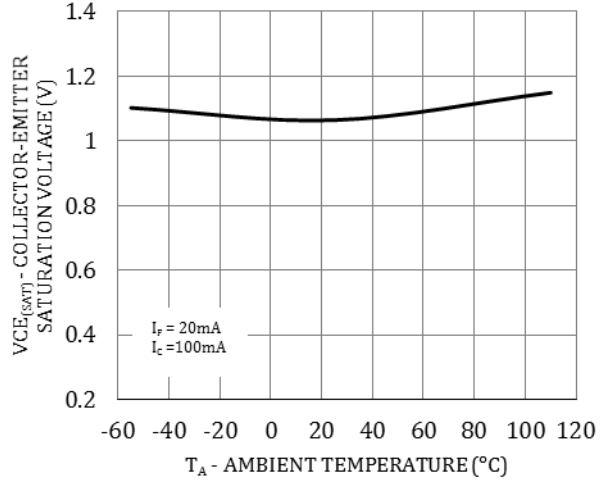

Figure 8. Collector Emitter Saturation Voltage vs. Ambient Temperature

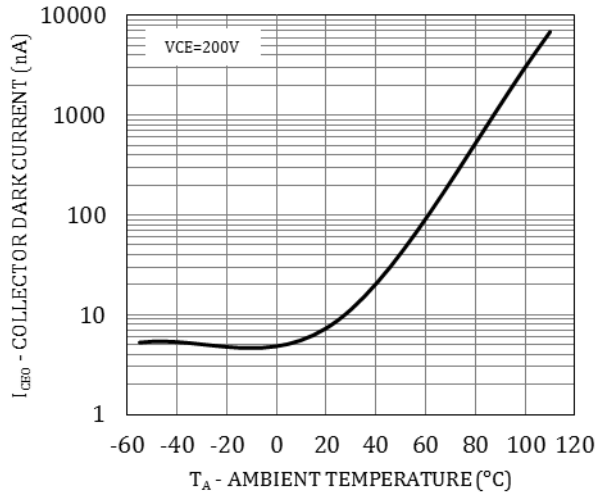

Figure 9. Collector Dark Current vs. Ambient Temperature

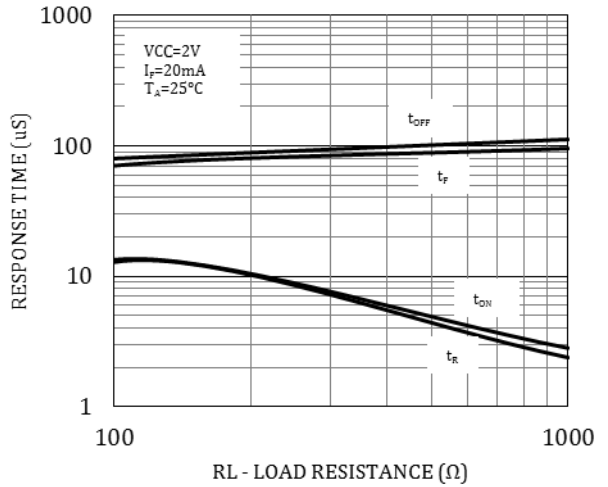

Figure 10. Response Time vs. Load Resistance

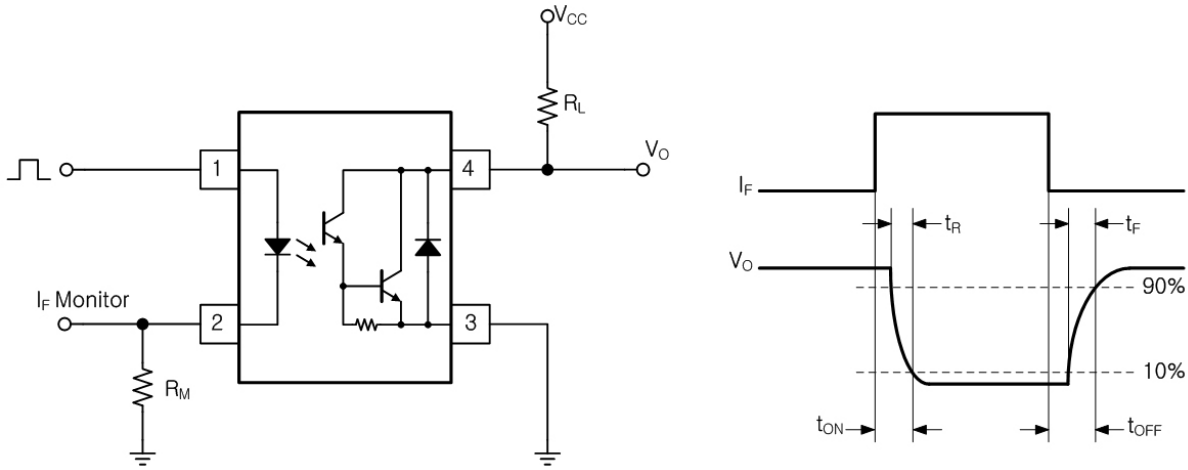

Figure 11. Test Circuit for Switching Time

REFLOW PROFILE

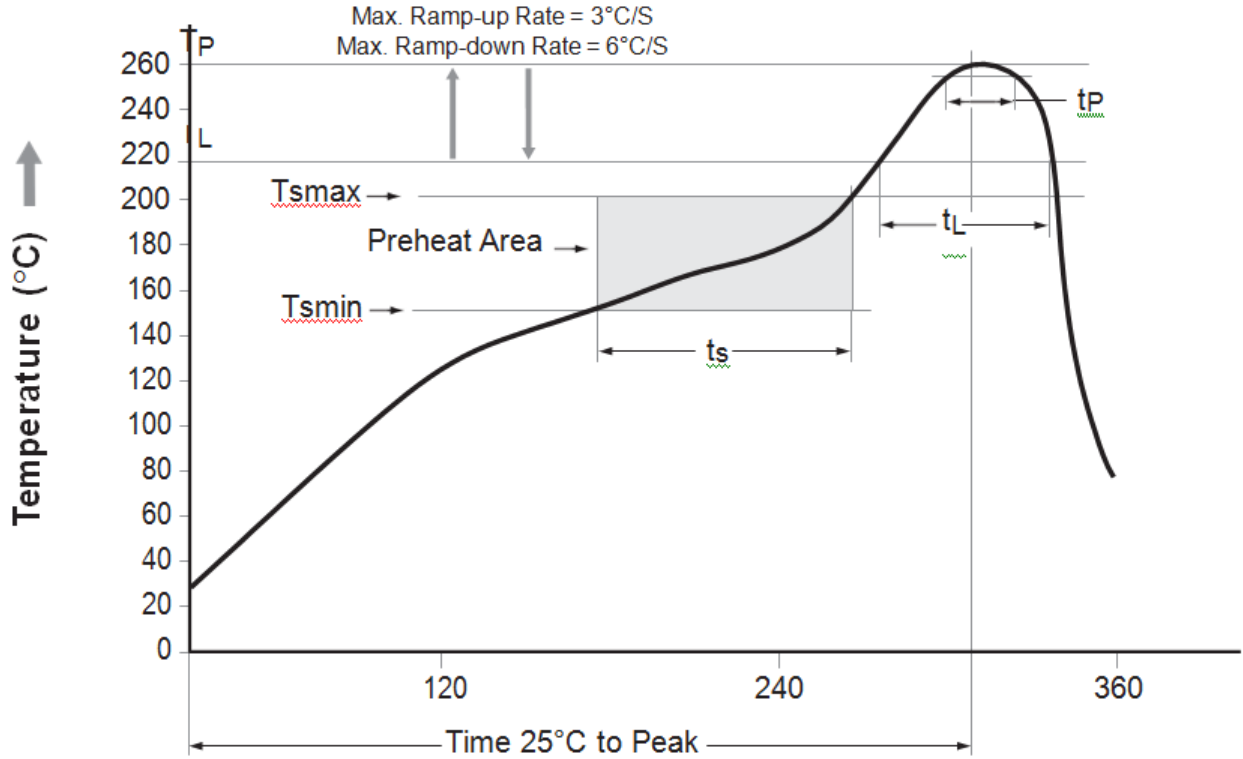

Figure 12. Reflow Profile

Profile Feature	Pb-Free Assembly Profile
Temperature Min. (Tsmín)	150°C
Temperature Max. (Tsmáx)	200°C
Time (ts) from (Tsmín to Tsmáx)	60–120 seconds
Ramp-up Rate (tL to tP)	3°C/second max.
Liquidous Temperature (TL)	217°C
Time (tL) Maintained Above (TL)	60–150 seconds
Peak Body Package Temperature	260°C +0°C / -5°C
Time (tP) within 5°C of 260°C	30 seconds
Ramp-down Rate (TP to TL)	6°C/second max.
Time 25°C to Peak Temperature	8 minutes max.

FODM352

PACKAGE DIMENSIONS

MFP4 3.85X4.4, 2.54P
CASE 100AP
ISSUE O

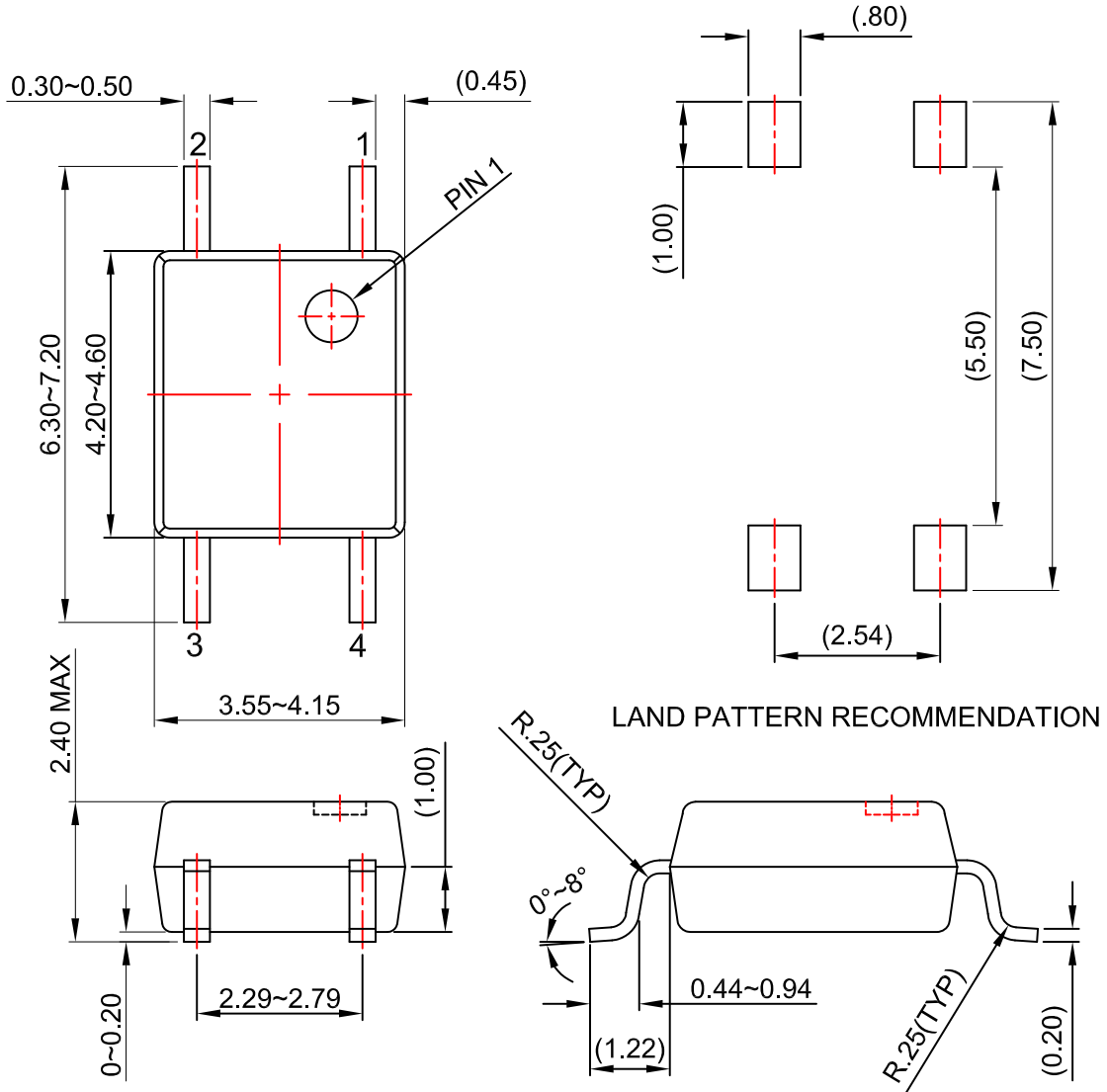

NOTES:

- A) NO STANDARD APPLIES TO THIS PACKAGE.
- B) ALL DIMENSIONS ARE IN MILLIMETERS.
- C) DIMENSIONS ARE EXCLUSIVE OF BURRS, MOLD FLASH, AND TIE BAR EXTRUSION

ON Semiconductor and  are trademarks of Semiconductor Components Industries, LLC dba ON Semiconductor or its subsidiaries in the United States and/or other countries. ON Semiconductor owns the rights to a number of patents, trademarks, copyrights, trade secrets, and other intellectual property. A listing of ON Semiconductor's product/patent coverage may be accessed at www.onsemi.com/site/pdf/Patent-Marking.pdf. ON Semiconductor reserves the right to make changes without further notice to any products herein. ON Semiconductor makes no warranty, representation or guarantee regarding the suitability of its products for any particular purpose, nor does ON Semiconductor assume any liability arising out of the application or use of any product or circuit, and specifically disclaims any and all liability, including without limitation special, consequential or incidental damages. Buyer is responsible for its products and applications using ON Semiconductor products, including compliance with all laws, regulations and safety requirements or standards, regardless of any support or applications information provided by ON Semiconductor. "Typical" parameters which may be provided in ON Semiconductor data sheets and/or specifications can and do vary in different applications and actual performance may vary over time. All operating parameters, including "Typicals" must be validated for each customer application by customer's technical experts. ON Semiconductor does not convey any license under its patent rights nor the rights of others. ON Semiconductor products are not designed, intended, or authorized for use as a critical component in life support systems or any FDA Class 3 medical devices or medical devices with a same or similar classification in a foreign jurisdiction or any devices intended for implantation in the human body. Should Buyer purchase or use ON Semiconductor products for any such unintended or unauthorized application, Buyer shall indemnify and hold ON Semiconductor and its officers, employees, subsidiaries, affiliates, and distributors harmless against all claims, costs, damages, and expenses, and reasonable attorney fees arising out of, directly or indirectly, any claim of personal injury or death associated with such unintended or unauthorized use, even if such claim alleges that ON Semiconductor was negligent regarding the design or manufacture of the part. ON Semiconductor is an Equal Opportunity/Affirmative Action Employer. This literature is subject to all applicable copyright laws and is not for resale in any manner.

PUBLICATION ORDERING INFORMATION

LITERATURE FULFILLMENT:

Literature Distribution Center for ON Semiconductor
19521 E. 32nd Pkwy, Aurora, Colorado 80011 USA
Phone: 303-675-2175 or 800-344-3860 Toll Free USA/Canada
Fax: 303-675-2176 or 800-344-3867 Toll Free USA/Canada
Email: orderlit@onsemi.com

N. American Technical Support: 800-282-9855 Toll Free
USA/Canada
Europe, Middle East and Africa Technical Support:
Phone: 421 33 790 2910

ON Semiconductor Website: www.onsemi.com

Order Literature: <http://www.onsemi.com/orderlit>

For additional information, please contact your local
Sales Representative

Компания «Океан Электроники» предлагает заключение долгосрочных отношений при поставках импортных электронных компонентов на взаимовыгодных условиях!

Наши преимущества:

- Поставка оригинальных импортных электронных компонентов напрямую с производств Америки, Европы и Азии, а так же с крупнейших складов мира;
- Широкая линейка поставок активных и пассивных импортных электронных компонентов (более 30 млн. наименований);
- Поставка сложных, дефицитных, либо снятых с производства позиций;
- Оперативные сроки поставки под заказ (от 5 рабочих дней);
- Экспресс доставка в любую точку России;
- Помощь Конструкторского Отдела и консультации квалифицированных инженеров;
- Техническая поддержка проекта, помощь в подборе аналогов, поставка прототипов;
- Поставка электронных компонентов под контролем ВП;
- Система менеджмента качества сертифицирована по Международному стандарту ISO 9001;
- При необходимости вся продукция военного и аэрокосмического назначения проходит испытания и сертификацию в лаборатории (по согласованию с заказчиком);
- Поставка специализированных компонентов военного и аэрокосмического уровня качества (Xilinx, Altera, Analog Devices, Intersil, Interpoint, Microsemi, Actel, Aeroflex, Peregrine, VPT, Syfer, Eurofarad, Texas Instruments, MS Kennedy, Miteq, Cobham, E2V, MA-COM, Hittite, Mini-Circuits, General Dynamics и др.);

Компания «Океан Электроники» является официальным дистрибьютором и эксклюзивным представителем в России одного из крупнейших производителей разъемов военного и аэрокосмического назначения «**JONHON**», а так же официальным дистрибьютором и эксклюзивным представителем в России производителя высокотехнологичных и надежных решений для передачи СВЧ сигналов «**FORSTAR**».



JONHON

«**JONHON**» (основан в 1970 г.)

Разъемы специального, военного и аэрокосмического назначения:

(Применяются в военной, авиационной, аэрокосмической, морской, железнодорожной, горно- и нефтедобывающей отраслях промышленности)

«**FORSTAR**» (основан в 1998 г.)

ВЧ соединители, коаксиальные кабели,
кабельные сборки и микроволновые компоненты:

(Применяются в телекоммуникациях гражданского и специального назначения, в средствах связи, РЛС, а так же военной, авиационной и аэрокосмической отраслях промышленности).



Телефон: 8 (812) 309-75-97 (многоканальный)

Факс: 8 (812) 320-03-32

Электронная почта: ocean@oceanchips.ru

Web: <http://oceanchips.ru/>

Адрес: 198099, г. Санкт-Петербург, ул. Калинина, д. 2, корп. 4, лит. А