

General Description

The MIC922 is a high-speed operational amplifier with a gain-bandwidth product of 230MHz. The part is unity gain stable. It has a very low 2.5mA supply current, and features the Teeny™ SC-70 package.

Supply voltage range is from $\pm 2.5V$ to $\pm 9V$, allowing the MIC922 to be used in low-voltage circuits or applications requiring large dynamic range.

The MIC922 is stable driving any capacitive load and achieves excellent PSRR and CMRR, making it much easier to use than most conventional high-speed devices. Low supply voltage, low power consumption, and small packing make the MIC922 ideal for portable equipment. The ability to drive capacitive loads also makes it possible to drive long coaxial cables.

Features

- 230MHz gain bandwidth product
- 400MHz $-3dB$ bandwidth
- 2.5mA supply current
- SC-70 package
- 1500V/ μs slew rate
- Drives any capacitive load
- Unity gain stable

Applications

- Video
- Imaging
- Ultrasound
- Portable equipment
- Line drivers

Ordering Information

Part Number				Ambient Temperature	Package
Standard	Marking	Pb-Free	Marking		
MIC922BC5	A39	MIC922YC5	A39	$-40^{\circ}C$ to $+85^{\circ}C$	SC-70-5

Pin Configuration

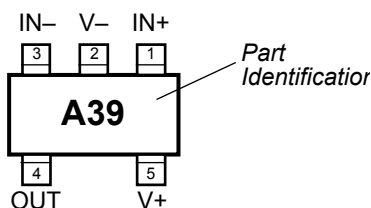

SC-70

Functional Pinout

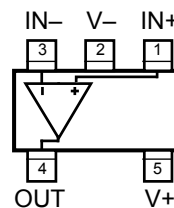

SC-70

Pin Description

Pin Number	Pin Name	Pin Function
1	IN+	Noninverting Input
2	V-	Negative Supply (Input)
3	IN-	Inverting Input
4	OUT	Output: Amplifier Output
5	V+	Positive Supply (Input)

Teeny is a trademark of Micrel, Inc.

Micrel, Inc. • 2180 Fortune Drive • San Jose, CA 95131 • USA • tel + 1 (408) 944-0800 • fax + 1 (408) 474-100 • <http://www.micrel.com>

Absolute Maximum Ratings (Note 1)

Supply Voltage ($V_{V+} - V_{V-}$).....	20V
Differential Input Voltage ($ V_{IN+} - V_{IN-} $).....	4V, Note 3
Input Common-Mode Range (V_{IN+}, V_{IN-}).....	V_{V+} to V_{V-}
Lead Temperature (soldering, 5 sec.).....	260°C
Storage Temperature (T_S).....	150°C
ESD Rating, Note 4	1.5kV

Operating Ratings (Note 2)

Supply Voltage (V_S).....	$\pm 2.5V$ to $\pm 9V$
Junction Temperature (T_J).....	$-40^\circ C$ to $+85^\circ C$
Package Thermal Resistance SC-70-5 (θ_{JA}).....	450°C/W

Electrical Characteristics ($\pm 5V$)

$V_+ = +5V$, $V_- = -5V$, $V_{CM} = 0V$, $R_L = 10M\Omega$; $T_J = 25^\circ C$, **bold** values indicate $-40^\circ C \leq T_J \leq +85^\circ C$; unless noted.

Symbol	Parameter	Condition	Min	Typ	Max	Units
V_{OS}	Input Offset Voltage		-5	0.8	5	mV
V_{OS}	V_{OS} Temperature Coefficient			15		$\mu V/^\circ C$
I_B	Input Bias Current			1.7	4.5	μA
I_{OS}	Input Offset Current		-2	0.3	2	μA
V_{CM}	Input Common-Mode Range		-3.25		+3.25	V
CMRR	Common-Mode Rejection Ratio	$-2.5V < V_{CM} < +2.5V$	75	80		dB
PSRR	Power Supply Rejection Ratio	$\pm 3.5V < V_S < \pm 9V$	68	87		dB
A_{VOL}	Large-Signal Voltage Gain	$R_L = 2k\Omega$, $V_{OUT} = \pm 2V$	65	74		dB
		$R_L = 100\Omega$, $V_{OUT} = \pm 1V$		77		dB
V_{OUT}	Maximum Output Voltage Swing	positive, $R_L = 2k\Omega$	+3	3.6		V
		negative, $R_L = 2k\Omega$		-3.6	-3	V
		positive, $R_L = 100\Omega$	+2.7	3.0		V
		negative, $R_L = 100\Omega$, Note 5		-2.6	-2.3	V
GBW	Unity Gain-Bandwidth Product	$C_L = 1.7pF$		200		MHz
PM	Phase Margin	$C_L = 1.7pF$		49		$^\circ$
BW	-3dB Bandwidth	$A_v = 1$, $C_L = 1.7pF$		320		MHz
SR	Slew Rate	$C = 1.7pF$, Gain=1, $V_{OUT} = 4V_{PP}$ negative SR = 360V/ μs		420		V/ μs
I_{SC}	Short-Circuit Output Current	source	65	78		mA
		sink	40	47		mA
I_S	Supply Current	No Load		2.5	3	mA
	Input Voltage Noise	$f = 10kHz$		9		V/\sqrt{Hz}
	Input Current Noise	$f = 10kHz$		1.1		A/\sqrt{Hz}

Electrical Characteristics

$V_+ = +9V$, $V_- = -9V$, $V_{CM} = 0V$, $R_L = 10M\Omega$; $T_J = 25^\circ C$, **bold** values indicate $-40^\circ C \leq T_J \leq +85^\circ C$; unless noted

Symbol	Parameter	Condition	Min	Typ	Max	Units
V_{OS}	Input Offset Voltage		-5	0.4	5	mV
V_{OS}	Input Offset Voltage Temperature Coefficient			15		$\mu V/^\circ C$
I_B	Input Bias Current			1.7	4.5	μA
I_{OS}	Input Offset Current			0.3	2	μA
V_{CM}	Input Common-Mode Range		-7.25		+7.25	V
CMRR	Common-Mode Rejection Ratio	$-6.5V < V_{CM} < +6.5V$	58	83		dB
PSRR	Power Supply Rejection Ratio	$\pm 3.5V < V_S < \pm 9V$	68	87		dB

Symbol	Parameter	Condition	Min	Typ	Max	Units
A_{VOL}	Large-Signal Voltage Gain	$R_L = 2k\Omega, V_{OUT} = \pm 3V$	65	76		dB
		$R_L = 100\Omega, V_{OUT} = \pm 1V$		86		dB
V_{OUT}	Maximum Output Voltage Swing	positive, $R_L = 2k\Omega$	7	7.5		V
		negative, $R_L = 2k\Omega$		-7.5	-7	V
GBW	Unity Gain-Bandwidth Product	$C_L = 1.7pF$		230		MHz
PM	Phase Margin	$C_L = 1.7pF$		44		°
BW	-3dB Bandwidth	$A_V = 1, C_L = 1.7pF$		400		MHz
SR	Slew Rate	$C = 1.7pF, A_V = 1, V_{OUT} = 8V_{PP}$ positive SR = 750V/ μ s		1500		V/ μ s
I_{SC}	Short-Circuit Output Current	source	70	84		mA
		sink	40	50		mA
I_S	Supply Current	No Load		2.5	3	mA
	Input Voltage Noise	$f = 10kHz$		9		nV/ \sqrt{Hz}
	Input Current Noise	$f = 10kHz$		1.1		pA/ \sqrt{Hz}

Note 1. Exceeding the absolute maximum rating may damage the device.

Note 2. The device is not guaranteed to function outside its operating rating.

Note 3. Exceeding the maximum differential input voltage will damage the input stage and degrade performance (in particular, input bias current is likely to change).

Note 4. Devices are ESD sensitive. Handling precautions recommended. Human body model, 1.5k in series with 100pF.

Note 5. Output swing limited by the maximum output sink capability, refer to the short-circuit current vs. temperature graph in "Typical Characteristics."

Test Circuits

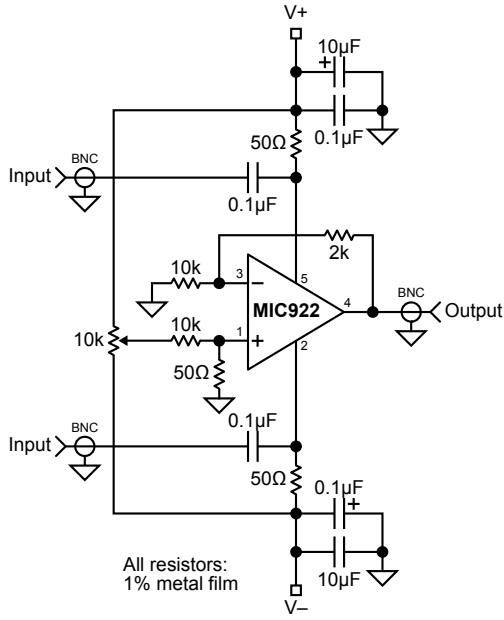

PSRR vs. Frequency

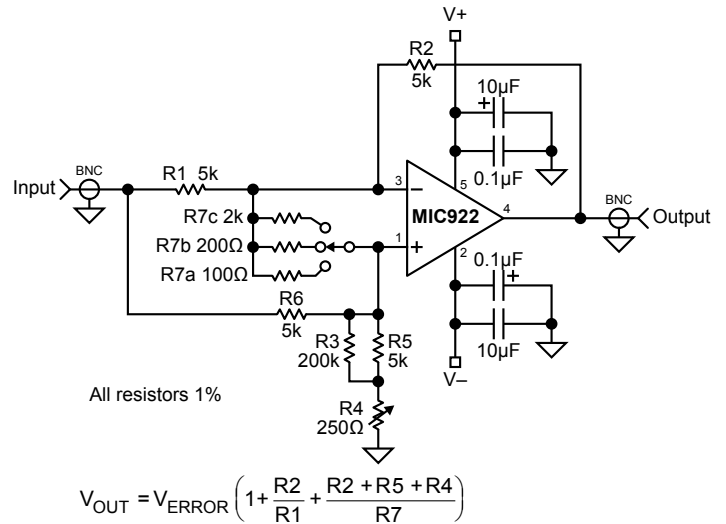

CMRR vs. Frequency

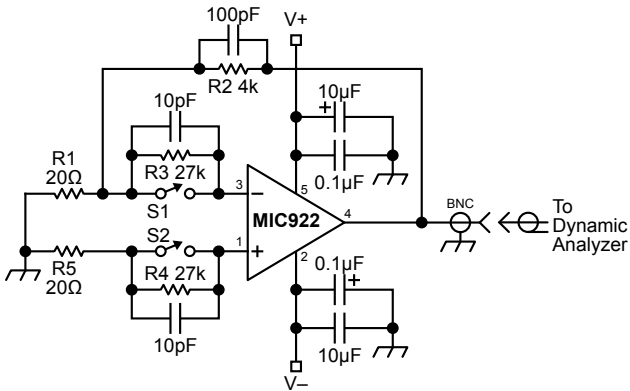

Noise Measurement

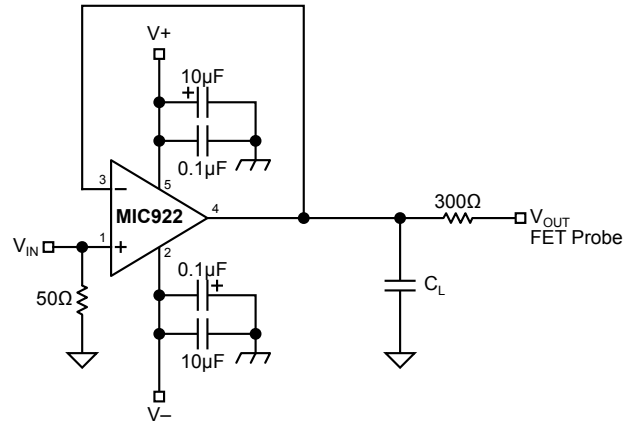

Closed Loop Frequency Response Measurement

Typical Characteristics

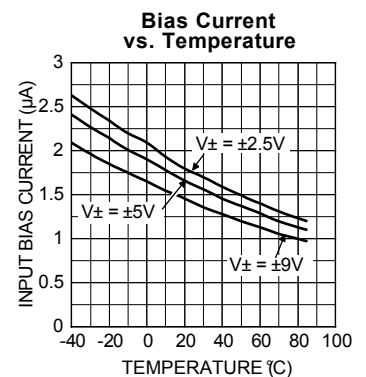
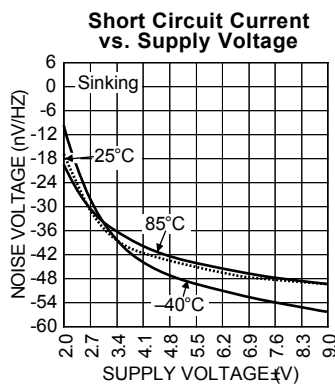
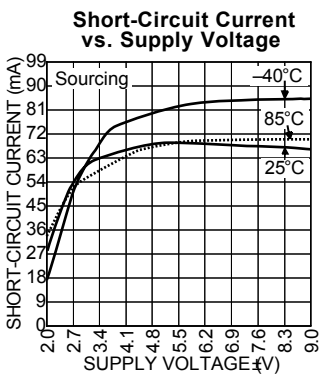
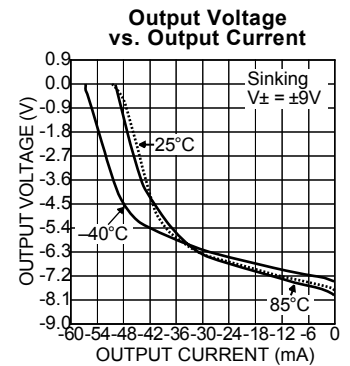
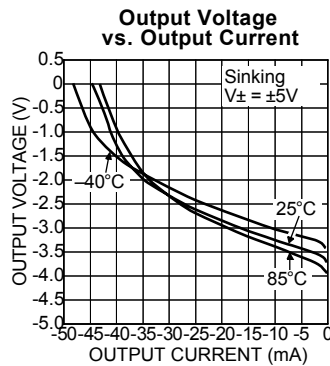
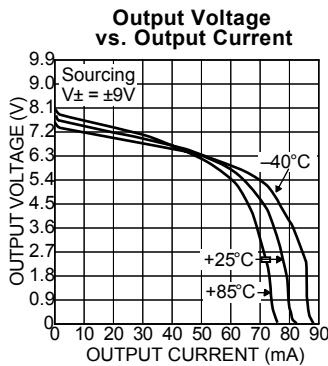
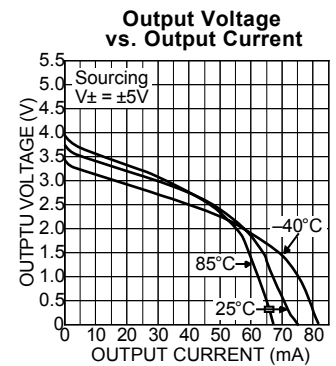
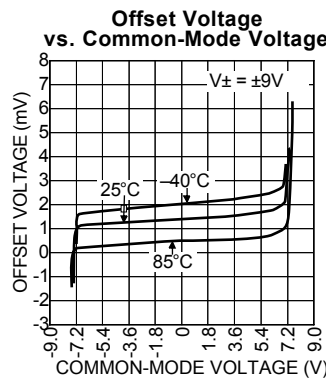
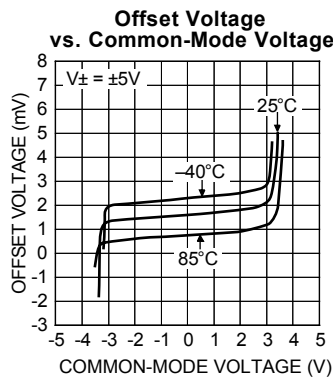
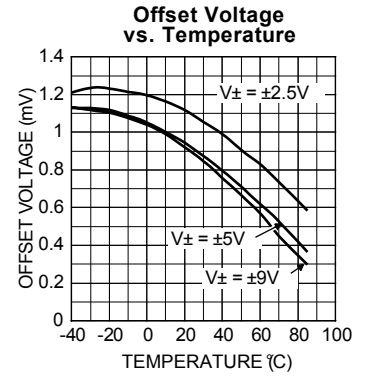
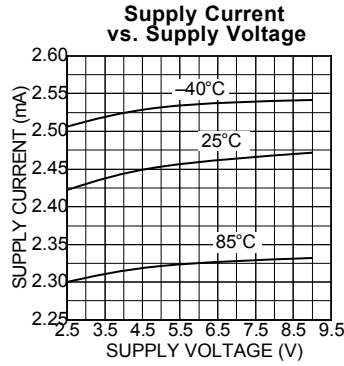
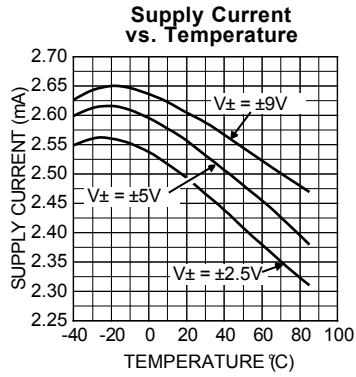

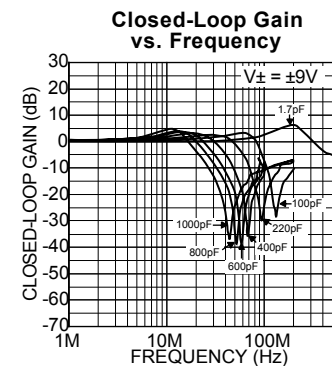
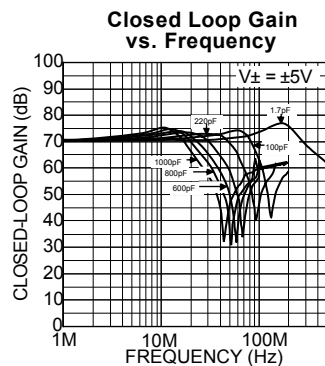
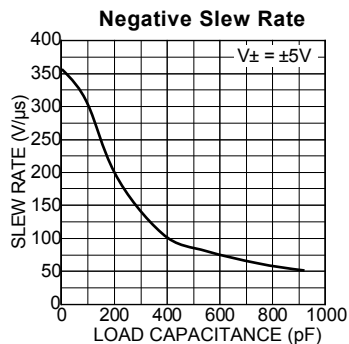
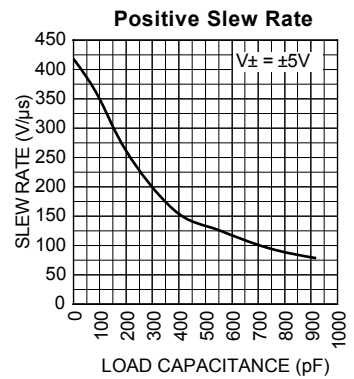
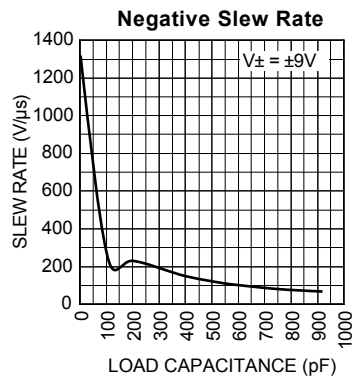
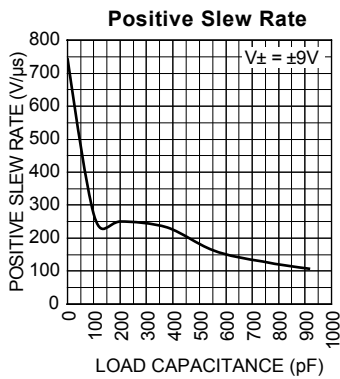
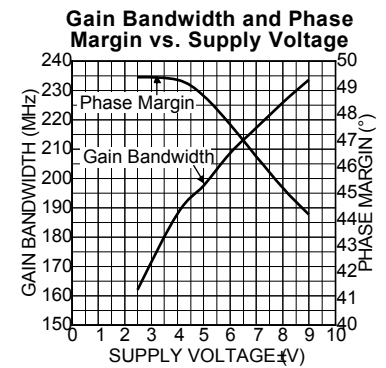
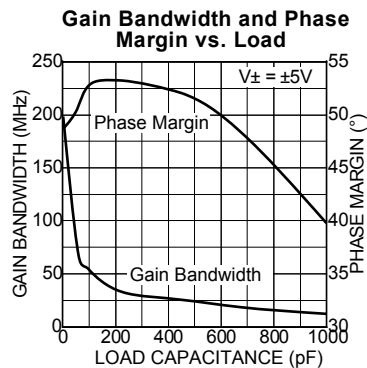
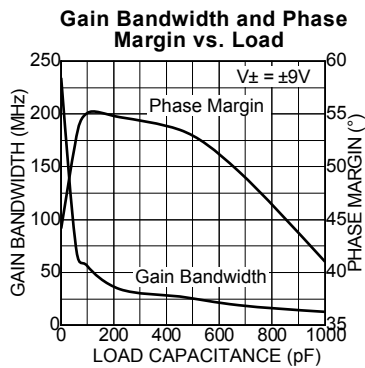
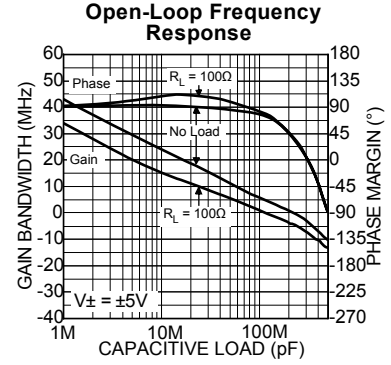
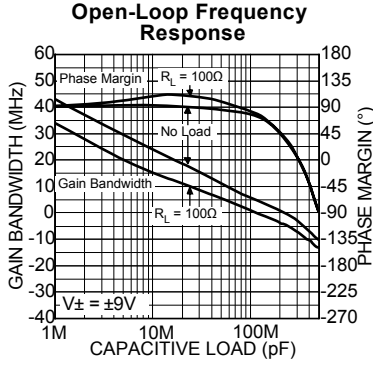
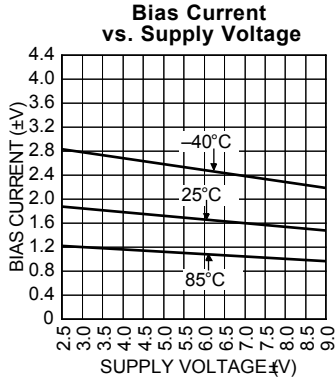

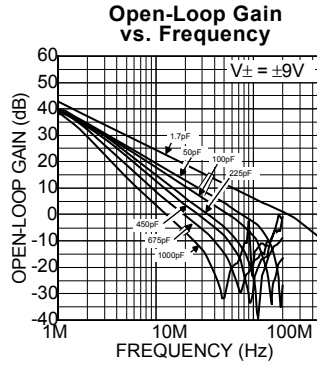
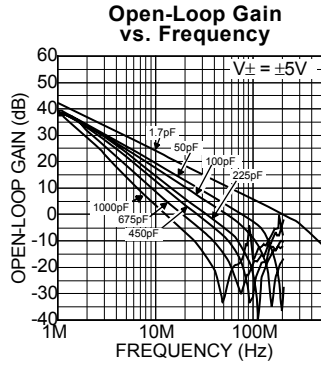

Functional Characteristics

Small Signal Response

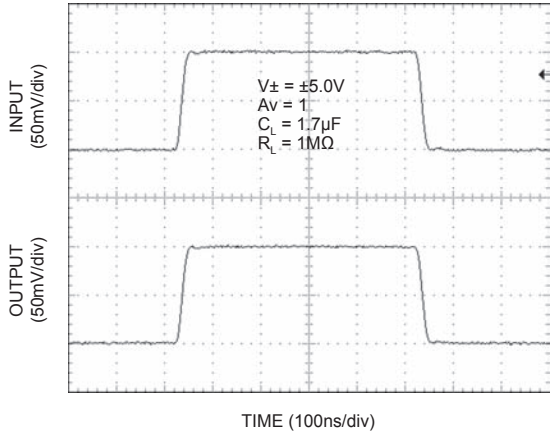

Small Signal Response

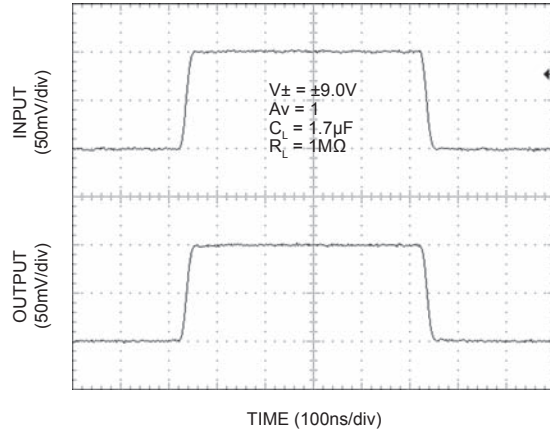

Small Signal Response

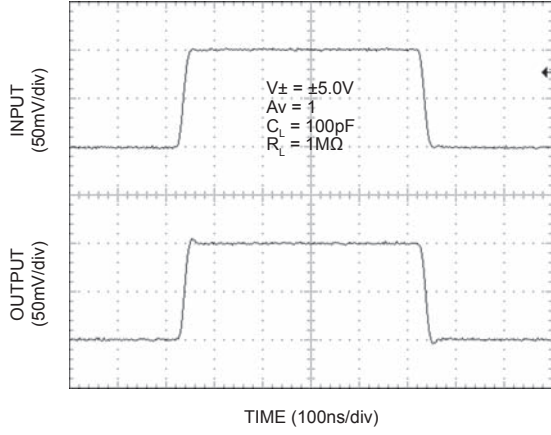

Small Signal Response

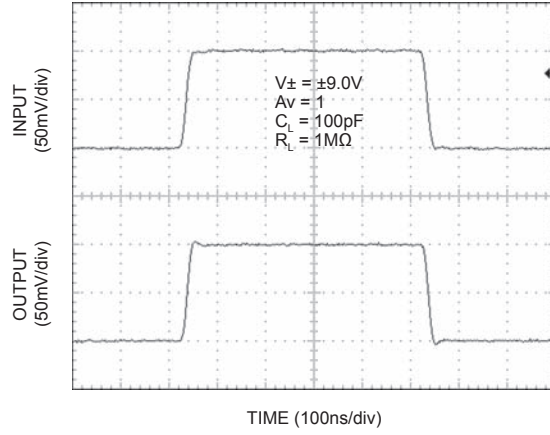

Small Signal Response

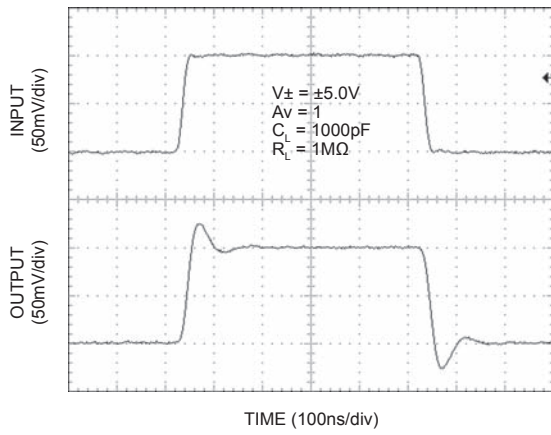

Small Signal Response

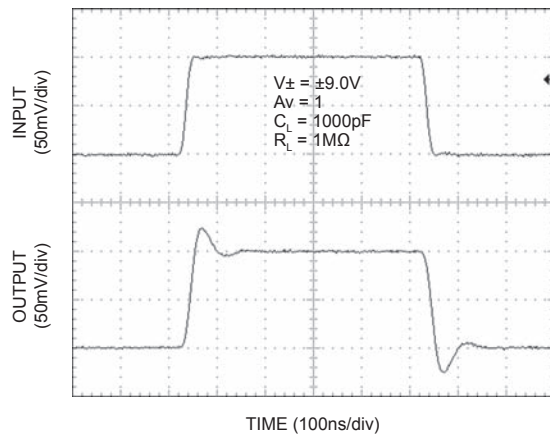

Large Signal Response

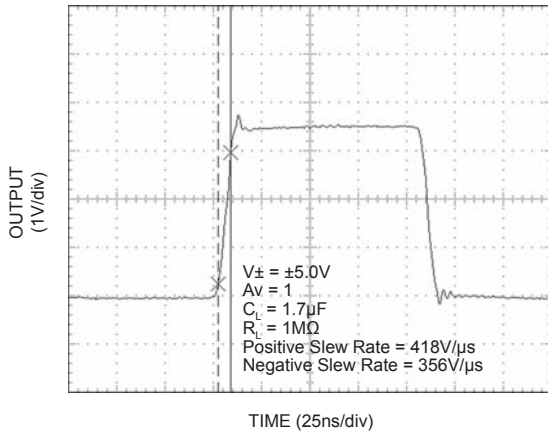

Large Signal Response

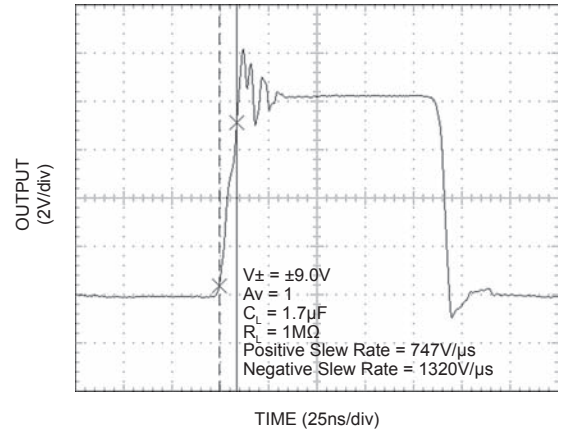

Large Signal Response

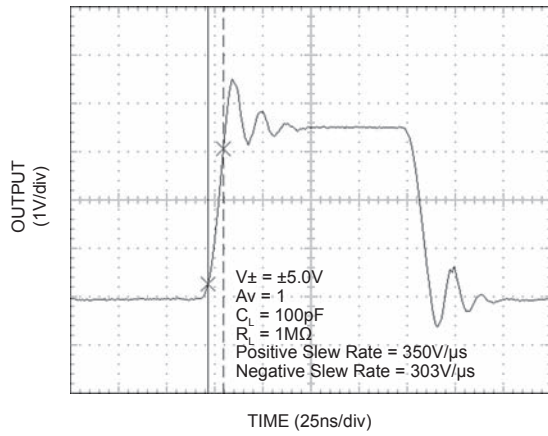

Large Signal Response

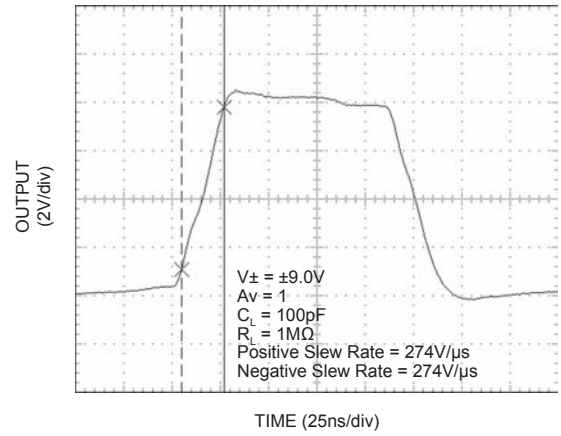

Large Signal Response

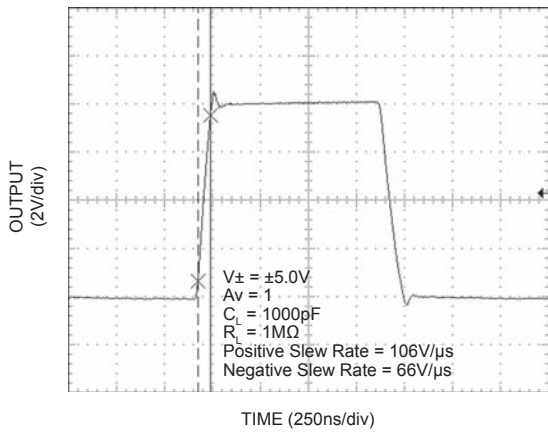

Large Signal Response

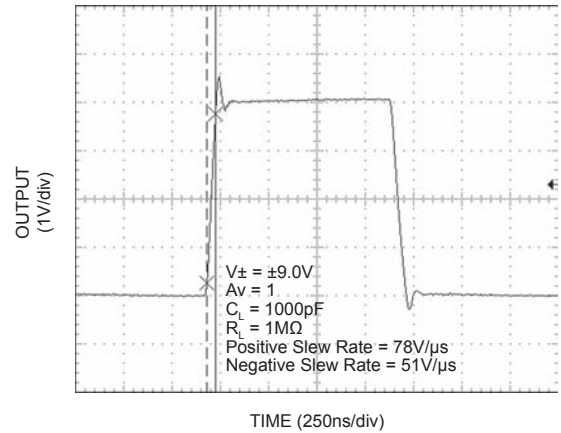

Applications Information

The MIC922 is a high-speed, voltage-feedback operational amplifier featuring very low supply current and excellent stability. This device is unity gain stable, capable of driving high capacitance loads.

Driving High Capacitance

The MIC922 is stable when driving high capacitance, making it ideal for driving long coaxial cables or other high-capacitance loads. Most high-speed op amps are only able to drive limited capacitance.

Note: increasing load capacitance does reduce the speed of the device. In applications where the load capacitance reduces the speed of the op amp to an unacceptable level, the effect of the load capacitance can be reduced by adding a small resistor (<100Ω) in series with the output.

Feedback Resistor/Capacitor Selection

Conventional op amp gain configurations and resistor selection apply, the MIC922 is NOT a current feedback device.

Also, for minimum peaking, the feedback resistor should have low parasitic capacitance. To use the part as a follower, the output should be connected to input via a short wire. At high frequency, the parasitic capacitance at the input might cause peaking in the closed-loop frequency response. A 1pF capacitor should be used across the feedback resistor to compensate for this parasitic peaking.

Layout Considerations

All high speed devices require careful PCB layout. The following guidelines should be observed: Capacitance, particularly on the two inputs pins will degrade performance; avoid large copper traces to the inputs. Keep the output signal away from the inputs and use a ground plane.

It is important to ensure adequate supply bypassing capacitors are located close to the device.

Power Supply Bypassing

Regular supply bypassing techniques are recommended. A 10μF capacitor in parallel with a 0.1μF capacitor on both the positive and negative supplies are ideal. For best performance all bypassing capacitors should be located as close to the op amp as possible and all capacitors should be low ESL (equivalent series inductance), ESR (equivalent series resistance). Surface-mount ceramic capacitors are ideal.

Thermal Considerations

The SC70-5 package, like all small packages, has a high thermal resistance. It is important to ensure the IC does not exceed the maximum operating junction (die) temperature of 85°C. The part can be operated up to the absolute maximum temperature rating of 125°C, but between 85°C and 125°C performance will degrade, in particular CMRR will reduce.

An MIC922 with no load, dissipates power equal to the quiescent supply current × supply voltage

$$P_{D(\text{no load})} = (V_{V+} - V_{V-})I_S$$

When a load is added, the additional power is dissipated in the output stage of the op amp. The power dissipated in the device is a function of supply voltage, output voltage and output current.

$$P_{D(\text{output stage})} = (V_{V+} - V_{VOUT})I_{OUT}$$

$$\text{Total Power Dissipation} = P_{D(\text{no load})} + P_{D(\text{output stage})}$$

Ensure the total power dissipated in the device is no greater than the thermal capacity of the package. The SC70-5 package has a thermal resistance of 450°C/W.

$$\text{Max. Allowable Power Dissipation} = \frac{T_{J(\text{max})} - T_{A(\text{max})}}{450^\circ\text{C/W}}$$

Package Information

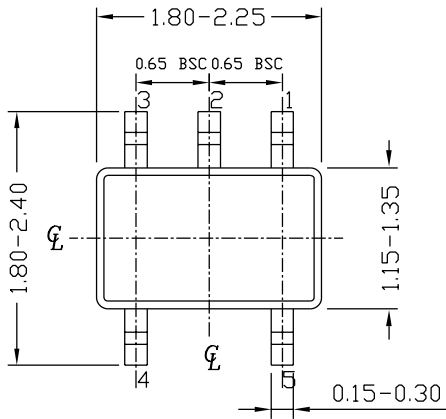

TOP VIEW

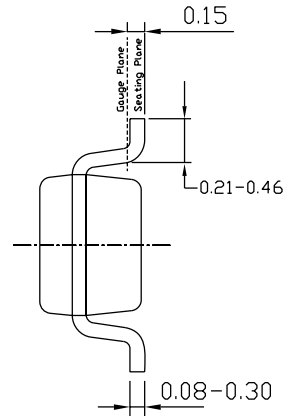

END VIEW

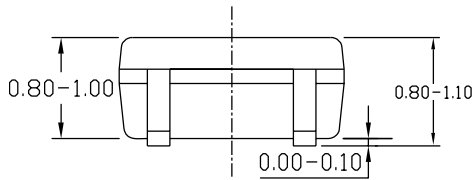

SIDE VIEW

NOTE:

1. ALL DIMENSIONS ARE IN MILLIMETERS.
2. DIMENSIONS ARE INCLUSIVE OF PLATING.
3. DIMENSIONS ARE EXCLUSIVE OF MOLD FLASH & METAL BURR.

SC-70 (C5)

MICREL INC. 2180 FORTUNE DRIVE SAN JOSE, CA 95131 USA
 TEL + 1 (408) 944-0800 FAX + 1 (408) 474-1000 WEB <http://www.micrel.com>

This information furnished by Micrel in this data sheet is believed to be accurate and reliable. However no responsibility is assumed by Micrel for its use. Micrel reserves the right to change circuitry and specifications at any time without notification to the customer.

Micrel Products are not designed or authorized for use as components in life support appliances, devices or systems where malfunction of a product can reasonably be expected to result in personal injury. Life support devices or systems are devices or systems that (a) are intended for surgical implant into the body or (b) support or sustain life, and whose failure to perform can be reasonably expected to result in a significant injury to the user. A Purchaser's use or sale of Micrel Products for use in life support appliances, devices or systems is a Purchaser's own risk and Purchaser agrees to fully indemnify Micrel for any damages resulting from such use or sale.

Компания «Океан Электроники» предлагает заключение долгосрочных отношений при поставках импортных электронных компонентов на взаимовыгодных условиях!

Наши преимущества:

- Поставка оригинальных импортных электронных компонентов напрямую с производств Америки, Европы и Азии, а так же с крупнейших складов мира;
- Широкая линейка поставок активных и пассивных импортных электронных компонентов (более 30 млн. наименований);
- Поставка сложных, дефицитных, либо снятых с производства позиций;
- Оперативные сроки поставки под заказ (от 5 рабочих дней);
- Экспресс доставка в любую точку России;
- Помощь Конструкторского Отдела и консультации квалифицированных инженеров;
- Техническая поддержка проекта, помощь в подборе аналогов, поставка прототипов;
- Поставка электронных компонентов под контролем ВП;
- Система менеджмента качества сертифицирована по Международному стандарту ISO 9001;
- При необходимости вся продукция военного и аэрокосмического назначения проходит испытания и сертификацию в лаборатории (по согласованию с заказчиком);
- Поставка специализированных компонентов военного и аэрокосмического уровня качества (Xilinx, Altera, Analog Devices, Intersil, Interpoint, Microsemi, Actel, Aeroflex, Peregrine, VPT, Syfer, Eurofarad, Texas Instruments, MS Kennedy, Miteq, Cobham, E2V, MA-COM, Hittite, Mini-Circuits, General Dynamics и др.);

Компания «Океан Электроники» является официальным дистрибьютором и эксклюзивным представителем в России одного из крупнейших производителей разъемов военного и аэрокосмического назначения «JONHON», а так же официальным дистрибьютором и эксклюзивным представителем в России производителя высокотехнологичных и надежных решений для передачи СВЧ сигналов «FORSTAR».



JONHON

«JONHON» (основан в 1970 г.)

Разъемы специального, военного и аэрокосмического назначения:

(Применяются в военной, авиационной, аэрокосмической, морской, железнодорожной, горно- и нефтедобывающей отраслях промышленности)

«FORSTAR» (основан в 1998 г.)

ВЧ соединители, коаксиальные кабели, кабельные сборки и микроволновые компоненты:

(Применяются в телекоммуникациях гражданского и специального назначения, в средствах связи, РЛС, а так же военной, авиационной и аэрокосмической отраслях промышленности).



Телефон: 8 (812) 309-75-97 (многоканальный)

Факс: 8 (812) 320-03-32

Электронная почта: ocean@oceanchips.ru

Web: <http://oceanchips.ru/>

Адрес: 198099, г. Санкт-Петербург, ул. Калинина, д. 2, корп. 4, лит. А