

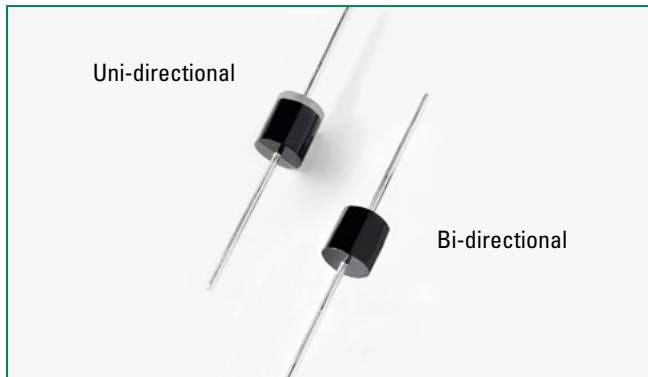

30KPA Series



Agency Approvals

| AGENCY | AGENCY FILE NUMBER |
|---|--------------------|
|  | E230531 |

Maximum Ratings and Thermal Characteristics (T_A=25°C unless otherwise noted)

| Parameter | Symbol | Value | Unit |
|---|-----------------------------------|------------|------|
| Peak Pulse Power Dissipation by 10x1000µs Test Waveform (Fig.1) (Note 1) | P _{PPM} | 30000 | W |
| Steady State Power Dissipation on Infinite Heat Sink at T _L =75°C (Fig. 5) | P _D | 8.0 | W |
| Peak Forward Surge Current, 8.3ms Single Half Sine Wave Unidirectional Only (Note 2) | I _{FSM} | 400 | A |
| Operating Junction and Storage Temperature Range | T _J , T _{STG} | -55 to 175 | °C |
| Typical Thermal Resistance Junction to Lead | R _{WJL} | 8.0 | °C/W |
| Typical Thermal Resistance Junction to Ambient | R _{WJA} | 40 | °C/W |

Notes:

1. Non-repetitive current pulse, per Fig. 4 and derated above T_A = 25°C per Fig. 3.
2. Measured on 8.3ms single half sine wave or equivalent square wave, duty cycle=4 per minute maximum.

Functional Diagram

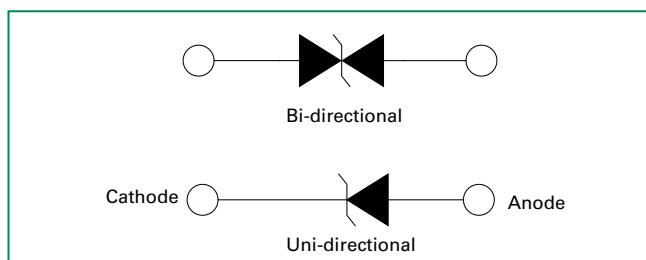

Description

The 30KPA Series is designed specifically to protect sensitive electronic equipment from voltage transients induced by lightning and other transient voltage events.

Features

- Typical maximum temperature coefficient $\Delta V_{BR} = 0.1\% \times V_{BR} @ 25^\circ\text{C} \times \Delta T$
- Glass passivated chip junction in P600 package
- 30000W peak pulse capability at 10x1000µs waveform, repetition rate (duty cycles):0.01%
- Fast response time: typically less than 1.0ps from 0 Volts to BV min
- Excellent clamping capability
- Typical failure mode is short from over-specified voltage or current
- Whisker test is conducted based on JEDEC JESD201A per its table 4a and 4c
- IEC-61000-4-2 ESD 15kV(Air), 8kV (Contact)
- ESD protection of data lines in accordance with IEC 61000-4-2 (IEC801-2)
- EFT protection of data lines in accordance with IEC 61000-4-4 (IEC801-4)
- Low incremental surge resistance
- Typical I_R less than 2µA above 73V
- High temperature soldering guaranteed: 260°C/40 seconds / 0.375"(9.5mm) lead length, 5 lbs., (2.3kg) tension
- Plastic package has underwriters laboratory flammability classification 94V-0
- Matte tin lead-free plated
- Halogen free and RoHS compliant

Applications

TVS devices are ideal for the protection of I/O interfaces, V_{CC} bus and other vulnerable circuits used in telecom, computer, industrial and consumer electronic applications.

Electrical Characteristics ($T_A=25^\circ\text{C}$ unless otherwise noted)

| Part Number (Uni) | Part Number (Bi) | Reverse Stand off Voltage V_R (Volts) | Breakdown Voltage V_{BR} (Volts) @ I_T | Test Current I_T (mA) | Maximum Peak Pulse Current I_{PP} (A) | Maximum Reverse Leakage I_R @ V_R (μA) | Maximum Clamping Voltage V_C @ I_{PP} (V) | Agency Approval  |
|-------------------|------------------|---|--|-------------------------|---|---|---|---|
| | | | MIN | | | | | |
| 30KPA28A | 30KPA28CA | 28 | 31.28 | 50 | 606.0 | 5000 | 50.0 | X |
| 30KPA30A | 30KPA30CA | 30 | 33.51 | 50 | 548.9 | 5000 | 55.2 | X |
| 30KPA33A | 30KPA33CA | 33 | 36.90 | 50 | 517.9 | 5000 | 58.5 | X |
| 30KPA36A | 30KPA36CA | 36 | 40.20 | 50 | 490.3 | 5000 | 61.8 | X |
| 30KPA39A | 30KPA39CA | 39 | 43.60 | 20 | 450.9 | 2000 | 67.2 | X |
| 30KPA42A | 30KPA42CA | 42 | 46.90 | 10 | 420.8 | 1000 | 72.0 | X |
| 30KPA43A | 30KPA43CA | 43 | 48.00 | 10 | 415.1 | 1000 | 73.0 | X |
| 30KPA45A | 30KPA45CA | 45 | 50.30 | 5 | 391.5 | 250 | 77.4 | X |
| 30KPA48A | 30KPA48CA | 48 | 53.60 | 5 | 371.3 | 150 | 81.6 | X |
| 30KPA51A | 30KPA51CA | 51 | 57.00 | 5 | 350.7 | 50 | 86.4 | X |
| 30KPA54A | 30KPA54CA | 54 | 60.30 | 5 | 331.5 | 20 | 91.4 | X |
| 30KPA58A | 30KPA58CA | 58 | 64.80 | 5 | 327.9 | 20 | 92.4 | X |
| 30KPA60A | 30KPA60CA | 60 | 67.00 | 5 | 297.1 | 15 | 102.0 | X |
| 30KPA64A | 30KPA64CA | 64 | 71.50 | 5 | 291.3 | 10 | 104.0 | X |
| 30KPA66A | 30KPA66CA | 66 | 73.70 | 5 | 283.2 | 2 | 107.0 | X |
| 30KPA70A | 30KPA70CA | 70 | 78.20 | 5 | 278.0 | 2 | 109.0 | X |
| 30KPA71A | 30KPA71CA | 71 | 79.30 | 5 | 271.7 | 2 | 111.5 | X |
| 30KPA72A | 30KPA72CA | 72 | 80.40 | 5 | 265.8 | 2 | 114.0 | X |
| 30KPA75A | 30KPA75CA | 75 | 83.80 | 5 | 253.8 | 2 | 119.4 | X |
| 30KPA78A | 30KPA78CA | 78 | 87.10 | 5 | 234.9 | 2 | 129.0 | X |
| 30KPA84A | 30KPA84CA | 84 | 93.80 | 5 | 217.7 | 2 | 139.2 | X |
| 30KPA90A | 30KPA90CA | 90 | 100.50 | 5 | 207.0 | 2 | 146.4 | X |
| 30KPA96A | 30KPA96CA | 96 | 107.20 | 5 | 194.2 | 2 | 156.0 | X |
| 30KPA102A | 30KPA102CA | 102 | 113.90 | 5 | 183.0 | 2 | 165.6 | X |
| 30KPA108A | 30KPA108CA | 108 | 120.60 | 5 | 172.9 | 2 | 175.2 | X |
| 30KPA120A | 30KPA120CA | 120 | 134.00 | 5 | 155.9 | 2 | 194.4 | X |
| 30KPA132A | 30KPA132CA | 132 | 147.40 | 5 | 142.3 | 2 | 213.0 | X |
| 30KPA144A | 30KPA144CA | 144 | 160.80 | 5 | 135.8 | 2 | 223.2 | X |
| 30KPA150A | 30KPA150CA | 150 | 167.60 | 5 | 129.8 | 2 | 233.4 | X |
| 30KPA156A | 30KPA156CA | 156 | 174.30 | 5 | 123.7 | 2 | 245.0 | X |
| 30KPA160A | 30KPA160CA | 160 | 178.70 | 5 | 120.0 | 2 | 252.6 | X |
| 30KPA168A | 30KPA168CA | 168 | 187.70 | 5 | 111.2 | 2 | 272.4 | X |
| 30KPA170A | 30KPA170CA | 170 | 189.90 | 5 | 110.2 | 2 | 275.0 | X |
| 30KPA180A | 30KPA180CA | 180 | 201.10 | 5 | 104.3 | 2 | 290.4 | X |
| 30KPA198A | 30KPA198CA | 198 | 221.20 | 5 | 94.7 | 2 | 319.8 | X |
| 30KPA216A | 30KPA216CA | 216 | 241.30 | 5 | 86.9 | 2 | 348.6 | X |
| 30KPA240A | 30KPA240CA | 240 | 268.10 | 5 | 78.3 | 2 | 387.0 | X |
| 30KPA258A | 30KPA258CA | 258 | 288.20 | 5 | 72.8 | 2 | 416.4 | X |
| 30KPA260A | 30KPA260CA | 260 | 290.40 | 5 | 72.8 | 2 | 416.0 | X |
| 30KPA270A | 30KPA270CA | 270 | 301.60 | 5 | 69.5 | 2 | 436.2 | X |
| 30KPA280A | 30KPA280CA | 280 | 312.80 | 5 | 65.3 | 2 | 464.0 | X |
| 30KPA288A | 30KPA288CA | 288 | 321.70 | 5 | 64.5 | 2 | 469.9 | X |
| 30KPA300A | 30KPA300CA | 300 | 334.00 | 5 | 62.0 | 2 | 484.0 | X |

For bidirectional type having V_{RWM} of 60 volts and less, the I_R limit is double.

For parts without A, the V_{BR} is + 10% and V_C is 5% higher than with A parts.

I-V Curve Characteristics

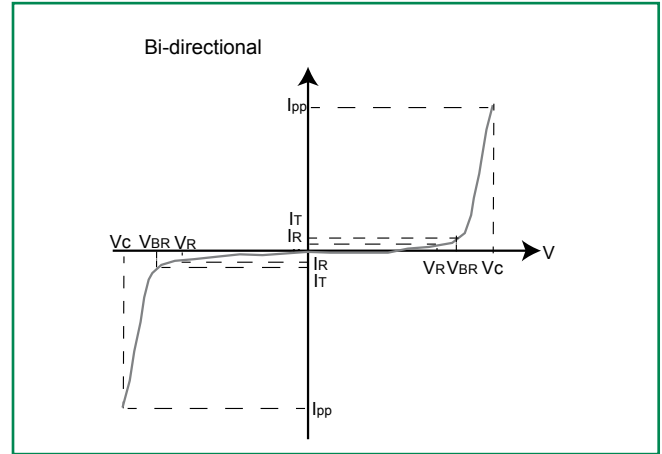
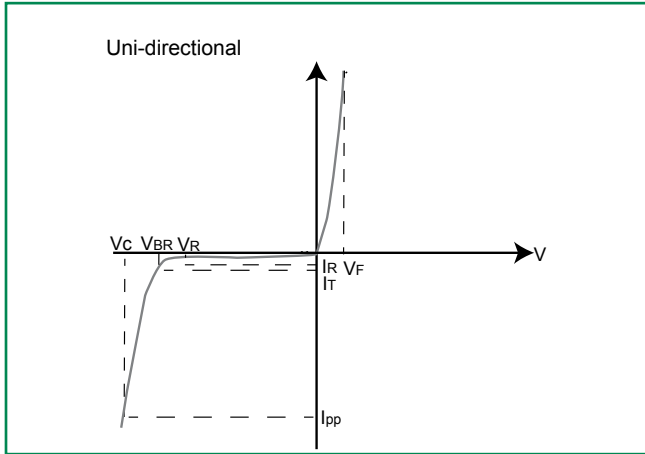

- P_{PPM} Peak Pulse Power Dissipation** – Max power dissipation
- V_R Stand-off Voltage** – Maximum voltage that can be applied to the TVS without operation
- V_{BR} Breakdown Voltage** – Maximum current that flows through the TVS at a specified test current (I_T)
- V_C Clamping Voltage** – Peak voltage measured across the suppressor at a specified I_{ppm} (peak impulse current)
- I_R Reverse Leakage Current** – Current measured at V_R
- V_F Forward Voltage Drop for Uni-directional**

Ratings and Characteristic Curves (T_A=25°C unless otherwise noted)

Figure 1 - TVS Transients Clamping Waveform



Figure 2 - Peak Pulse Power Rating Curve



continues on next page.

Ratings and Characteristic Curves ($T_A=25^\circ\text{C}$ unless otherwise noted) (Continued)

Figure 3 - Pulse Derating Curve



Figure 4 - Pulse Waveform



Figure 5 - Typical Junction Capacitance



Figure 6 - Steady State Power Derating Curve



Figure 7 - Maximum Non-Repetitive Peak Forward Surge Current



Soldering Parameters

| | | |
|--|------------------------------------|-------------------------|
| Reflow Condition | | Lead-free assembly |
| Pre Heat | - Temperature Min ($T_{s(min)}$) | 150°C |
| | - Temperature Max ($T_{s(max)}$) | 200°C |
| | - Time (min to max) (t_s) | 60 – 180 secs |
| Average ramp up rate (Liquidus Temp (T_L) to peak) | | 3°C/second max |
| $T_{s(max)}$ to T_L - Ramp-up Rate | | 3°C/second max |
| Reflow | - Temperature (T_L) (Liquidus) | 217°C |
| | - Time (min to max) (t_s) | 60 – 150 seconds |
| Peak Temperature (T_p) | | 260 ^{+0/-5} °C |
| Time within 5°C of actual peak Temperature (t_p) | | 20 – 40 seconds |
| Ramp-down Rate | | 6°C/second max |
| Time 25°C to peak Temperature (T_p) | | 8 minutes Max. |
| Do not exceed | | 280°C |



Flow/Wave Soldering (Solder Dipping)

| | |
|---------------------------|------------|
| Peak Temperature : | 265°C |
| Dipping Time : | 10 seconds |
| Soldering : | 1 time |

Physical Specifications

| | |
|-----------------|---|
| Weight | 0.07oz., 2.5g |
| Case | P600 molded plastic body over passivated junction. |
| Polarity | Color band denotes the cathode except Bipolar. |
| Terminal | Matte Tin axial leads, solderable per JESD22-B102D. |

Environmental Specifications

| | |
|---------------------------|--------------|
| Temperature Cycle | JESD22-A104 |
| Pressure Cooker | JESD 22-A102 |
| High Temp. Storage | JESD22-A103 |
| HTRB | JESD22-A108 |
| Thermal Shock | JESD22-A106 |

Dimensions



| Dimensions | Inches | | Millimeters | |
|------------|--------|-------|-------------|------|
| | Min | Max | Min | Max |
| A | 1.000 | - | 25.40 | - |
| B | 0.340 | 0.360 | 8.60 | 9.10 |
| C | 0.048 | 0.052 | 1.22 | 1.32 |
| D | 0.340 | 0.360 | 8.60 | 9.10 |

Part Numbering System

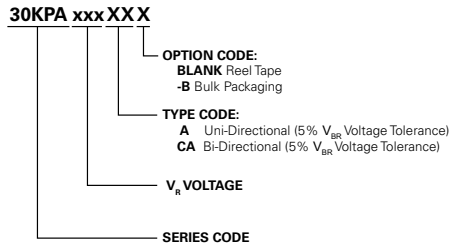

Part Marking System

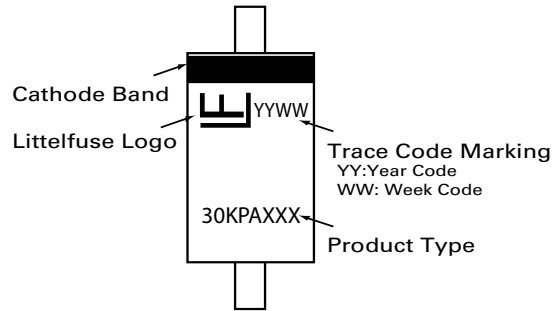

Packing Options

| Part Number | Component Package | Quantity | Packaging Option | Packaging Specification |
|--------------|-------------------|----------|------------------|--|
| 30KPAxxxXX | P600 | 800 | Tape & Reel | EIA STD RS-296E |
| 30KPAxxxXX-B | P600 | 100 | Bulk | Littelfuse Concord Packing Spec. DM-0016 |

Tape and Reel Specification

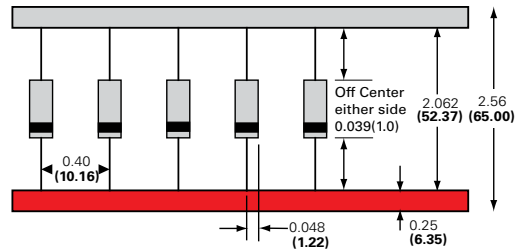

Dimensions are in inches/mm

Компания «Океан Электроники» предлагает заключение долгосрочных отношений при поставках импортных электронных компонентов на взаимовыгодных условиях!

Наши преимущества:

- Поставка оригинальных импортных электронных компонентов напрямую с производств Америки, Европы и Азии, а так же с крупнейших складов мира;
- Широкая линейка поставок активных и пассивных импортных электронных компонентов (более 30 млн. наименований);
- Поставка сложных, дефицитных, либо снятых с производства позиций;
- Оперативные сроки поставки под заказ (от 5 рабочих дней);
- Экспресс доставка в любую точку России;
- Помощь Конструкторского Отдела и консультации квалифицированных инженеров;
- Техническая поддержка проекта, помощь в подборе аналогов, поставка прототипов;
- Поставка электронных компонентов под контролем ВП;
- Система менеджмента качества сертифицирована по Международному стандарту ISO 9001;
- При необходимости вся продукция военного и аэрокосмического назначения проходит испытания и сертификацию в лаборатории (по согласованию с заказчиком);
- Поставка специализированных компонентов военного и аэрокосмического уровня качества (Xilinx, Altera, Analog Devices, Intersil, Interpoint, Microsemi, Actel, Aeroflex, Peregrine, VPT, Syfer, Eurofarad, Texas Instruments, MS Kennedy, Miteq, Cobham, E2V, MA-COM, Hittite, Mini-Circuits, General Dynamics и др.);

Компания «Океан Электроники» является официальным дистрибьютором и эксклюзивным представителем в России одного из крупнейших производителей разъемов военного и аэрокосмического назначения «JONHON», а так же официальным дистрибьютором и эксклюзивным представителем в России производителя высокотехнологичных и надежных решений для передачи СВЧ сигналов «FORSTAR».



JONHON

«JONHON» (основан в 1970 г.)

Разъемы специального, военного и аэрокосмического назначения:

(Применяются в военной, авиационной, аэрокосмической, морской, железнодорожной, горно- и нефтедобывающей отраслях промышленности)

«FORSTAR» (основан в 1998 г.)

ВЧ соединители, коаксиальные кабели,
кабельные сборки и микроволновые компоненты:

(Применяются в телекоммуникациях гражданского и специального назначения, в средствах связи, РЛС, а так же военной, авиационной и аэрокосмической отраслях промышленности).



Телефон: 8 (812) 309-75-97 (многоканальный)

Факс: 8 (812) 320-03-32

Электронная почта: ocean@oceanchips.ru

Web: <http://oceanchips.ru/>

Адрес: 198099, г. Санкт-Петербург, ул. Калинина, д. 2, корп. 4, лит. А