





Messrs. Standard					
Product Specification	Model	NMTC-S40200XFYHSAY-10A	Rev. No.	Issued Date.	Page.
			A.	Sept. 11, 17	1 / 22

LIQUID CRYSTAL DISPLAY MODULE
MODEL: NMTC-S40200XFYHSAY-10A
Customer's No.:

Acceptance

Microtips Technology Inc.
 12F. No.31 Lane 169, Kang Ning St.,
 His-Chih, Taipei Hsien, Taiwan, R.O.C.
 FAX: 886-2-26958625

Approved and Checked by

Approved by	Checked by		Made by
			



Microtips Technology Inc.

Messrs. Standard					
Product Specification	Model	NMTC-S40200XFYHSAY-10A	Rev. No.	Issued Date.	Page.
			A.	Sept. 11, 17	2 / 22

Revise Records

Rev.	Date	Contents	Written	Approved
A.	2017/09/11	See Note1.	Jill Hsu	Danny Lien

Special Notes

Note 1.	The LCD module is compliant with RoHS.
Note 2.	
Note 3.	
Note 4.	
Note 5.	



Messrs. Standard					
Product Specification	Model	NMTC-S40200XFYHSAY-10A	Rev. No.	Issued Date.	Page.
			A.	Sept. 11, 17	3 / 22

CONTENTS

1. General Specifications	4
2. Electrical Specifications	5
2.1 Absolute Maximum Ratings	5
2.2 DC Characteristics	5
2.3 AC Characteristics	6
2.4 Lighting Specifications	8
3. Optical Specifications	9
3.1 LCD Driving Voltage	9
3.2 Optical Characteristics	9
3.3 Definition of Optimum Viewing (Vop)	10
3.4 Definition of Contrast Ratio (CR) and Measuring Condition Definition:	10
3.5 Definition of Response Time and Measuring Condition Definition	11
3.6 Definition of Viewing Angle and Measuring Condition	12
4. I/O Terminal	13
4.1 Pin Assignment	13
4.2 Example of Power Supply	13
4.3 Block Diagram	14
5. Reliability Test	15
5.1 Test Item	15
5.2 Judgment Standard	16
6. Appearance Standards	17
6.1 Inspection Conditions	17
6.2 Definition of Applicable Zones	17
6.3 Standards	18
7. Handling and Precautions	20
8. Warranty	21
9. Dimensional Outlines	21



Messrs. Standard					
Product Specification	Model	NMTC-S40200XFYHSAY-10A	Rev. No.	Issued Date.	Page.
			A.	Sept. 11, 17	4 / 22

1. General Specifications

Operating Temperature.	:	Min. -20°C ~ Max. 70°C
Storage Temperature.	:	Min. -30°C ~ Max. 80°C
Display Format	:	40 characters x 2 lines
Display Fonts	:	5 x 7 dots + cursor (1 character)
Viewing Area	:	154.0 (W) x 16.5 (H) mm
Outline Dimensions	:	182.0 (W) x 33.50 (H) x 14.1 max. (D) mm
Weight	:	N/A
LCD Type	:	STN / Positive Yellow – Green Mode / Transflective
Viewing Direction	:	6:00
Backlight	:	Array type LED (Yellow Green Color)
LCD LSI	:	ST 7066
Drawings	:	As attached drawings



Messrs. Standard					
Product Specification	Model	NMTC-S40200XFYHSAY-10A	Rev. No.	Issued Date.	Page.
			A.	Sept. 11, 17	5 / 22

2. Electrical Specifications

2.1 Absolute Maximum Ratings

$V_{SS} = 0V$

Parameter	Symbol	Conditions	Min.	Max.	Units
Supply Voltage (Logic)	$V_{DD} - V_{SS}$	--	2.7	5.5	V
Supply Voltage (LCD Drive)	$V_{DD} - V_{EE}$	--	4.2	4.6	V
Input Voltage	V_{IN}	--	-0.3	$V_{DD} + 0.3$	V

2.2 DC Characteristics

$T_a = 25^\circ C, V_{SS} = 0V$

Parameter	Symbol	Conditions	Min.	Typ.	Max.	Units
Supply Voltage (Logic)	$V_{DD} - V_{SS}$	--	2.7	4.5	5.5	V
Supply Voltage (LCD Drive)	$V_{DD} - V_{EE}$	Shown in 3.1				V
High Level Input Voltage	V_{IH}	$V_{DD} = 5.0V \pm 10\%$	2.2	--	V_{DD}	V
Low Level Input Voltage	V_{IL}	$V_{DD} = 5.0V \pm 10\%$	0	--	0.6	V
High Level Output Voltage	V_{OH}	$I_{OH} = -0.205mA$	2.4	--	V_{DD}	V
Low Level Output Voltage	V_{OL}	$I_{OL} = 1.2mA$	0	--	0.4	V
Supply Current	I_{DD}	$V_{DD} - V_{SS} = 5.0V$	--	1.5	3.0	mA



Microtips Technology Inc.

Messrs. Standard					
Product Specification	Model	NMTC-S40200XFYHSAY-10A	Rev. No.	Issued Date.	Page.
			A.	Sept. 11, 17	6 / 22

2.3 AC Characteristics

$V_{DD} = 5.0V \pm 10\%$

Parameter	Symbol	Conditions	Min.	Max.	Units
Enable Cycle Time	t_{CYC}	Fig.1, 2	500	--	ns
Enable Pulse Width	PW_{EH}	Fig.1, 2	230	--	ns
Enable Rise / Fall Time	t_{Er}, t_{Ef}	Fig.1, 2	--	20	ns
Address Setup Time	t_{AS}	Fig.1, 2	40	--	ns
Address Hold Time	t_{AH}	Fig.1, 2	10	--	ns
Write Data Setup Time	t_{DSW}	Fig.1	80	--	ns
Write Data Hold Time	t_{DHW}	Fig.1	10	--	ns
Read Data Delay Time	t_{DDR}	Fig.2	--	160	ns
Read Data Hold Time	t_{DHR}	Fig.2	5	--	ns



Messrs. Standard			Rev. No.	Issued Date.	Page.
Product Specification	Model	NMTC-S40200XFYHSAY-10A	A.	Sept. 11, 17	7 / 22

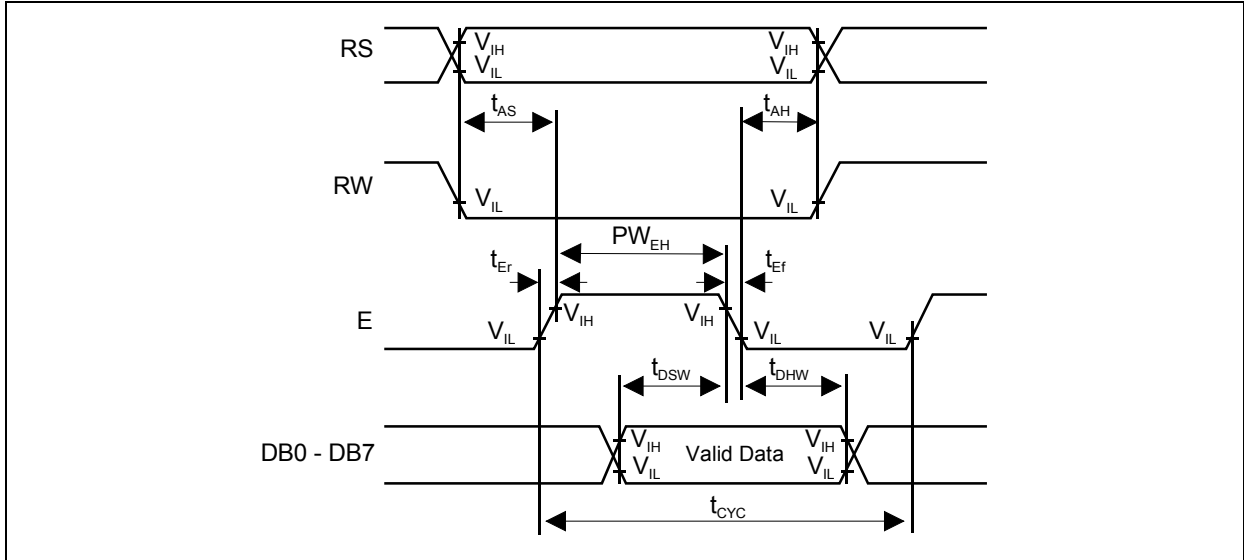

Fig.1 Write Operation Timing

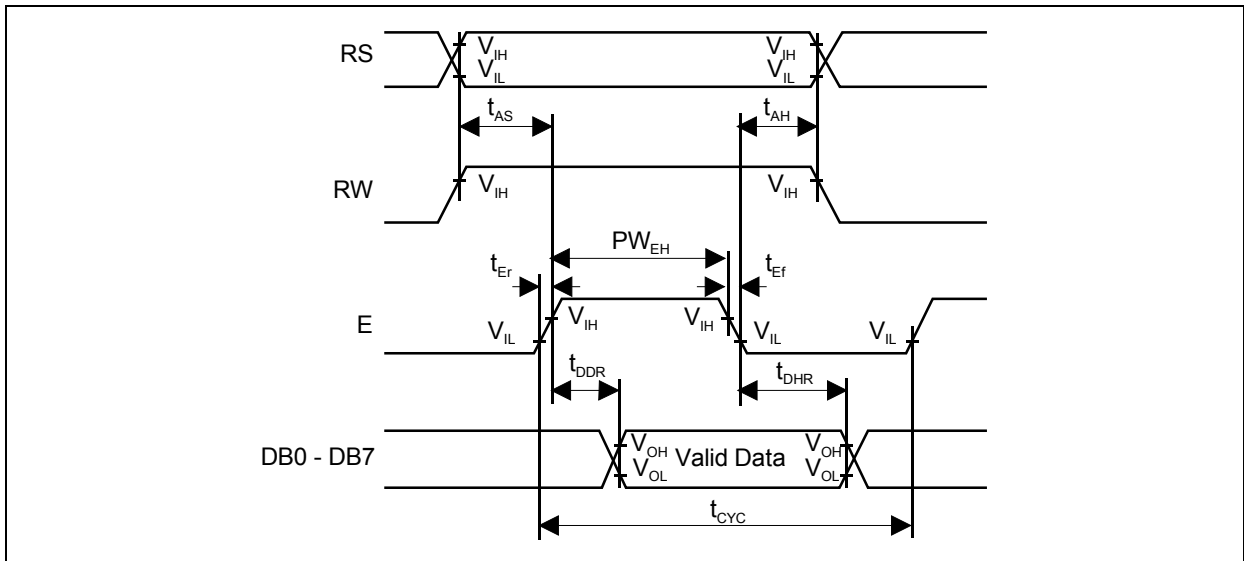

Fig.2 Read Operation Timing



Messrs. Standard					
Product Specification	Model	NMTC-S40200XFYHSAY-10A	Rev. No.	Issued Date.	Page.
			A.	Sept. 11, 17	8 / 22

2.4 Lighting Specifications

2.4.1 Absolute Maximum Ratings

Ta = 25°C

Parameter	Symbol	Conditions	Max.	Units
Forward Current	I _F	--	585	mA
Reverse Voltage	V _R	--	8.0	V
LED Power Dissipation	P _D	--	2.5	W

2.4.2 Operating Characteristics

Ta = 25°C

Parameter	Symbol	Conditions	Min.	Typ.	Max.	Units
Forward Voltage	V _F	I _F = 390mA	--	4.1	4.3	V
Reverse Current	I _R	V _R = 8V	--	--	0.2	mA
Peak Emission Wavelength (Note1)	λ _p	I _F = 390mA	--	568	--	nm
Luminance of Backlight Surface	L	I _F = 390mA	150	200	--	cd/m ²
Luminous Tolerance (Note 2)	--	I _F = 390mA	--	--	50	%

Note 1: Source Color: Yellow Green

Note 2: Luminance tolerance = (Max. – Min. / Max.) x 100%.

Note 3: The driving condition above is based on Backlight A, K.

2.4.3 Schematics Related

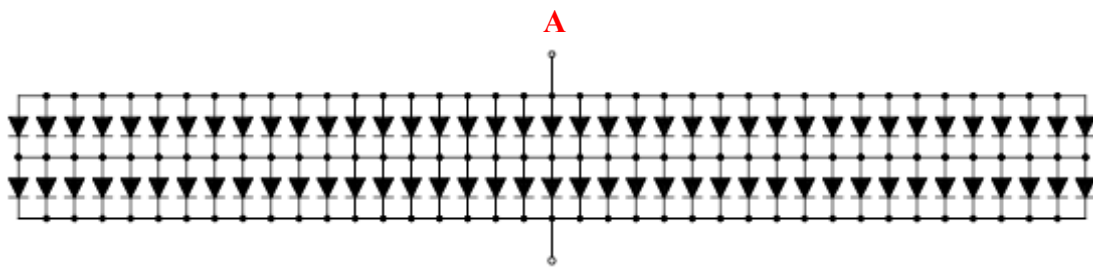

2 x 39 = 78 DICE NUMBERS



Microtips Technology Inc.

Messrs. Standard					
Product Specification	Model	NMTC-S40200XFYHSAY-10A	Rev. No.	Issued Date.	Page.
			A.	Sept. 11, 17	9 / 22

3. Optical Specifications

3.1 LCD Driving Voltage

Parameter	Symbol	Conditions	Min.	Typ.	Max.	Units
Recommended LCD Driving Voltage Note 1	$V_{DD} - V_O$	Ta = -20 °C	4.48	4.78	5.08	V
		Ta = 25 °C	4.20	4.50	4.80	V
		Ta = 70 °C	3.92	4.22	4.50	V

Note 1: Voltage (Applied actual waveform to LCD Module) for the best contrast. The range of minimum and maximum shows tolerance of the operating voltage. The specified contrast ratio and response time are not guaranteed over the entire range.

3.2 Optical Characteristics

Ta = 25 °C, 1/16 Duty, 1/5 Bias, (Note 4), $\theta = 0^\circ$, $\phi = 0^\circ$

Parameter	Symbol	Conditions	Min.	Typ.	Max.	Units	
Contrast Ratio Note 2	CR	Ta = 25 °C	2.0	6.0	--	--	
Viewing Angle (Shown in 3.3) Note 4	Front – Back	$\theta_2 - \theta_1$	Ta = 25 °C	30	107	--	deg.
	Left – Right	$\phi_2 - \phi_1$					
Response Time	Rise Note 3	T_{ON}	Ta = 25 °C	--	90	250	ms
	Decay Note 3	T_{OFF}	Ta = 25 °C	--	110	260	ms

Note 1: Contrast ratio is defined as follows.

$$CR = L_{OFF} / L_{ON}$$

L_{ON} : Luminance of the ON segments, L_{OFF} : Luminance of the OFF segments

Note 2: The time that the luminance level reaches 90% of the saturation level from 0% when ON signal is applied.

Note 3: The time that the luminance level reaches 10% of the saturation level from 100% when OFF signal is applied.

Note 4: Definition of Driving Voltage V_D . Assuming that the typical driving waveforms shown below are applied to the LCD Panel at 1/A Duty – 1/B Bias (A: Duty Number, B: Bias Number). Driving voltage V_D is defined as follows: $V_D = (V_{th1} + V_{th2}) / 2$

V_{th1} : The voltage VO-P that should provide 50% of the saturation level in the luminance at the segment which the ON signal is applied to.

V_{th2} : The voltage VO-P that should provide 50% of the saturation level in the luminance at the segment which the OFF signal is applied to.

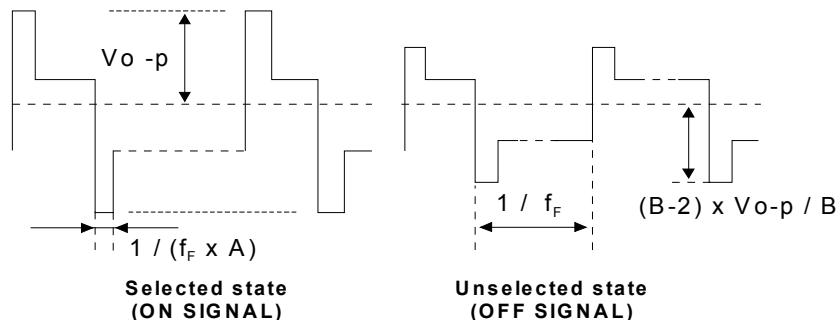

Messrs. Standard					
Product Specification	Model	NMTC-S40200XFYHSAY-10A	Rev. No.	Issued Date.	Page.
			A.	Sept. 11, 17	10 / 22

3.3 Definition of Optimum Viewing (Vop)

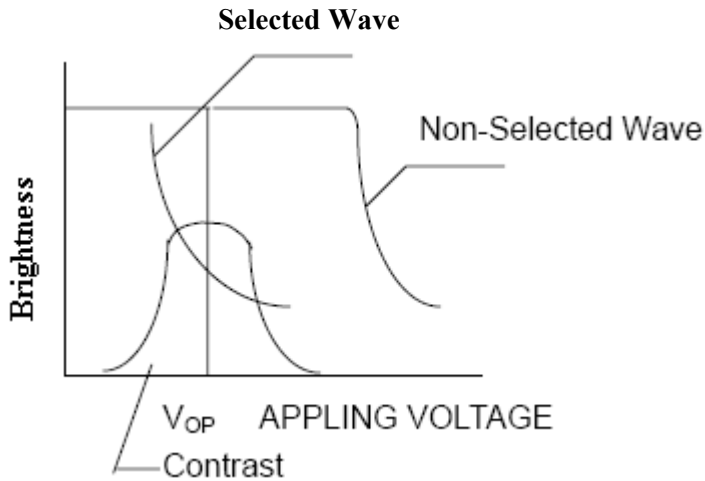

Conditions:

A: Vop
 Temperature: REF: Electro-Optical
 Viewing Angle (θ): 0
 Frame Frequency: 64Hz
 Appling Waveform: 1/ Duty. 1/ Bias
 Contrast: MAX

3.4 Definition of Contrast Ratio (CR) and Measuring Condition Definition:

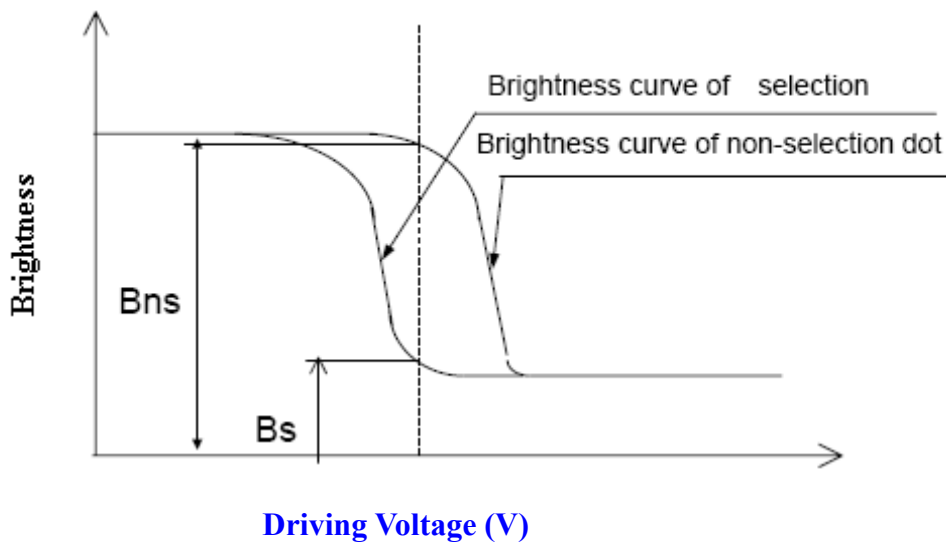

Condition:

Frame Frequency: 64Hz
 Viewing Angle (θ): 30 deg
 (θ is definition as in note2)
 Operating Voltage (Vop): 4.5V



Microtips Technology Inc.

Messrs. Standard					
Product Specification	Model	NMTC-S40200XFYHSAY-10A	Rev. No.	Issued Date.	Page.
			A.	Sept. 11, 17	11 / 22

3.5 Definition of Response Time and Measuring Condition Definition:

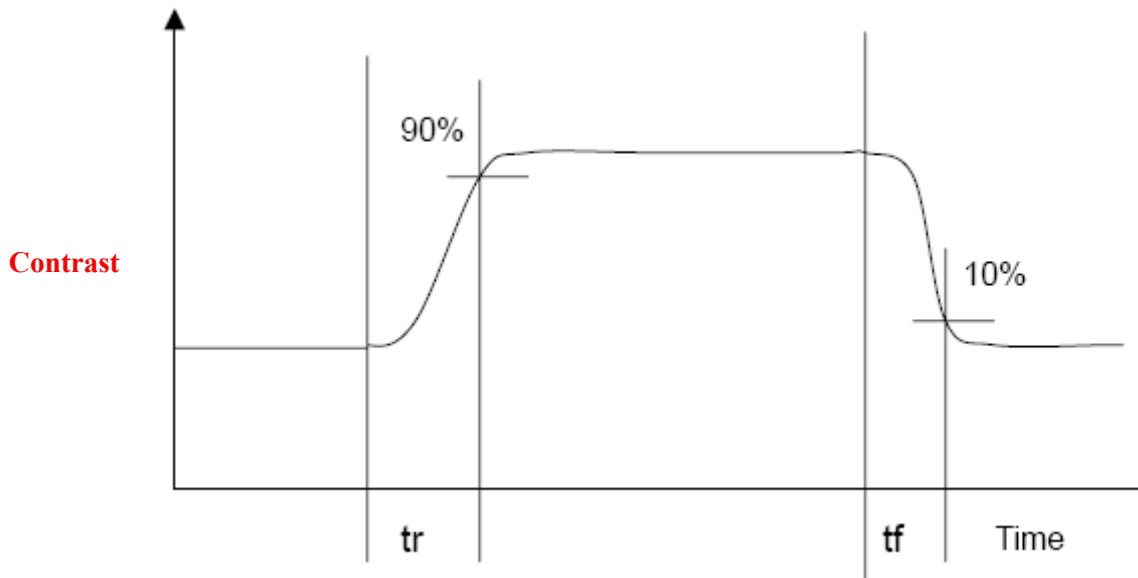
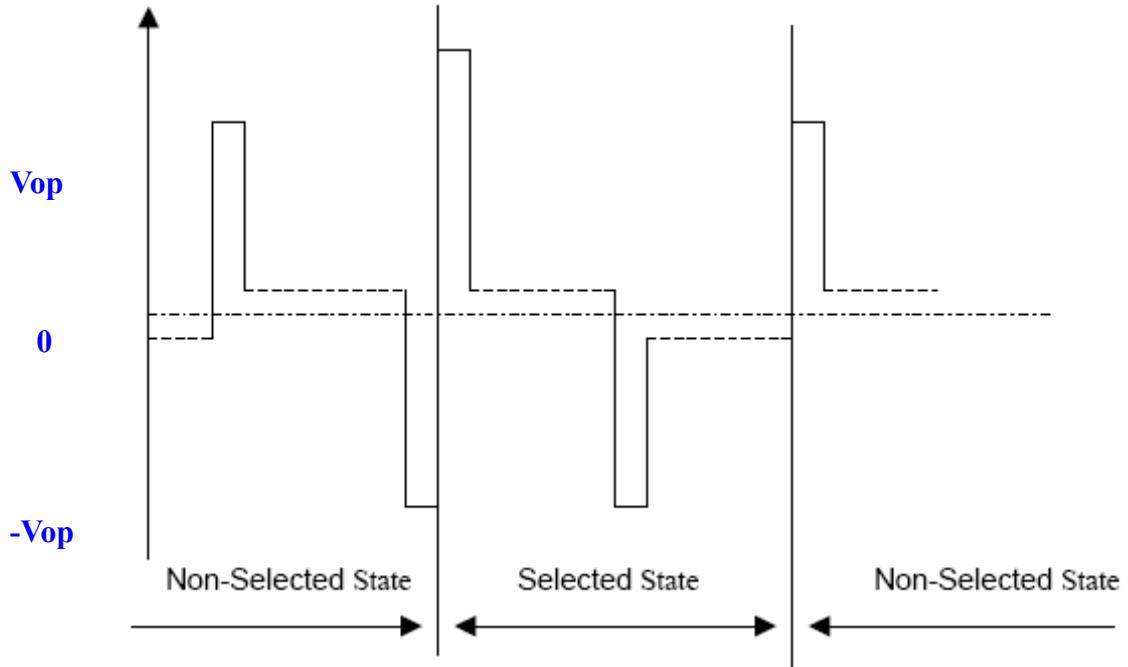

Condition:

Frame Frequency: 64Hz

Viewing Angle (θ): 0 deg (θ is definition as in note2)

Operating Voltage (V_{op}): 4.5V



Microtips Technology Inc.

Messrs. Standard					
Product Specification	Model	NMTC-S40200XFYHSAY-10A	Rev. No.	Issued Date.	Page.
			A.	Sept. 11, 17	12 / 22

3.6 Definition of Viewing Angle and Measuring Condition

Definition of θ and ϕ

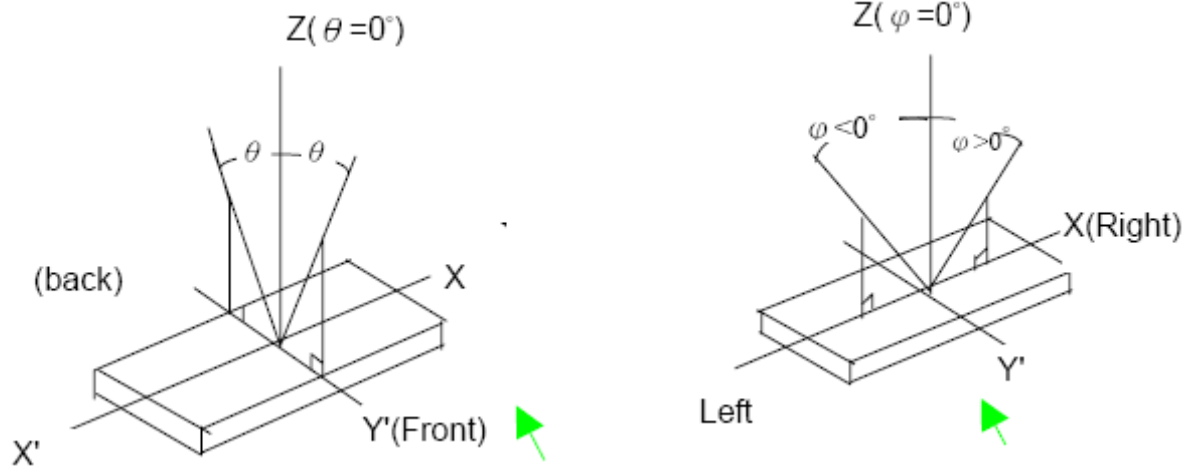

Definition of viewing angles $\theta 1, \theta 2, \phi 1,$ and $\phi 2$

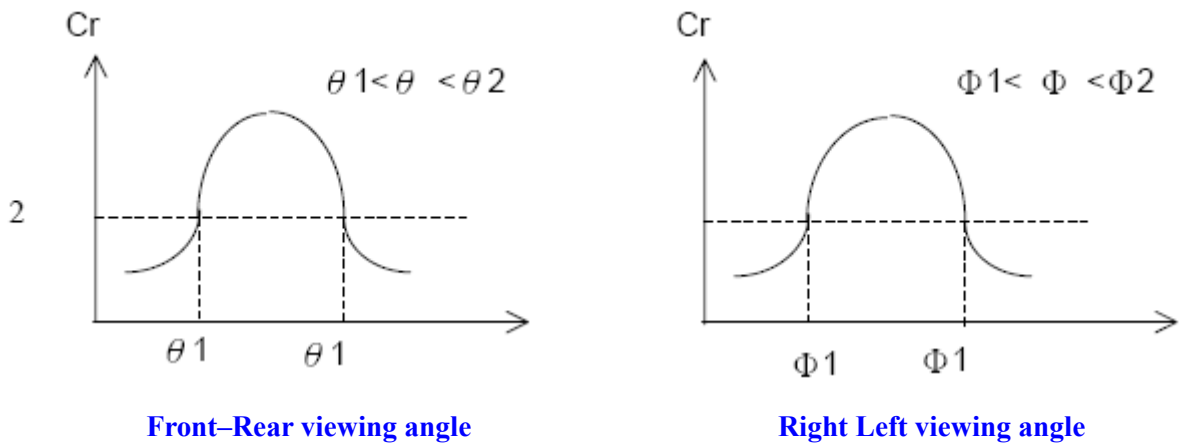

Condition:

Frame Frequency: 64Hz

Operating Voltage (Vop): 4.5V



Microtips Technology Inc.

Messrs. Standard					
Product Specification	Model	NMTC-S40200XFYHSAY-10A	Rev. No.	Issued Date.	Page.
			A.	Sept. 11, 17	13 / 22

4. I/O Terminal

4.1 Pin Assignment

No.	Symbol	Level	Function
1.	VSS	--	Power Supply (0V, GND)
2.	VDD	--	Power Supply for Logic
3.	VEE (Vo)	--	Power Supply for LCD Drive
4.	RS	H / L	Register Select Signal
5.	R/W	H / L	Read / Write Select Signal H: Read L: Write
6.	E	H / L	Enable Signal (No pull – up Resister)
7.	DB0	H / L	Data Bus Line / Non – connection at 4 – bit operation
8.	DB1	H / L	Data Bus Line / Non – connection at 4 – bit operation
9.	DB2	H / L	Data Bus Line / Non – connection at 4 – bit operation
10.	DB3	H / L	Data Bus Line / Non – connection at 4 – bit operation
11.	DB4	H / L	Data Bus Lin
12.	DB5	H / L	Data Bus Line
13.	DB6	H / L	Data Bus Line
14.	DB7	H / L	Data Bus Line
15.	LEDA	--	Power Supply for Backlight / LED Anode (+)
16.	LEDK	--	Power Supply for Backlight / LED Cathode (-)

4.2 Example of Power Supply

It is recommended to apply a potentiometer for the contrast adjust due to the tolerance of the driving voltage and its temperature dependence.

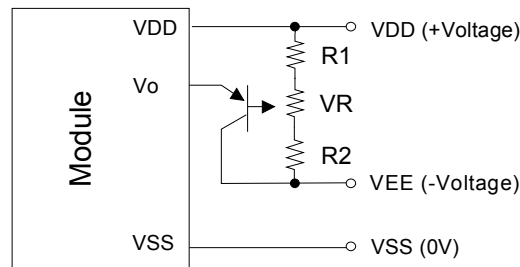

$$R1+R2+VR=10 \sim 20K\Omega$$

$$Tr=2SA1202 \text{ or equivalent}$$



Messrs. Standard					
Product Specification	Model	NMTC-S40200XFYHSAY-10A	Rev. No.	Issued Date.	Page.
			A.	Sept. 11, 17	14 / 22

4.3 Block Diagram

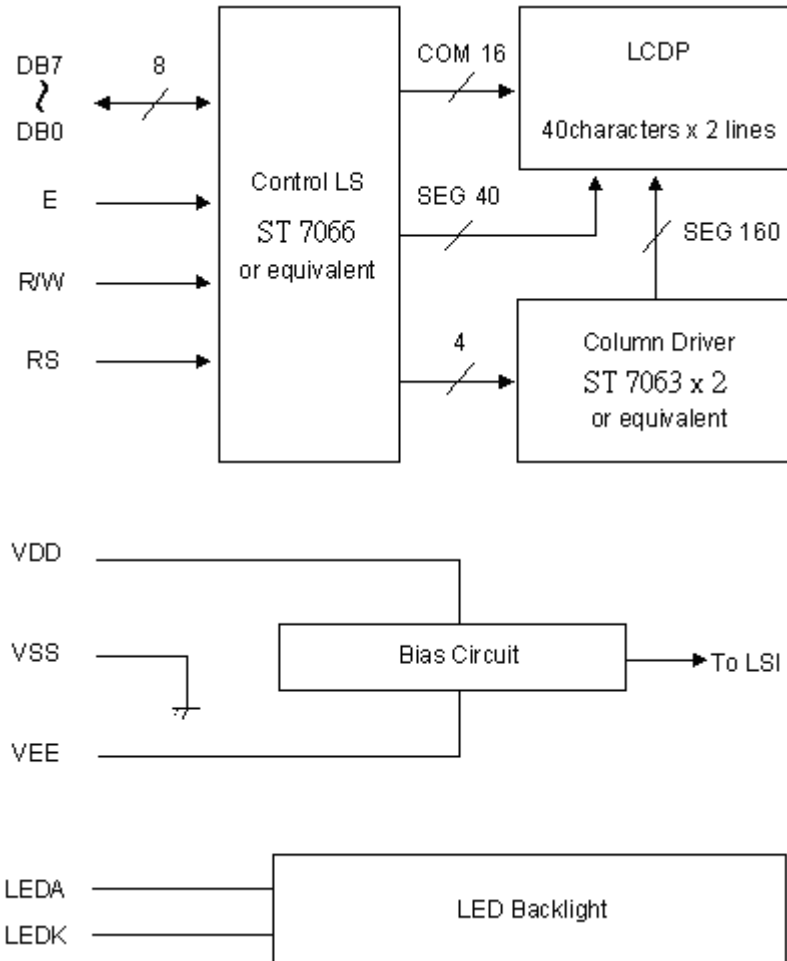

Messrs. Standard					
Product Specification	Model	NMTC-S40200XFYHSAY-10A	Rev. No.	Issued Date.	Page.
			A.	Sept. 11, 17	15 / 22

5. Reliability Test

5.1 Test Item

No change on display and in operation under the following test condition.

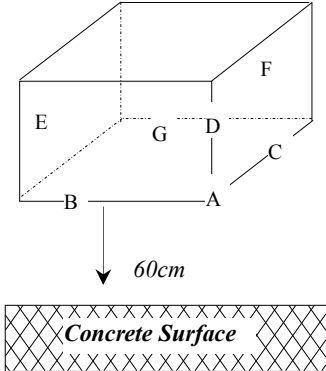
No.	Test Item	Description	Condition	Note
1.	High Temperature (Operation)	Durability test under long time high temperature with electrical stress (voltage, current)	70°C ± 2°C, 240hrs	--
2.	High Temperature (Storage)	Durability test under long time high temperature storage	80°C ± 2°C, 240hrs	4
3.	Low Temperature (Operation)	Durability test under long time low temperature with electrical stress (voltage, current)	-30°C ± 2°C, 240hrs	3
4.	Low Temperature (Storage)	Durability test under long time low temperature storage	-20°C ± 2°C, 240hrs	3, 4
5.	Damp Proof Test	Durability test under long time high temperature and high humidity	60°C ± 2°C, 95% RH 240hrs	3, 4
6.	Vibration Test	Total fixed amplitude: 1.5mm Vibration frequency: 10~55Hz One cycle 60 seconds to 3 directions of X, Y, Z for each 15 minutes	--	5
7.	Drop Test	To be measured after dropping from 60cm high on the concrete surface in packing state.  <i>Dropping method corner dropping</i> <i>A corner: once</i> <i>Edge dropping</i> <i>B, C, D edge: once</i> <i>Face dropping</i> <i>E, F, G face: once</i>	--	--

Note 1: Unless otherwise specified, tests will be conducted under the following condition,

Temperature : 25°C ± 2°C

Humidity : 65% ± 5%

Note 2: Unless otherwise specified, tests will be not conducted under functioning state.

Note 3: No dew condensation to be observed.

Note 4: The function test shall be conducted after 4 hours storage at the normal temperature and humidity after removed from the test chamber.

Note 5: Vibration test will be conducted to the product itself without putting it in a container.



Microtips Technology Inc.

Messrs. Standard					
Product Specification	Model	NMTC-S40200XFYHSAY-10A	Rev. No.	Issued Date.	Page.
			A.	Sept. 11, 17	16 / 22

5.2 Judgment Standard

Failure Mode	Test Item							Judgment Standard
	1	2	3	4	5	6	7	
Orientation	*	*	*	*	*			No remarkable degradation of appearance under bias / non – bias condition
Current Value (IAC)	*	*	*	*	*			No remarkable increase
Contrast	*		*	*	*			No remarkable poor contrast
Domain	*	*	*	*	*			Less than 20% of all dots have reverse tilt of more than on third of one dot area.
Bubble (Inside Cell)	*	*	*	*	*	*		As per “Appearance Standard” (Note. In – cluding one which disappear after 25°C 2H)
Polarizer	*				*	*		As per “Appearance Standard” no remarkable appearance change
Glass Damage							*	As per “Appearance Standard”

Note. 1. * is strong linkage between Failure Mode and Test Item.

2. Number of Test Item should be referred to former page.

3. Judgment and Standard value should be fixed by other inspection standard and criteria samples.



Microtips Technology Inc.

Messrs. Standard					
Product Specification	Model	NMTC-S40200XFYHSAY-10A	Rev. No.	Issued Date.	Page.
			A.	Sept. 11, 17	17 / 22

6. Appearance Standards

6.1 Inspection Conditions

The LCD shall be inspected under 40W white fluorescent light. The distance between the eyes and the sample shall be more than 30cm. All directions for inspecting the sample should be within 45° against perpendicular line.

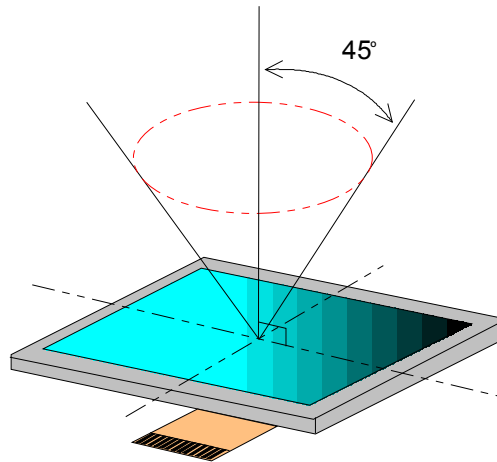

6.2 Definition of Applicable Zones

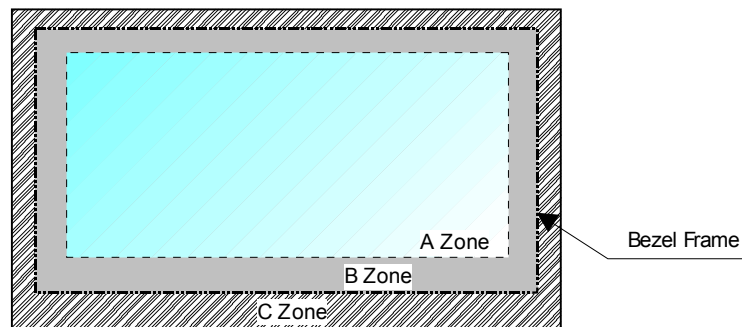

A Zone: Active display area

B Zone: Area from outside of "A Zone" to validity viewing area

C Zone: Rest parts

A Zone + B Zone = Validity viewing area



Microtips Technology Inc.

Messrs. Standard					
Product Specification	Model	NMTC-S40200XFYHSAY-10A	Rev. No.	Issued Date.	Page.
			A.	Sept. 11, 17	18 / 22

6.3 Standards

No.	Parameter	Criteria																																																							
1.	Black and White Spots, Foreign Substances	<p>(1) Round Shape</p> <table border="1"> <thead> <tr> <th rowspan="2">Zone Dimension (mm)</th> <th colspan="3">Acceptable Number</th> </tr> <tr> <th>A</th> <th>B</th> <th>C</th> </tr> </thead> <tbody> <tr> <td>D ≤ 0.1</td> <td>*</td> <td>*</td> <td>*</td> </tr> <tr> <td>0.1 < D ≤ 0.2</td> <td>3</td> <td>5</td> <td>*</td> </tr> <tr> <td>0.2 < D ≤ 0.25</td> <td>2</td> <td>3</td> <td>*</td> </tr> <tr> <td>0.25 < D ≤ 0.3</td> <td>0</td> <td>1</td> <td>*</td> </tr> <tr> <td>0.3 < D</td> <td>0</td> <td>0</td> <td>*</td> </tr> </tbody> </table> <p>D = (Long + Short) / 2 *: Disregard</p> <p>(2) Line Shape</p> <table border="1"> <thead> <tr> <th rowspan="2">Zone X (mm)</th> <th rowspan="2">Zone Y (mm)</th> <th colspan="3">Acceptable Number</th> </tr> <tr> <th>A</th> <th>B</th> <th>C</th> </tr> </thead> <tbody> <tr> <td>--</td> <td>0.03 ≥ W</td> <td>*</td> <td>*</td> <td>*</td> </tr> <tr> <td>2.0 ≥ L</td> <td>0.05 ≥ W</td> <td>3</td> <td>3</td> <td>*</td> </tr> <tr> <td>1.0 ≥ L</td> <td>0.1 ≥ W</td> <td>3</td> <td>3</td> <td>*</td> </tr> <tr> <td>--</td> <td>0.1 < W</td> <td colspan="3">In the same way (1)</td> </tr> </tbody> </table> <p>X: Length Y: Width *: Disregard</p> <p>Total defects shall not exceed 5.</p>	Zone Dimension (mm)	Acceptable Number			A	B	C	D ≤ 0.1	*	*	*	0.1 < D ≤ 0.2	3	5	*	0.2 < D ≤ 0.25	2	3	*	0.25 < D ≤ 0.3	0	1	*	0.3 < D	0	0	*	Zone X (mm)	Zone Y (mm)	Acceptable Number			A	B	C	--	0.03 ≥ W	*	*	*	2.0 ≥ L	0.05 ≥ W	3	3	*	1.0 ≥ L	0.1 ≥ W	3	3	*	--	0.1 < W	In the same way (1)		
Zone Dimension (mm)	Acceptable Number																																																								
	A	B	C																																																						
D ≤ 0.1	*	*	*																																																						
0.1 < D ≤ 0.2	3	5	*																																																						
0.2 < D ≤ 0.25	2	3	*																																																						
0.25 < D ≤ 0.3	0	1	*																																																						
0.3 < D	0	0	*																																																						
Zone X (mm)	Zone Y (mm)	Acceptable Number																																																							
		A	B	C																																																					
--	0.03 ≥ W	*	*	*																																																					
2.0 ≥ L	0.05 ≥ W	3	3	*																																																					
1.0 ≥ L	0.1 ≥ W	3	3	*																																																					
--	0.1 < W	In the same way (1)																																																							
2.	Air Bubbles (between glass & polarizer)	<table border="1"> <thead> <tr> <th rowspan="2">Zone Dimension (mm)</th> <th colspan="3">Acceptable Number</th> </tr> <tr> <th>A</th> <th>B</th> <th>C</th> </tr> </thead> <tbody> <tr> <td>D ≤ 0.3</td> <td>*</td> <td>*</td> <td>*</td> </tr> <tr> <td>0.3 < D ≤ 0.4</td> <td>3</td> <td>*</td> <td>*</td> </tr> <tr> <td>0.4 < D ≤ 0.6</td> <td>2</td> <td>3</td> <td>*</td> </tr> <tr> <td>0.6 < D</td> <td>0</td> <td>0</td> <td>*</td> </tr> </tbody> </table> <p>*: Disregard</p> <p>Total defects shall not exceed 3.</p>	Zone Dimension (mm)	Acceptable Number			A	B	C	D ≤ 0.3	*	*	*	0.3 < D ≤ 0.4	3	*	*	0.4 < D ≤ 0.6	2	3	*	0.6 < D	0	0	*																																
Zone Dimension (mm)	Acceptable Number																																																								
	A	B	C																																																						
D ≤ 0.3	*	*	*																																																						
0.3 < D ≤ 0.4	3	*	*																																																						
0.4 < D ≤ 0.6	2	3	*																																																						
0.6 < D	0	0	*																																																						

To be continued.....

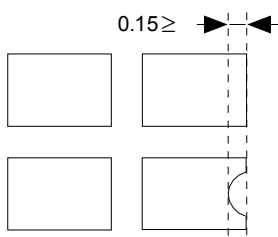
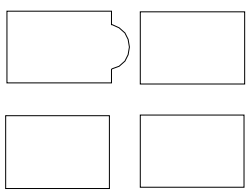
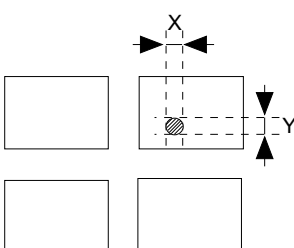
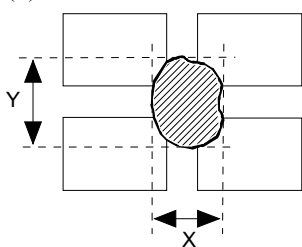

Messrs. Standard					
Product Specification	Model	NMTC-S40200XFYHSAY-10A	Rev. No.	Issued Date.	Page.
			A.	Sept. 11, 17	19 / 22

No.	Parameter	Criteria
3.	The Shape of Dot	<p>(1) Dot Shape (with Dent)</p>  <p>0.15 ≥</p> <p>As per the sketch of left hand.</p> <p>(2) Dot Shape (with Projection)</p>  <p>Should not be connected to next dot.</p> <p>(3) Pin Hole</p>  <p>$(X + Y) / 2 \leq 0.2\text{mm}$ (Less than 0.1mm is no counted.)</p> <p>(4) Deformation</p>  <p>$(X + Y) / 2 \leq 0.2\text{mm}$</p> <p>Total acceptable number: 1/dot, 5/cell (Defect number of (4): 1pc.)</p>
4.	Polarizer Scratches	Not to be conspicuous defects.
5.	Polarizer Dirt's	If the stains are removed easily from LCDP surface, the module is not defective.
6.	Complex Foreign Substance Defects	Black spots, line shaped foreign substance or air bubbles between glass & polarizer should be 5pcs maximum in total.
7.	Distance between different Foreign Substance defects	$D \leq 0.2$: 20mm or more $0.2 < D$: 40mm or more



Messrs. Standard					
Product Specification	Model	NMTC-S40200XFYHSAY-10A	Rev. No.	Issued Date.	Page.
			A.	Sept. 11, 17	20 / 22

7. Handling and Precautions

The Following precautions will guide you in handling our product correctly.

- 1 Liquid crystal display devices
 - 1.1 The liquid crystal display device panel used in the liquid crystal display module is made of plate glass. Avoid any strong mechanical shock. Should the glass break handle it with care.
 - 1.2 The polarizer adhering to the surface of the LCD is made of a soft material. Guard against scratching it.
- 2 Care of the liquid crystal display module against static electricity discharge.
 - 2.1 When working with the module, be sure to ground your body and any electrical equipment you may be using. We strongly recommend the use of anti static mats (made of rubber), to protect work tables against the hazards of electrical shock.
 - 2.2 Avoid the use of work clothing made of synthetic fibers. We recommend cotton clothing or other conductivity-treated fibers.
 - 2.3 Slowly and carefully remove the protective film from the LCD module, since this operation can generate static electricity.
- 3 When the LCD module alone must be stored for long periods of time:
 - 3.1 Protect the modules from high temperature and humidity.
 - 3.2 Keep the modules out of direct sunlight or direct exposure to ultra-violet rays.
 - 3.3 Protect the modules from excessive external forces.
- 4 Use the module with a power supply that is equipped with an over current protector circuit, since the module is not provided with this protective feature.
- 5 Do not ingest the LCD fluid itself should it leak out of a damaged LCD module. Should hands or clothing come in contact with LCD fluid, wash immediately with soap.
- 6 Conductivity is not guaranteed for models that use metal holders where solder connections between the metal holder and the PCB are not used. Please contact us to discuss appropriate ways to assure conductivity.



Microtips Technology Inc.

Messrs. Standard					
Product Specification	Model	NMTC-S40200XFYHSAY-10A	Rev. No.	Issued Date.	Page.
			A.	Sept. 11, 17	21 / 22

8. Warranty

This product has been manufactured to your company's specifications as a part for use in your company's general electronic products. It is guaranteed to perform according to delivery specifications. For any other use apart from general electronic equipment, we cannot take responsibility if the product is used in medical devices, nuclear power control equipment, aerospace equipment, fire and security systems, or any other applications in which there is a direct risk to human life and where extremely high levels of reliability are required. If the product is to be used in any of the above applications, we will need to enter into a separate product liability agreement.

- 1 13 months guarantee starts from the date code.
- 2 We cannot accept responsibility for any defect, which may arise from additional manufacturing of the product (including disassembly and reassembly), after product delivery.
- 3 We cannot accept responsibility for any defect, which may arise after the application of strong external force to the product.
- 4 We cannot accept responsibility for any defect, which may arise due to the application of static electricity after the product has passed your company's acceptance inspection procedures.
- 5 We cannot accept responsibility for industrial property, which may arise through the use of your product, with exception to those issues relating directly to the structure or method of manufacturing of our product. Microtips-origin longer than one year from Microtips production.

9. Dimensional Outlines

- See the next page.....



Microtips Technology Inc.

REV.	DESCRIPTION	DRAWN	CHECK	APP'D	DATE
A	Production Release	James Lu			01/14/04
B	Modify Dimension & Show LED Position	Carol			05/19/04

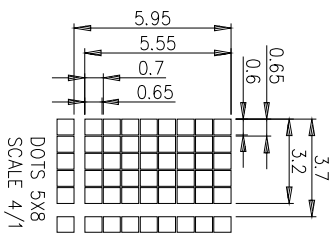
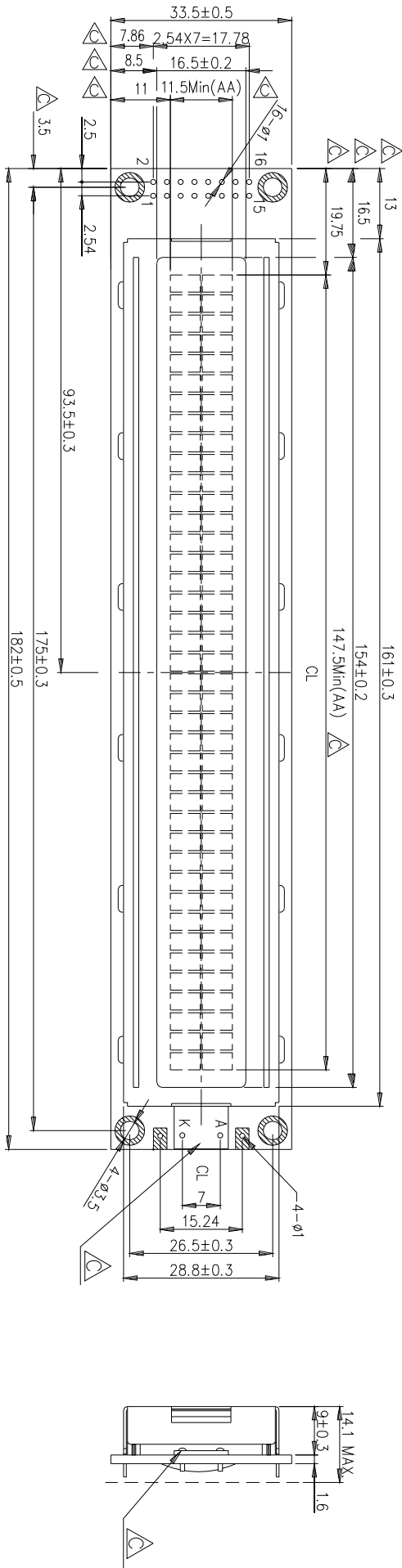

PIN ASSIGNMENT

1.	Vss	5.	R/W	9.	DB2	13.	DB6
2.	Vdd	6.	E	10.	DB3	14.	DB7
3.	Ve	7.	DB0	11.	DB4	15.	LED A
4.	RS	8.	DB1	12.	DB5	16.	LED K

NO.	M-40200XH	Q'TY	05/19/04	MATERIAL	FINISH
PART NAME		DATE:			
DRAWN	Carol	APP'D		SCALE: 1 / 1	PRODUCT: MTC-40200XH
CHECK	MT RD 05/19/04	UNIT: MM		JUNLESS OTHERWISE SPECIFIED TOLERANCE ON FRACTIONS DECIMALS ANGLES 0.10 0.5°	DWG NO.: C40200X1
					FILE: DWG\Design\LOM\MTC\MTC-40200X\2D
					SHEET 1 / 1 Rev: C

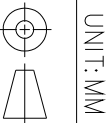
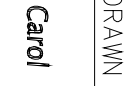

Компания «Океан Электроники» предлагает заключение долгосрочных отношений при поставках импортных электронных компонентов на взаимовыгодных условиях!

Наши преимущества:

- Поставка оригинальных импортных электронных компонентов напрямую с производств Америки, Европы и Азии, а так же с крупнейших складов мира;
- Широкая линейка поставок активных и пассивных импортных электронных компонентов (более 30 млн. наименований);
- Поставка сложных, дефицитных, либо снятых с производства позиций;
- Оперативные сроки поставки под заказ (от 5 рабочих дней);
- Экспресс доставка в любую точку России;
- Помощь Конструкторского Отдела и консультации квалифицированных инженеров;
- Техническая поддержка проекта, помощь в подборе аналогов, поставка прототипов;
- Поставка электронных компонентов под контролем ВП;
- Система менеджмента качества сертифицирована по Международному стандарту ISO 9001;
- При необходимости вся продукция военного и аэрокосмического назначения проходит испытания и сертификацию в лаборатории (по согласованию с заказчиком);
- Поставка специализированных компонентов военного и аэрокосмического уровня качества (Xilinx, Altera, Analog Devices, Intersil, Interpoint, Microsemi, Actel, Aeroflex, Peregrine, VPT, Syfer, Eurofarad, Texas Instruments, MS Kennedy, Miteq, Cobham, E2V, MA-COM, Hittite, Mini-Circuits, General Dynamics и др.);

Компания «Океан Электроники» является официальным дистрибьютором и эксклюзивным представителем в России одного из крупнейших производителей разъемов военного и аэрокосмического назначения «JONHON», а так же официальным дистрибьютором и эксклюзивным представителем в России производителя высокотехнологичных и надежных решений для передачи СВЧ сигналов «FORSTAR».



JONHON

«JONHON» (основан в 1970 г.)

Разъемы специального, военного и аэрокосмического назначения:

(Применяются в военной, авиационной, аэрокосмической, морской, железнодорожной, горно- и нефтедобывающей отраслях промышленности)

«FORSTAR» (основан в 1998 г.)

ВЧ соединители, коаксиальные кабели,
кабельные сборки и микроволновые компоненты:

(Применяются в телекоммуникациях гражданского и специального назначения, в средствах связи, РЛС, а так же военной, авиационной и аэрокосмической отраслях промышленности).



Телефон: 8 (812) 309-75-97 (многоканальный)

Факс: 8 (812) 320-03-32

Электронная почта: ocean@oceanchips.ru

Web: <http://oceanchips.ru/>

Адрес: 198099, г. Санкт-Петербург, ул. Калинина, д. 2, корп. 4, лит. А