

# Thin-Film Directional Couplers



## CP0805 SMD Type

### GENERAL DESCRIPTION ITF (Integrated Thin-Film) TECHNOLOGY

The ITF SMD Coupler is based on thin-film multilayer technology. The technology provides a miniature part with excellent high frequency performance and rugged construction for reliable automatic assembly.

The ITF Coupler is offered in a variety of frequency bands compatible with various types of high frequency wireless systems.

### FEATURES

- Small Size: 0805
- Frequency Range: 800MHz - 3GHz
- Characteristic Impedance: 50Ω
- Operating / Storage Temp.: -40°C to +85°C
- Power Rating: 3W Continuous
- Low Profile
- Rugged Construction
- Taped and Reeled

### APPLICATIONS

- Mobile Communications
- Satellite TV Receivers
- GPS
- Vehicle Location Systems
- Wireless LAN's

### DIMENSIONS: (Top View) millimeters (inches)



	0805
L	2.03±0.1 (0.080±0.004)
W	1.55±0.1 (0.061±0.004)
T	0.98±0.1 (0.039±0.004)
A	0.56±0.25 (0.022±0.010)
B	0.35±0.15 (0.014±0.006)

### HOW TO ORDER

<b>CP</b> T	<b>0805</b> T	<b>A</b> T	<b>0902</b> T	<b>A</b> T	<b>S</b> T	<b>TR</b> T
<b>Style</b> Directional Coupler	<b>Size</b> 0805	<b>Layout Type</b> (see layout types)	<b>Frequency</b> MHz	<b>Sub Type</b> (see layout sub-types)	<b>Termination Code</b> W = Nickel/Solder (Sn/Pb) **S = Nickel / Lead Free Solder (Sn100)	<b>Packaging Code</b> TR = Tape and Reel

Not RoHS Compliant

LEAD-FREE  
LEAD-FREE COMPATIBLE  
COMPONENT

RoHS  
COMPLIANT

For RoHS compliant products, please select correct termination style.

\*\*RoHS compliant

### QUALITY INSPECTION

Finished parts are 100% tested for electrical parameters and visual characteristics. Each production lot is evaluated on a sample basis for:

- Static Humidity: 85°C, 85% RH, 160 hours
- Endurance: 125°C, I<sub>R</sub>, 4 hours

### TERMINATION

Nickel/Solder coating (Sn, Pb) compatible with automatic soldering technologies: reflow, wave soldering, vapor phase and manual.

### Recommended Pad Layout Dimensions mm (inches)



NOTE: Components must be mounted on the board with the white (Alumina) side DOWN.

# Thin-Film Directional Couplers



## CP0805 Layout Types

### LAYOUT



### Sn100 LAYOUT

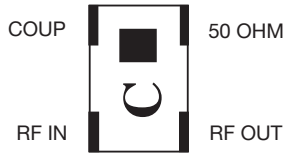

Type: A  
Sub-Type: A



### LAYOUT



### Sn100 LAYOUT

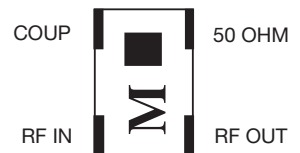

Type: A  
Sub-Type: B

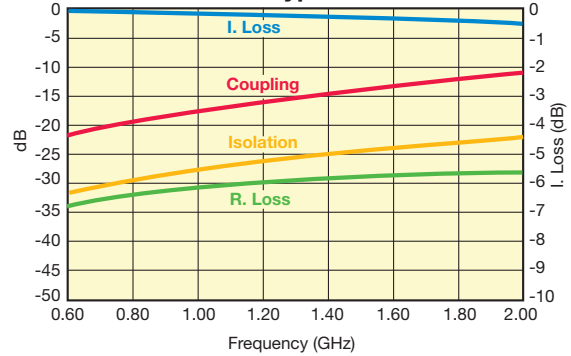

Application	P/N Examples	Frequency Band [MHz]	Coupling [dB]	I. Loss max	VSWR max
AMPS	CP0805A0836AW	824 - 849	16.5±1	0.25	1.2
	CP0805A0881AW	869 - 894	16±1		
GSM	CP0805A0902AW	890 - 915	16±1		
	CP0805A0947AW	935 - 960	15.5±1		
E-GSM	CP0805A0897AW	880 - 915	16±1		
	CP0805A0942AW	925 - 960	15.5±1		
PDC	CP0805A1441AW	1429 - 1453	12±1	0.5	1.3
PCN	CP0805A1747AW	1710 - 1785	10.5±1	0.8	1.4
	CP0805A1842AW	1805 - 1880	10±1		
PCS	CP0805A1880AW	1850 - 1910	9.5±1	0.7	1.4
	CP0805A1960AW	1930 - 1990	9.5±1		
PHP	CP0805A1907AW	1895 - 1920	9.5±1	0.6	
DECT	CP0805A1890AW	1880 - 1900	9.5±1	0.6	

Application	P/N Examples	Frequency Band [MHz]	Coupling [dB]	I. Loss max	VSWR max
AMPS	CP0805A0836BW	824 - 849	19±1	0.25	1.2
	CP0805A0881BW	869 - 894	18.5±1		
GSM	CP0805A0902BW	890 - 915	18±1		
	CP0805A0947BW	935 - 960	18±1		
E-GSM	CP0805A0897BW	880 - 915	18.5±1		
	CP0805A0942BW	925 - 960	18±1		
PDC	CP0805A1441BW	1429 - 1453	14.5±1	0.35	
PCN	CP0805A1747BW	1710 - 1785	12.5±1	0.5	1.4
	CP0805A1842BW	1805 - 1880	12.5±1		
PCS	CP0805A1880BW	1850 - 1910	12±1	0.6	1.4
	CP0805A1960BW	1930 - 1990	11.5±1		
PHP	CP0805A1907BW	1895 - 1920	12±1	0.6	
DECT	CP0805A1890BW	1880 - 1900	12±1	0.6	
Wireless LAN	CP0805A2442BW	2400 - 2484	10±1	0.9	

### LAYOUT

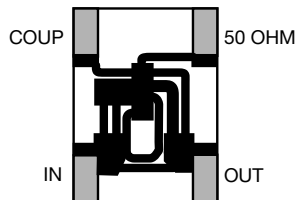

### Sn100 LAYOUT

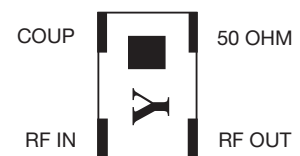

Type: A  
Sub-Type: C



Application	P/N Examples	Frequency Band [MHz]	Coupling [dB]	I. Loss max	VSWR max
AMPS	CP0805A0836CW	824 - 849	14±1	0.5	1.4
	CP0805A0881CW	869 - 894	13.5±1		
GSM	CP0805A0902CW	890 - 915	13.5±1		
	CP0805A0947CW	935 - 960	13±1		
E-GSM	CP0805A0897CW	880 - 915	13.5±1		
	CP0805A0942CW	925 - 960	13±1		
PDC	CP0805A1441CW	1429 - 1453	9.5±1	1.15	1.8
PCN	CP0805A1747CW	1710 - 1785	8±1	1.6	2.2
	CP0805A1842CW	1805 - 1880	8±1		
PCS	CP0805A1880CW	1850 - 1910	7.5±1	1.75	2.2
	CP0805A1960CW	1930 - 1990	7.5±1		
PHP	CP0805A1907CW	1895 - 1920	7.5±1	2.5	
DECT	CP0805A1890CW	1880 - 1900	7.5±1	2.5	
Wireless LAN	CP0805A2442CW	2400 - 2484	6±1	2.5	

Important: Couplers can be used at any frequency within the indicated range.



# Thin-Film Directional Couplers



## CP0805 Layout Types

### LAYOUT



### Sn100 LAYOUT



Type: A  
Sub-Type: D



### LAYOUT



### Sn100 LAYOUT



Type: A  
Sub-Type: E



3

Application	P/N Examples	Frequency Band [MHz]	Coupling [dB]	I. Loss max	VSWR max
AMPS	CP0805A0836DW	824 - 849	13.0±1	0.5	1.4
	CP0805A0881DW	869 - 894	12.5±1		
GSM	CP0805A0902DW	890 - 915	12.5±1	1.85	1.8
	CP0805A0947DW	935 - 960	12±1		
E-GSM	CP0805A0897DW	880 - 915	12.5±1	2.15	2.1
	CP0805A0942DW	925 - 960	12±1		
PDC	CP0805A1441DW	1429 - 1453	8.5±1	1.25	1.8
PCN	CP0805A1747DW	1710 - 1785	7±1	1.85	2.2
	CP0805A1842DW	1805 - 1880	7±1		
PCS	CP0805A1880DW	1850 - 1910	7±1	2.4	2.4
	CP0805A1960DW	1930 - 1990	6.5±1		
PHP	CP0805A1907DW	1895 - 1920	6.5±1	1.85	1.8
DECT	CP0805A1890DW	1880 - 1900	7±1	2.4	2.1
Wireless LAN	CP0805A2442DW	2400 - 2484	5.5±1	2.4	2.1

Application	P/N Examples	Frequency Band [MHz]	Coupling [dB]	I. Loss max	VSWR max
AMPS	CP0805A0836EW	824 - 849	11±1	0.85	1.4
	CP0805A0881EW	869 - 894	10.5±1		
GSM	CP0805A0902EW	890 - 915	10.5±1	1.8	1.8
	CP0805A0947EW	935 - 960	10±1		
E-GSM	CP0805A0897EW	880 - 915	10.5±1	2.7	2.2
	CP0805A0942EW	925 - 960	10±1		
PDC	CP0805A1441EW	1429 - 1453	7±1	1.8	1.8
PCN	CP0805A1747EW	1710 - 1785	5.5±1	3.15	2.4
	CP0805A1842EW	1805 - 1880	5.5±1		
PCS	CP0805A1880EW	1850 - 1910	5±1	4.2	2.4
	CP0805A1960EW	1930 - 1990	5±1		
PHP	CP0805A1907EW	1895 - 1920	5±1	2.7	2.2
DECT	CP0805A1890EW	1880 - 1900	5±1	4.2	2.4
Wireless LAN	CP0805A2442EW	2400 - 2484	4±1	4.2	2.4

Type: B  
Sub-Type: A



### LAYOUT

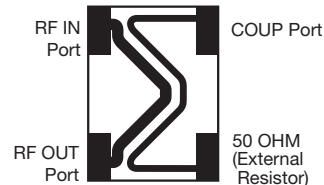

### Sn100 LAYOUT

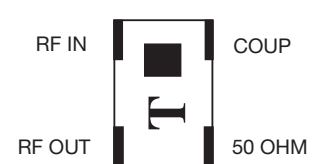

Application	P/N Examples	Frequency Band [MHz]	Coupling [dB]	I. Loss max	VSWR max
AMPS	CP0805B0836AW	824 - 849	21.5±1	0.25	1.2
	CP0805B0881AW	869 - 894	21±1		
GSM	CP0805B0902AW	890 - 915	21±1	0.3	1.2
	CP0805B0947AW	935 - 960	20.5±1		
E-GSM	CP0805B0897AW	880 - 915	21±1	0.4	1.2
	CP0805B0942AW	925 - 960	20.5±1		
PDC	CP0805B1441AW	1429 - 1453	17±1	0.3	1.2
PCN	CP0805B1747AW	1710 - 1785	15.5±1	0.4	1.2
	CP0805B1842AW	1805 - 1880	15.5±1		
PCS	CP0805B1880AW	1850 - 1910	15±1	0.3	1.2
	CP0805B1960AW	1930 - 1990	14.5±1		
PHP	CP0805B1907AW	1895 - 1920	15±1	0.3	1.2
DECT	CP0805B1890AW	1880 - 1900	15±1	0.4	1.2
Wireless LAN	CP0805B2442AW	2400 - 2484	13±1	0.4	1.2

Important: Couplers can be used at any frequency within the indicated range.



# Thin-Film Directional Couplers



## CP0805 Layout Types



Type: B  
Sub-Type: B



Type: B  
Sub-Type: C



Application	P/N Examples	Frequency Band [MHz]	Coupling [dB]	I. Loss max	VSWR max
AMPS	CP0805B0836BW	824 - 849	23.5±1	0.25	1.2
	CP0805B0881BW	869 - 894	23±1		
GSM	CP0805B0902BW	890 - 915	22.5±1		
	CP0805B0947BW	935 - 960	22±1		
E-GSM	CP0805B0897BW	880 - 915	23±1		
	CP0805B0942BW	925 - 960	22±1		
PDC	CP0805B1441BW	1429 - 1453	18.5±1		
PCN	CP0805B1747BW	1710 - 1785	17±1		
	CP0805B1842BW	1805 - 1880	16.5±1		
PCS	CP0805B1880BW	1850 - 1910	16.5±1		
	CP0805B1960BW	1930 - 1990	16±1		
PHP	CP0805B1907BW	1895 - 1920	16±1		
DECT	CP0805B1890BW	1880 - 1900	16±1		
Wireless LAN	CP0805B2442BW	2400 - 2484	14±1	0.4	

Application	P/N Examples	Frequency Band [MHz]	Coupling [dB]	I. Loss max	VSWR max
AMPS	CP0805B0836CW	824 - 849	25±1	0.25	1.2
	CP0805B0881CW	869 - 894	24.5±1		
GSM	CP0805B0902CW	890 - 915	24±1		
	CP0805B0947CW	935 - 960	24±1		
E-GSM	CP0805B0897CW	880 - 915	24.5±1		
	CP0805B0942CW	925 - 960	24±1		
PDC	CP0805B1441CW	1429 - 1453	20±1		
PCN	CP0805B1747CW	1710 - 1785	18.5±1		
	CP0805B1842CW	1805 - 1880	18.5±1		
PCS	CP0805B1880CW	1850 - 1910	18±1		
	CP0805B1960CW	1930 - 1990	17.5±1		
PHP	CP0805B1907CW	1895 - 1920	18±1		
DECT	CP0805B1890CW	1880 - 1900	18±1		
Wireless LAN	CP0805B2442CW	2400 - 2484	16±1	0.4	

Important: Couplers can be used at any frequency within the indicated range.



# Thin-Film Directional Couplers



## CP0805 Layout Types

### VHF DIRECTIONAL COUPLER

CP0805L0155ASTR

Sn100 LAYOUT



P/N	Frequency [MHz]	Coupling [dB]	R. Loss [dB]	I. Loss max [dB]	Directivity [dB]
CP0805L0155ASTR	155	17.1±1	24	0.35	22



### UHF DIRECTIONAL COUPLER

CP0805L0436BSTR

Sn100 LAYOUT



P/N	Frequency [MHz]	Coupling [dB]	R. Loss [dB]	I. Loss max [dB]	Directivity [dB]
CP0805L0436BSTR	403-470	15.85±1	35	0.25	22

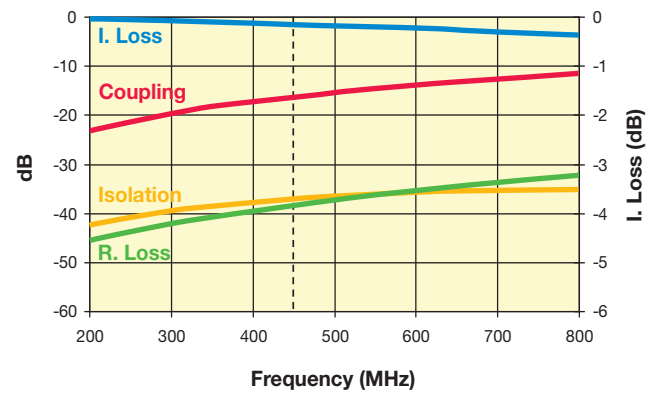

Important: Couplers can be used at any frequency within the indicated range.

# Thin-Film Directional Couplers



## CP0805 and CP0603 Test Jig

### ITF TEST JIG FOR COUPLER TYPES 0805 AND 0603 SMD

#### GENERAL DESCRIPTION

This jig is designed for the testing of CP0805 and CP0603 series Directional Couplers using a vector network analyzer. It consists of a FR4 multi-layer substrate, having 50Ω microstrips as conducting lines and a ground plane in the middle layer, located at a distance of 0.2mm from the microstrips.

The connectors are SMA type (female), 'Johnson Components Inc.' Product P/N: 142-0701-881.

The jig is designed for a full 2-port calibration. LOAD calibration can be done either by a 50Ω SMA termination, or by soldering a 50Ω chip resistor at the 50Ω ports.

#### MEASUREMENT PROCEDURE

When measuring a component, it can be either soldered or pressed by a non-metallic stick until all four ports touch the appropriate pads. To measure the coupling (and the R. Loss) place the component on the Port 1 & Port 2 pads. Use two SMA 50Ω terminations (male) to terminate the ports, which are not connected to the network analyzer, and connect the network analyzer to the two ports. A 90° rotation of the component on its pads allows measuring a second parameter (I. Loss).



### CP0805 SERIES DIRECTIONAL COUPLERS

#### Orientation and Tape and Reel Packaging Specification

(Top View)



The parts should be mounted on the PCB with White (Alumina) side down and the "dark" side up.

#### CP0805xxxxxxSTR (Sn100)

(Top View)

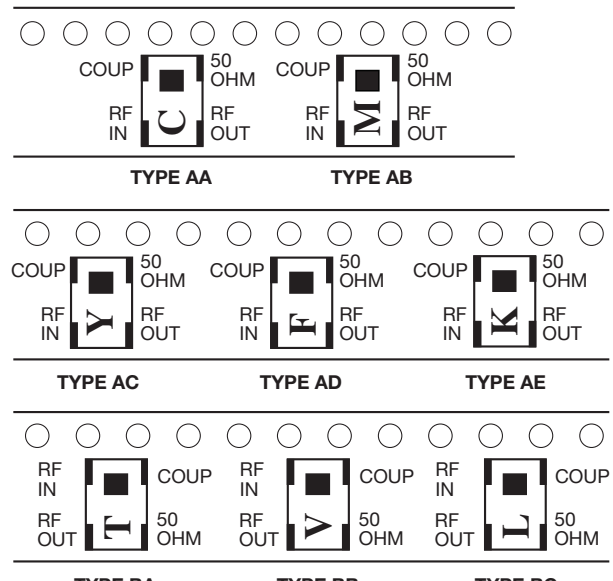

The parts should be mounted on the PCB with printed side up.

3

Компания «Океан Электроники» предлагает заключение долгосрочных отношений при поставках импортных электронных компонентов на взаимовыгодных условиях!

Наши преимущества:

- Поставка оригинальных импортных электронных компонентов напрямую с производств Америки, Европы и Азии, а так же с крупнейших складов мира;
- Широкая линейка поставок активных и пассивных импортных электронных компонентов (более 30 млн. наименований);
- Поставка сложных, дефицитных, либо снятых с производства позиций;
- Оперативные сроки поставки под заказ (от 5 рабочих дней);
- Экспресс доставка в любую точку России;
- Помощь Конструкторского Отдела и консультации квалифицированных инженеров;
- Техническая поддержка проекта, помощь в подборе аналогов, поставка прототипов;
- Поставка электронных компонентов под контролем ВП;
- Система менеджмента качества сертифицирована по Международному стандарту ISO 9001;
- При необходимости вся продукция военного и аэрокосмического назначения проходит испытания и сертификацию в лаборатории (по согласованию с заказчиком);
- Поставка специализированных компонентов военного и аэрокосмического уровня качества (Xilinx, Altera, Analog Devices, Intersil, Interpoint, Microsemi, Actel, Aeroflex, Peregrine, VPT, Syfer, Eurofarad, Texas Instruments, MS Kennedy, Miteq, Cobham, E2V, MA-COM, Hittite, Mini-Circuits, General Dynamics и др.);

Компания «Океан Электроники» является официальным дистрибьютором и эксклюзивным представителем в России одного из крупнейших производителей разъемов военного и аэрокосмического назначения «JONHON», а так же официальным дистрибьютором и эксклюзивным представителем в России производителя высокотехнологичных и надежных решений для передачи СВЧ сигналов «FORSTAR».



## JONHON

«JONHON» (основан в 1970 г.)

Разъемы специального, военного и аэрокосмического назначения:

(Применяются в военной, авиационной, аэрокосмической, морской, железнодорожной, горно- и нефтедобывающей отраслях промышленности)

«FORSTAR» (основан в 1998 г.)

ВЧ соединители, коаксиальные кабели, кабельные сборки и микроволновые компоненты:

(Применяются в телекоммуникациях гражданского и специального назначения, в средствах связи, РЛС, а так же военной, авиационной и аэрокосмической отраслях промышленности).



Телефон: 8 (812) 309-75-97 (многоканальный)

Факс: 8 (812) 320-03-32

Электронная почта: [ocean@oceanchips.ru](mailto:ocean@oceanchips.ru)

Web: <http://oceanchips.ru/>

Адрес: 198099, г. Санкт-Петербург, ул. Калинина, д. 2, корп. 4, лит. А