

# MC12093

## ÷2, ÷4, ÷8 1.1 GHz Low Power Prescaler with Stand-By Mode

### Description

The MC12093 is a single modulus prescaler for low power frequency division of a 1.1 GHz high frequency input signal. MOSAIC V™ technology is utilized to achieve low power dissipation of 6.75 mW at a minimum supply voltage of 2.7 V.

On-chip output termination provides output current to drive a 2.0 pF (typical) high impedance load. If additional drive is required for the prescaler output, an external resistor can be added parallel from the OUT pin to GND to increase the output power. Care must be taken not to exceed the maximum allowable current through the output.

Divide ratio control inputs SW1 and SW2 select the required divide ratio of ÷2, ÷4, or ÷8.

Stand-By mode is featured to reduce current drain to 50 µA typical when the standby pin SB is switched LOW disabling the prescaler.

### Features

- 1.1 GHz Toggle Frequency
- Supply Voltage 2.7 V to 5.5 Vdc
- Low Power 3.0 mA Typical
- Operating Temperature = -40°C to 85°C
- Divide by 2, 4 or 8 Selected by SW1 and SW2 Pins
- On-Chip Termination
- These Devices are Pb-Free, Halogen Free and are RoHS Compliant

Table 1. FUNCTIONAL TABLE

SW	SW2	Divide Ratio
L	L	8
H	L	4
L	H	4
H	H	2

1. SW1 & SW2: H = (V<sub>CC</sub> - 0.5 V) to V<sub>CC</sub>; L = Open.
2. SB: H = 2.0 V to V<sub>CC</sub>, L = GND to 0.8 V.



Figure 1. Function Chart



ON Semiconductor™

[www.onsemi.com](http://www.onsemi.com)



SOIC-8 NB  
D SUFFIX  
CASE 751-07

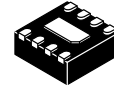

DFN8  
MN SUFFIX  
CASE 506AA

### MARKING DIAGRAM



- A = Assembly Location
- L = Wafer Lot
- Y = Year
- W = Work Week
- = Pb-Free Package

### PIN CONNECTIONS

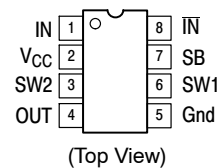

A LOW on the Stand-By Pin 7 disables the device.

### ORDERING INFORMATION

Device	Package	Shipping
MC12093DG	SOIC-8 NB (Pb-Free)	98 Units/Tube
MC12093DR2G	SOIC-8 NB (Pb-Free)	2500 Tape & Reel
MC12093MNR4G	DFN8 (Pb-Free)	1000 Tape & Reel

# MC12093



Figure 2. AC Test Circuit

Table 2. ATTRIBUTES

Characteristics	Value
Internal Input Pulldown Resistor	N/A
Internal Input Pullup Resistor	N/A
ESD Protection Human Body Model Machine Model Charged Device Model	> 4 kV > 200 V > 2 kV
Moisture Sensitivity, Indefinite Time Out of Drypack (Note 1)	Pb-Free Pkg
SOIC-8 NB DFN8	Level 1 Level 1
Flammability Rating Oxygen Index: 28 to 34	UL 94 V-0 @ 0.125 in
Transistor Count	125 Devices
Meets or exceeds JEDEC Spec EIA/JESD78 IC Latchup Test	

1. For additional information, see Application Note [AND8003/D](#).

Table 3. MAXIMUM RATINGS

Symbol	Rating	Value	Unit
V <sub>CC</sub>	Power Supply Voltage, Pin 2	-0.5 to 6.0	Vdc
T <sub>A</sub>	Operating Temperature Range	-40 to 85	°C
T <sub>stg</sub>	Storage Temperature Range	-65 to 150	°C
I <sub>O</sub>	Maximum Output Current, Pin 4	4.0	mA
θ <sub>JC</sub>	Thermal Resistance (Junction-to-Case) (Note 1) DFN8	35 to 40	°C/W

Stresses exceeding those listed in the Maximum Ratings table may damage the device. If any of these limits are exceeded, device functionality should not be assumed, damage may occur and reliability may be affected.

NOTE: ESD data available upon request.

1. JEDEC standard multilayer board – 2S2P (2 signal, 2 power). For DFN8 only, thermal exposed pad must be connected to a sufficient thermal conduit. Electrically connect to the most negative supply (GND) or leave unconnected, floating open.

# MC12093

**Table 4. ELECTRICAL CHARACTERISTICS** ( $V_{CC} = 2.7$  to  $5.5$  V;  $T_A = -40$  to  $85^\circ\text{C}$ )

Symbol	Characteristic	Min	Typ	Max	Unit
ft	Toggle Frequency (Sine Wave)	0.1	1.4	1.1	GHz
I <sub>CC</sub>	Supply Current	–	3.0	4.5	mA
ISB	Stand-By Current	–	120	200	μA
V <sub>IH1</sub>	Stand-By Input HIGH (SB)	2.0	–	V <sub>CC</sub>	V
V <sub>IL1</sub>	Stand-By Input LOW (SB)	Gnd	–	0.8	V
V <sub>IH2</sub>	Divide Ratio Control Input HIGH (SW1 & SW2)	V <sub>CC</sub> – 0.5	V <sub>CC</sub>	V <sub>CC</sub> + 0.5	V
V <sub>IL2</sub>	Divide Ratio Control Input LOW (SW1 & SW2)	OPEN	OPEN	OPEN	
V <sub>OUT</sub>	Output Voltage Swing (2.0 pF Load) Output Frequency 12.5–350 MHz (Note 1) Output Frequency 350–400 MHz (Note 2) Output Frequency 400–450 MHz (Note 3) Output Frequency 450–550 MHz (Note 4)	0.6 0.5 0.4 0.3	0.80 0.70 0.55 0.45	– – – –	V <sub>pp</sub>
V <sub>IN</sub>	Input Voltage Sensitivity 250–1100 MHz 100–250 MHz	100 400	– –	1000 1000	mVpp

1. Input frequency 1.1 GHz, ±8, minimum output frequency of 12.5 MHz.

2. Input frequency 700–800 MHz, ±2.

3. Input frequency 800–900 MHz, ±2.

4. Input frequency 900–1100 MHz, ±2.

# MC12093

## PACKAGE DIMENSIONS

SOIC-8 NB  
D SUFFIX  
CASE 751-07  
ISSUE AK

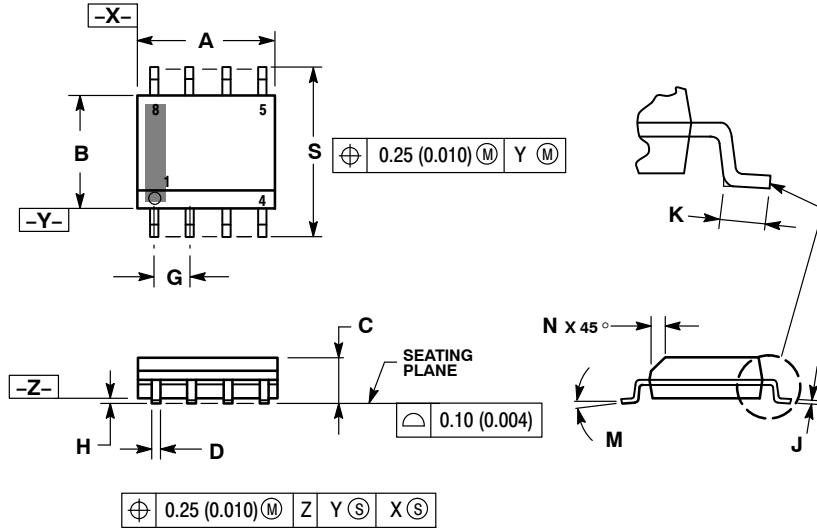

- NOTES:
1. DIMENSIONING AND TOLERANCING PER ANSI Y14.5M, 1982.
  2. CONTROLLING DIMENSION: MILLIMETER.
  3. DIMENSION A AND B DO NOT INCLUDE MOLD PROTRUSION.
  4. MAXIMUM MOLD PROTRUSION 0.15 (0.006) PER SIDE.
  5. DIMENSION D DOES NOT INCLUDE DAMBAR PROTRUSION. ALLOWABLE DAMBAR PROTRUSION SHALL BE 0.127 (0.005) TOTAL IN EXCESS OF THE D DIMENSION AT MAXIMUM MATERIAL CONDITION.
  6. 751-01 THRU 751-06 ARE OBSOLETE. NEW STANDARD IS 751-07.

DIM	MILLIMETERS		INCHES	
	MIN	MAX	MIN	MAX
A	4.80	5.00	0.189	0.197
B	3.80	4.00	0.150	0.157
C	1.35	1.75	0.053	0.069
D	0.33	0.51	0.013	0.020
G	1.27 BSC		0.050 BSC	
H	0.10	0.25	0.004	0.010
J	0.19	0.25	0.007	0.010
K	0.40	1.27	0.016	0.050
M	0°	8°	0°	8°
N	0.25	0.50	0.010	0.020
S	5.80	6.20	0.228	0.244

### SOLDERING FOOTPRINT\*

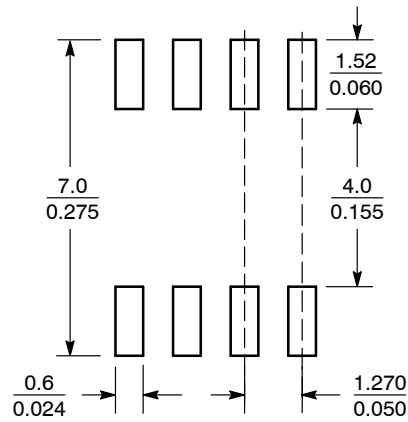

SCALE 6:1  $\left(\frac{\text{mm}}{\text{inches}}\right)$

\*For additional information on our Pb-Free strategy and soldering details, please download the ON Semiconductor Soldering and Mounting Techniques Reference Manual, SOLDERRM/D.

# MC12093

## PACKAGE DIMENSIONS

DFN8 2x2, 0.5 P  
MN SUFFIX  
CASE 506AA  
ISSUE F



NOTE 4

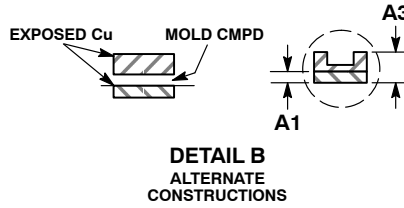
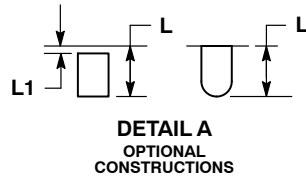

NOTES:

1. DIMENSIONING AND TOLERANCING PER ASME Y14.5M, 1994.
2. CONTROLLING DIMENSION: MILLIMETERS.
3. DIMENSION b APPLIES TO PLATED TERMINAL AND IS MEASURED BETWEEN 0.15 AND 0.20 MM FROM TERMINAL TIP.
4. COPLANARITY APPLIES TO THE EXPOSED PAD AS WELL AS THE TERMINALS.

DIM	MILLIMETERS	
	MIN	MAX
A	0.80	1.00
A1	0.00	0.05
A3	0.20	REF
b	0.20	0.30
D	2.00	BSC
D2	1.10	1.30
E	2.00	BSC
E2	0.70	0.90
e	0.50	BSC
K	0.30	REF
L	0.25	0.35
L1	---	0.10

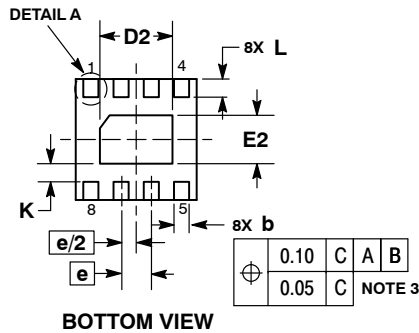

### RECOMMENDED SOLDERING FOOTPRINT\*

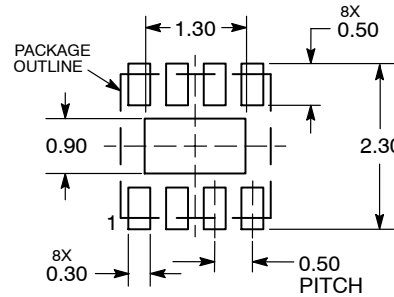

\*For additional information on our Pb-Free strategy and soldering details, please download the ON Semiconductor Soldering and Mounting Techniques Reference Manual, SOLDERRM/D.

MOSAIC V is a trademark of Motorola, Inc., LLC (SCILLC) or its subsidiaries in the United States and/or other countries.

ON Semiconductor and are trademarks of Semiconductor Components Industries, LLC dba ON Semiconductor or its subsidiaries in the United States and/or other countries. ON Semiconductor owns the rights to a number of patents, trademarks, copyrights, trade secrets, and other intellectual property. A listing of ON Semiconductor's product/patent coverage may be accessed at [www.onsemi.com/site/pdf/Patent-Marketing.pdf](http://www.onsemi.com/site/pdf/Patent-Marketing.pdf). ON Semiconductor reserves the right to make changes without further notice to any products herein. ON Semiconductor makes no warranty, representation or guarantee regarding the suitability of its products for any particular purpose, nor does ON Semiconductor assume any liability arising out of the application or use of any product or circuit, and specifically disclaims any and all liability, including without limitation special, consequential or incidental damages. Buyer is responsible for its products and applications using ON Semiconductor products, including compliance with all laws, regulations and safety requirements or standards, regardless of any support or applications information provided by ON Semiconductor. "Typical" parameters which may be provided in ON Semiconductor data sheets and/or specifications can and do vary in different applications and actual performance may vary over time. All operating parameters, including "Typicals" must be validated for each customer application by customer's technical experts. ON Semiconductor does not convey any license under its patent rights nor the rights of others. ON Semiconductor products are not designed, intended, or authorized for use as a critical component in life support systems or any FDA Class 3 medical devices or medical devices with a same or similar classification in a foreign jurisdiction or any devices intended for implantation in the human body. Should Buyer purchase or use ON Semiconductor products for any such unintended or unauthorized application, Buyer shall indemnify and hold ON Semiconductor and its officers, employees, subsidiaries, affiliates, and distributors harmless against all claims, costs, damages, and expenses, and reasonable attorney fees arising out of, directly or indirectly, any claim of personal injury or death associated with such unintended or unauthorized use, even if such claim alleges that ON Semiconductor was negligent regarding the design or manufacture of the part. ON Semiconductor is an Equal Opportunity/Affirmative Action Employer. This literature is subject to all applicable copyright laws and is not for resale in any manner.

### PUBLICATION ORDERING INFORMATION

**LITERATURE FULFILLMENT:**  
Literature Distribution Center for ON Semiconductor  
19521 E. 32nd Pkwy, Aurora, Colorado 80011 USA  
**Phone:** 303-675-2175 or 800-344-3860 Toll Free USA/Canada  
**Fax:** 303-675-2176 or 800-344-3867 Toll Free USA/Canada  
**Email:** [orderlit@onsemi.com](mailto:orderlit@onsemi.com)

**N. American Technical Support:** 800-282-9855 Toll Free  
USA/Canada  
**Europe, Middle East and Africa Technical Support:**  
Phone: 421 33 790 2910  
**Japan Customer Focus Center**  
Phone: 81-3-5817-1050

**ON Semiconductor Website:** [www.onsemi.com](http://www.onsemi.com)  
**Order Literature:** <http://www.onsemi.com/orderlit>

For additional information, please contact your local Sales Representative

Компания «Океан Электроники» предлагает заключение долгосрочных отношений при поставках импортных электронных компонентов на взаимовыгодных условиях!

Наши преимущества:

- Поставка оригинальных импортных электронных компонентов напрямую с производств Америки, Европы и Азии, а так же с крупнейших складов мира;
- Широкая линейка поставок активных и пассивных импортных электронных компонентов (более 30 млн. наименований);
- Поставка сложных, дефицитных, либо снятых с производства позиций;
- Оперативные сроки поставки под заказ (от 5 рабочих дней);
- Экспресс доставка в любую точку России;
- Помощь Конструкторского Отдела и консультации квалифицированных инженеров;
- Техническая поддержка проекта, помощь в подборе аналогов, поставка прототипов;
- Поставка электронных компонентов под контролем ВП;
- Система менеджмента качества сертифицирована по Международному стандарту ISO 9001;
- При необходимости вся продукция военного и аэрокосмического назначения проходит испытания и сертификацию в лаборатории (по согласованию с заказчиком);
- Поставка специализированных компонентов военного и аэрокосмического уровня качества (Xilinx, Altera, Analog Devices, Intersil, Interpoint, Microsemi, Actel, Aeroflex, Peregrine, VPT, Syfer, Eurofarad, Texas Instruments, MS Kennedy, Miteq, Cobham, E2V, MA-COM, Hittite, Mini-Circuits, General Dynamics и др.);

Компания «Океан Электроники» является официальным дистрибьютором и эксклюзивным представителем в России одного из крупнейших производителей разъемов военного и аэрокосмического назначения «**JONHON**», а так же официальным дистрибьютором и эксклюзивным представителем в России производителя высокотехнологичных и надежных решений для передачи СВЧ сигналов «**FORSTAR**».



## JONHON

«**JONHON**» (основан в 1970 г.)

Разъемы специального, военного и аэрокосмического назначения:

(Применяются в военной, авиационной, аэрокосмической, морской, железнодорожной, горно- и нефтедобывающей отраслях промышленности)

«**FORSTAR**» (основан в 1998 г.)

ВЧ соединители, коаксиальные кабели,  
кабельные сборки и микроволновые компоненты:

(Применяются в телекоммуникациях гражданского и специального назначения, в средствах связи, РЛС, а так же военной, авиационной и аэрокосмической отраслях промышленности).



Телефон: 8 (812) 309-75-97 (многоканальный)

Факс: 8 (812) 320-03-32

Электронная почта: [ocean@oceanchips.ru](mailto:ocean@oceanchips.ru)

Web: <http://oceanchips.ru/>

Адрес: 198099, г. Санкт-Петербург, ул. Калинина, д. 2, корп. 4, лит. А