





# CODE 54 - TINEL-LOCK BACKSHELL

**TXR54AB00-1608AI-S**

SERIES \_\_\_\_\_  
 TXR: RING INCLUDED  
 (SEE RING OPTION)  
 TX: RING NOT INCLUDED  
 CONNECTOR INTERFACE \_\_\_\_\_  
 MATERIAL \_\_\_\_\_  
 REFER TO CH00-0250-008  
 FINISH \_\_\_\_\_  
 REFER TO CH00-0250-008  
 ANGLE \_\_\_\_\_  
 DASH NUMBER (TABLE 1) \_\_\_\_\_  
 ENTRY SIZE (TABLE 2) \_\_\_\_\_  
 RING OPTION \_\_\_\_\_  
 AI - TO SUIT SINGLE BRAID  
 BI - TO SUIT DOUBLE BRAID  
 FOR TX, LEAVE BLANK  
 MODIFICATION CODE \_\_\_\_\_  
 REFER TO CH00-0250-008

## NOTES:

1. THIS PRODUCT IS DESIGNED TO TERMINATE A BRAIDED CABLE SHIELD AND A HEAT SHRINKABLE LIPPED BOOT TO A CONNECTOR.
2. FOR ADDITIONAL DIMENSIONS, ORDERING INFORMATION AND MODIFICATIONS, SEE CH00-0250-008.
3. SEE DRAWING TR FOR DETAIL ON TINEL-LOCK RING, RINGS ARE DESIGNED TO BE HEATED ELECTRICALLY, ALL RINGS ARE MARKED WITH THERMOCHROMIC PAINT WHICH CHANGES COLOUR WHEN INSTALLATION TEMPERATURE IS REACHED.
4. BACKSHELL TO BE PERMANENTLY MARKED/BAGGED AND LABELLED WITH CODE IDENTIFICATION NUMBER AND PART NUMBER LESS RING DESIGNATOR. (e.g. 06090-TXR54AB00-1206). RING SHALL BEAR NO MARKING.
5. FOR LARGER ENTRY SIZES, A 2 PIECE BACKSHELL ASSEMBLY (TYPE 2) IS SUPPLIED.
6. BACKSHELL MATES TO MIL-C-81703, SERIES III, MS3424, MS3446, MS3464, MS3467, MS3468
7. BACKSHELL MATES TO MIL-C-5015G, MS3400 SERIES, CLASS D, E, K, L, U & W, MS3400, MS3401, MS3404, MS3406 MS3424, MS3446, MS3464, MS3467, MS3468, MS3450, MS3451, MS3454, MS3456, MS3470, MS3471, MS3472, MS3474, MS3475, MS3476. MIL-C-83723, SERIES II, CLASS A & L. MIL-C-83723, SERIES I & II, CLASS A, G, K, R & S: M83723/1, /2, /3, /4, /5, /6, /7, /8, /13, /14, /36, /37, /38, /39, /40, /41, /42, /43, /48, /49, /65, /66, /67, /68, /69, /70, /71, /72, /73, /74, /75, /76, /77, /78, /82, /83, /84, /85, /86, /87, /91, /92, /95, /97, /98, (MS3155 CONTROLLED INTERFACE).
8. THESE DIMENSIONS APPLY IF A SELF-LOCKING COUPLING NUT IS USED.

DRAWN	K.WINCZURA	DATE	01/12/2014	 3RD ANGLE PROJECTION NOT TO SCALE	<b>TITLE:</b>  <b>TINEL-LOCK BACKSHELL</b>	 <b>Polanco</b> 
CHECKED		01/12/2014				
APPROVED	K.SHEPPARD	04/12/2014	UNLESS OTHERWISE SPECIFIED ALL DIMENSIONS IN MILLIMETRES GENERAL TOL LINEAR +/-0.25MM ANGULAR +/- 1°			
APPROVED						
<b>REVISIONS</b>					<b>ASSY USED ON:</b>  <b>MIL-DTL-26482 SERIES II / MIL-DTL-83723 SERIES I &amp; III</b>	
LTR	DESCRIPTION	DATE	APPROVED			
J	REVISED PER ECO-12-021161	04.12.12	G.WELLS			
K	REVISED PER ECO-15-002312	13.02.15	H.SMITH			
TE CAGE CODE: 06090 POLAMCO/TE CAGE CODE: U5792					TE CONNECTIVITY - POLAMCO LTD RESERVES THE RIGHT TO AMEND THIS DRAWING AND THE INFORMATION SET FORTH HEREON AT ANY TIME. USERS SHOULD INDEPENDENTLY EVALUATE THE SUITABILITY OF THE PRODUCT FOR THEIR APPLICATION.	DRAWING NO: <b>TXR54</b>
					DRAWING REV: <b>K</b>	SHT <b>1</b>



STAINLESS STEEL TEETH VIEW



STRAIGHT BACKSHELL - TYPE 1



STRAIGHT BACKSHELL - TYPE 2



45° BACKSHELL - TYPE 1



45° BACKSHELL - TYPE 2



90° BACKSHELL - TYPE 1



90° BACKSHELL - TYPE 2

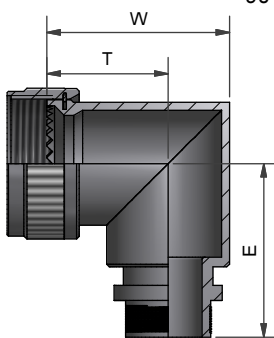

90° BACKSHELL - TYPE 1  
STAINLESS STEEL AND  
NICKEL ALUMINIUM BRONZE

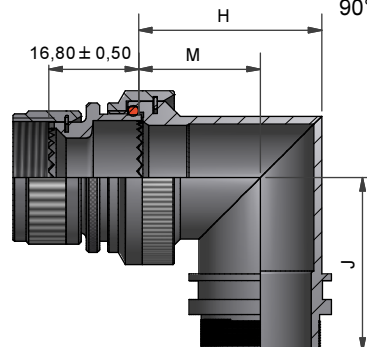

90° BACKSHELL - TYPE 2  
STAINLESS STEEL AND  
NICKEL ALUMINIUM BRONZE

DRAWN	K.WINCZURA	DATE	01/12/2014
CHECKED		DATE	01/12/2014
APPROVED	K.SHEPPARD	DATE	04/12/2014
APPROVED			



3RD ANGLE PROJECTION  
NOT TO SCALE

UNLESS OTHERWISE SPECIFIED  
ALL DIMENSIONS IN MILLIMETRES  
GENERAL TOL  
LINEAR +/-0,25MM  
ANGULAR +/- 1°

REVISIONS			
LTR	DESCRIPTION	DATE	APPROVED
J	REVISED PER ECO-12-021161	04.12.12	G.WELLS
K	REVISED PER ECO-15-002312	13.02.15	H.SMITH

TITLE:

TINEL-LOCK BACKSHELL

ASSY USED ON:

MIL-DTL-26482 SERIES II / MIL-DTL-83723 SERIES I & III

TE CAGE CODE: 06090  
POLAMCO/TE CAGE CODE: U5792

TE CONNECTIVITY - POLAMCO LTD RESERVES THE RIGHT TO AMEND THIS DRAWING AND THE INFORMATION SET FORTH HEREON AT ANY TIME. USERS SHOULD INDEPENDENTLY EVALUATE THE SUITABILITY OF THE PRODUCT FOR THEIR APPLICATION.

DRAWING NO:  
TXR54

DRAWING REV:  
K

SHT  
2



Polamco



# MODIFICATION S (SELF-LOCKING COUPLING NUT)



BACKSHELL - TYPE 1



BACKSHELL - TYPE 2



TABLE 1

ORDER NO.	SHELL SIZE		A THREAD	ØB MAX	ØB MAX (8)	MAX ENTRY	C ±0,5	D ±0,5	W ±0,5	T ±0,5	E ±0,5	THESE DIMENSIONS APPLY IF BACKSHELL IS STAINLESS STEEL OR NICKEL ALUMINIUM BRONZE		
	(6)	(7)										W ±0,5	T ±0,5	E ±0,5
03	3		9/16-24 UNEF	17,0	19,4	04	16,8	27,0	26,4	17,8	25,9	26,3	16,0	25,9
08		8 & 8S	1/2-20 UNF	15,6	18,0	04	16,6	26,8	24,5	17,5	26,2	22,4	17,5	26,2
10		10, 10S, 10SL	5/8-24 UNEF	18,6	21,0	06	16,8	27,5	26,5	17,8	28,0	25,0	18,8	28,0
12	7	12 & 12S	3/4-20 UNEF	21,7	25,0	08	17,3	28,0	29,0	18,7	29,5	28,3	20,4	29,5
14	12	14 & 14S	7/8-20 UNEF	24,9	28,0	08	18,1	29,0	30,5	19,0	30,3	30,4	21,5	31,0
16	19	16 & 16S	1-20 UNEF	28,2	31,0	10	19,0	29,7	34,0	21,0	32,7	33,5	23,0	32,7
18	27	18	1 1/16-18 UNEF	30,9	34,0	12	19,2	30,5	37,0	23,5	32,7	35,5	24,0	32,7
20	37	20	1 3/16-18 UNEF	34,1	36,5	14	20,1	30,9	42,0	27,0	34,3	38,8	25,7	34,3
22		22	1 5/16-18 UNEF	37,3	39,8	16	20,3	31,1	44,0	27,0	35,8	41,9	27,2	35,8
24		24	1 7/16-18 UNEF	40,4	42,0	18	21,8	32,1	45,0	27,0	37,4	44,8	28,7	37,4
28		28	1 3/4-18UNS	50,0	49,8	22	23,3	32,5	54,2	31,4	41,9	50,7	31,6	41,9
32		32	2-18 UNS	56,3	57,2	24	25,0	29,3	60,9	36,4	45,3	60,0	33,5	45,3
36		36	2 1/4-16 UN	62,7	63,6	28	26,2	30,7	67,2	38,0	48,4	65,5	36,0	48,4
40		40	2 1/2-16 UN	69,0	70,0	28	28,6	32,0	73,2	41,0	51,4	72,0	39,3	51,4
44		44	2 3/4-16 UN	75,4	75,4	28	30,1	33,7	79,5	44,1	54,6	75,5	40,8	54,6
48		48	3-16UN	81,7	81,7	28	31,3	34,9	85,8	47,2	57,7	75,5	40,8	57,7
61	61		1 1/2-18 UNEF	42,0	43,6	18	22,1	26,6	47,8	28,0	38,7	48,3	27,0	38,7

TABLE 2

ENTRY SIZE	ØZ MIN	ØS	ØY ± 0,3	ØK MAX	ØK MAX (8)	F ±0,5	G ±0,5	H ±0,5	M ±0,5	J ±0,5	THESE DIMENSIONS APPLY IF BACKSHELL IS STAINLESS STEEL OR NICKEL ALUMINIUM BRONZE		
											H ±0,5	M ±0,5	J ±0,5
04	6,35	9,49 +/-0,04	14,00	NA	NA	12,5	27,5	24,0	15,5	27,95	24,3	17,2	28,2
05	7,92	11,06 +/-0,04	15,50	21,0	24,6	12,5	27,5	24,0	15,5	27,95	24,3	17,2	28,2
06	9,53	12,66 +/-0,04	17,10	21,0	24,6	12,5	27,5	24,0	15,5	27,95	24,3	17,2	28,2
07	11,10	14,21 +/-0,07	18,70	21,0	24,6	12,5	27,5	24,0	15,5	27,95	24,3	17,2	28,2
08	12,70	15,81 +/-0,07	20,30	24,5	28,3	13,1	28,0	27,0	17,0	29,45	28,3	19,4	29,7
10	15,88	18,96 +/-0,08	23,50	29,0	32,4	13,5	29,0	31,0	19,5	31,00	31,1	21,0	31,2
12	19,05	22,14 +/-0,08	26,70	32,5	35,6	14,5	29,7	34,0	21,0	32,70	34,2	22,8	32,9
14	22,23	25,30 +/-0,08	29,80	35,5	38,5	15,5	30,5	35,0	20,0	34,25	38,5	25,3	34,5
16	25,40	28,48 +/-0,08	33,00	37,0	41,7	16,1	30,9	38,0	21,5	35,80	40,7	26,1	36,1
18	28,58	31,65 +/-0,08	36,20	40,0	43,9	16,5	31,1	42,0	24,0	37,40	43,7	27,6	37,6
20	31,75	34,83 +/-0,08	39,40	43,5	47,0	17,0	32,1	45,0	25,5	38,90	46,4	29,1	39,1
22	34,93	37,98 +/-0,08	42,50	48,5	50,0	18,5	33,3	54,5	31,0	42,00	50,0	31,0	42,0
24	38,10	41,15 +/-0,08	45,70	52,1	56,0	21,9	38,1	58,0	33,0	46,00	53,5	33,0	46,0
28	44,45	47,50 +/-0,08	52,00	58,5	61,0	26,9	44,4	65,5	36,5	51,1	60,3	36,5	51,1

DRAWN	K.WINCZURA	DATE	01/12/2014	 3RD ANGLE PROJECTION NOT TO SCALE  UNLESS OTHERWISE SPECIFIED ALL DIMENSIONS IN MILLIMETRES GENERAL TOL LINEAR +/-0,25MM ANGULAR +/- 1°
CHECKED		DATE	01/12/2014	
APPROVED	K.SHEPPARD	DATE	04/12/2014	
APPROVED				
REVISIONS				
LTR	DESCRIPTION	DATE	APPROVED	
J	REVISED PER ECO-12-021161	04.12.12	G.WELLS	
K	REVISED PER ECO-15-002312	13.02.15	H.SMITH	
TE CAGE CODE: 06090 POLAMCO/TE CAGE CODE: U5792				

TITLE:  <b>TINEL-LOCK BACKSHELL</b>  ASSY USED ON:  <b>MIL-DTL-26482 SERIES II / MIL-DTL-83723 SERIES I &amp; III</b>	 <b>Polamco</b>  <b>TE connectivity</b>
TE CONNECTIVITY - POLAMCO LTD RESERVES THE RIGHT TO AMEND THIS DRAWING AND THE INFORMATION SET FORTH HEREON AT ANY TIME. USERS SHOULD INDEPENDENTLY EVALUATE THE SUITABILITY OF THE PRODUCT FOR THEIR APPLICATION.	
DRAWING NO:	<b>TXR54</b>
DRAWING REV:	<b>K</b>
SHT	<b>3</b>

Компания «Океан Электроники» предлагает заключение долгосрочных отношений при поставках импортных электронных компонентов на взаимовыгодных условиях!

Наши преимущества:

- Поставка оригинальных импортных электронных компонентов напрямую с производств Америки, Европы и Азии, а так же с крупнейших складов мира;
- Широкая линейка поставок активных и пассивных импортных электронных компонентов (более 30 млн. наименований);
- Поставка сложных, дефицитных, либо снятых с производства позиций;
- Оперативные сроки поставки под заказ (от 5 рабочих дней);
- Экспресс доставка в любую точку России;
- Помощь Конструкторского Отдела и консультации квалифицированных инженеров;
- Техническая поддержка проекта, помощь в подборе аналогов, поставка прототипов;
- Поставка электронных компонентов под контролем ВП;
- Система менеджмента качества сертифицирована по Международному стандарту ISO 9001;
- При необходимости вся продукция военного и аэрокосмического назначения проходит испытания и сертификацию в лаборатории (по согласованию с заказчиком);
- Поставка специализированных компонентов военного и аэрокосмического уровня качества (Xilinx, Altera, Analog Devices, Intersil, Interpoint, Microsemi, Actel, Aeroflex, Peregrine, VPT, Syfer, Eurofarad, Texas Instruments, MS Kennedy, Miteq, Cobham, E2V, MA-COM, Hittite, Mini-Circuits, General Dynamics и др.);

Компания «Океан Электроники» является официальным дистрибьютором и эксклюзивным представителем в России одного из крупнейших производителей разъемов военного и аэрокосмического назначения «JONHON», а так же официальным дистрибьютором и эксклюзивным представителем в России производителя высокотехнологичных и надежных решений для передачи СВЧ сигналов «FORSTAR».



## JONHON

«JONHON» (основан в 1970 г.)

Разъемы специального, военного и аэрокосмического назначения:

(Применяются в военной, авиационной, аэрокосмической, морской, железнодорожной, горно- и нефтедобывающей отраслях промышленности)

«FORSTAR» (основан в 1998 г.)

ВЧ соединители, коаксиальные кабели, кабельные сборки и микроволновые компоненты:

(Применяются в телекоммуникациях гражданского и специального назначения, в средствах связи, РЛС, а так же военной, авиационной и аэрокосмической отраслях промышленности).



Телефон: 8 (812) 309-75-97 (многоканальный)

Факс: 8 (812) 320-03-32

Электронная почта: [ocean@oceanchips.ru](mailto:ocean@oceanchips.ru)

Web: <http://oceanchips.ru/>

Адрес: 198099, г. Санкт-Петербург, ул. Калинина, д. 2, корп. 4, лит. А