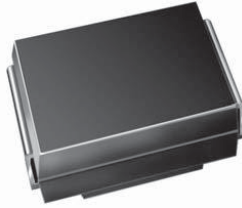

## Surface Mount Fast Switching Rectifier

**DO-214AA (SMB)**

### FEATURES

- Low profile package
- Ideal for automated placement
- Glass passivated chip junction
- Fast switching for high efficiency
- High forward surge capability
- Meets MSL level 1, per J-STD-020, LF maximum peak of 260 °C
- AEC-Q101 qualified
- Material categorization: For definitions of compliance please see [www.vishay.com/doc?99912](http://www.vishay.com/doc?99912)

**RoHS**  
COMPLIANT

### TYPICAL APPLICATIONS

For use in fast switching rectification of power supply, inverters, converters, and freewheeling diodes for consumer, automotive, and telecommunication.

### MECHANICAL DATA

**Case:** DO-214AA (SMB)

Molding compound meets UL 94 V-0 flammability rating

Base P/N-E3 - RoHS-compliant, commercial grade

Base P/NHE3 - RoHS-compliant, AEC-Q101 qualified

**Terminals:** Matte tin plated leads, solderable per J-STD-002 and JESD 22-B102

E3 suffix meets JESD 201 class 1A whisker test, HE3 suffix meets JESD 201 class 2 whisker test

**Polarity:** Color band denotes cathode end

PRIMARY CHARACTERISTICS	
$I_{F(AV)}$	1.5 A
$V_{RRM}$	50 V to 800 V
$I_{FSM}$	50 A
$t_{rr}$	150 ns, 250 ns, 500 ns
$V_F$	1.3 V
$T_J \text{ max.}$	150 °C

MAXIMUM RATINGS ( $T_A = 25\text{ °C}$ unless otherwise noted)								
PARAMETER	SYMBOL	RS2A	RS2B	RS2D	RS2G	RS2J	RS2K	UNIT
Device marking code		RA	RB	RD	RG	RJ	RK	
Maximum repetitive peak reverse voltage	$V_{RRM}$	50	100	200	400	600	800	V
Maximum RMS voltage	$V_{RMS}$	35	70	140	280	420	500	V
Maximum DC blocking voltage	$V_{DC}$	50	100	200	400	600	800	V
Maximum average forward rectified current at $T_L = 100\text{ °C}$	$I_{F(AV)}$	1.5						A
Peak forward surge current 8.3 ms single half sine-wave superimposed on rated load	$I_{FSM}$	50						A
Operating junction and storage temperature range	$T_J, T_{STG}$	- 55 to + 150						°C



ELECTRICAL CHARACTERISTICS (T <sub>A</sub> = 25 °C unless otherwise noted)									
PARAMETER	TEST CONDITIONS	SYMBOL	RS2A	RS2B	RS2D	RS2G	RS2J	RS2K	UNIT
Maximum instantaneous forward voltage	1.5 A	V <sub>F</sub>	1.3						V
Maximum DC reverse current at rated DC blocking voltage	T <sub>A</sub> = 25 °C	I <sub>R</sub>	5.0						μA
	T <sub>A</sub> = 125 °C		200						
Maximum reverse recovery time	I <sub>F</sub> = 0.5 A, I <sub>R</sub> = 1.0 A, I <sub>rr</sub> = 0.25 A	t <sub>rr</sub>	150				250	500	ns
Typical junction capacitance	4.0 V, 1 MHz	C <sub>J</sub>	20				17		pF

THERMAL CHARACTERISTICS (T <sub>A</sub> = 25 °C unless otherwise noted)									
PARAMETER	SYMBOL	RS2A	RS2B	RS2D	RS2G	RS2J	RS2K	UNIT	
Typical thermal resistance	R <sub>θJA</sub> <sup>(1)</sup>	55						°C/W	
	R <sub>θJL</sub> <sup>(1)</sup>	18							

**Note**

<sup>(1)</sup> Thermal resistance from junction to ambient and from junction to lead mounted on PCB with 0.27" x 0.27" (7.0 mm x 7.0 mm) copper pad

ORDERING INFORMATION (Example)				
PREFERRED P/N	UNIT WEIGHT (g)	PREFERRED PACKAGE CODE	BASE QUANTITY	DELIVERY MODE
RS2J-E3/52T	0.096	52T	750	7" diameter plastic tape and reel
RS2J-E3/5BT	0.096	5BT	3200	13" diameter plastic tape and reel
RS2JHE3/52T <sup>(1)</sup>	0.096	52T	750	7" diameter plastic tape and reel
RS2JHE3/5BT <sup>(1)</sup>	0.096	5BT	3200	13" diameter plastic tape and reel

**Note**

<sup>(1)</sup> AEC-Q101 qualified

**RATINGS AND CHARACTERISTICS CURVES**

(T<sub>A</sub> = 25 °C unless otherwise noted)

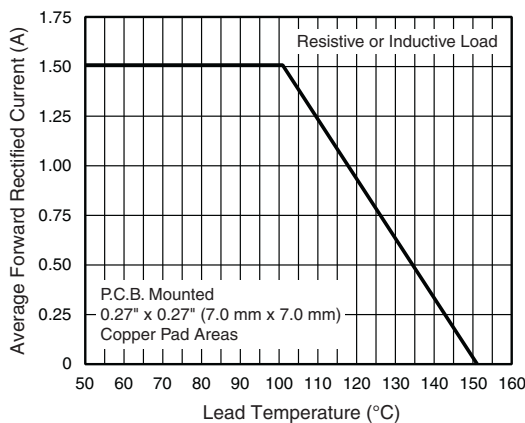

Fig. 1 - Forward Current Derating Curve

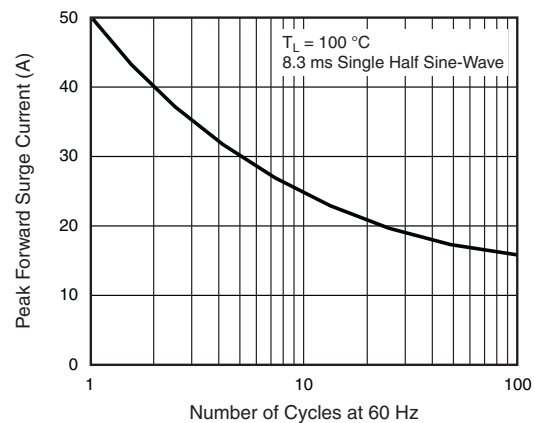

Fig. 2 - Maximum Non-Repetitive Peak Forward Surge Current

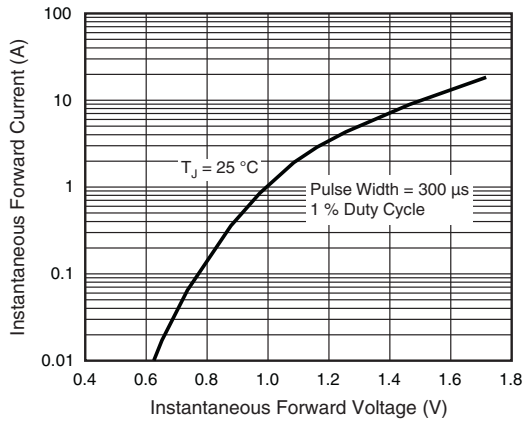

Fig. 3 - Typical Instantaneous Forward Characteristics

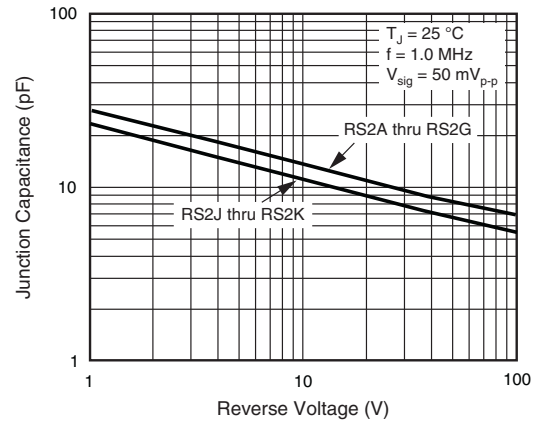

Fig. 5 - Typical Junction Capacitance

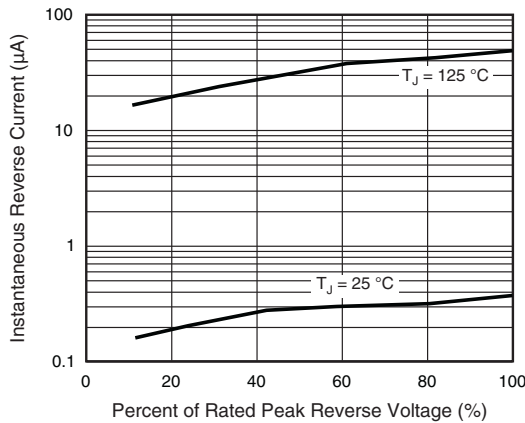
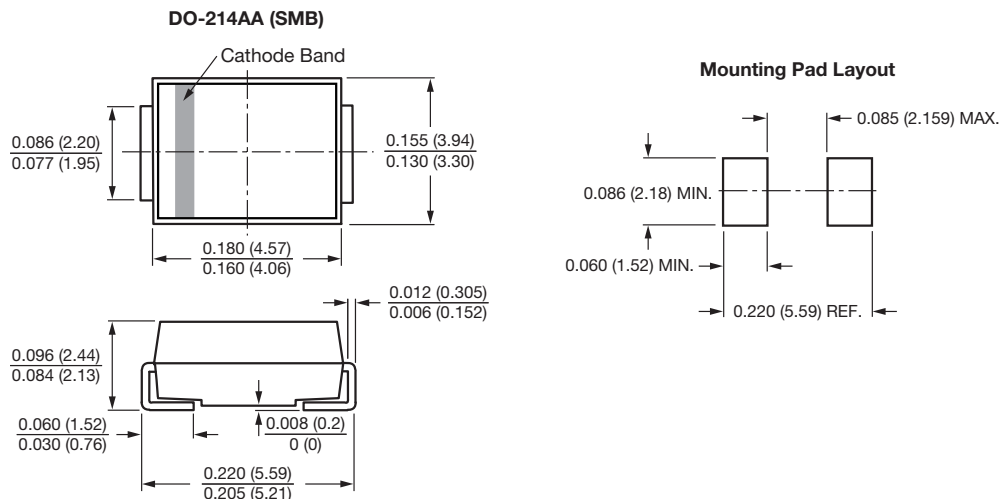

Fig. 4 - Typical Reverse Characteristics

## PACKAGE OUTLINE DIMENSIONS in inches (millimeters)





## Disclaimer

ALL PRODUCT, PRODUCT SPECIFICATIONS AND DATA ARE SUBJECT TO CHANGE WITHOUT NOTICE TO IMPROVE RELIABILITY, FUNCTION OR DESIGN OR OTHERWISE.

Vishay Intertechnology, Inc., its affiliates, agents, and employees, and all persons acting on its or their behalf (collectively, "Vishay"), disclaim any and all liability for any errors, inaccuracies or incompleteness contained in any datasheet or in any other disclosure relating to any product.

Vishay makes no warranty, representation or guarantee regarding the suitability of the products for any particular purpose or the continuing production of any product. To the maximum extent permitted by applicable law, Vishay disclaims (i) any and all liability arising out of the application or use of any product, (ii) any and all liability, including without limitation special, consequential or incidental damages, and (iii) any and all implied warranties, including warranties of fitness for particular purpose, non-infringement and merchantability.

Statements regarding the suitability of products for certain types of applications are based on Vishay's knowledge of typical requirements that are often placed on Vishay products in generic applications. Such statements are not binding statements about the suitability of products for a particular application. It is the customer's responsibility to validate that a particular product with the properties described in the product specification is suitable for use in a particular application. Parameters provided in datasheets and/or specifications may vary in different applications and performance may vary over time. All operating parameters, including typical parameters, must be validated for each customer application by the customer's technical experts. Product specifications do not expand or otherwise modify Vishay's terms and conditions of purchase, including but not limited to the warranty expressed therein.

Except as expressly indicated in writing, Vishay products are not designed for use in medical, life-saving, or life-sustaining applications or for any other application in which the failure of the Vishay product could result in personal injury or death. Customers using or selling Vishay products not expressly indicated for use in such applications do so at their own risk and agree to fully indemnify and hold Vishay and its distributors harmless from and against any and all claims, liabilities, expenses and damages arising or resulting in connection with such use or sale, including attorneys fees, even if such claim alleges that Vishay or its distributor was negligent regarding the design or manufacture of the part. Please contact authorized Vishay personnel to obtain written terms and conditions regarding products designed for such applications.

No license, express or implied, by estoppel or otherwise, to any intellectual property rights is granted by this document or by any conduct of Vishay. Product names and markings noted herein may be trademarks of their respective owners.

## Material Category Policy

**Vishay Intertechnology, Inc. hereby certifies that all its products that are identified as RoHS-Compliant fulfill the definitions and restrictions defined under Directive 2011/65/EU of The European Parliament and of the Council of June 8, 2011 on the restriction of the use of certain hazardous substances in electrical and electronic equipment (EEE) - recast, unless otherwise specified as non-compliant.**

**Please note that some Vishay documentation may still make reference to RoHS Directive 2002/95/EC. We confirm that all the products identified as being compliant to Directive 2002/95/EC conform to Directive 2011/65/EU.**

Компания «Океан Электроники» предлагает заключение долгосрочных отношений при поставках импортных электронных компонентов на взаимовыгодных условиях!

Наши преимущества:

- Поставка оригинальных импортных электронных компонентов напрямую с производств Америки, Европы и Азии, а так же с крупнейших складов мира;
- Широкая линейка поставок активных и пассивных импортных электронных компонентов (более 30 млн. наименований);
- Поставка сложных, дефицитных, либо снятых с производства позиций;
- Оперативные сроки поставки под заказ (от 5 рабочих дней);
- Экспресс доставка в любую точку России;
- Помощь Конструкторского Отдела и консультации квалифицированных инженеров;
- Техническая поддержка проекта, помощь в подборе аналогов, поставка прототипов;
- Поставка электронных компонентов под контролем ВП;
- Система менеджмента качества сертифицирована по Международному стандарту ISO 9001;
- При необходимости вся продукция военного и аэрокосмического назначения проходит испытания и сертификацию в лаборатории (по согласованию с заказчиком);
- Поставка специализированных компонентов военного и аэрокосмического уровня качества (Xilinx, Altera, Analog Devices, Intersil, Interpoint, Microsemi, Actel, Aeroflex, Peregrine, VPT, Syfer, Eurofarad, Texas Instruments, MS Kennedy, Miteq, Cobham, E2V, MA-COM, Hittite, Mini-Circuits, General Dynamics и др.);

Компания «Океан Электроники» является официальным дистрибьютором и эксклюзивным представителем в России одного из крупнейших производителей разъемов военного и аэрокосмического назначения «JONHON», а так же официальным дистрибьютором и эксклюзивным представителем в России производителя высокотехнологичных и надежных решений для передачи СВЧ сигналов «FORSTAR».



## JONHON

«JONHON» (основан в 1970 г.)

Разъемы специального, военного и аэрокосмического назначения:

(Применяются в военной, авиационной, аэрокосмической, морской, железнодорожной, горно- и нефтедобывающей отраслях промышленности)

«FORSTAR» (основан в 1998 г.)

ВЧ соединители, коаксиальные кабели, кабельные сборки и микроволновые компоненты:

(Применяются в телекоммуникациях гражданского и специального назначения, в средствах связи, РЛС, а так же военной, авиационной и аэрокосмической отраслях промышленности).



Телефон: 8 (812) 309-75-97 (многоканальный)

Факс: 8 (812) 320-03-32

Электронная почта: [ocean@oceanchips.ru](mailto:ocean@oceanchips.ru)

Web: <http://oceanchips.ru/>

Адрес: 198099, г. Санкт-Петербург, ул. Калинина, д. 2, корп. 4, лит. А