

R15

Industrial Electromagnetic Relays



- Contacts AgNi
- For plug-in sockets, 35 mm rail mount or on panel mounting.
- Cadmium-free contacts-R15 DPDT, R15 3PDT, R15 4PDT relays
- WT (mechanical indicator and lockable front test button) - standard features of R15 DPDT, R15 3PDT relays in cover, for plug-in sockets.
- Relays may be provided with the test buttons (no latching) and plugs (see page 115).
- AUCOTEAM, GmbH Berlin - railway standards.



Contact Data

Number and type of contacts		DPDT	3PDT	4PDT
Contact material		AgNi	AgNi	AgCdO
Rated / max. switching voltage AC		250 V / 440 V	250 V / 440 V	250 V / 440 V
Min. switching voltage		10 V	10 V	10 V
Rated load (capacity)	AC1	10 A / 250 V AC; 10 A / 277 V AC UL 508	10 A / 250 V AC; 10 A / 277 V AC UL 508	10 A / 250 V AC; 10 A / 277 V AC UL 508
	AC15	3 A / 120 V; 1.5 A / 240 V (B300)	3 A / 120 V; 1.5 A / 240 V (B300)	3 A / 120 V; 1.5 A / 240 V (B300)
	AC3	370 W (single-phase motor. 1/2 HP / 240 V AC UL 508)	370 W (single-phase motor. 1/2 HP / 240 V AC UL 508)	370 W (single-phase motor. 1/2 HP / 240 V AC UL 508)
	DC1	10 A / 24 V DC (see Fig. 3)	10 A / 24 V DC (see Fig. 3)	10 A / 24 V DC (see Fig. 3)
	DC13	0.22 A / 120 V; 0.1 A / 250 V (R300)	0.22 A / 120 V; 0.1 A / 250 V (R300)	0.22 A / 120 V; 0.1 A / 250 V (R300)
Min. switching current		5 mA	5 mA	10 mA
Max. inrush current		20 A	20 A	20 A
Rated current		10A	10A	10A
Max. breaking capacity	AC1	2500 VA	2500 VA	2500 VA
Min. breaking capacity		0.3 W	0.3 W	0.5 W
Contact resistance		≤ 100 mΩ	≤ 100 mΩ	≤ 100 mΩ
Max. operating frequency				
• at rated load	AC1	1200 cycles/hour	1200 cycles/hour	1200 cycles/hour
• no load		12000 cycles/hour	12000 cycles/hour	12000 cycles/hour

Coil Data

Rated voltage	50/60 Hz AC	6 ... 240 V	6 ... 240 V	6 ... 240 V
	DC	6 ... 220 V	6 ... 220 V	6 ... 220 V
Must release voltage		AC: ≥ 0.15 U _n ; DC: ≥ 0.1 U _n	AC: ≥ 0.15 U _n ; DC: ≥ 0.1 U _n	AC: ≥ 0.15 U _n ; DC: ≥ 0.1 U _v
Operating range of supply voltage		see page 68	see page 68	see page 68
Rated power consumption		AC: 2.8 VA 50 Hz; 2.5 VA 60 Hz; DC: 1.5 W	AC: 2.8 VA 50 Hz; 2.5 VA 60 Hz; DC: 1.5 W	AC: 2.8 VA 50 Hz; 2.5 VA 60 Hz; DC: 1.5 W

Insulation

Insulation rated voltage		250 V AC	250 V AC	250 V AC
Rated surge voltage		2500 V 1.2 / 50 μs	2500 V 1.2 / 50 μs	2500 V 1.2 / 50 μs
Overvoltage category		III	III	III
Insulation pollution degree		3	3	3
Dielectric strength				
• between coil and contacts		2500 V AC type of insulation: basic	2500 V AC type of insulation: basic	2500 V AC type of insulation: basic
• contact clearance		1500 V AC type of clearance: micro-disco.	1500 V AC type of clearance: micro-disco.	1500 V AC type of clearance: micro-disco.
• pole - pole		2000 V AC type of insulation: basic	2000 V AC type of insulation: basic	2000 V AC type of insulation: basic
Contact - coil distance				
• clearance		≥ 3 mm	≥ 3 mm	≥ 3 mm
• creepage		≥ 4.2 mm	≥ 4.2 mm	≥ 3.2 mm

General Data

Operating / release time (typical)		AC: 12 ms / 10 ms; DC: 18 ms / 7 ms	AC: 12 ms / 10 ms; DC: 18 ms / 7 ms	AC: 12 ms / 10 ms; DC: 18 ms / 7 ms
Electrical life				
• resistive AC1		> 2 x 10 ⁵ ; 10 A. 250 V AC	> 2 x 10 ⁵ ; 10 A. 250 V AC	> 2 x 10 ⁵ ; 10 A. 250 V AC
• cos		see Fig. 2	see Fig. 2	see Fig. 2
Mechanical life (cycles)		> 2 x 10 ⁷	> 2 x 10 ⁷	> 2 x 10 ⁷
Dimensions (L x W x H)		35 x 35 x 54.4 mm	35 x 35 x 54.4 mm	35 x 42.5 x 54.5 mm
Weight		83 g	83 g	95 g
Ambient temperature				
• storage		-40...+85 °C	-40...+85 °C	-40...+85 °C
• operating		AC: -40...+55 °C DC: -40...+70 °C	AC: -40...+55 °C DC: -40...+70 °C	AC: -40...+55 °C DC: -40...+70 °C
Cover protection category		IP 40 PN-EN 60529	IP 40 PN-EN 60529	IP 40 PN-EN 60529
Environmental protection		RTI PN-EN 116000-3	RTI PN-EN 116000-3	RTI PN-EN 116000-3
Shock resistance		10 g	10 g	10 g
Vibration resistance		5 g 10...150 Hz	5 g 10...150 Hz	5 g 10...150 Hz
Solder bath temperature		max. 270 °C	max. 270 °C	max. 270 °C
Soldering time		max. 5 s	max. 5 s	max. 5 s

DPDT

CONNECTION DIAGRAM



DIMENSIONS

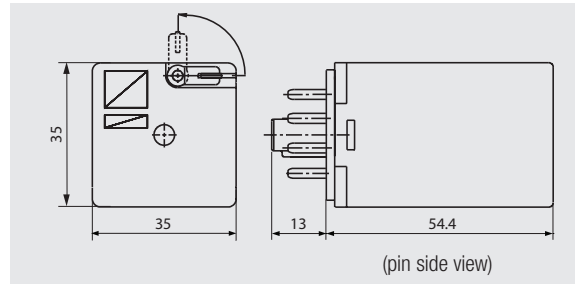

3PDT

CONNECTION DIAGRAM

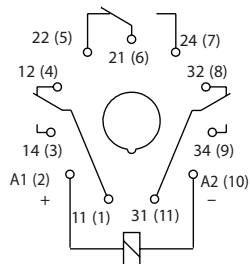

DIMENSIONS

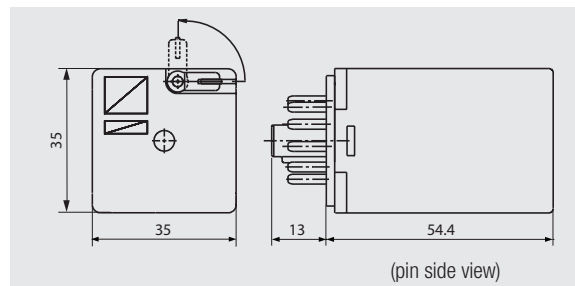

4PDT

CONNECTION DIAGRAM

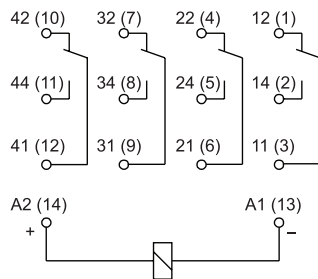

DIMENSIONS

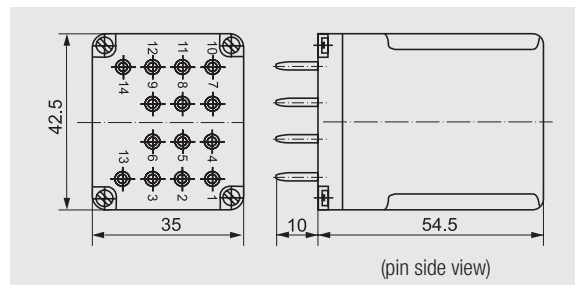

LOAD CHARTS

Electrical life at AC resistive load. Switching frequency: 1200 cycles/hour Fig. 1

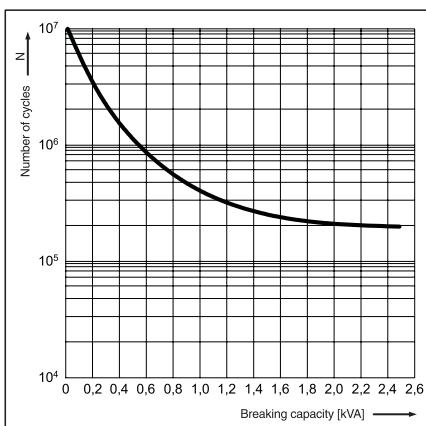

Electrical life reduction factor at AC inductive load Fig. 2

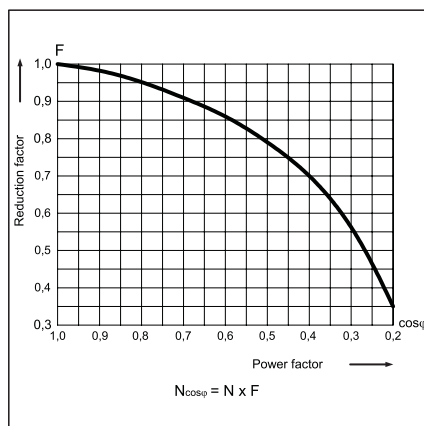

Max. DC breaking capacity A - resistive load DC1 B - inductive load L/R = 40 ms Fig. 3

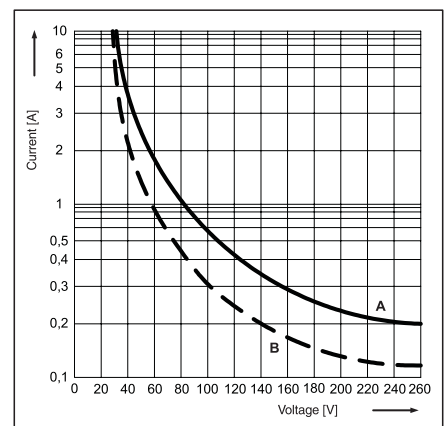

R15

Industrial Electromagnetic Relays

R15 DPDT AC 50/60Hz & DC coil

Part Number	Coil Voltage (V)	Coil Type	Coil resistance at 20 °C in Ω	Coil operating range		Options*		
				min. (at 20°C)	max. (at 55°C)	-	WT	WTL
▶ R15-2012-23-1012	12	DC	110	9.6	13.2	x		
R15-2012-23-1012-WT	12	DC	110	9.6	13.2		x	
R15-2012-23-1012-WTL	12	DC	110	9.6	13.2			x
▶ R15-2012-23-1024	24	DC	430	19.2	26.4	x		
R15-2012-23-1024-WT	24	DC	430	19.2	26.4		x	
▶ R15-2012-23-1024-WTL	24	DC	430	19.2	26.4			x
R15-2012-23-1110	110	DC	9200	88.0	121.0	x		
R15-2012-23-1110-WT	110	DC	9200	88.0	121.0		x	
R15-2012-23-1110-WTL	110	DC	9200	88.0	121.0			x
▶ R15-2012-23-5024	24	AC 50/60Hz	75	19.2	26.4	x		
R15-2012-23-5024-WT	24	AC 50/60Hz	75	19.2	26.4		x	
R15-2012-23-5024-WTL	24	AC 50/60Hz	75	19.2	26.4			x
▶ R15-2012-23-5120	120	AC 50/60Hz	1910	96.0	132.0	x		
R15-2012-23-5120-WT	120	AC 50/60Hz	1910	96.0	132.0		x	
▶ R15-2012-23-5120-WTL	120	AC 50/60Hz	1910	96.0	132.0			x
▶ R15-2012-23-5230	230	AC 50/60Hz	7080	184.0	253.0	x		
R15-2012-23-5230-WT	230	AC 50/60Hz	7080	184.0	253.0		x	
R15-2012-23-5230-WTL	230	AC 50/60Hz	7080	184.0	253.0			x

R15 3PDT AC 50/60Hz & DC coil

Part Number	Coil Voltage (V)	Coil Type	Coil resistance at 20 °C in Ω	Coil operating range		Options*		
				min. (at 20°C)	max. (at 55°C)	-	WT	WTL
▶ R15-2013-23-1012	12	DC	110	9.6	13.2	x		
R15-2013-23-1012-WT	12	DC	110	9.6	13.2		x	
R15-2013-23-1012-WTL	12	DC	110	9.6	13.2			x
▶ R15-2013-23-1024	24	DC	430	19.2	26.4	x		
R15-2013-23-1024-WT	24	DC	430	19.2	26.4		x	
▶ R15-2013-23-1024-WTL	24	DC	430	19.2	26.4			x
R15-2013-23-1110	110	DC	9200	88.0	121.0	x		
R15-2013-23-1110-WT	110	DC	9200	88.0	121.0		x	
R15-2013-23-1110-WTL	110	DC	9200	88.0	121.0			x
▶ R15-2013-23-5024	24	AC 50/60Hz	75	19.2	26.4	x		
R15-2013-23-5024-WT	24	AC 50/60Hz	75	19.2	26.4		x	
R15-2013-23-5024-WTL	24	AC 50/60Hz	75	19.2	26.4			x
▶ R15-2013-23-5120	120	AC 50/60Hz	1910	96.0	132.0	x		
R15-2013-23-5120-WT	120	AC 50/60Hz	1910	96.0	132.0		x	
▶ R15-2013-23-5120-WTL	120	AC 50/60Hz	1910	96.0	132.0			x
▶ R15-2013-23-5230	230	AC 50/60Hz	7080	184.0	253.0	x		
R15-2013-23-5230-WT	230	AC 50/60Hz	7080	184.0	253.0		x	
R15-2013-23-5230-WTL	230	AC 50/60Hz	7080	184.0	253.0			x

R15 4PDT AC 50/60Hz & DC coil

Part Number	Coil Voltage (V)	Coil Type	Coil resistance at 20 °C in Ω	Coil operating range		Options*			
				min. (at 20°C)	max. (at 55°C)	-	K	WT	WTL
R15-1014-23-1012	12	DC	110	9.6	13.2	x			
R15-1014-23-1012-K	12	DC	110	9.6	13.2		x		
R15-1014-23-1012-L	12	DC	110	9.6	13.2			x	
R15-1014-23-1012-D	12	DC	110	9.6	13.2				x
R15-1014-23-1024	24	DC	430	19.2	26.4	x			
R15-1014-23-1024-K	24	DC	430	19.2	26.4		x		
▶ R15-1014-23-1024-L	24	DC	430	19.2	26.4			x	
R15-1014-23-1024-D	24	DC	430	19.2	26.4				x
R15-1014-23-1110	110	DC	9200	88.0	121.0	x			
R15-1014-23-1110-K	110	DC	9200	88.0	121.0		x		
R15-1014-23-1110-L	110	DC	9200	88.0	121.0			x	
R15-1014-23-1110-D	110	DC	9200	88.0	121.0				x
R15-1014-23-3024	24	AC 50Hz	72	19.2	26.4	x			
R15-1014-23-3024-K	24	AC 50Hz	72	19.2	26.4		x		
R15-1014-23-3024-L	24	AC 50Hz	72	19.2	26.4			x	
R15-1014-23-3024-D	24	AC 50Hz	72	19.2	26.4				x
R15-1014-23-3120	120	AC 50Hz	2300	96.0	132.0	x			
R15-1014-23-3120-K	120	AC 50Hz	2300	96.0	132.0		x		
R15-1014-23-3120-L	120	AC 50Hz	2300	96.0	132.0			x	
R15-1014-23-3120-D	120	AC 50Hz	2300	96.0	132.0				x
R15-1014-23-3230	230	AC 50Hz	7900	184.0	253.0	x			
R15-1014-23-3230-K	230	AC 50Hz	7900	184.0	253.0		x		
R15-1014-23-3230-L	230	AC 50Hz	7900	184.0	253.0			x	
R15-1014-23-3230-D	230	AC 50Hz	7900	184.0	253.0				x
R15-1014-23-6120	120	AC 60Hz	2000	96.0	132.0	x			
R15-1014-23-6120-K	120	AC 60Hz	2000	96.0	132.0		x		
▶ R15-1014-23-6120-L	120	AC 60Hz	2000	96.0	132.0			x	
R15-1014-23-6120-D	120	AC 60Hz	2000	96.0	132.0				x
R15-1014-23-6230	230	AC 60Hz	7000	184.0	253.0	x			
R15-1014-23-6230-K	230	AC 60Hz	7000	184.0	253.0		x		
R15-1014-23-6230-L	230	AC 60Hz	7000	184.0	253.0			x	
R15-1014-23-6230-D	230	AC 60Hz	7000	184.0	253.0				x

WT = with mechanical indicator + lockable front test button; WTL = with mechanical indicator + lockable front test button + light indicator (LED)
 K = with test button without block function; L = with light indicator (LED); D = with surge suppression element (diode); other options available upon request

▶ **BOLD** - Regular stocked items.

GZP8 for R15 DPDT

Screw terminals
 Max. tightening moment
 for the terminal: 0.5 Nm
 35 mm rail mount
 acc. to PN-EN 60715
 or on panel mounting
 73 x 38.2 x 27.2 mm Two poles
 12 A, 300 V AC



GZP8

CONNECTION DIAGRAM



DIMENSIONS

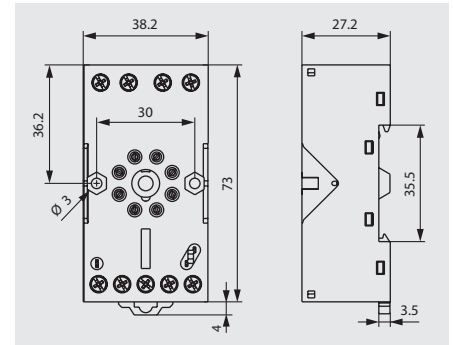

E22891



Time module COM3T



GZP-0035



GZP-0054

PZ8 for R15 DPDT

Screw terminals
 Max. tightening moment
 for the terminal: : 0.7 Nm
 35 mm rail mount
 acc. to PN-EN 60715
 or on panel mounting
 68.2 x 38 x 24.2 mm
 Two poles
 10 A, 250 V AC

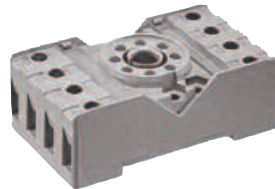

PZ8

CONNECTION DIAGRAM

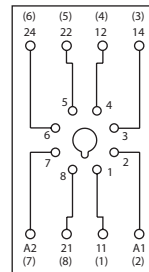

DIMENSIONS

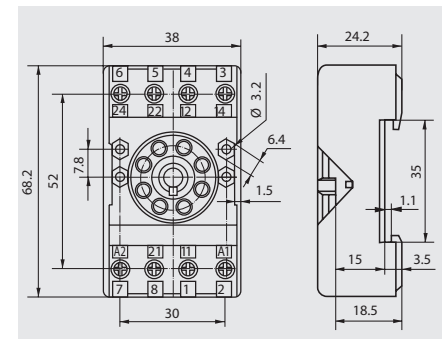

E105728



PZ11 0031

GZP11 for R15 3PDT

Screw terminals
 Max. tightening moment
 for the terminal: : 0,5 Nm
 35 mm rail mount
 acc. to PN-EN 60715
 or on panel mounting
 73 x 38.2 x 27.2 mm
 Three poles
 12 A, 300 V AC

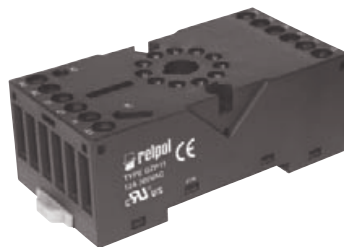

GZP11

CONNECTION DIAGRAM

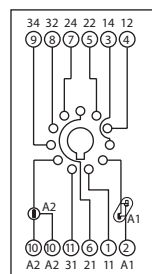

DIMENSIONS

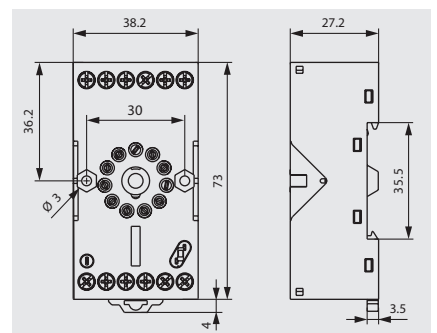

E22891



Time module COM3T



GZP-0035



GZP-0054

All accessories are sold separately.

R15

Industrial Electromagnetic Relays - Plug-in Sockets and Accessories

PZ11 for R15 3PDT

Screw terminals
 Max. tightening moment
 for the terminal: : 0.7 Nm
 35 mm rail mount
 acc. to PN-EN 60715
 or on panel mounting
 68.2 x 38 x 24.2 mm
 Three poles
 10 A, 250 V AC

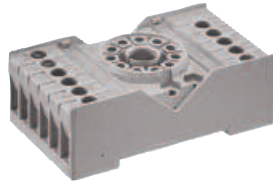

PZ11



PZ11 0031

CONNECTION DIAGRAM

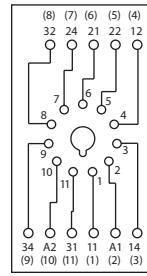

DIMENSIONS

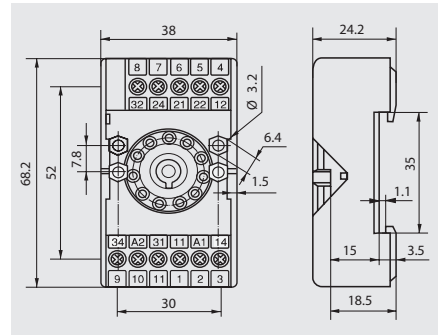

E105728

GZ14U for R15 4PDT

Screw terminals
 Max. tightening moment
 for the terminal: : 0.7 Nm
 35 mm rail mount
 acc. to PN-EN 60715
 96.8 x 46.2 x 33.3 mm
 Four poles
 10 A, 250 V AC

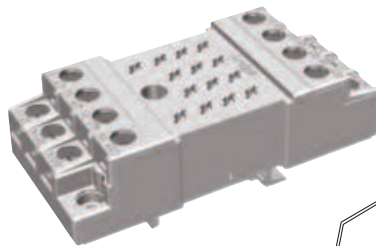

GZ14ZU



GZ14 0737

CONNECTION DIAGRAM

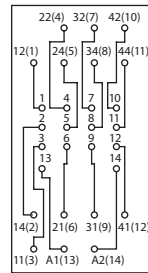

DIMENSIONS

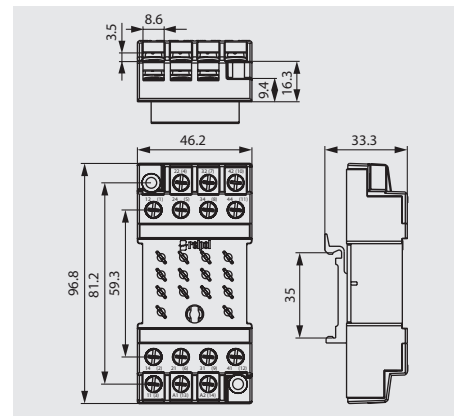

See Relay Socket Combinations on pages 104-109

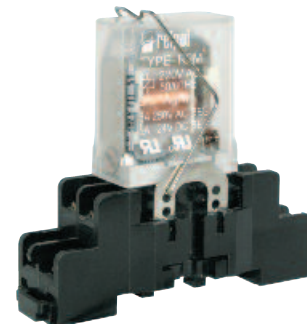
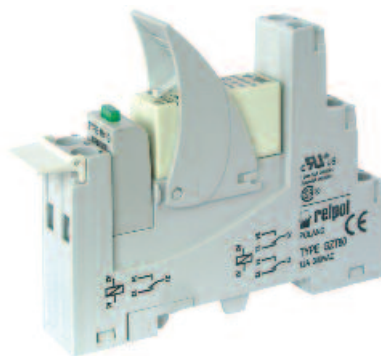

All accessories are sold separately.

Altech Custom Assemblies



Altech provides quick turnaround and competitive prices on assemblies.
For complete assemblies contact Altech.

Компания «Океан Электроники» предлагает заключение долгосрочных отношений при поставках импортных электронных компонентов на взаимовыгодных условиях!

Наши преимущества:

- Поставка оригинальных импортных электронных компонентов напрямую с производств Америки, Европы и Азии, а так же с крупнейших складов мира;
- Широкая линейка поставок активных и пассивных импортных электронных компонентов (более 30 млн. наименований);
- Поставка сложных, дефицитных, либо снятых с производства позиций;
- Оперативные сроки поставки под заказ (от 5 рабочих дней);
- Экспресс доставка в любую точку России;
- Помощь Конструкторского Отдела и консультации квалифицированных инженеров;
- Техническая поддержка проекта, помощь в подборе аналогов, поставка прототипов;
- Поставка электронных компонентов под контролем ВП;
- Система менеджмента качества сертифицирована по Международному стандарту ISO 9001;
- При необходимости вся продукция военного и аэрокосмического назначения проходит испытания и сертификацию в лаборатории (по согласованию с заказчиком);
- Поставка специализированных компонентов военного и аэрокосмического уровня качества (Xilinx, Altera, Analog Devices, Intersil, Interpoint, Microsemi, Actel, Aeroflex, Peregrine, VPT, Syfer, Eurofarad, Texas Instruments, MS Kennedy, Miteq, Cobham, E2V, MA-COM, Hittite, Mini-Circuits, General Dynamics и др.);

Компания «Океан Электроники» является официальным дистрибьютором и эксклюзивным представителем в России одного из крупнейших производителей разъемов военного и аэрокосмического назначения «JONHON», а так же официальным дистрибьютором и эксклюзивным представителем в России производителя высокотехнологичных и надежных решений для передачи СВЧ сигналов «FORSTAR».



JONHON

«JONHON» (основан в 1970 г.)

Разъемы специального, военного и аэрокосмического назначения:

(Применяются в военной, авиационной, аэрокосмической, морской, железнодорожной, горно- и нефтедобывающей отраслях промышленности)

«FORSTAR» (основан в 1998 г.)

ВЧ соединители, коаксиальные кабели,
кабельные сборки и микроволновые компоненты:

(Применяются в телекоммуникациях гражданского и специального назначения, в средствах связи, РЛС, а так же военной, авиационной и аэрокосмической отраслях промышленности).



Телефон: 8 (812) 309-75-97 (многоканальный)

Факс: 8 (812) 320-03-32

Электронная почта: ocean@oceanchips.ru

Web: <http://oceanchips.ru/>

Адрес: 198099, г. Санкт-Петербург, ул. Калинина, д. 2, корп. 4, лит. А