

# LTM4620EV

## High Efficiency, Dual 13A Step-Down Power $\mu$ Module Regulator

### DESCRIPTION

DC1498A features the LTM<sup>®</sup>4620EV, the high efficiency, high density, dual 13A, switch mode step-down power module regulator. The input voltage is from 4.5V to 16V. The output voltage is programmable from 0.6V to 2.5V. DC1498A can deliver nominal 12A output current and up to 13A maximum in each channel. As explained in the data sheet, output current derating is necessary for certain  $V_{IN}$ ,  $V_{OUT}$ , and thermal conditions. The board operates in continuous conduction mode in heavy load conditions. For high efficiency at low load currents, the MODE jumper (JP1) selects pulse-skipping mode for noise sensitive applications or Burst-Mode<sup>®</sup> operation in less noise sensitive applications. Two outputs can be connected in parallel for a single 26A output solution with optional jumper resistors. The board allows the user to program

how its output ramps up and down through the TRACK/SS pin. The output can be set up to either coincidentally or ratiometrically track with another supply's output. Remote output voltage sensing is available for improved output voltage regulation at the load point. These features and the availability of the LTM4620EV in a compact 15mm  $\times$  15mm  $\times$  4.41mm LGA package make it ideal for use in many high-density point-of-load regulation applications. The LTM4620 data sheet must be read in conjunction with this demo manual prior to working on or modifying DC1498A.

**Design files for this circuit board are available at <http://www.linear.com/demo>**

LT, LT, LTC, LTM,  $\mu$ Module, Linear Technology, the Linear logo and  $\mu$ Module are registered trademarks of Linear Technology Corporation. All other trademarks are the property of their respective owners.

### BOARD PHOTO

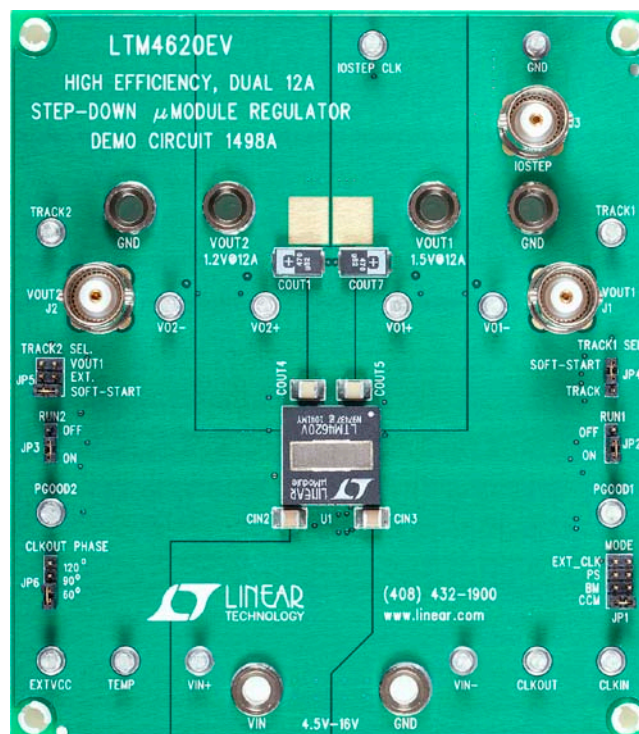

# DEMO MANUAL DC1498A

## PERFORMANCE SUMMARY (T<sub>A</sub> = 25°C)

PARAMETER	CONDITIONS	VALUE
Input Voltage Range		4.5V to 16V
Output Voltage V <sub>OUT1</sub>	V <sub>IN</sub> = 4.5V to 16V, I <sub>OUT1</sub> = 0A to 12A, JP1: CCM	1.5V ±1.5% (1.4775V to 1.5225V)
Output Voltage V <sub>OUT2</sub>	V <sub>IN</sub> = 4.5V to 16V, I <sub>OUT2</sub> = 0A to 12A, JP1: CCM	1.2V ±1.5% (1.182V to 1.218V)
Per-Channel Maximum Continuous Output Current	Derating is Necessary for Certain V <sub>IN</sub> , V <sub>OUT</sub> and Thermal Conditions. See data sheet for detail.	13A (Per Channel)
Default Operating Frequency		600kHz
Resistor Programmable Frequency Range		250kHz to 780kHz
External Clock Synchronous Frequency Range		400kHz to 780kHz
Efficiency of Channel 1	V <sub>IN</sub> = 5V, V <sub>OUT1</sub> = 1.5V, I <sub>OUT1</sub> = 13A, f <sub>SW</sub> = 600kHz	87.7% See Figure 2
Efficiency of Channel 2	V <sub>IN</sub> = 5V, V <sub>OUT2</sub> = 1.2V, I <sub>OUT2</sub> = 13A, f <sub>SW</sub> = 600kHz	85.1% See Figure 3
Load Transient of Channel 1	V <sub>IN</sub> = 12V, V <sub>OUT1</sub> = 1.5V, I <sub>SETP</sub> = 0A to 6A	See Figure 4
Load Transient of Channel 2	V <sub>IN</sub> = 12V, V <sub>OUT2</sub> = 1.2V, I <sub>SETP</sub> = 0A to 6A	See Figure 5

## QUICK START PROCEDURE

### LTM4620 Demo Cards for Up to 100A Point-of-Load Regulation

MAXIMUM OUTPUT CURRENT (A)	NUMBER OF OUTPUT VOLTAGES	NUMBER OF LTM4620 μMODULE REGULATORS ON THE BOARD	DEMO CARD NUMBER
13, 13	2	1	DC1498A
50	1	2	DC1780A-A
75	1	3	DC1780A-B
100	1	4	DC1780A-C

DC1498A is easy to set up to evaluate the performance of the LTM4620EV. Please refer to Figure 1 for proper measurement setup and follow the procedure below:

1. Place jumpers in the following positions for a typical application:

JP1	JP2	JP3	JP4	JP5	JP6
MODE	RUN1	RUN2	TRACK1 SEL.	TRACK2 SEL.	CLKOUT PHASE
CCM	ON	ON	Soft-Start	Soft-Start	90°

2. With power off, connect the input power supply, load and meters as shown in Figure 1. Preset the load to 0A and V<sub>IN</sub> supply to 12V.
3. Turn on the power supply at the input. The output voltage in channel 1 should be 1.5V ±1.5% (1.4775V to 1.525V) and the output voltage in channel 2 should be 1.2V ± 1.5% (1.182V to 1.218V).

4. Once the proper output voltage is established, adjust the load within the operating range and observe the output voltage regulation, output voltage ripple, efficiency and other parameters. Output ripple should be measured at J1 and J2 with BNC cables. 50Ω termination should be set on the oscilloscope or BNC cables.
5. (Optional) For optional load transient test, apply an adjustable pulse signal between IOSTEP CLK and GND test point. Pulse amplitude (3V to 3.5V) sets the load step current amplitude. The output transient current can be monitored at the BNC connector J3 (15mV/A). The pulse signal should have very small duty cycle (<10%) to limit the thermal stress on the transient load circuit. Switch the jumper resistors R34 or R35 (on the backside of boards) to apply load transient on channel 1 or channel 2 correspondingly.

**QUICK START PROCEDURE**

- 6. (Optional) LTM4620 can be synchronized to an external clock signal. Place the JP1 jumper on EXT\_CLK and apply a clock signal (0V to 5V, square wave) on the CLKIN test point.
- 7. (Optional) The outputs of LTM4620 can track another supply. The jumpers JP4 and JP5 allow choosing soft-start or output tracking. If tracking external voltage is selected, the corresponding test points, TRACK1 and TRACK2, need to be connected to a valid voltage signal.
- 8. (Optional) LTM4620 can be configured for a 2-phase single output at up to 26A on DC1498A. Install 0Ω resistors on R14, R17, R28, R39 and remove R7, R19. Output voltage is set by R25 based on equation  $V_{OUT} = 0.6V (1 + 60.4k/R25)$ .

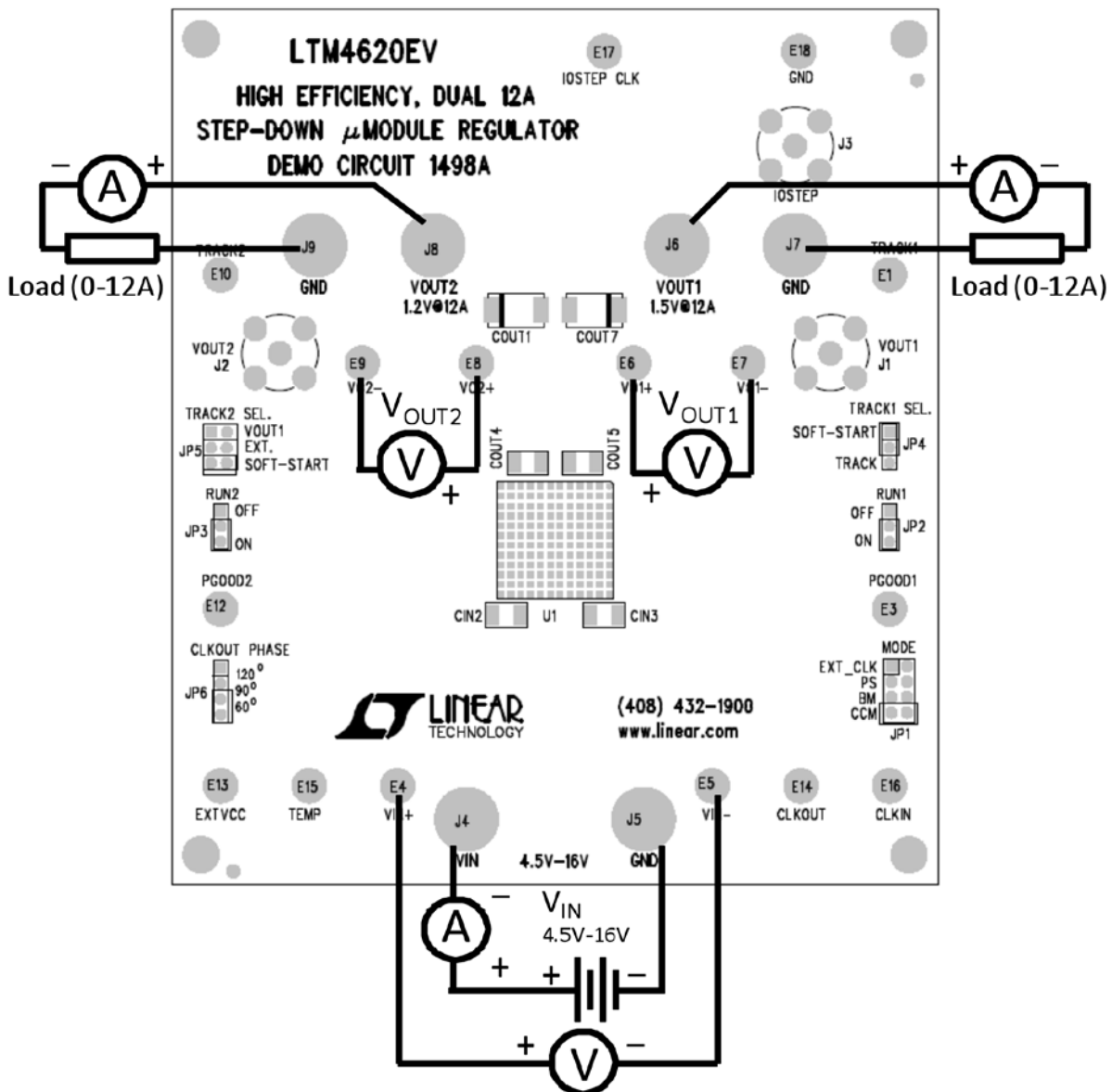
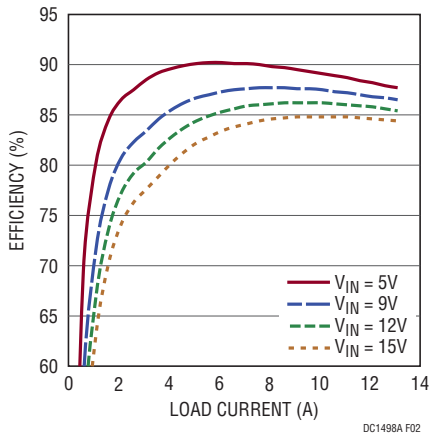
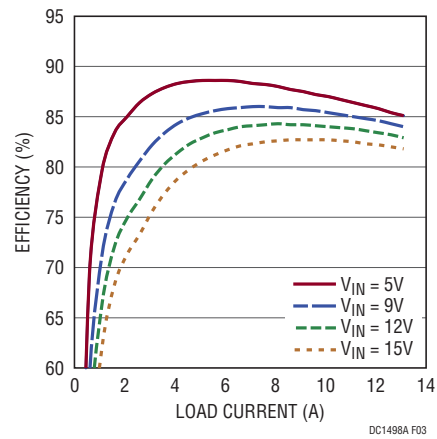

Figure 1. Test Setup of DC1498A

## QUICK START PROCEDURE



**Figure 2. Measured Efficiency on Channel 1.**  
 $V_{OUT1} = 1.5V$ ,  $f_{SW} = 600kHz$ , Channel 2 Disabled



**Figure 3. Measured Efficiency on Channel 2**  
 $V_{OUT2} = 1.2V$ ,  $f_{SW} = 600kHz$ , Channel 1 Disabled

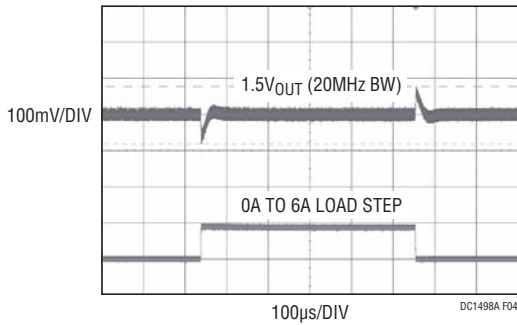

**Figure 4. Measured Channel 1**  
 0A to 6A Load Transient,  $V_{IN} = 12V$ ,  $V_{OUT1} = 1.5V$

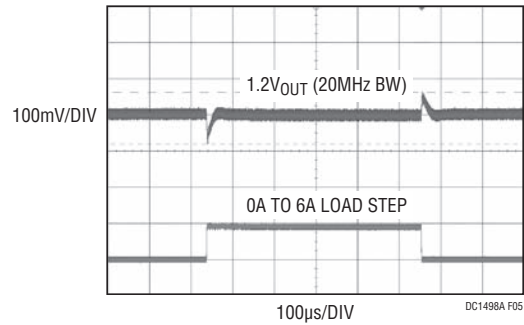

**Figure 5. Measured Channel 2**  
 0A to 6A Load Transient,  $V_{IN} = 12V$ ,  $V_{OUT2} = 1.2V$

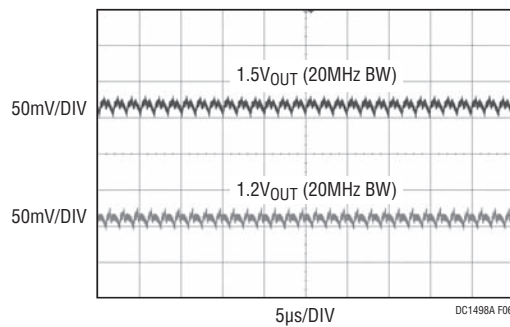

**Figure 6. Measured Output Voltage Ripple at 5V**  
 Input, 1.5V and 1.2V Output, 13A Per Channel  
 with Standard Demo Circuit Default Setup

**QUICK START PROCEDURE**

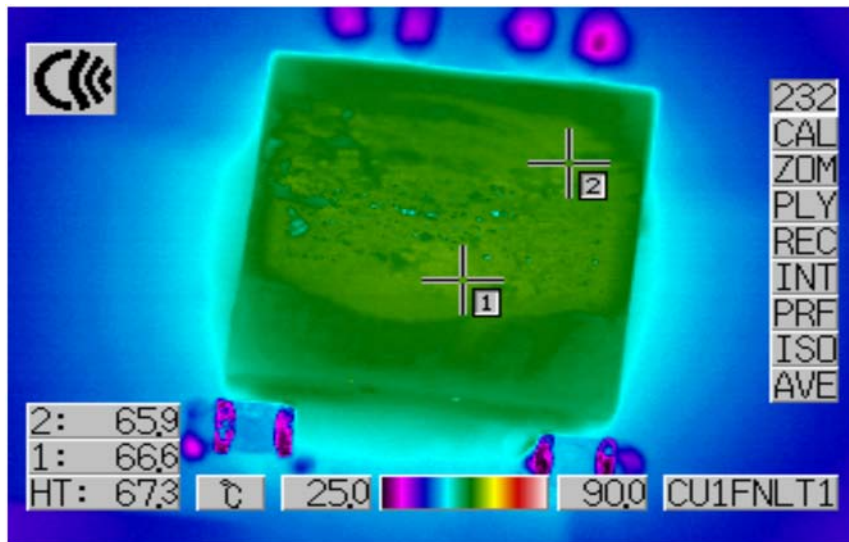

Figure 7. Thermal Capture at  $5V_{IN}$ ,  $1.5V_{OUT}$  at 12A and  $1.2V_{OUT}$  at 12A.  
Ambient Temperature = 30°C, No Airflow and No Heat Sink

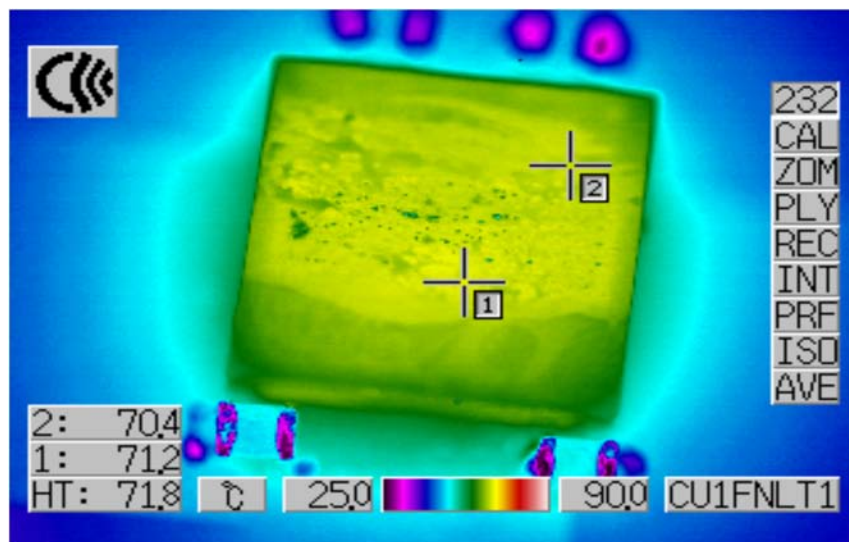

Figure 8. Thermal Capture at  $5V_{IN}$ ,  $1.5V_{OUT}$  at 13A and  $1.2V_{OUT}$  at 13A.  
Ambient Temperature = 30°C, No Airflow and No Heat Sink

**QUICK START PROCEDURE**

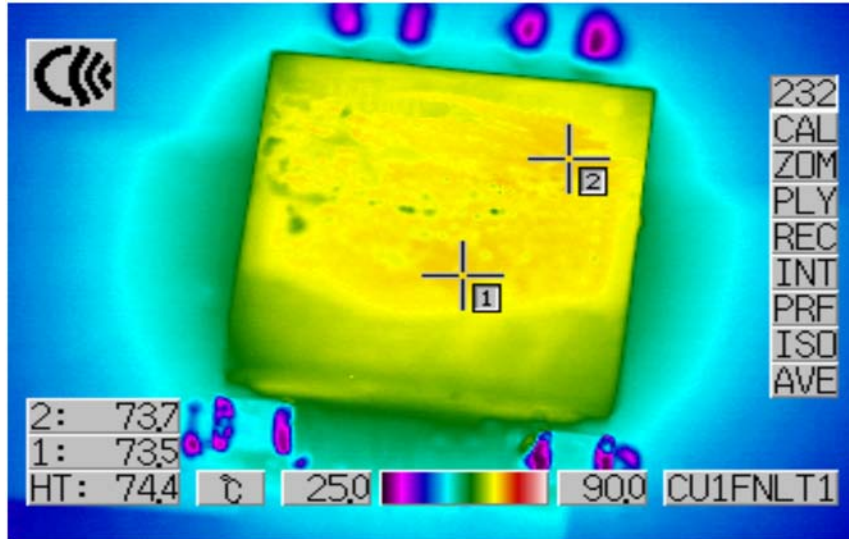

Figure 9. Thermal Capture at 12V<sub>IN</sub>, 1.5V<sub>OUT</sub> at 12A and 1.2V<sub>OUT</sub> at 12A.  
Ambient Temperature = 30°C, No Airflow and No Heat Sink

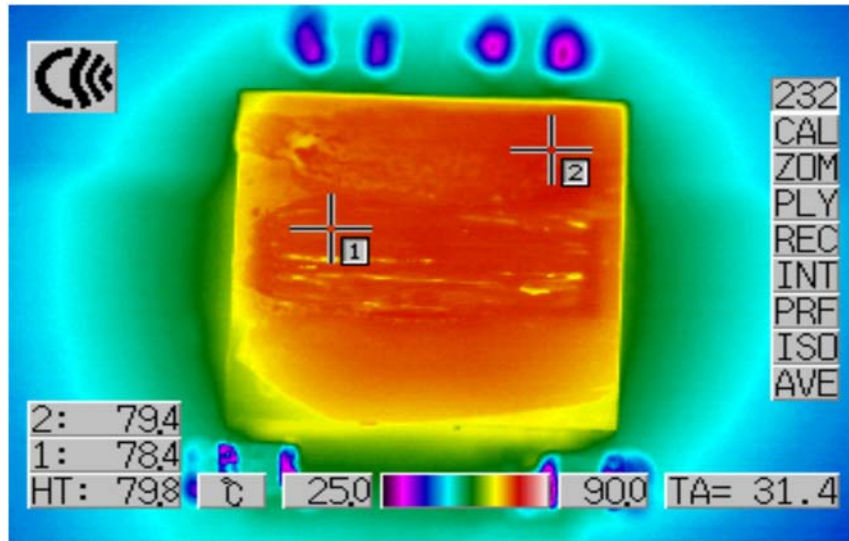

Figure 10. Thermal Capture at 12V<sub>IN</sub>, 1.5V<sub>OUT</sub> at 13A and 1.2V<sub>OUT</sub> at 13A.  
Ambient Temperature = 30°C, No Airflow and No Heat Sink

## PARTS LIST

ITEM	QTY	REFERENCE	PART DESCRIPTION	MANUFACTURER, PART NUMBER
<b>Required Circuit Components</b>				
1	4	CIN2, CIN3, CIN4, CIN5	Capacitor, X5R, 22 $\mu$ F, 25V, 10%, 1210	Murata, GRM32ER61E226KE15
2	2	COUT1, COUT7	Capacitor, 470 $\mu$ F, 4V, POSCAP, F8	Sanyo, 4TPE470MCL
3	2	COUT4, COUT5	Capacitor, X5R, 100 $\mu$ F, 6.3V, 20% 1210	AVX, 12106D107MAT2A
4	3	R3, R22, R26	Resistor, Chip, 10k, 1%, 0603	NIC, NRC06F10R0TRF
5	1	R19	Resistor, Chip, 60.4k, 1%, 0603	Vishay, CRCW060360K4FKED
6	1	R25	Resistor, Chip, 40.2k, 1%, 0603	Vishay, CRCW060340K2FKED
7	1	R30	Resistor, Chip, 158k, 1%, 0603	Vishay, CRCW0603158KFKED
8	1	U1	LTM4620EV, 15mm $\times$ 15mm $\times$ 4.41mm LGA	Linear Technology, LTM4620EV
<b>Additional Demo Board Circuit Components</b>				
9	1	CIN1	Capacitor, 150 $\mu$ F, 25V, Aluminum Electr.	Sun Electronics, 25CE150AX
10	0	COUT2, COUT3, COUT6, COUT8	Optional	1210
11	0	C1	Optional, 0805	
12	1	C2	Capacitor, X7R, 1 $\mu$ F, 25V, 10%, 0805	AVX, 08053C105KAT2A
13	2	C5, C7	Capacitor, X5R, 0.1 $\mu$ F, 25V, 10%, 0603	AVX, 06033D104KAT
14	0	C3, C4, C6, C8-C12	Optional, 0603	
15	2	C13, C14	Capacitor, X5R, 0.01 $\mu$ F, 50V, 10%, 0603	AVX, 06035C103KAT
16	2	C15, C16	Capacitor, X7R, 1 $\mu$ F, 10V, 10%, 0603	AVX, 0603ZC105KAT
17	1	Q1	N-Channel 30V MOSFET	Vishay, SUD50N03-09P
18	1	R1	Resistor, Chip, 10k, 1%, 0603	NIC, NRC06F10R0TRF
19	0	R2, R4, R6, R8, R11, R14, R16, R17, R20	R23, R28, R31, R33, R39, R40	Optional, 0603
20	4	R5, R24, R27, R36	Resistor, Chip, 10k, 1%, 0603	Vishay, CRCW060310K0FKED
21	4	R7, R21, R29, R32	Resistor, Chip, 0k, 1%, 0603	Vishay, CRCW06030000Z0ED
22	5	R9, R12, R15, R18	Resistor, Chip, 60.4k, 1%, 0603	Vishay, CRCW060360K4FKED
23	2	R10, R13	Resistor, Chip, 6.04k, 1%, 0603	Vishay, CRCW06036K04FKED
24	1	R34	Resistor, Chip, 0 $\Omega$ , 0.5W, 2010	Vishay, CRCW20200000Z0EF
25	0	R35	Optional, 2010	
26	1	R37	Resistor, Chip, 0.015 $\Omega$ , 2W, 2512	Vishay, WSL2512R0150FEA
27	0	R38	Optional, 2512	
<b>Hardware – For Demo Board Only</b>				
28	16	E1, E3-E10, E12-E16	Testpoint, Turret, 0.094" PBF	Mill-Max, 2501-2-00-80-00-00-07-0
29	3	J1, J2, J3	Conn, BNC, 5 Pins	Connex 112404
30	6	J4–J9	Jack Banana	Keystone, 575-4
31	1	JP1	Header 4 Pin 0.079 Double Row	Samtec, TMM104-02-L-D
32	1	JP6	Header 4 Pin 0.079 Single Row	Samtec, TMM104-02-L-S
33	3	JP2, JP3, JP4	Header 3 Pin 0.079 Single Row	Samtec, TMM103-02-L-S
34	1	JP5	Header 3 Pin 0.079 Double Row	Samtec, TMM-103-02-L-D
35	6	XJP1–XJP6	Shunt, 0.079" Center	Samtec, 2SN-BK-G
36	4	(Stand-Off)	Stand-Off, Nylon 0.50"	Keystone, 8833 (Snap On)

# DEMO MANUAL DC1498A

## SCHEMATIC DIAGRAMS

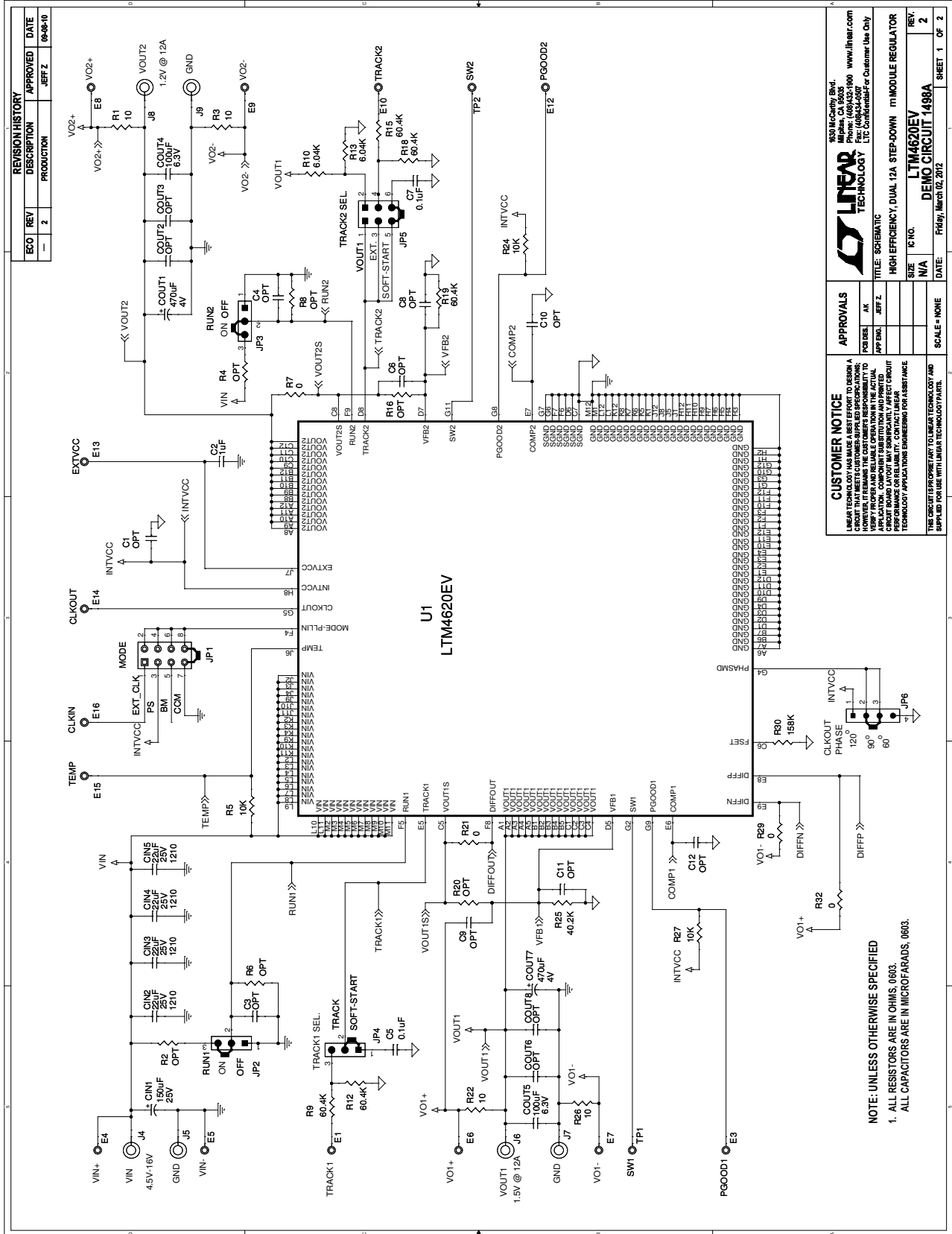

**CUSTOMER NOTICE**  
 LINAER TECHNOLOGY HAS DESIGNER A RESPONSIBILITY TO THE CUSTOMER TO DESIGN A CIRCUIT THAT MEETS CUSTOMER-SPECIFIED OPERATIONAL REQUIREMENTS. LINAER TECHNOLOGY IS NOT RESPONSIBLE FOR ANY DAMAGE TO THE CUSTOMER'S APPLICATION, COMPONENTS, SYSTEMS AND PRINTED CIRCUIT BOARD LAYOUT MAY OCCUR DUE TO THE APPLICATION OF THIS SCHEMATIC. LINAER TECHNOLOGY APPLICATION ENGINEERS FOR ASSISTANCE.

**APPROVALS**

DESIGNER	AK
APP ENGR	JEFF Z

**LINEAR TECHNOLOGY**  
 1630 McCarthy Blvd.  
 Milpitas, CA 95035  
 Phone: (408) 441-0000  
 Fax: (408) 441-0007  
 E-Mail: [info@linear.com](mailto:info@linear.com)  
[www.linear.com](http://www.linear.com)

TITLE: SCHEMATIC  
 HIGH EFFICIENCY, DUAL 12A STEP-DOWN IN-MODULE REGULATOR

SIZE: N/A  
 IC NO.: LTM4620EV  
 DEMO CIRCUIT 1498A

DATE: Friday, March 02, 2012

SCALE: NONE

REV. 2  
 SHEET 1 OF 2

NOTE: UNLESS OTHERWISE SPECIFIED  
 1. ALL RESISTORS ARE IN OHMS, 0603.  
 ALL CAPACITORS ARE IN MICROFARADS, 0603.



**SCHEMATIC DIAGRAMS**

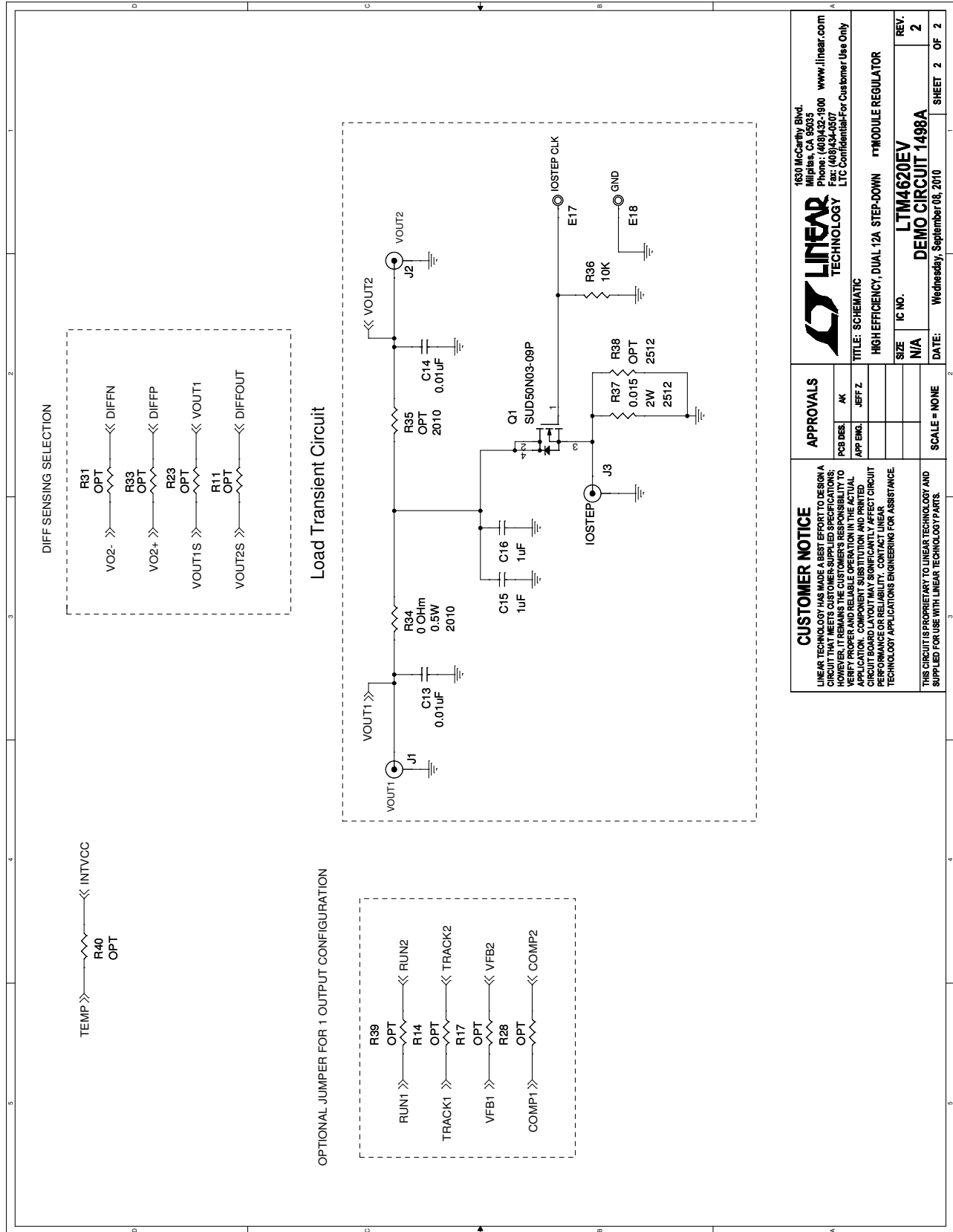

**LINEAR TECHNOLOGY**  
 1630 McCarthy Blvd  
 Milpitas, CA 95035  
 Phone: (408)432-1900 www.linear.com  
 Fax: (408)434-0507  
 LTC Confidential-For Customer Use Only

**APPROVALS**

PCB DES.	AK
APP ENG.	JEFF Z

**CUSTOMER NOTICE**  
 LINEAR TECHNOLOGY HAS MADE A BEST EFFORT TO DESIGN A CIRCUIT THAT MEETS CUSTOMER-SUPPLIED SPECIFICATIONS; HOWEVER, IT REMAINS THE CUSTOMER'S RESPONSIBILITY TO VERIFY PROPER AND RELIABLE OPERATION IN THE ACTUAL APPLICATION. CHANGES TO THE CUSTOMER-SUPPLIED CIRCUIT BOARD LAYOUT MAY SIGNIFICANTLY AFFECT CIRCUIT PERFORMANCE OR RELIABILITY. CONTACT LINEAR TECHNOLOGY APPLICATIONS ENGINEERING FOR ASSISTANCE.

**SCALE = NONE**

THIS CIRCUIT IS PROPRIETARY TO LINEAR TECHNOLOGY AND SUPPLIED FOR USE WITH LINEAR TECHNOLOGY PARTS.

**TITLE: SCHEMATIC**  
**HIGH EFFICIENCY, DUAL 12A STEP-DOWN MODULE REGULATOR**

**SIZE IC NO.**  
 N/A

**REV.**  
 2

**DATE:** Wednesday, September 03, 2010

**DEMO CIRCUIT 1498A**

**SHEET 2 OF 2**

# DEMO MANUAL DC1498A

---

## DEMONSTRATION BOARD IMPORTANT NOTICE

Linear Technology Corporation (LTC) provides the enclosed product(s) under the following **AS IS** conditions:

This demonstration board (DEMO BOARD) kit being sold or provided by Linear Technology is intended for use for **ENGINEERING DEVELOPMENT OR EVALUATION PURPOSES ONLY** and is not provided by LTC for commercial use. As such, the DEMO BOARD herein may not be complete in terms of required design-, marketing-, and/or manufacturing-related protective considerations, including but not limited to product safety measures typically found in finished commercial goods. As a prototype, this product does not fall within the scope of the European Union directive on electromagnetic compatibility and therefore may or may not meet the technical requirements of the directive, or other regulations.

If this evaluation kit does not meet the specifications recited in the DEMO BOARD manual the kit may be returned within 30 days from the date of delivery for a full refund. **THE FOREGOING WARRANTY IS THE EXCLUSIVE WARRANTY MADE BY THE SELLER TO BUYER AND IS IN LIEU OF ALL OTHER WARRANTIES, EXPRESSED, IMPLIED, OR STATUTORY, INCLUDING ANY WARRANTY OF MERCHANTABILITY OR FITNESS FOR ANY PARTICULAR PURPOSE. EXCEPT TO THE EXTENT OF THIS INDEMNITY, NEITHER PARTY SHALL BE LIABLE TO THE OTHER FOR ANY INDIRECT, SPECIAL, INCIDENTAL, OR CONSEQUENTIAL DAMAGES.**

The user assumes all responsibility and liability for proper and safe handling of the goods. Further, the user releases LTC from all claims arising from the handling or use of the goods. Due to the open construction of the product, it is the user's responsibility to take any and all appropriate precautions with regard to electrostatic discharge. Also be aware that the products herein may not be regulatory compliant or agency certified (FCC, UL, CE, etc.).

No License is granted under any patent right or other intellectual property whatsoever. **LTC assumes no liability for applications assistance, customer product design, software performance, or infringement of patents or any other intellectual property rights of any kind.**

LTC currently services a variety of customers for products around the world, and therefore this transaction **is not exclusive**.

**Please read the DEMO BOARD manual prior to handling the product.** Persons handling this product must have electronics training and observe good laboratory practice standards. **Common sense is encouraged.**

This notice contains important safety information about temperatures and voltages. For further safety concerns, please contact a LTC application engineer.

Mailing Address:

Linear Technology  
1630 McCarthy Blvd.  
Milpitas, CA 95035

Copyright © 2004, Linear Technology Corporation

Компания «Океан Электроники» предлагает заключение долгосрочных отношений при поставках импортных электронных компонентов на взаимовыгодных условиях!

Наши преимущества:

- Поставка оригинальных импортных электронных компонентов напрямую с производств Америки, Европы и Азии, а так же с крупнейших складов мира;
- Широкая линейка поставок активных и пассивных импортных электронных компонентов (более 30 млн. наименований);
- Поставка сложных, дефицитных, либо снятых с производства позиций;
- Оперативные сроки поставки под заказ (от 5 рабочих дней);
- Экспресс доставка в любую точку России;
- Помощь Конструкторского Отдела и консультации квалифицированных инженеров;
- Техническая поддержка проекта, помощь в подборе аналогов, поставка прототипов;
- Поставка электронных компонентов под контролем ВП;
- Система менеджмента качества сертифицирована по Международному стандарту ISO 9001;
- При необходимости вся продукция военного и аэрокосмического назначения проходит испытания и сертификацию в лаборатории (по согласованию с заказчиком);
- Поставка специализированных компонентов военного и аэрокосмического уровня качества (Xilinx, Altera, Analog Devices, Intersil, Interpoint, Microsemi, Actel, Aeroflex, Peregrine, VPT, Syfer, Eurofarad, Texas Instruments, MS Kennedy, Miteq, Cobham, E2V, MA-COM, Hittite, Mini-Circuits, General Dynamics и др.);

Компания «Океан Электроники» является официальным дистрибьютором и эксклюзивным представителем в России одного из крупнейших производителей разъемов военного и аэрокосмического назначения «**JONHON**», а так же официальным дистрибьютором и эксклюзивным представителем в России производителя высокотехнологичных и надежных решений для передачи СВЧ сигналов «**FORSTAR**».



## JONHON

«**JONHON**» (основан в 1970 г.)

Разъемы специального, военного и аэрокосмического назначения:

(Применяются в военной, авиационной, аэрокосмической, морской, железнодорожной, горно- и нефтедобывающей отраслях промышленности)

«**FORSTAR**» (основан в 1998 г.)

ВЧ соединители, коаксиальные кабели, кабельные сборки и микроволновые компоненты:

(Применяются в телекоммуникациях гражданского и специального назначения, в средствах связи, РЛС, а так же военной, авиационной и аэрокосмической отраслях промышленности).



Телефон: 8 (812) 309-75-97 (многоканальный)

Факс: 8 (812) 320-03-32

Электронная почта: [ocean@oceanchips.ru](mailto:ocean@oceanchips.ru)

Web: <http://oceanchips.ru/>

Адрес: 198099, г. Санкт-Петербург, ул. Калинина, д. 2, корп. 4, лит. А