

Accessories Index

• Cable	
T-Cable	21-1
Y-Cable	
.....	21-3
• Adaptor	
T-Adaptor	21-4
Y-Adaptor	
.....	21-6
I-Adaptor	21-7
• Cap	
Dust Cap	21-9
Waterproof Cap	
.....	21-11
Dummy	
.....	21-18
• Multi-port	
Multi-port	
.....	21-19
• Box	
Box	21-21
• Tool	
Wrench	
.....	21-22
Unlock Tool	
.....	21-22

Accessories - Cable

➤ T-Cable > Circular > Standard Size: 5/8"-27 UNS

■ Customized – Upon Request

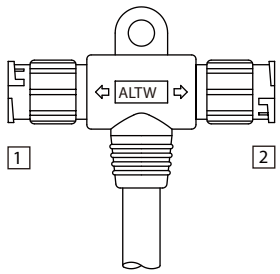

5 For connector 1
6 For connector 2

Choose Connector / Contacts Gender:
M: Male + Male
F: Female + Female
H: Male + Female
B: Female + Male

* Choose the cable length: 01-99 m / PVC UL2464 Cable

Current Rating	Contacts 2	Mating Style	Connector 1 (Male Connector / Male Contacts)	Connector 1 (Female Connector / Female Contacts)	More options
			Connector 2 (Male Connector / Male Contacts)	Connector 2 (Female Connector / Female Contacts)	
10A	02,03,04	Screw Thread	BA-2-2-00-MM0-TSA*	BA-2-2-00-FF0-TSA*	BA-2-2-00-5-6-0-TSA*
		2 point lock bayonet	BA-2-2-00-MM0-TLA*	BA-2-2-00-FF0-TLA*	BA-2-2-00-5-6-0-TLA*
5A	02,03,04,05,06,07,08	Screw Thread	BA-2-2-00-MM0-TSA*	BA-2-2-00-FF0-TSA*	BA-2-2-00-5-6-0-TSA*
		2 point lock bayonet	BA-2-2-00-MM0-TLA*	BA-2-2-00-FF0-TLA*	BA-2-2-00-5-6-0-TLA*
2A	10,12	Screw Thread	BA-2-2-00-MM0-TSA*	BA-2-2-00-FF0-TSA*	BA-2-2-00-5-6-0-TSA*
		2 point lock bayonet	BA-2-2-00-MM0-TLA*	BA-2-2-00-FF0-TLA*	BA-2-2-00-5-6-0-TLA*

➤ T-Cable > Circular > Other Size > Mix Size (10A+5A)

■ Customized – Upon Request

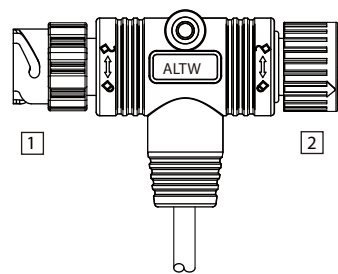

* Choose the cable length: 01-99 m / PVC UL2464 Cable

Current Rating	Contacts	Mating Style	Connector 1 (Male Connector / Male Contacts)	Connector 1 (Female Connector / Female Contacts)	Connector 1 (Male Connector / Male Contacts)
			Connector 2 (Male Connector / Male Contacts)	Connector 2 (Female Connector / Female Contacts)	Connector 2 (Female Connector / Female Contacts)
5A	08	Screw Thread	GA-080800-MM0-TSA*	GA-080800-FF0-TSA*	GA-080800-MF0-TSA*

➤ T-Cable > M Series Sensor > M12

■ Customized – Upon Request

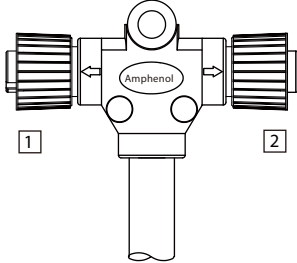

Choose Connector / Contacts Gender:

6 For connector 1
7 For connector 2

A/B/D Code
M: Male + Male
F: Female + Female

I Style
K: Connector (Male) + Contact (Male+Female)
Z: Connector (Female) + Contact (Male+Female)

* Choose the cable length: 01-99 m / PVC UL2464 Cable

Type	Current Rating	Contacts 2	Mating Style	Connector 1 (Male Connector / Male Contacts)	Connector 1 (Female Connector / Female Contacts)	More options	
				Connector 2 (Male Connector / Male Contacts)	Connector 2 (Female Connector / Female Contacts)		
M12	A Code	4A	03,04,05	Screw Thread	SS- 2 2 00-MM0-TSA*	SS- 2 2 00-FF0-TSA*	SS- 2 2 00- 6 7 0-TSA*
		2A	08		SS-080800-MM0-TSA*	SS-080800-FF0-TSA*	SS-080800- 6 7 0-TSA*
	B Code	4A	04,05		SB- 2 2 00-MM0-TSA*	SB- 2 2 00-FF0-TSA*	SB- 2 2 00- 6 7 0-TSA*
	D Code	4A	04,05		SD- 2 2 00-MM0-TSA*	SD- 2 2 00-FF0-TSA*	SD- 2 2 00- 6 7 0-TSA*
	I Style	4A	05		SI-050500-KK0-TSA*	SI-050500-ZZ0-TSA*	SI-050500- 6 7 0-TSA*
M12 (Plastic)	A Code	4A	03,04,05	Screw Thread	PS- 2 2 00-MM0-TSA*	PS- 2 2 00-FF0-TSA*	PS- 2 2 00- 6 7 0-TSA*
		2A	08		PS-080800-MM0-TSA*	PS-080800-FF0-TSA*	PS-080800- 6 7 0-TSA*
	B Code	4A	04,05		PB- 2 2 00-MM0-TSA*	PB- 2 2 00-FF0-TSA*	PB- 2 2 00- 6 7 0-TSA*
	D Code	4A	04,05		PD- 2 2 00-MM0-TSA*	PD- 2 2 00-FF0-TSA*	PD- 2 2 00- 6 7 0-TSA*
	I Style	4A	05		PI-050500-KK0-TSA*	PI-050500-ZZ0-TSA*	PI-050500- 6 7 0-TSA*

* Design and specification are subject to change without notice.

Y-Cable > M Series Sensor > M12

■ Customized – Upon Request

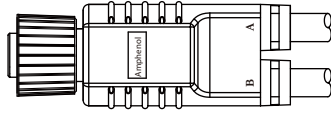

* Choose the cable length:01-99 m / PU VW-1Cable

Type		Current Rating	Contacts ②	Mating Style	Connector (Male Connector / Male Contacts)	Connector (Female Connector / Female Contacts)
M12	A Code	4A	03,04,05	Screw Thread	SS- ② 0000-M00-YSB*	SS- ② 0000-F00-YSB*
		2A	08	Screw Thread	SS-080000-M00-YSB*	SS-080000-F00-YSB*
	B Code	4A	04,05	Screw Thread	SB- ② 0000-M00-YSB*	SB- ② 0000-F00-YSB*
	D Code	4A	04,05	Screw Thread	SD- ② 0000-M00-YSB*	SD- ② 0000-F00-YSB*
	I Style	4A	05	Screw Thread	SI-050000-K00-YSB*	SI-050000-Z00-YSB*

Accessories - Adaptor

↳ T-Adaptor > Circular > Mini Size: 7/16"-28 UNS

■ Customized – Upon Request

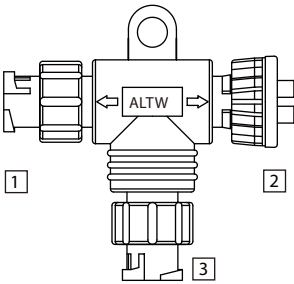

5 For connector 1
6 For connector 2
7 For connector 3

Choose Connector / Contacts Gender:
M: Male + Male
F: Female + Female

Current Rating	Contacts 2	Mating Style	Connector 1 (Male Connector / Male Contacts)	Connector 1 (Female Connector / Female Contacts)	More options
			Connector 2 (Male Connector / Male Contacts)	Connector 2 (Female Connector / Female Contacts)	
			Connector 3 (Male Connector / Male Contacts)	Connector 3 (Female Connector / Female Contacts)	
5A	02,03	Screw Thread	AA-2 2 2 -MMM-TS001	AA-2 2 2 -FFF-TS001	AA-2 2 2 -5 6 7 -TS001
		2 point lock bayonet	AA-2 2 2 -MMM-TL001	AA-2 2 2 -FFF-TL001	AA-2 2 2 -5 6 7 -TL001
2A	04,05,06	Screw Thread	AA-2 2 2 -MMM-TS001	AA-2 2 2 -FFF-TS001	AA-2 2 2 -5 6 7 -TS001
		2 point lock bayonet	AA-2 2 2 -MMM-TL001	AA-2 2 2 -FFF-TL001	AA-2 2 2 -5 6 7 -TL001

↳ T-Adaptor > Circular > Standard Size: 5/8"-27 UNS

■ Customized – Upon Request

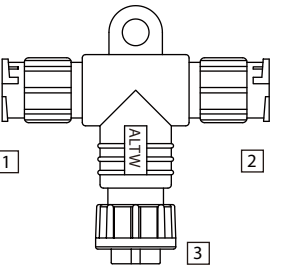

5 For connector 1
6 For connector 2
7 For connector 3

Choose Connector / Contacts Gender:
M: Male + Male
F: Female + Female
H: Male + Female
B: Female + Male

* Choose the cable length:01-99 m /
PVC UL2464 Cable

Current Rating	Contacts 2	Mating Style	Connector 1 (Male Connector / Male Contacts)	Connector 1 (Female Connector / Female Contacts)	More options
			Connector 2 (Male Connector / Male Contacts)	Connector 2 (Female Connector / Female Contacts)	
			Connector 3 (Male Connector / Male Contacts)	Connector 3 (Female Connector / Female Contacts)	
5A	02,03,04, 05,06,07, 08	Screw Thread	BA-2 2 2 -MMM-TS001	BA-2 2 2 -FFF-TS001	BA-2 2 2 -5 6 7 -TS001
		2 point lock bayonet	BA-2 2 2 -MMM-TL001	BA-2 2 2 -FFF-TL001	BA-2 2 2 -5 6 7 -TL001
2A	10,12	Screw Thread	BA-2 2 2 -MMM-TS001	BA-2 2 2 -FFF-TS001	BA-2 2 2 -5 6 7 -TS001
		2 point lock bayonet	BA-2 2 2 -MMM-TL001	BA-2 2 2 -FFF-TL001	BA-2 2 2 -5 6 7 -TL001

* Design and specification are subject to change without notice.

↳ T-Adaptor > M Series Sensor > M12

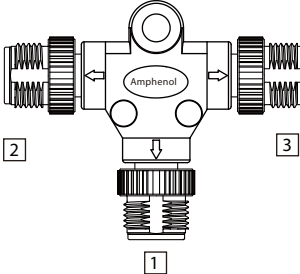
		Customized – Upon Request				Choose Connector / Contacts Gender: 5 For connector 1 6 For connector 2 7 For connector 3 <u>A/B/D Code</u> M: Male + Male F: Female + Female <u>I Style</u> K: Connector (Male) + Contact (Male+Female) Z: Connector (Female) + Contact (Male+Female)	
Type	Current Rating	Contacts 2	Mating Style	Connector 1 (Male Connector / Male Contacts)	Connector 1 (Female Connector / Female Contacts)	More options	
				Connector 2 (Male Connector / Male Contacts)	Connector 2 (Female Connector / Female Contacts)		
				Connector 3 (Male Connector / Male Contacts)	Connector 3 (Female Connector / Female Contacts)		
M12	A Code	4A	03,04,05	Screw Thread	SS- 2 2 2 -MMM-TS001	SS- 2 2 2 -FFF-TS001	SS- 2 2 2 -5 6 7-TS001
		2A	08	Screw Thread	SS-080808-MMM-TS001	SS-080808-FFF-TS001	SS-080808- 5 6 7-TS001
	B Code	4A	04,05	Screw Thread	SB- 2 2 2 -MMM-TS001	SB- 2 2 2 -FFF-TS001	SB- 2 2 2 -5 6 7-TS001
	D Code	4A	04,05	Screw Thread	SD- 2 2 2 -MMM-TS001	SD- 2 2 2 -FFF-TS001	SD- 2 2 2 -5 6 7-TS001
	I Style	4A	05	Screw Thread	SI-050505-KKK-TS001	SI-050505-ZZZ-TS001	SI-050505- 5 6 7-TS001
M12 (Plastic)	A Code	4A	03,04,05	Screw Thread	PS- 2 2 2 -MMM-TS001	PS- 2 2 2 -FFF-TS001	PS- 2 2 2 -5 6 7-TS001
		2A	08	Screw Thread	PS-080808-MMM-TS001	PS-080808-FFF-TS001	PS-080808- 5 6 7-TS001
	B Code	4A	04,05	Screw Thread	PB- 2 2 2 -MMM-TS001	PB- 2 2 2 -FFF-TS001	PB- 2 2 2 -5 6 7-TS001
	D Code	4A	04,05	Screw Thread	PD- 2 2 2 -MMM-TS001	PD- 2 2 2 -FFF-TS001	PD- 2 2 2 -5 6 7-TS001
	I Style	4A	05	Screw Thread	PI-050505-KKK-TS001	PI-050505-ZZZ-TS001	PI-050505- 5 6 7-TS001

Y-Adaptor > M Series Sensor > M12

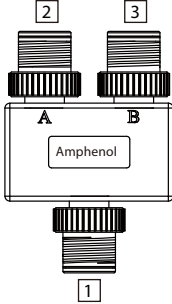
		Customized – Upon Request				Choose Connector / Contacts Gender:	
Type	Current Rating	Contacts 2	Mating Style	Connector 1 (Male Connector / Male Contacts)	Connector 1 (Female Connector / Female Contacts)	More options	
				Connector 2 (Male Connector / Male Contacts)	Connector 2 (Female Connector / Female Contacts)		
				Connector 3 (Male Connector / Male Contacts)	Connector 3 (Female Connector / Female Contacts)		
M12	A Code	4A	03,04,05	Screw Thread	SS-222-MMM-YS001	SS-222-FFF-YS001	SS-222-567-YS001
		2A	08	Screw Thread	SS-080808-MMM-YS001	SS-080808-FFF-YS001	SS-080808-567-YS001
	B Code	4A	04,05	Screw Thread	SB-222-MMM-YS001	SB-222-FFF-YS001	SB-222-567-YS001
	D Code	4A	04,05	Screw Thread	SD-222-MMM-YS001	SD-222-FFF-YS001	SD-222-567-YS001
	I Style	4A	05	Screw Thread	SI-050505-KKK-YS001	SI-050505-ZZZ-YS001	SI-050505-567-YS001
M12 (Plastic)	A Code	4A	03,04,05	Screw Thread	PS-222-MMM-YS001	PS-222-FFF-YS001	PS-222-567-YS001
		2A	08	Screw Thread	PS-080808-MMM-YS001	PS-080808-FFF-YS001	PS-080808-567-YS001
	B Code	4A	04,05	Screw Thread	PB-222-MMM-YS001	PB-222-FFF-YS001	PB-222-567-YS001
	D Code	4A	04,05	Screw Thread	PD-222-MMM-YS001	PD-222-FFF-YS001	PD-222-567-YS001
	I Style	4A	05	Screw Thread	PI-050505-KKK-YS001	PI-050505-ZZZ-YS001	PI-050505-567-YS001

* Design and specification are subject to change without notice.

∨ I-Adaptor > Circular > Mini Size: 7/16"-28 UNS

■ Customized – Upon Request

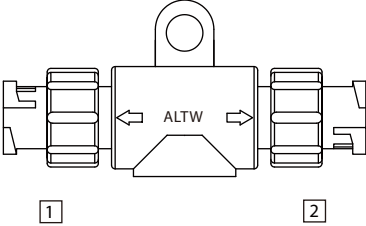

6 For connector 1
7 For connector 2

Choose Connector / Contacts Gender:
M: Male + Male
F: Female + Female

Current Rating	Contacts ③	Mating Style	Connector 1 (Male Connector / Male Contacts)	Connector 1 (Female Connector / Female Contacts)	More options
			Connector 2 (Male Connector / Male Contacts)	Connector 2 (Female Connector / Female Contacts)	
5A	02,03	Screw Thread	AA-00 ③ ③ -0MM-IS001	AA-00 ③ ③ -0FF-IS001	AA-00 ③ ③ -0 ⑥ ⑦ IS001
		2 point lock bayonet	AA-00 ③ ③ -0MM-IL001	AA-00 ③ ③ -0FF-IL001	AA-00 ③ ③ -0 ⑥ ⑦ IL001
2A	04,05,06	Screw Thread	AA-00 ③ ③ -0MM-IS001	AA-00 ③ ③ -0FF-IS001	AA-00 ③ ③ -0 ⑥ ⑦ IS001
		2 point lock bayonet	AA-00 ③ ③ -0MM-IL001	AA-00 ③ ③ -0FF-IL001	AA-00 ③ ③ -0 ⑥ ⑦ IL001

∨ I-Adaptor > Circular > Standard Size: 5/8"-27 UNS

■ Customized – Upon Request

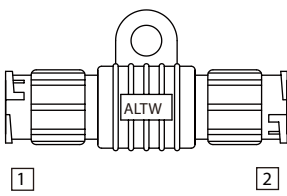

6 For connector 1
7 For connector 2

Choose Connector / Contacts Gender:
M: Male + Male
F: Female + Female
H: Male + Female
B: Female + Male

Current Rating	Contacts ③	Mating Style	Connector 1 (Male Connector / Male Contacts)	Connector 1 (Female Connector / Female Contacts)	More options
			Connector 2 (Male Connector / Male Contacts)	Connector 2 (Female Connector / Female Contacts)	
5A	02,03,04, 05,06,07, 08	Screw Thread	BA-00 ③ ③ -0MM-IS001	BA-00 ③ ③ -0FF-IS001	BA-00 ③ ③ -0 ⑥ ⑦ -IS001
		2 point lock bayonet	BA-00 ③ ③ -0MM-IL001	BA-00 ③ ③ -0FF-IL001	BA-00 ③ ③ -0 ⑥ ⑦ -IL001
2A	10,12	Screw Thread	BA-00 ③ ③ -0MM-IS001	BA-00 ③ ③ -0FF-IS001	BA-00 ③ ③ -0 ⑥ ⑦ -IS001
		2 point lock bayonet	BA-00 ③ ③ -0MM-IL001	BA-00 ③ ③ -0FF-IL001	BA-00 ③ ③ -0 ⑥ ⑦ -IL001

└ I-Adaptor > Circular > Other Size > Mix Size (10A+5A)

■ Customized – Upon Request

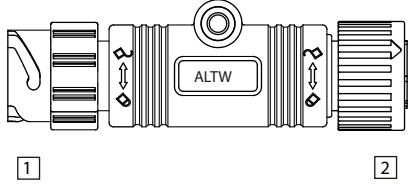

Current Rating	Contacts	Mating Style	Connector 1 (Male Connector / Male Contacts)	Connector 1 (Female Connector / Female Contacts)	Connector 1 (Female Connector / Female Contacts)
			Connector 2 (Male Connector / Male Contacts)	Connector 2 (Female Connector / Female Contacts)	Connector 1 (Male Connector / Male Contacts)
5A	08	3 point lock bayonet	GA-000808-0MM-IT001	GA-000808-OFF-IT001	GA-000808-0FM-IT001

└ I-Adaptor > M Series Sensor > M12

■ Customized – Upon Request

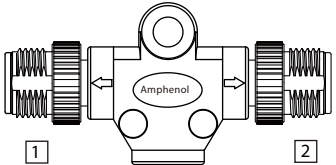

Choose Connector / Contacts Gender:

- 6 For connector 1
- 7 For connector 2

A/B/D Code
M: Male + Male
F: Female + Female
I Style
K: Connector (Male) + Contact (Male+Female)
Z: Connector (Female) + Contact (Male+Female)

Type	Current Rating	Contacts 3	Mating Style	Connector 1 (Male Connector / Male Contacts)	Connector 1 (Female Connector / Female Contacts)	More options	
				Connector 2 (Male Connector / Male Contacts)	Connector 2 (Female Connector / Female Contacts)		
M12	A Code	4A	03,04,05	Screw Thread	SS-00 3 3 -0MM-IS001	SS-00 3 3 -OFF-IS001	SS-00 3 3 -0 6 7 IS001
		2A	08	Screw Thread	SS-000808-0MM-IS001	SS-000808-OFF-IS001	SS-000808-0 6 7 IS001
	B Code	4A	04,05	Screw Thread	SB-00 3 3 -0MM-IS001	SB-00 3 3 -OFF-IS001	SB-00 3 3 -0 6 7 IS001
	D Code	4A	04,05	Screw Thread	SD-00 3 3 -0MM-IS001	SD-00 3 3 -OFF-IS001	SD-00 3 3 -0 6 7 IS001
	I Style	4A	05	Screw Thread	SI-000505-0KK-IS001	SI-000505-0ZZ-IS001	SI-000505-0KZ-IS001 SI-000505-0ZK-IS001
M12 (Plastic)	A Code	4A	03,04,05	Screw Thread	PS-00 3 3 -0MM-IS001	PS-00 3 3 -OFF-IS001	PS-00 3 3 -0 6 7 IS001
		2A	08	Screw Thread	PS-000808-0MM-IS001	PS-000808-OFF-IS001	PS-000808-0 6 7 IS001
	B Code	4A	04,05	Screw Thread	PB-00 3 3 -0MM-IS001	PB-00 3 3 -OFF-IS001	PB-00 3 3 -0 6 7 IS001
	D Code	4A	04,05	Screw Thread	PD-00 3 3 -0MM-IS001	PD-00 3 3 -OFF-IS001	PD-00 3 3 -0 6 7 IS001
	I Style	4A	05	Screw Thread	PI-000505-0KK-IS001	PI-000505-0ZZ-IS001	PI-000505-0KZ-IS001 PI-000505-0ZK-IS001

* Design and specification are subject to change without notice.

Accessories - Cap

∟ Dust Cap > Circular

■ Customized – Upon Request

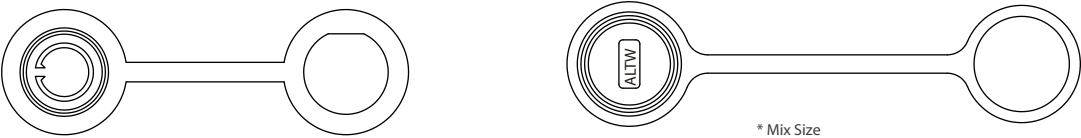

* Mini Size | Standard Size | Middle Size | Large Size
* With Rubber Lead

* Mix Size
* With Rubber Lead

Size	Mating Pair	Mating Pair (Gender)	P/N
Mini Size 7/16"-28 UNS	Receptacle	Male	CAP-DAAMDPC1
Standard Size 5/8"-27 UNS	Receptacle	Male	CAP-DABMDPC1 CAP-DABMDPC2 CAP-DABMDPC3
		Female	-
	Overmolded with Cable	Male	CAP-DABMDCC1 CAP-DABMDCC2
		Female	CAP-DABFDCC1
Middle Size 13/16"-28 UNS	Receptacle	Male	CAP-DACMDPC1 CAP-DACMDPC2
	Overmolded with Cable	Female	CAP-DACFDCC1
Large Size 1"-20 UNEF	Receptacle	Male	CAP-DADMDPC1
Mix Size 12-5A	Receptacle	Male	CAP-DPLMDPC1

▾ Dust Cap > D-SUB > Standard & High Density

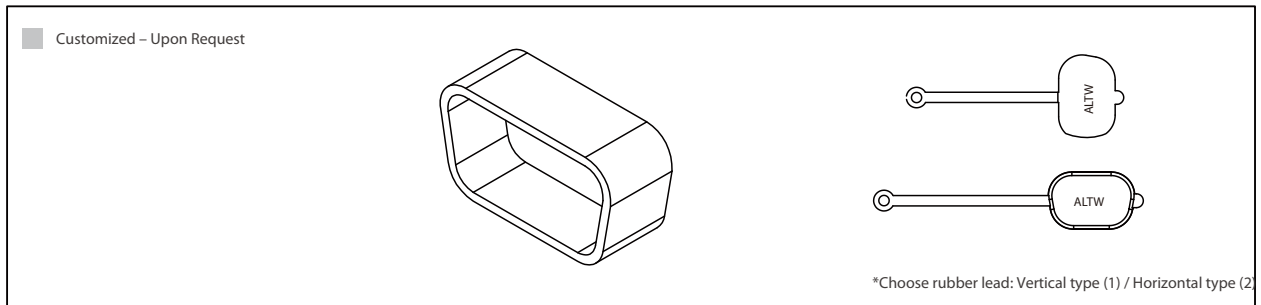

Type		Mating Pairs	Mating Pair (Gender)	P/N
Standard D-SUB	High Density D-SUB			
Standard (9 pins)	High Density (15 Pins)	Receptacle (With horizontal rubber lead)	Male	CAP-DD1MDPC2
		Receptacle and Overmolded with Cable (With horizontal / Vertical rubber lead)		CAP-DD1MDMA1
		Receptacle	Female	CAP-DD1FDPC1* CAP-DD1FDPC2*
		Receptacle and Overmolded with Cable		CAP-DD1FDMA1
Standard (15 pins)	High Density (26 Pins)	Receptacle and Overmolded with Cable	Male	CAP-DD2MDMA1
		Receptacle and Overmolded with Cable	Female	CAP-DD2FDMA1
Standard (25 pins)	High Density (44 Pins)	Receptacle and Overmolded with Cable	Male	CAP-DD3MDMA1
		Receptacle (With horizontal rubber lead)	Female	CAP-DD3FDPC1
		Receptacle and Overmolded with Cable		CAP-DD3FDMA1

* Design and specification are subject to change without notice.

Waterproof Cap > Circular

Customized – Upon Request

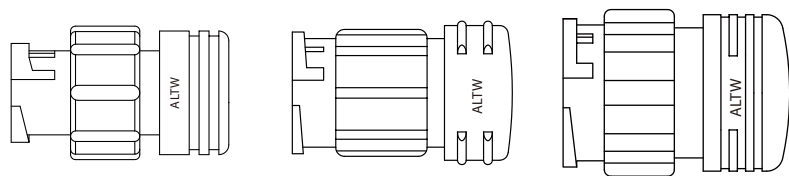

Choose Connector / Contacts Gender:

- 6 More to choose: None(A) / With Chain(B) / With Rubber Lead(C) / With Fish Line(D)
- 7 * Mini Size: Choose 2 contacts(1) / 3 contacts(3) / 4~6 contacts(2) for male mating pair
- * Standard Size: Choose 12 contacts (2) for male mating pair
- * Middle Size: Choose plastic(1) or metal(2) items

Size	Mating Pair	Mating Style	Mating Pair (Gender)	P/N	
Mini Size 7/16"-28 UNS	Receptacle	Screw Thread	Male	CAP-WAAMSP ⁶ 1	
		2 point lock bayonet	Male	CAP-WAAML ⁶ 7	
			Female	CAP-WAAFLP ⁶ 7	
	Overmolded with Cable	Screw Thread	Male	CAP-WAAMSMA1	
		2 point lock bayonet	Male	CAP-WAAMLMA ⁷	
			Female	CAP-WAFLMA ⁷	
	Receptacle and Overmolded with Cable	Screw Thread	Male	CAP-WAAMSMA1	
		2 point lock bayonet	Male	CAP-WAAMLMA ⁷	
			Female	CAP-WAFLMA ⁷	
	Standard Size 5/8"-27 UNS	Receptacle	Screw Thread	Male	CAP-WABMSP ⁶ 1
			2 point lock bayonet	Female	CAP-WABFSP ⁶ 1
				Male	CAP-WABMLP ⁶ 7
Overmolded with Cable		2 point lock bayonet	Female	CAP-WABFLP ⁶ 7	
			Male	CAP-WABMSMA1	
		Screw Thread	Female	CAP-WABFSMA1	
Receptacle and Overmolded with Cable		2 point lock bayonet	Male	CAP-WABMLMA ⁷	
			Female	CAP-WABFLMA ⁷	
		Screw Thread	Male	CAP-WABMSMA1	
Middle Size 13/16"-28 UNS		Receptacle	Screw Thread	Female	CAP-WABFSMA1
			2 point lock bayonet	Male	CAP-WACMSP ⁶ 7
				Female	CAP-WACFLP ⁶ 1
Overmolded with Cable	Screw Thread	Male	CAP-WACMLP ⁶ 1		
	2 point lock bayonet	Male	CAP-WACMSMA ⁷		
		Female	CAP-WACMLMA1		
Receptacle and Overmolded with Cable	2 point lock bayonet	Female	CAP-WACFLMA1		
		Screw Thread	Male	CAP-WACMSMA ⁷	
	Screw Thread	Male	CAP-WACMLMA1		
	2 point lock bayonet	Female	CAP-WACFLMA1		

Waterproof Cap >Circular

■ Customized – Upon Request

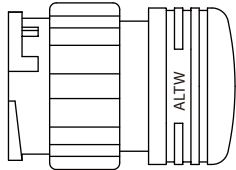

* Large Size

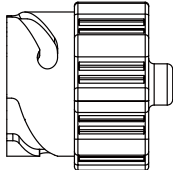

* Mix Size

⑥ More to choose: None(A) / With Chain(B) / With Rubber Lead(C) / With Fish Line(D)

⑦ * Large Size: Choose 18 contacts(2) for female mating pair

Size	Mating Pair	Mating Style	Mating Pair (Gender)	P/N
Large Size 1"-20 UNEF	Receptacle	Screw Thread	Male	CAP-WADMSP ⑥ 1
		2 point lock bayonet	Male	CAP-WADMLP ⑥ ⑦
	Female		CAP-WADFLP ⑥ ⑦	
	Overmolded with Cable	Screw Thread	-	-
		2 point lock bayonet	-	-
	Receptacle and Overmolded with Cable	Screw Thread	Male	CAP-WADMSMA1
			Female	CAP-WADFLMA ⑦
		2 point lock bayonet	Male	CAP-WADMLMA ⑦
Mix Size (Between Standard & Middle Size)	Receptacle	3 Points Lock	Male	CAP-WEBMLP ⑥ 1
			Female	CAP-WEBFLP ⑥ 1
	Receptacle and Overmolded with Cable	3 Points Lock	Male	CAP-WEBMLMA1
			Female	CAP-WEBFLMA1

* Design and specification are subject to change without notice.

Waterproof Cap > Power

Customized – Upon Request

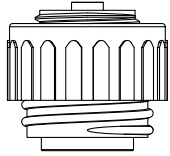

* 8A (PWE) | 12A (PWF) | 16A (PWG)

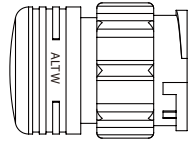

* 20A (PWC) | 20A+2A (PWCU)

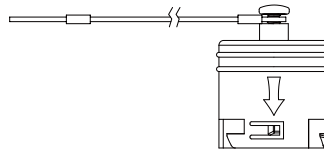

* 25A (PWH) | 30A (PWJ)

6 More to choose: None(A) / With Chain(B) / With Rubber Lead(C) / With Fish Line(D)

Current Rating	Mating Pair	Mating Style	Mating Pair (Gender)	P/N
8A(PWE)	Receptacle	Screw Thread	Male	CAP-WTAMSP 6 1
	Receptacle and Overmolded with Cable		Female	CAP-WTAFSP 6 1
			Male	CAP-WTAM SMA1
			Female	CAP-WTAF SMA1
12A(PWF)	Receptacle	Screw Thread	Male	CAP-WTAMSP 6 1
	Receptacle and Overmolded with Cable		Female	CAP-WTAFSP 6 1
			Male	CAP-WTAM SMA1
			Female	CAP-WTAF SMA1
16A(PWG)	Receptacle	Screw Thread	Male	CAP-WTAMSP 6 1
	Receptacle and Overmolded with Cable		Female	CAP-WTAFSP 6 1
			Male	CAP-WTAM SMA1
			Female	CAP-WTAF SMA1
20A(PWC)	Receptacle	2 point lock bayonet	Male	CAP-WACMLP 6 1
	Receptacle and Overmolded with Cable		Female	CAP-WACFLMA2
	Receptacle and Overmolded with Cable		Male	CAP-WACMLMA1
20A+2A(PWCU)	Receptacle	2 point lock bayonet	Male	CAP-WACMLP 6 1
	Receptacle and Overmolded with Cable		Female	CAP-WACFLMA2
	Receptacle and Overmolded with Cable		Male	CAP-WACMLMA1
25A(PWH)	Receptacle and Overmolded with Cable	3 point lock bayonet	Female	CAP-WPWFTMD1
30A(PWJ)	Receptacle and Overmolded with Cable	3 point lock bayonet	Male	CAP-WPWTMD1

Waterproof Cap > Sensor > M8

Customized – Upon Request

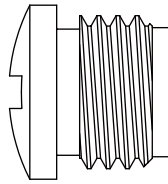

For Female

Size	Mating Pair	Mating Style	Mating Pair (Gender)	P/N
M8	Overmolded with Cable	Screw Thread	Female	CAP-WBBFSCC1
	Receptacle and Overmolded with Cable	Screw Thread	Male	CAP-WBBMSMA1
			Female	CAP-WBBFSMA1

Waterproof Cap > Sensor > M10.5

Customized – Upon Request

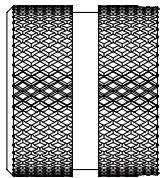

For male

Size	Mating Pair	Mating Style	Mating Pair (Gender)	P/N
M10.5	Receptacle and Overmolded with Cable	Screw Thread	Male	CAP-WBCMSMA2

* Design and specification are subject to change without notice.

Waterproof Cap > Sensor > M12

Customized – Upon Request

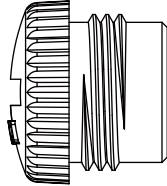

* For Female

7 Choose plastic(1) or metal(2) items

Size	Size	Mating Pair	Mating Style	Mating Pair (Gender)	P/N
M12	A/B/D Code I Style	Receptacle	Screw Thread	Male	CAP-WBDPMSB1
		Receptacle and Overmolded with Cable	Screw Thread	Male	CAP-WBDMSMA 7
M12(Plastic)	A/B/D Code I Style	Receptacle and Overmolded with Cable	Screw Thread	Female	CAP-WBDFSMA 7
				Male	CAP-WBDMSMA 7
				Female	CAP-WBDFSMA 7

Waterproof Cap > Sensor > Heavy Duty Shielded Connectors

Customized – Upon Request

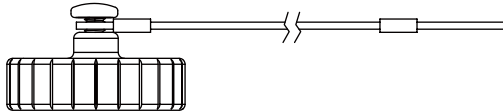

Size	Mating Pair	Mating Style	Mating Pair (Gender)	P/N
M22	Receptacle	Screw Thread	Male	CAP-WHBMSPD1

Waterproof Cap > Sensor > M23

Customized – Upon Request

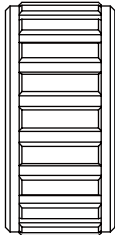

Size	Mating Pair	Mating Style	Mating Pair (Gender)	P/N
M23	Receptacle and Overmolded with Cable	Screw Thread	Male	CAP-WBHMSMA1

Waterproof Cap > USB | IEEE 1394

■ Customized – Upon Request

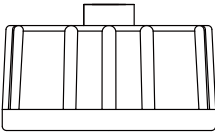

* USB Screw (Mating Pair: Male)

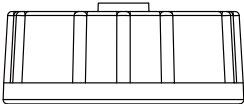

* USB Lock



* USB Screw (Mating Pair: Female)

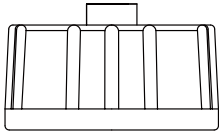

* IEEE 1394

⑥ More to choose: None(A) / With Chain(B) / With Rubber Lead(C) / With Fish Line(D)

Type	Mating Pair	Mating Style	Mating Pair (Gender)	P/N
USB 2.0 Type A USB 2.0 Type B USB 3.0 Type A	Receptacle	Screw Thread	Male	CAP-WACMSP ⑥ 1
		2 point lock bayonet	Male	CAP-WADMLP ⑥ 1
	Receptacle and Overmolded with Cable	Screw Thread	Male	CAP-WACMSMA1
		2 point lock bayonet	Male	CAP-WADMLMA1
	Overmolded with Cable	Screw Thread	Female	CAP-WUSFSCC1
IEEE 1394	Receptacle	Screw Thread	Male	CAP-WACMSP ⑥ 1
	Receptacle and Overmolded with Cable	Screw Thread	Male	CAP-WACMSMA1

Waterproof Cap > D-SUB | DVI

■ Customized – Upon Request

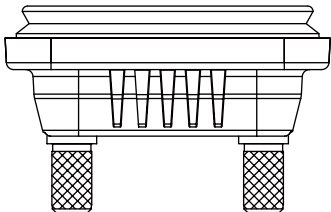

⑦ Choose rubber lead: Vertical type (1) / Horizontal type (2)

Type		Mating Pairs	Mating Style	Mating Pair (Gender)	P/N
Standard D-SUB	High Density D-SUB				
Standard (9 pins)	High Density (15 Pins)	Receptacle	Screw Thread	Male & Female	CAP-WD1CSPA1
Standard (15 pins)	High Density (26 Pins)	Receptacle	Screw Thread	Male & Female	CAP-WD2CSPA1
Standard (25 pins)	High Density (44 Pins)	Receptacle	Screw Thread	Male & Female	CAP-WD3CSPA1
DVI		Receptacle	Screw Thread	Male & Female	CAP-WDVCSPA1

* Design and specification are subject to change without notice.

Waterproof Cap > RJ

■ Customized – Upon Request

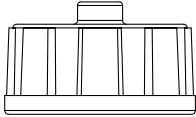

* RJ C 3 Point Lock

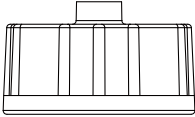

* RJ C Screw

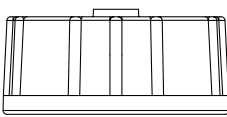

* RJ D Screw

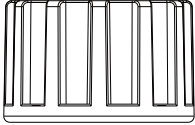

* RJ ODVA 3 Point Lock

6 More to choose: None(A) / With Chain(B) / With Rubber Lead(C) / With Fish Line(D)
7 Choose plastic (1) or metal (2) items

Size	Mating Pair	Mating Style	Mating Pair (Gender)	P/N
C Size	Receptacle	3 point lock bayonet	Male	CAP-WACMTMA1 CAP-WACMTP 6 1
		Screw Thread	Male	CAP-WACMSMA 7 CAP-WACMSP 6 7
D Size	Receptacle	Screw Thread	Male	CAP-WADMSMA1 CAP-WADMSP 6 1
ODVA	Receptacle	3 point lock bayonet	Male	CAP-WEOFTPC1

Waterproof Cap > HDMI

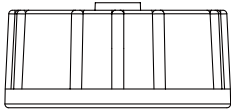

* D Size (Circular Type)

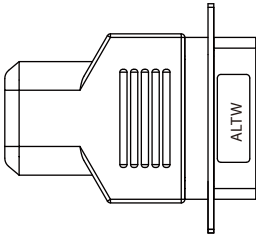

* Rectangle Type

Size	Mating Pair	Mating Style	Mating Pair (Gender)	P/N
D Size (Circular Type)	Receptacle	Screw Thread	Male	CAP-WADMSMA1
Rectangle Type	Receptacle	Latch Type	Female	CAP-WHDFLPA1

Waterproof Cap > Fiber Optic

■ Customized – Upon Request

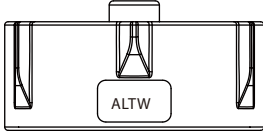

7

Size	Mating Pair	Mating Style	Mating Pair (Gender)	P/N
Fiber Optic	Receptacle and Overmolded with Cable	3 point lock bayonet	Female	CAP-WFBFTMA1

Dummy > Circular > Middle Size: 13/16"-28 UNS

■ Customized – Upon Request

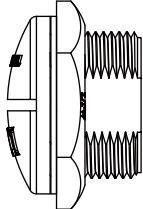

Size	Mating Pair	Mating Style	P/N
13/16"-28 UNS	Receptacle (Female)	Screw Thread	CAP-CACFSBA1

* Design and specification are subject to change without notice.

Accessories - Multi-port

Multi-port > Circular > Mini Size: 7/16"-28 UNS

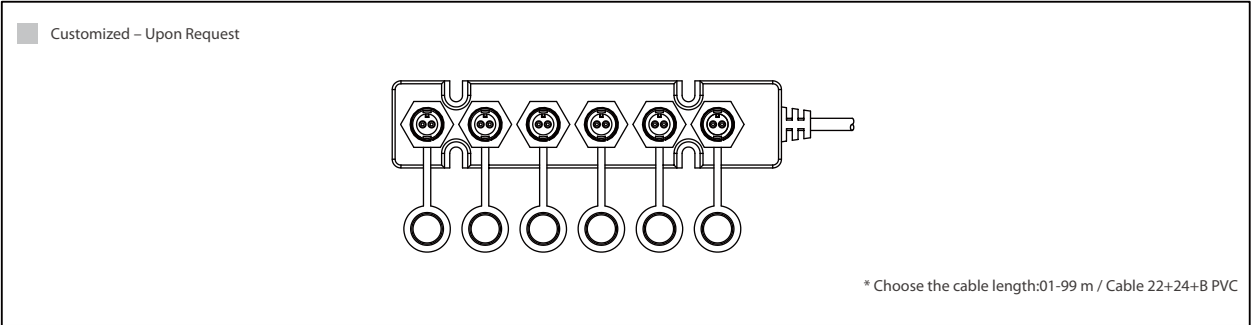

Current Rating	Contacts 2	Mating Style	Connector 1 (Male Connector / Male Contacts)	Connector 1 (Male Connector / Female Contacts)	More options
			Connector 2 (Male Connector / Male Contacts)	Connector 2 (Male Connector / Female Contacts)	
			Connector 3 (Male Connector / Male Contacts)	Connector 3 (Male Connector / Female Contacts)	
			Connector 4 (Male Connector / Male Contacts)	Connector 4 (Male Connector / Female Contacts)	
			Connector 5 (Male Connector / Male Contacts)	Connector 5 (Male Connector / Female Contacts)	
			Connector 6 (Male Connector / Male Contacts)	Connector 6 (Male Connector / Female Contacts)	
5A	02,03	Screw Thread	A-2 2 2 2 2 2 -MMMMMM-SA*	A-2 2 2 2 2 2 -HHHHHH-SA*	A-2 2 2 2 2 -7 8 9 10 11 12 13 -SA*
		2 point lock bayonet	A-2 2 2 2 2 2 -MMMMMM-LA* A-22222-MMMMMM-LA01	A-2 2 2 2 2 2 -HHHHHH-LA*	A-2 2 2 2 2 -7 8 9 10 11 12 13 -LA*
2A	04,05,06	Screw Thread	A-2 2 2 2 2 2 -MMMMMM-SA*	A-2 2 2 2 2 2 -HHHHHH-SA*	A-2 2 2 2 2 -7 8 9 10 11 12 13 -SA*
		2 point lock bayonet	A-2 2 2 2 2 2 -MMMMMM-LA*	A-2 2 2 2 2 2 -HHHHHH-LA*	A-2 2 2 2 2 -7 8 9 10 11 12 13 -LA*

Multi-port > Circular > Standard Size: 5/8"-27 UNS

Customized – Upon Request

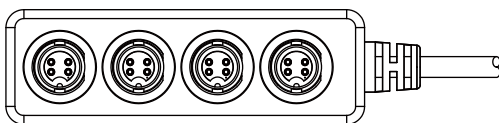

- 6 For connector 1
- 7 For connector 2
- 8 For connector 3
- 9 For connector 4

Choose Connector / Contacts Gender:

- M: Male + Male
- F: Female + Female

* Choose the cable length: 01-99 m / Cable 22+24+B PVC

Current Rating	Contacts 2	Mating Style	Connector 1 (Male Connector / Male Contacts)	Connector 1 (Male Connector / Female Contacts)	More options
			Connector 2 (Male Connector / Male Contacts)	Connector 2 (Male Connector / Female Contacts)	
			Connector 3 (Male Connector / Male Contacts)	Connector 3 (Male Connector / Female Contacts)	
			Connector 4 (Male Connector / Male Contacts)	Connector 4 (Male Connector / Female Contacts)	
10A	02,03,04	Screw Thread	B-2 2 2 2 -MMMMMM-SA*	B-2 2 2 2 -HHHHHH-SA*	B-2 2 2 2 -6 7 8 9 -SA*
		2 point lock bayonet	B-2 2 2 2 -MMMMMM-LA*	B-2 2 2 2 -HHHHHH-LA*	B-2 2 2 2 -6 7 8 9 -LA*
5A	02,03,04,05,06,07,08	Screw Thread	B-2 2 2 2 -MMMMMM-SA*	B-2 2 2 2 -HHHHHH-SA* B-04040404-HHHH-SA*	B-2 2 2 2 -6 7 8 9 -SA*
		2 point lock bayonet	B-2 2 2 2 -MMMMMM-LA*	B-2 2 2 2 -HHHHHH-LA*	B-2 2 2 2 -6 7 8 9 -LA*
2A	10,12	Screw Thread	B-2 2 2 2 -MMMMMM-SA*	B-2 2 2 2 -HHHHHH-SA*	B-2 2 2 2 -6 7 8 9 -SA*
		2 point lock bayonet	B-2 2 2 2 -MMMMMM-LA*	B-2 2 2 2 -HHHHHH-LA*	B-2 2 2 2 -6 7 8 9 -LA*

* Design and specification are subject to change without notice.

Accessories - Box

Box > USB > 2.0 Type A, 2.0 Type B

■ Customized – Upon Request

Type	Ports	P/N
2.0 Type A	1	BOX-USA11
	2	BOX-USA22
	4	BOX-USA44
2.0 Type B	1	BOX-USB11
	2	BOX-USB22
	4	BOX-USB44

Accessories - Tool

Wrench > Circular > Standard Size:
5/8"-27 UNS

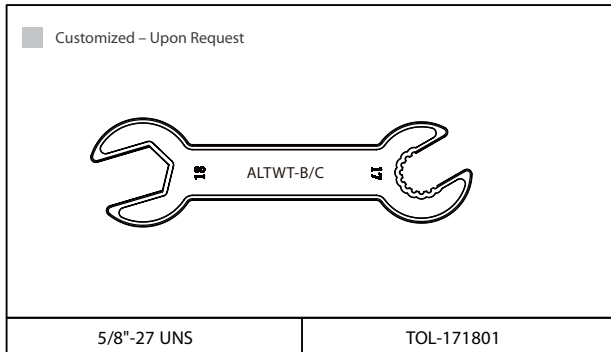

Wrench > Circular > Middle Size:
13/16"-28 UNS

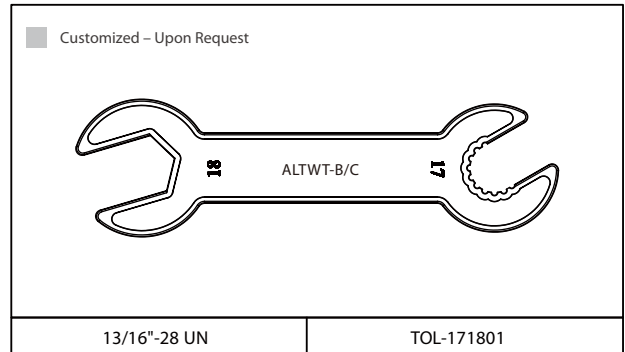

Wrench > Circular > Large Size:
1"-20 UNEF

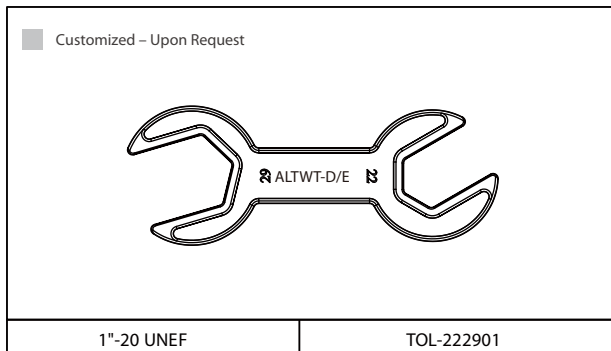

Unlock Tool > Cable Joiner >
8~10mm/10~12mm/12~16mm

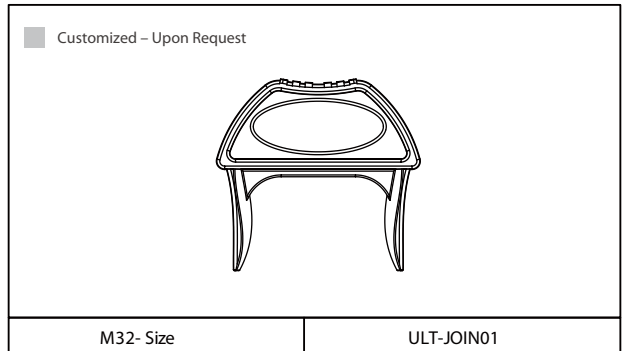

Accessories - Joint

∨ Joint > D-SUB > Standard & High Density

■ Customized – Upon Request

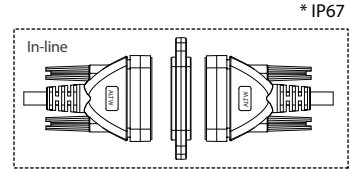
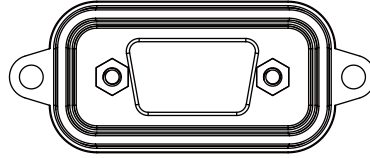

Type		Mating Style	P/N
Standard D-SUB	High Density D-SUB		
Standard (9 pins)	High Density (15 Pins)	Screw Thread	DJ1-00JNNA-SL7001
Standard (15 pins)	High Density (26 Pins)	Screw Thread	DJ2-00JNNA-SL7001
Standard (25 pins)	High Density (44 Pins)	Screw Thread	DJ3-00JNNA-SL7001

Accessories - Patch Cable (Double-ended)

▾ Patch Cable (Double-ended) > RJ

■ Customized – Upon Request

Gold Plated 6u"
Pitch 2.54mm
Select cable length 10cm/20cm/30cm

End 1		End 2		P/N
Type	Gender	Type	Gender	
RJ 45 Unshielded	Plug	RJ 45 Unshielded	Pin Header	UPG06-CHOP1-C10
			Plug	UPG06-UPG06-C10

* Design and specification are subject to change without notice.

Компания «Океан Электроники» предлагает заключение долгосрочных отношений при поставках импортных электронных компонентов на взаимовыгодных условиях!

Наши преимущества:

- Поставка оригинальных импортных электронных компонентов напрямую с производств Америки, Европы и Азии, а так же с крупнейших складов мира;
- Широкая линейка поставок активных и пассивных импортных электронных компонентов (более 30 млн. наименований);
- Поставка сложных, дефицитных, либо снятых с производства позиций;
- Оперативные сроки поставки под заказ (от 5 рабочих дней);
- Экспресс доставка в любую точку России;
- Помощь Конструкторского Отдела и консультации квалифицированных инженеров;
- Техническая поддержка проекта, помощь в подборе аналогов, поставка прототипов;
- Поставка электронных компонентов под контролем ВП;
- Система менеджмента качества сертифицирована по Международному стандарту ISO 9001;
- При необходимости вся продукция военного и аэрокосмического назначения проходит испытания и сертификацию в лаборатории (по согласованию с заказчиком);
- Поставка специализированных компонентов военного и аэрокосмического уровня качества (Xilinx, Altera, Analog Devices, Intersil, Interpoint, Microsemi, Actel, Aeroflex, Peregrine, VPT, Syfer, Eurofarad, Texas Instruments, MS Kennedy, Miteq, Cobham, E2V, MA-COM, Hittite, Mini-Circuits, General Dynamics и др.);

Компания «Океан Электроники» является официальным дистрибьютором и эксклюзивным представителем в России одного из крупнейших производителей разъемов военного и аэрокосмического назначения «**JONHON**», а так же официальным дистрибьютором и эксклюзивным представителем в России производителя высокотехнологичных и надежных решений для передачи СВЧ сигналов «**FORSTAR**».



JONHON

«**JONHON**» (основан в 1970 г.)

Разъемы специального, военного и аэрокосмического назначения:

(Применяются в военной, авиационной, аэрокосмической, морской, железнодорожной, горно- и нефтедобывающей отраслях промышленности)

«**FORSTAR**» (основан в 1998 г.)

ВЧ соединители, коаксиальные кабели,
кабельные сборки и микроволновые компоненты:

(Применяются в телекоммуникациях гражданского и специального назначения, в средствах связи, РЛС, а так же военной, авиационной и аэрокосмической отраслях промышленности).



Телефон: 8 (812) 309-75-97 (многоканальный)

Факс: 8 (812) 320-03-32

Электронная почта: ocean@oceanchips.ru

Web: <http://oceanchips.ru/>

Адрес: 198099, г. Санкт-Петербург, ул. Калинина, д. 2, корп. 4, лит. А