

# B-Series Circuit Breaker

The B-Series hydraulic/magnetic circuit breakers are compact and temperature stable designed for precision operation in OEM markets requiring general purpose as well as full load amp applications. These circuit breakers are designed specifically for world market applications requiring extra insulation and tongue & groove half-shell constructions. Actuators available include handle for 1- 6 poles, rocker for 1-3 poles, and Visi-Rocker for 1-3 poles construction. They are also offered with ratings from 0.02 to 50 amps and up to 277VAC or 80VDC, with choices of time delays, terminals, wide range of standard colors, imprinting.

#### Additional Features:

- ♦ Meet CSA Standard 22.2 No. 100 for the Generator & Welder markets
- ♦ Extra insulation and tongue & groove half-shell constructions

#### Applications:

- ♦ Power Supplies
- ♦ Medical Equipment
- ♦ Generator & Welder Markets
- ♦ Office Equipment
- ♦ Control Panels
- ♦ Marine
- ♦ Military



1 POLE



2 POLE

#### Agency Certifications:

- ♦ UL Recognized – *UL Standard 508, 1077, 1500*
- ♦ UL Listed – *UL Standard 489, 489A*
- ♦ CSA Accepted
- ♦ TUV Certified
- ♦ VDE Certified



**Carling Technologies®**

Innovative Designs. Powerful Solutions.

Innovative Designs. Powerful Solutions.

Carling Technologies, Inc.  
60 Johnson Avenue • Plainville, CT 06062-1177  
Phone: (860) 793-9281 • Fax: (860) 793-9231  
Email: [sales@carlingtech.com](mailto:sales@carlingtech.com) • [www.carlingtech.com](http://www.carlingtech.com)

## Electrical

Maximum Voltage 277VAC 50/60 Hz, 80VDC  
 Current Ratings Standard current coils: 0.100, 0.250, 0.500, 0.750, 1.00, 2.50, 5.00, 7.50, 10.0, 15.0, 20.0, 25.0, 30.0, 35.0, 40.0 and 50.0 amps. Other ratings available, see ordering scheme.  
 Standard Voltage Coils DC - 6V, 12V; AC - 120V, other ratings available, see ordering scheme.  
 Auxiliary Switch Rating SPDT; 10.1 AMPS - 250VAC, 1.0A 65 VDC or 0.5A 80 VDC, 0.1 Amps - 125VAC (with gold contacts). VDE-1.0 Amp - 125VAC.  
 Insulation Resistance Minimum of 100 Megohms at 500 VDC.  
 Dielectric Strength UL, CSA - 1500 V 50/60 Hz for one minute between all electrically isolated terminals. B-Series circuit breakers comply with the 8mm spacing and 3750V 50/60 Hz dielectric requirements from hazardous voltage to operator accessible surfaces, between adjacent poles and from main circuits to auxiliary circuits per Publications EN 60950 and VDE 0805.  
 Resistance, Impedance Values from Line to Load Terminal - based on Series Trip Circuit Breaker.

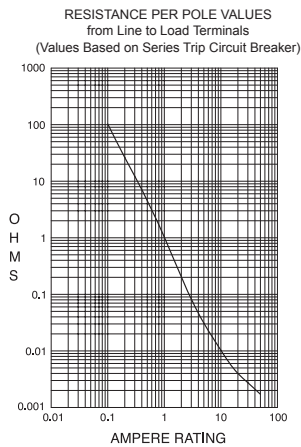

CURRENT (AMPS)	TOLERANCE (%)
0.10 - 5.0	15%
5.1 - 20.0	25%
20.1 - 50.0	35%

### Pulse Tolerance Curves



\*Manufacturer reserves the right to change product specification without prior notice.

## Mechanical

Endurance 6,000 ON-OFF operations @ 6 per minute; with rated Current and Voltage. Additional 4,000 ON-OFF mechanical  
 Trip Free All B-Series Circuit Breakers will trip on overload, even when Handle is forcibly held in the ON position.  
 Trip Indication The operating Handle moves positively to the OFF position when an overload causes the breaker to trip.

## Physical

Number of Poles 1 - 6 poles at 30 Amps or less. 1 and 2 poles at 31 Amps thru 50 Amps.  
 Internal Circuit Config. Series, (with or without auxiliary switch), Shunt and Relay with current or voltage trip coils, Dual Coil, Switch Only (with or without auxiliary switch).  
 Weight Approximately 65 grams/pole. (Approximately 2.32 ounces/pole)  
 Standard Colors Housing - Black; Actuator- See Ordering Scheme.

## Environmental

Designed and tested in accordance with requirements of specification MIL-PRF-55629 & MIL-STD-202 as follows:  
 Shock Withstands 100 Gs, 6ms, sawtooth while carrying rated current per Method 213, Test Condition "I". Instantaneous and ultra-short curves tested @ 90% of rated current.  
 Vibration Withstands 0.060" excursion from 10-55 Hz, and 10 Gs 55-500 Hz, at rated current per Method 204C, Test Condition A. Instantaneous and ultrashort curves tested at 90% of rated current.  
 Moisture Resistance Method 106D; ten 24-hour cycles @ +25°C to +65°C, 80-98% RH.56 days @ +85°C, 85% RH.  
 Salt Spray Method 101, Condition A (90-95% RH @ 5% NaCl Solution, 96 hrs).  
 Thermal Shock Method 107D, Condition A (Five cycles @ -55°C to +25°C to +85°C to +25°C).  
 Operating Temperature -40°C to +85°C.

## Electrical Tables

**Table A:** Lists UL Recognized & CSA Certified configurations and performance capabilities as a Component Supplementary Protector.

B-SERIES TABLE A: COMPONENT SUPPLEMENTARY PROTECTORS										
CIRCUIT CONFIGURATION	VOLTAGE			CURRENT RATING		SHORT CIRCUIT CAPACITY (AMPS)		APPLICATION CODES		CONSTRUCTION NOTES
	MAX. RATING	FREQUENCY	PHASE	FULL LOAD AMPS	GENERAL PURPOSE AMPS	UL/CSA		UL	CSA	
						WITH BACKUP FUSE	WITHOUT BACKUP FUSE			
SERIES	65	DC	--	31 - 50	--	--	7500	TC1,2, OL1,U1	TC1,2, OL1,U1	
	80	DC	--	0.02 - 30	--	--	7500	TC1,2, OL1,U1	TC1,2, OL1,U1	
				--	31 - 50	--	7500	TC1,2, OL0,U1	TC1,2, OL0,U1	
	125	50 / 60	1	1 - 50	--	--	2000	TC1, OL1,U2	TC1, OL1,U2	
	125	50 / 60	1 <sup>4</sup>	1 - 50	--	--	1000	TC1, OL1,U2	TC3, OL1,U3	
	125 / 250	50 / 60	1 <sup>3</sup>	0.02 - 30	--	--	3000	TC1,2, OL1,U1	TC1,2, OL1,U1	
	250	50 / 60	1	0.02 - 30	--	--	1500	TC1, OL0,U2	TC1, OL0,U2	Single Pole Break
				0.02 - 30	--	--	3000	TC1, OL1,U2	TC1, OL1,U2	Two Pole Break
				--	31 - 50	--	3000	TC1,2, OL0,U1	TC1,2, OL0,U1	
			1 <sup>4</sup>	1 - 50	--	1000	TC1, OL1,U2	TC3, OL1,U3		
			3	0.02 - 30	--	5000 <sup>2</sup>	--	TC1,2, OL1,C1	TC1,2, OL1,C1	
				31 - 50	--	2000 <sup>1</sup>	--	TC1,2, OL1,C1	TC1,2, OL1,C1	
277	50 / 60	1	0.02 - 30	--	5000 <sup>1</sup>	--	TC1,2, OL1,C1	TC1,2, OL1,C1		
DUAL COIL	65	DC	--	0.02 - 50	--	--	7500	TC1,2, OL1,U1	TC1,2, OL1,U1	
	80	DC	--	0.02 - 30	--	--	7500	TC1,2, OL1,U1	TC1,2, OL1,U1	
				--	31 - 50	--	7500	TC1,2, OL0,U1	TC1,2, OL0,U1	
	125	50 / 60	1	1 - 50	--	--	2000	TC1, OL1,U2	TC1, OL1,U2	
	125 / 250	50 / 60	1 <sup>3</sup>	0.02 - 30	--	--	3000	TC1,2, OL1,U1	TC1,2, OL1,U1	
	250	50 / 60	1	0.02 - 30	--	--	1500	TC1, OL0,U2	TC1, OL0,U2	Single Pole Break
				0.02 - 30	--	--	3000	TC1, OL1,U2	TC1, OL1,U2	Two Pole Break
				--	31 - 50	--	3000	TC1,2, OL0,U1	TC1,2, OL0,U1	
			1 <sup>4</sup>	1 - 50	--	1000	TC1, OL1,U2	TC3, OL1,U3		
			3	0.02 - 30	--	5000 <sup>2</sup>	--	TC1,2, OL1,C1	TC1,2, OL1,C1	
				31 - 50	--	2000 <sup>1</sup>	--	TC1,2, OL1,C1	TC1,2, OL1,C1	
	277	50 / 60	1	0.02 - 30	--	5000 <sup>1</sup>	--	TC1,2, OL1,U1	TC1,2, OL1,U1	
SHUNT	80	DC	--	0.02 - 30	--	--	7500	TC1,2, OL1,U1	TC1,2, OL1,U1	
	125 / 250	50 / 60	1 <sup>3</sup>	0.02 - 30	--	--	3000	TC1,2, OL1,U1	TC1,2, OL1,U1	
	250	50 / 60	1	0.02 - 30	--	--	3000	TC1,2, OL1,U1	TC1,2, OL1,U1	
			3	0.02 - 30	--	5000 <sup>2</sup>	--	TC1,2, OL1,C1	TC1,2, OL1,C1	
	277	50 / 60	1	0.02 - 30	--	5000 <sup>1</sup>	--	TC1,2, OL1,C1	TC1,2, OL1,C1	
	RELAY	80	DC	--	0.02 - 30	--	--	7500	TC1,2, OL1,U1	TC1,2, OL1,U1
125 / 250		50 / 60	1 <sup>3</sup>	0.02 - 30	--	--	3000	TC1,2, OL1,U1	TC1,2, OL1,U1	
250		50 / 60	1	0.02 - 30	--	--	3000	TC1,2, OL1,U1	TC1,2, OL1,U1	
			3	0.02 - 30	--	5000 <sup>2</sup>	--	TC1,2, OL1,C1	TC1,2, OL1,C1	
277		50 / 60	1	0.02 - 30	--	5000 <sup>1</sup>	--	TC1,2, OL1,C1	TC1,2, OL1,C1	
SWITCH ONLY		65	DC	--	0.02 - 50	--	--	--	--	--
	80	DC	--	0.02 - 30	--	--	--	--	--	
	250	50 / 60	1	--	31 - 50	--	--	--	--	
			3	0.02 - 50	--	--	--	--	--	
	277	50 / 60	1	0.02 - 30	31 - 50	--	--	--	--	

**Notes:**

- 1 Requires branch circuit backup with a UL LISTED Type K5 or RK5 fuse (15A minimum) at no more than 4 times the rating of the protector.
- 2 Same as note 1, except that backup fuse is limited to 80A maximum.
- 3 2 pole protector required (with one pole per power line) for: 250/125 VAC, 125/250 VAC and 208Y/120 VAC Power Systems. 1 pole protector required for : 125 VAC, 1Ø Power System.

## Electrical Tables

**Table B:** Lists UL Recognized, CSA, VDE & TUV Certified configurations & performance capabilities as a Component Supplementary Protector.

B-SERIES TABLE B: COMPONENT SUPPLEMENTARY PROTECTORS																	
CIRCUIT CONFIGURATION	VOLTAGE			CURRENT RATING		SHORT CIRCUIT CAPACITY (AMPS)						APPLICATION CODES		CONSTRUCTION NOTES			
	MAX. RATING	FREQUENCY	PHASE	FULL LOAD AMPS	GENERAL PURPOSE AMPS <sup>1</sup>	UL/CSA		VDE		TUV		UL	CSA				
						WITH BACKUP FUSE	WITHOUT BACKUP FUSE	(Inc) WITH BACKUP FUSE	(Inc) WITHOUT BACKUP	(Inc) WITH BACKUP FUSE	(Inc) WITHOUT BACKUP						
SERIES	80	DC	---	0.10 - 30	---	---	7500	3000	1500	3000	1500	TC1,2, OL1,U1	TC1,2, OL1,U1				
				31 - 50	31 - 50	---	7500	3000	1500	3000	1500	TC1,2, OL0,U1	TC1,2, OL0,U1				
				0.10 - 30	---	---	7500	3000	1500	3000	1500	TC1,2, OL1,U1	TC1,2, OL1,U1				
				31 - 32	---	---	7500	3000	1500	3000	1500	TC1,2, OL1,U1	TC1,2, OL1,U1				
	250	50 / 60	1	0.10 - 30	---	---	3000	3000	1500	5000	1500	TC1,2, OL1,U1	TC1,2, OL1,U1				
				31 - 50	31 - 50	---	3000	---	---	5000	1500	TC1,2, OL0,U1	TC1,2, OL0,U1				
				31 - 32	---	---	3000	6000	1500	5000	1500	TC1,2, OL1,U1	TC1,2, OL1,U1				
				0.10 - 30	---	---	1500	3000	1500	5000	1500	TC1, OL0,U2	TC1, OL0,U2	Single Pole Break			
				0.10 - 30	---	---	3000	3000	1500	5000	1500	TC1, OL1,U2	TC1, OL1,U2	Two Pole Break			
				3	0.10 - 30	---	5000 <sup>3</sup>	---	3000	1500	3000	1500	TC1,2, OL1,C1	TC1,2, OL1,C1			
				415	50 / 60	3	0.10 - 30	---	---	1000	3000	1500	3000	1500	TC1,2, OL1,C1	TC1,2, OL1,C1	
				DUAL COIL	80	DC	---	0.10 - 30	---	---	7500	3000	1500	3000	1500	TC1,2, OL1,U1	TC1,2, OL1,U1
0.10 - 30	---	---	3000					3000	1500	5000	1500	TC1,2, OL1,U1	TC1,2, OL1,U1				
250	50 / 60	1	30 - 50		31 - 50	---	3000	---	---	5000	1500	TC1,2, OL0,U1	TC1,2, OL0,U1				
			3		0.10 - 30	---	5000 <sup>3</sup>	---	3000	1500	3000	1500	TC1,2, OL1,C1	TC1,2, OL1,C1			
SHUNT	80	DC		---	0.10 - 30	---	---	7500	3000	1500	3000	1500	TC1,2, OL1,U1	TC1,2, OL1,U1			
			0.10 - 30		---	---	7500	3000	1500	3000	1500	TC1,2, OL1,U1	TC1,2, OL1,U1				
	250	50 / 60	1	0.10 - 30	---	---	3000	3000	1500	5000	1500	TC1,2, OL1,U1	TC1,2, OL1,U1				
				30 - 50	31 - 50	---	3000	---	---	5000	1500	TC1,2, OL0,U1	TC1,2, OL0,U1				
			3	0.10 - 30	---	5000 <sup>3</sup>	---	3000	1500	3000	1500	TC1,2, OL1,C1	TC1,2, OL1,C1				
				31 - 50	---	2000 <sup>2</sup>	---	---	---	3000	1500	TC1,2, OL1,C1	TC1,2, OL1,C1				

Notes:

- 1 General Purpose Ratings for UL/CSA Only.
- 2 Requires branch circuit backup with a UL LISTED Type K5 or RK5 fuse (15A minimum) at no more than 4 times the rating of the protector.
- 3 Same as note 1, except that backup fuse is limited to 80 A maximum.

**Table C:** Lists UL Recognized, CSA Certified configurations and performance capabilities as Protectors, Supplementary for Marine Electrical and Fuel Systems (CCN/Guide PEQZ2, File E75596). Ignition Protected per UL 1500. UL Classified Small Craft Electrical Devices, Marine in accordance with ISO 8846 (CCN/Guide UZMK, File MQ1515) as Marine Supplementary Protectors.

B-SERIES TABLE C: UL1500 (Marine Ignition Protected)							
CIRCUIT CONFIGURATION	VOLTAGE			CURRENT RATING	SHORT CIRCUIT CAPACITY (AMPS)	APPLICATION CODES	
	MAX. RATING	FREQUENCY	PHASE	FULL LOAD AMPS	WITHOUT BACKUP FUSE	UL	CSA
SERIES	14 <sup>1</sup>	DC	---	0.02 - 50	5000	TC1,2,OL1,U1	TC1,2,OL1,U1
	32 <sup>1</sup>	DC	---	0.02 - 50	5000	TC1,2,OL1,U2	TC1,2,OL1,U2
	65	DC	---	0.02 - 50	3000	TC1,2,OL1,U1	TC1,2,OL1,U1
	125 / 250	50 / 60	1 <sup>2</sup>	0.02 - 50	1500	TC1,2,OL1,U1	TC1,2,OL1,U1
	250	50 / 60	1	0.02 - 30	1000	TC1,2,OL1,U1	TC1,2,OL1,U1

Notes:

- 1 Available with special catalog number only (consult factory).
- 2 2 pole protector required (with one pole per power line) for: 250/125 VAC, 125/250 VAC and 208Y/120 VAC Power Systems. 1 pole protector required for: 125 VAC, 1Ø Power System.

**Table D:** Lists UL Listed configurations and performance capabilities as Circuit Breakers for use in Communications Equipment (CCN/Guide DITT, File E189195), under UL489A

B-SERIES TABLE D: UL489A (COMMUNICATIONS EQUIPMENT)				
CIRCUIT CONFIGURATION	VOLTAGE		CURRENT RATING	INTERRUPTING CAPACITY (AMPS)
	MAX. RATING	FREQUENCY	GENERAL PURPOSE AMPS	WITHOUT BACKUP FUSE
SERIES	80	DC	0.10 - 50	5000
	80	DC	60 - 90 <sup>1</sup>	5000

Notes:  
1 Parallel Pole Construction

**Table E:** Lists UL Listed (489) configuration and performance capabilities as a Molded Case Circuit Breaker.

B SERIES TABLE E : UL489 LISTED BRANCH CIRCUIT BREAKERS						
CIRCUIT CONFIGURATION	VOLTAGE			CURRENT RATING	INTERRUPTING CAPACITY (AMPS)	CONSTRUCTION NOTES
	MAX. RATING	FREQUENCY	PHASE	FULL LOAD AMPS	WITHOUT BACKUP FUSE	
SERIES	120	50 / 60	1	0.10 - 30	5,000	1 Pole
	120 / 240	50 / 60	1	0.10 - 30	5,000	2 Poles
	120 / 240	50 / 60	1	0.10 - 30	5,000	2 or 3 Poles (1 Pole of a 3 Pole Unit is for Neutral Break)
SHUNT TRIP DUAL COIL	120	50 / 60	1	0.10 - 30	5,000	1 Pole
	120 / 240	50 / 60	1	0.10 - 30	5,000	2 Poles
	120 / 240	50 / 60	1	0.10 - 30	5,000	2 or 3 Poles (1 Pole of a 3 Pole Unit is for Neutral Break)

## Agency Certifications

### UL Recognized

UL Standard 1077



Component Recognition Program as Protectors Supplementary (Guide CCN/QVNU2, File E75596)

### CSA Accepted



Component Supplementary Protector under Class 3215 30, File 047848 0 000 CSA Standard C22.2 No. 235

UL Standard 508



Switches, Industrial Control (Guide CCN/NRNT2, File E148683)

### TUV Certified



EN60934, under License No. R72040875

UL Standard 1500



Protectors, Supplementary for Marine Electrical & Fuel Systems (Guide PEQZ2, File E75596) Ignition Protection

### VDE Certified



EN60934, VDE 0642 under File No. 10537

### UL Listed

UL Standard 489



Circuit Breakers, Molded Case, (Guide DIVQ, File E129899)

UL Standard 489A

Communications Equipment (Guide CCN/DITT, File E189195)





1 Series    2 Actuator    3 Poles    4 Circuit    5 Aux/Alarm Switch    6 Frequency & Delay    7 Current Rating    8 Terminal    9 Actuator Color    10 Mounting/Barriers    11 Agency Approval

**1 SERIES**  
B

**2 ACTUATOR**  
A Handle, one per pole  
B Handle, one per multipole unit  
S Mid-Trip Handle, one per pole  
T Mid-Trip Handle, one per pole & Alarm Switch

**3 POLES**  
1 One    2 Two    3 Three    4 Four    5 Five    6 Six

**4 CIRCUIT**  
A<sup>2</sup> Switch Only (No Coil)  
B Series Trip (Current)  
C Series Trip (Voltage)  
D<sup>3</sup> Shunt Trip (Current)  
E<sup>3</sup> Shunt Trip (Voltage)  
F<sup>3</sup> Relay Trip (Current)  
G<sup>3</sup> Relay Trip (Voltage)  
H<sup>3,4</sup> Dual Coil with Shunt Trip Voltage Coil  
H<sup>3,4</sup> Dual Coil with Shunt Trip Voltage Coil (side terminal)  
K<sup>3,4</sup> Dual Coil with Relay Trip Voltage Coil

**5 AUXILIARY/ALARM SWITCH<sup>5</sup>**  
0 w/o Aux Switch  
1 S.P.D.T., 0.093 Q.C. Term.  
2 S.P.D.T., 0.110 Q.C. Term.  
3 S.P.D.T., 0.139 Solder Lug  
4 S.P.D.T., 0.110 Q.C. Term. (Gold Contacts)  
5 S.P.S.T., 0.093 Q.C. Term. (Gold Contacts)  
6 S.P.S.T., 0.139 Solder Lug  
7 S.P.S.T., 0.110 Q.C. Term. (Gold Contacts)  
8 S.P.S.T., 0.187 Q.C. Term.  
9 S.P.D.T., 0.187 Q.C. Term.

**6 FREQUENCY & DELAY**  
03<sup>2</sup> DC 50/60Hz, Switch Only    30 DC, 50/60Hz Instantaneous  
10<sup>6</sup> DC Instantaneous    31 DC, 50/60Hz Ultra Short  
11 DC Ultra Short    32 DC, 50/60Hz Short  
12 DC Short    34 DC, 50/60Hz Medium  
14 DC Medium    36 DC, 50/60Hz Long  
16 DC Long    42<sup>7</sup> 50/60Hz Short, Hi-Inrush  
20<sup>6</sup> 50/60Hz Instantaneous    44<sup>7</sup> 50/60Hz Medium, Hi-Inrush  
21 50/60Hz Ultra Short    46<sup>7</sup> 50/60Hz Long, Hi-Inrush  
22 50/60Hz Short    52<sup>7</sup> DC, Short, Hi-Inrush  
24 50/60Hz Medium    54<sup>7</sup> DC, Medium, Hi-Inrush  
26 50/60Hz Long    56<sup>7</sup> DC, Long, Hi-Inrush

- Notes:
- Actuator Code:  
A: Handle tie pin spacer(s) and retainers provided unassembled with multi-pole units.  
B: Handle location as viewed from front of breaker:  
2 pole - left pole    3 pole - center pole  
4 pole - two handles at center poles    5 pole - three handles at center poles  
6 pole - four handles at center poles  
S: Handle moves to mid-position only upon electrical trip of the breaker. Available with circuit codes B, C, D, E, F, G, H and K.  
T: Handle moves to mid-position and alarm switch activates only upon electrical trip of the breaker. Available with circuit codes B & C.
  - Switch Only circuits, rated up to 50 amps and 6 poles, and only available with VDE Certification when tied to a protected pole (Circuit Code B, C, D or H), For .02 to 30 amps, select Current Code 630. For 35 - 50 amps, select Current Code 650.
  - Available with Terminal Codes 1, 2 and 3. Current Rating limited to 30 amps maximum.
  - Consult factory for available Dual Coil options, as special catalog number is required. With Shunt construction, Dual Coils will trip instantaneously on line voltage. Dual coils require 30VA minimum power to trip and are rated for intermittent duty only.
  - Auxiliary Switch breakers with Series Trip and Switch Only circuits. On multi-pole breakers, one aux. switch is supplied, mounted in the extreme right pole.
  - Separate pole type voltage coils not rated for continuous duty. Available only with delay codes 10 and 20.
  - Available with Circuit Codes B & D only. VDE Certified to 30 amps. UL Recognized and CSA Accepted to 50 amps.
  - VDE Certification available with single pole breakers with DC Delay only. UL Recognition and CSA Accepted available in one and two pole breakers.
  - Screw Terminals are recommended on ratings greater than 20 amps. Ratings over 30 amps are only available with Terminal Codes 5, 9, G, H, J, K, M and Q.
  - VDE Certification up to 25 amps and UL Recognition and CSA Acceptance up to 30 amps, but not recommended over 20 amps.
  - Terminal Codes 3, 5 E and H (Bus Type) with VDE, are supplied with Lock Washers, and Terminal Code M (M6 Threaded Stud) with VDE is supplied with Lock and Flat Washers. These breakers are only VDE Certified when the washers are used.
  - VDE Cert. available up to 12 amps. UL Rec. & CSA Acceptance available up to 30 amps.
  - Single pole breakers with Terminal Code P (Printed Circuit Board) are available up to 30 amps with VDE Certification and 50 amps with UL Recognition and CSA Acceptance, with Circuit Codes A, B and C. Two pole breakers with Terminal Code P (Printed Circuit Board) are available up to 40 amps with UL Recognition and CSA Acceptance with Circuit Codes A, B and C.
  - Available with Actuator Codes A, S and T.
  - Available with voltage coils only.
  - Terminal Code Q not available with VDE approvals.

**7 CURRENT RATING (AMPERES)**

CODE	AMPERES				
020	0.020	225	0.250	420	2.000
025	0.025	230	0.300	522	2.250
030	0.030	235	0.350	527	2.750
035	0.035	240	0.400	430	3.000
040	0.040	245	0.450	435	3.500
045	0.045	250	0.500	440	4.000
050	0.050	255	0.550	445	4.500
055	0.055	260	0.600	450	5.000
060	0.060	265	0.650	455	5.500
065	0.065	270	0.700	460	6.000
070	0.070	275	0.750	465	6.500
075	0.075	280	0.800	470	7.000
080	0.080	285	0.850	475	7.500
085	0.085	290	0.900	480	8.000
090	0.090	295	0.950	485	8.500
095	0.095	410	1.000	490	9.000
210	0.100	512	1.250	495	9.500
215	0.150	415	1.500	610	10.000
220	0.200	517	1.750	710	10.500

**OR VOLTAGE COIL (NORMAL RATED VOLTAGE)<sup>6</sup>**

A06	6 DC	A32	32 DC	J12	12 AC	K65	65 AC
A12	12 DC	A48	48 DC	J18	18 AC	J60	120 AC
A18	18 DC	A65	65 DC	J24	24 AC	L40	240 AC
A24	24 DC	J06	6 AC	J48	48 AC		

**8 TERMINAL<sup>9</sup>**

1 <sup>10</sup>	Push-On 0.250 Tab (Q.C.)	G	Screw M5 (Bus Type) and 30° bend
2	Screw 8-32 w/upturned lugs	H	Screw M5 (Bus Type)
3 <sup>11</sup>	Screw 8-32 (Bus Type)	J	Screw 10-32 w/upturned lugs
4	Screw 10-32 (Bus Type)	K	Screw 10-32 Back Connect
5 <sup>11</sup>	Screw 10-32 (Bus Type)	L <sup>12</sup>	0.250 Q.C./ Solder Lug
6	Screw 8-32 w/upturned lugs and 30° bend	M <sup>11</sup>	M6 Threaded Stud
7	Screw 8-32 (Bus Type) and 30° bend	N	Screw M4 Back Connect
8	Screw 10-32 w/upturned lugs and 30° bend	P <sup>13</sup>	Printed Circuit Board Terminals
9	Screw 10-32 (Bus Type) and 30° bend	Q <sup>16</sup>	Push-In Stud
B	Screw M5 w/upturned lugs	R	Screw M4 w/upturned lugs and 30° bend
C	Screw M4 w/upturned lugs	S <sup>15</sup>	Push-On 0.110 Tab (Q.C.)
E <sup>11</sup>	Screw M4 (Bus Type)	T	Screw M4 (Bus Type) and 30° bend
F	Screw M5 w/upturned lugs and 30° bend	Y	Screw 8-32 Back Connect

**9 ACTUATOR COLOR & LEGEND**

Actuator Color	I-O	ON-OFF	Dual	Legend Color
White	A	B	1	Black
Black	C	D	2	White
Red	F	G	3	White
Green	H	J	4	White
Blue	K	L	5	White
Yellow	M	N	6	Black
Gray	P	Q	7	Black
Orange	R	S	8	Black

**10 MOUNTING/BARRIERS**

	MOUNTING STYLE	BARRIERS
	<b>Threaded Insert, 2 per pole</b>	
1	6-32 x 0.195 inches	no
A	6-32 x 0.195 inches (multi-pole units only)	yes
2	ISO M3 x 5mm	no
B	ISO M3 x 5mm	yes
	<b>Rectangular Adapter Plate with mounting centers of 2.062 inches [52.37mm] and Threaded insert, 2 per pole</b>	
3 <sup>14</sup>	6-32 x 0.225 inches	no
C <sup>14</sup>	6-32 X 0.225 inches (multi-pole units only)	yes
4 <sup>14</sup>	ISO M3 x 6.5mm	no
D <sup>14</sup>	ISO M3 x 6.5mm	yes
	<b>Front panel Snap-In, 0.75" [19.05mm] wide bezel</b>	
5	without Handleguard	no
6	without Handleguard (multipole only)	yes
	<b>Front panel Snap-In, 0.96" wide bezel</b>	
7	without Handleguard, 1-pole 0.96" wide;	no
	multipole units have .105" bezel overhang on all sides	
8	without Handleguard, 1-pole 0.96" wide;	yes
	(multipole only) .105" bezel overhang on all sides	

**11 AGENCY APPROVAL**

C	UL Recognized & CSA Accepted
D	VDE Certified, UL Recognized & CSA Accepted
E	TUV Certified, UL Recognized & CSA Accepted
I	UL Rec. STD 1077, UL Rec. 1500 (ignition protected), & CSA Accepted

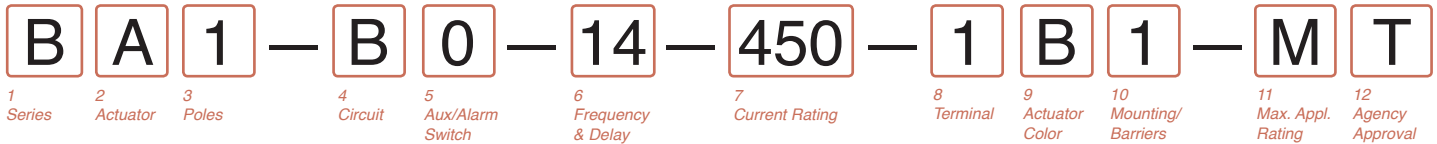

**1 SERIES**  
**B**

**2 ACTUATOR<sup>1</sup>**  
**A** Handle, one per pole  
**B** Handle, one per multipole unit  
**S** Mid-Trip Handle, one per pole  
**T** Mid-Trip Handle, one per pole & Alarm Switch

**3 POLES<sup>2</sup>**  
**1** One **3** Three  
**2** Two **4** Four

**4 CIRCUIT**  
**B** Series Trip (Current)

**5 AUXILIARY/ALARM SWITCH<sup>2</sup>**  
**0** w/o Aux Switch **7** S.P.S.T., 0.110 Q.C. Term.  
**1** S.P.D.T., 0.093 Q.C. Term. (Gold Contacts)  
**2** S.P.D.T., 0.110 Q.C. Term. **8** S.P.S.T., 0.187 Q.C. Term.  
**3** S.P.D.T., 0.139 Solder Lug **9** S.P.D.T., 0.187 Q.C. Term.

**6 FREQUENCY & DELAY<sup>4</sup>**  
**11** DC Ultra Short **52** DC, Short, Hi-Inrush  
**12** DC Short **54** DC, Medium, Hi-Inrush  
**14** DC Medium **56** DC, Long, Hi-Inrush  
**16** DC Long

**7 CURRENT RATING (AMPERES)**

CODE	AMPERES				
210	0.100	285	0.850	455	5.500
215	0.150	290	0.900	460	6.000
220	0.200	295	0.950	465	6.500
225	0.250	410	1.000	470	7.000
230	0.300	512	1.250	475	7.500
235	0.350	415	1.500	480	8.000
240	0.400	517	1.750	485	8.500
245	0.450	420	2.000	490	9.000
250	0.500	522	2.250	495	9.500
255	0.550	527	2.750	610	10.000
260	0.600	430	3.000	710	10.500
265	0.650	435	3.500	611	11.000
270	0.700	440	4.000	711	11.500
275	0.750	445	4.500	612	12.000
280	0.800	450	5.000	712	12.500
				613	13.000
				614	14.000
				615	15.000
				616	16.000
				617	17.000
				618	18.000
				620	20.000
				622	22.000
				624	24.000
				625	25.000
				630	30.000
				635 <sup>3</sup>	35.000
				640 <sup>3</sup>	40.000
				645 <sup>3</sup>	45.000
				650 <sup>3</sup>	50.000

**8 TERMINAL<sup>4</sup>**

1 <sup>5</sup>	Push-On 0.250 Tab (Q.C.)	<b>B</b>	Screw M5 w/upturned lugs
2	Screw 8-32 w/upturned lugs	<b>F</b>	Screw M5 w/upturned lugs and 30° bend
3 <sup>6</sup>	Screw 8-32 (Bus Type)	<b>G</b>	Screw M5 (Bus Type) and 30° bend
4	Screw 10-32 w/upturned lugs	<b>H</b>	Screw M5 (Bus Type)
5 <sup>6</sup>	Screw 10-32 (Bus Type)	<b>J</b>	Screw M5 Back Connect
6	Screw 8-32 w/upturned lugs and 30° bend	<b>K</b>	Screw 10-32 Back Connect
7	Screw 8-32 (Bus Type) and 30° bend	<b>M<sup>9</sup></b>	M6 Threaded Stud
8	Screw 10-32 w/upturned lugs and 30° bend	<b>N</b>	Screw M4 Back Connect
9	Screw 10-32 (Bus Type) and 30° bend	<b>P<sup>7</sup></b>	Printed Circuit Board Terminals
		<b>Q<sup>8</sup></b>	Push-In Stud
		<b>Y</b>	Screw 8-32 Back Connect

**9 ACTUATOR COLOR & LEGEND**

Acuator Color	ON-OFF	Dual	Legend Color
White	<b>B</b>	<b>1</b>	Black
Black	<b>D</b>	<b>2</b>	White
Red	<b>G</b>	<b>3</b>	White
Green	<b>J</b>	<b>4</b>	White
Blue	<b>L</b>	<b>5</b>	White
Yellow	<b>N</b>	<b>6</b>	Black
Gray	<b>Q</b>	<b>7</b>	Black
Orange	<b>S</b>	<b>8</b>	Black

**10 MOUNTING/BARRIERS**

	MOUNTING STYLE	BARRIERS
	<b>Threaded Insert, 2 per pole</b>	
<b>1</b>	6-32 x 0.195 inches	no
<b>A</b>	6-32 x 0.195 inches (multi-pole units only)	yes
<b>2</b>	ISO M3 x 5mm	no
<b>B</b>	ISO M3 x 5mm	yes
	<b>Rectangular Adapter Plate with mounting centers of 2.062 inches [52.37mm] and Threaded insert, 2 per pole</b>	
<b>3</b>	6-32 x 0.225 inches	no
<b>C</b>	6-32 X 0.225 inches (multi-pole units only)	yes
<b>4</b>	ISO M3 x 6.5mm	no
<b>D</b>	ISO M3 x 6.5mm	yes
	<b>Front panel Snap-In, 0.75" [19.05mm] wide bezel</b>	
<b>5</b>	without Handleguard	no
<b>6</b>	without Handleguard (multipole only)	yes
	<b>Front panel Snap-In, 0.96" wide bezel</b>	
<b>7</b>	without Handleguard, 1-pole 0.96" wide;	no
	multipole units have .105" bezel overhang on all sides	
<b>8</b>	without Handleguard, 1-pole 0.96" wide;	yes
	(multipole only) .105" bezel overhang on all sides	

**11 MAXIMUM APPLICATION RATING**  
**M** 80 DC

**12 AGENCY APPROVAL**  
**T** UL489A LISTED  
**K** UL489A LISTED, VDE CERTIFIED  
**J** UL489A LISTED, TUV CERTIFIED

- Notes:
- Actuator Code:  
 A: Handle tie pin spacer(s) and retainers provided unassembled with multi-pole units.  
 S: Handle moves to mid-position only upon electrical trip of the breaker.  
 T: Handle moves to mid-position and alarm switch activates only upon electrical trip of the breaker.
  - On multi-pole breakers, one auxiliary switch is supplied, mounted in the extreme right pole.
  - VDE Certification available with single pole breakers only. UL489A Listing available with one and two pole breakers.
  - Screw Terminals are recommended on ratings greater than 20 amps. Ratings over 30 amps are only available with Terminal Codes 5, 9, G, H, J, K, M and Q.
  - Terminal Code 1 (Push-On) available up to 25 amps with TUV or VDE Certification and 30 amps with UL489A Listing, but is not recommended over 20 amps.
  - Terminal Codes 3, 5 and H (Bus Type) with TUV or VDE, are supplied with Lock Washers, and Terminal Code M (M6 Threaded Stud) with TUV or VDE is supplied with Lock and Flat Washers. These breakers are only TUV or VDE Certified when the washers are used.
  - Single pole breakers with Terminal Code P (Printed Circuit Board) are available up to 30 amps with VDE Certification and 50 amps with UL489A Listing.
  - Terminal Code Q not available with VDE approvals.





	CIRCUIT SCHEMATIC		CIRCUIT CODE	AUX SWITCH CODE	CIRCUIT SCHEMATIC		CIRCUIT CODE	AUX SWITCH CODE
	ANSI	IEC			ANSI	IEC		
	SERIES TRIP							
<p>SERIES TRIP (2 TERM'S.) MAIN TERM'S. (SEE TABLE A)</p>			A	O			B C	O
<p>SERIES TRIP W AUX SWITCH (5 TERM'S.) AUX. SWITCH TERM'S.</p>	<p>SWITCH ONLY (NO COIL) WITH AUXILIARY SWITCH</p>		A	2 3 4	<p>SERIES TRIP WITH AUXILIARY / ALARM SWITCH</p>		B C	2 3 4
<p>SHUNT TRIP (3 TERM'S.)</p>	<p>SHUNT TRIP</p>		D E	0	<p>DUAL COIL; SERIES TRIP CURRENT COIL, SHUNT TRIP VOLTAGE COIL</p>		H	0
<p>RELAY TRIP (4 TERM'S.)</p>	<p>RELAY TRIP</p>		F G	0	<p>DUAL COIL; SERIES TRIP CURRENT COIL, RELAY TRIP VOLTAGE COIL</p>		K	0

HANDLE POSITION VS. AUX/ALARM SWITCH MODE						
CIRCUIT BREAKER MODE	STANDARD C/B		MID TRIP C/B		MID TRIP C/B	
	HANDLE POSITION	AUX. SWITCH MODE	HANDLE POSITION	ALARM SWITCH MODE	HANDLE POSITION	AUX. SWITCH MODE (w/o ALARM SWITCH)
OFF						
ON						
ELECTRICAL TRIP						

- Notes:
- All dimensions are in inches [millimeters].
  - Tolerance ±.020 [.51] unless otherwise specified.
  - Alarm Switch available with .110 x .020 Q.C. & Solder Lug Terminals Only.

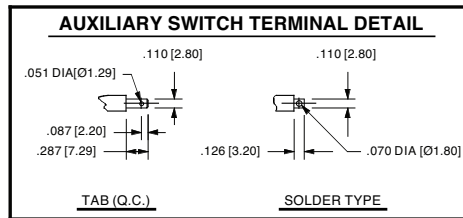

**TABLE A  
TIGHTENING TORQUE  
SPECIFICATIONS**

THREAD SIZE	TORQUE
#6-32 & M3 MOUNTING HARDWARE	7-9 IN-LBS [0.8-1.0 NM]
#8-32 & M4 THREAD TERMINAL SCREW	12-15 IN-LBS [1.4-1.7 NM]
#10-32 & M5 THREAD TERMINAL SCREW	15-20 IN-LBS [1.7-2.3 NM]



**TABLE B**

TERMINAL DESCRIPTION		DEPTH BEHIND PANEL
MAIN	TAB (Q.C.)	2.090 [53.09]
	SCREW TYPE	2.122 [53.90]
SHUNT, RELAY & DUAL COIL	TAB (Q.C.)	2.612 [66.35]
	SCREW #8-32 W/UPTURNED LUGS	2.644 [67.16]
AUX. SWITCH*	TAB (Q.C.) .110 x .020	2.537 [64.44]
	SOLDER TYPE	2.348 [59.64]

\* AVAILABLE ON SERIES TRIP AND SWITCH ONLY CIRCUITS. WHEN CALLED FOR ON MULTI-POLE UNITS, ONLY ONE AUX. SWITCH IS NORMALLY SUPPLIED, AS SHOWN IN MULTI-POLE IDENTIFICATION SCHEME.

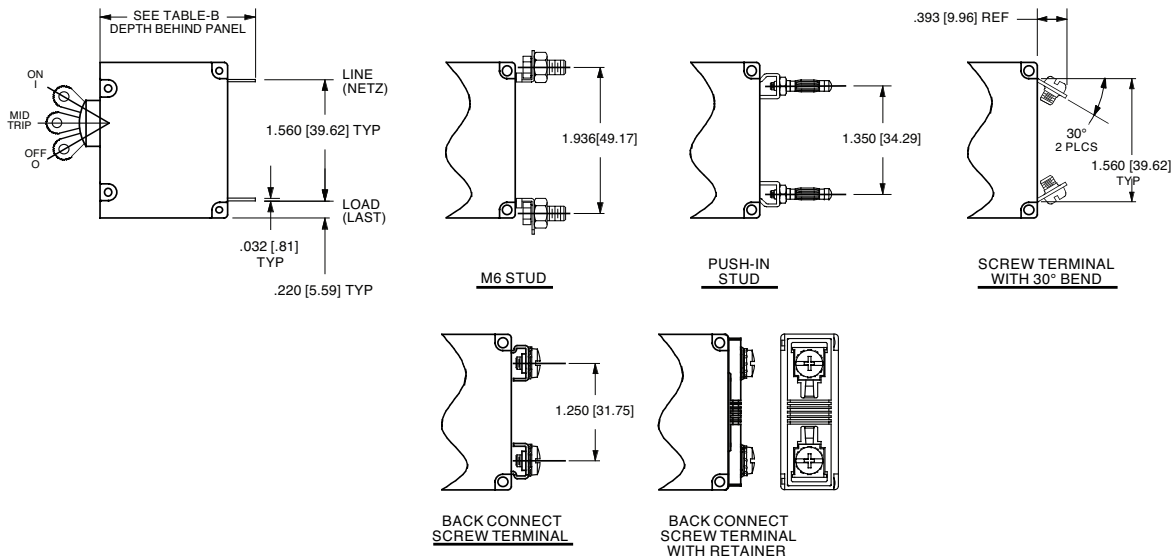

Notes:

- 1 All dimensions are in inches [millimeters].
- 2 Tolerance ±.020 [.51] unless otherwise specified.



TAB (Q.C.) TYPE TERMINALS IN SERIES TRIP CIRCUIT CONFIGURATION SHOWN. FOR OTHER CONFIGURATIONS, SEE CIRCUIT AND TERMINAL DRAWINGS.



**PANEL CUTOUT DETAIL**  
TOLERANCES ±.005 [±.12]

Notes:

- 1 All dimensions are in inches [millimeters].
- 2 Tolerance ± 0.20 [.51] unless otherwise specified.



- Notes:  
 1 All dimensions are in inches [millimeters].  
 2 Recommended panel thickness: .040 [1.02] to .100 [2.54].  
 3 Tolerance  $\pm 0.020$  [.51] unless otherwise specified.



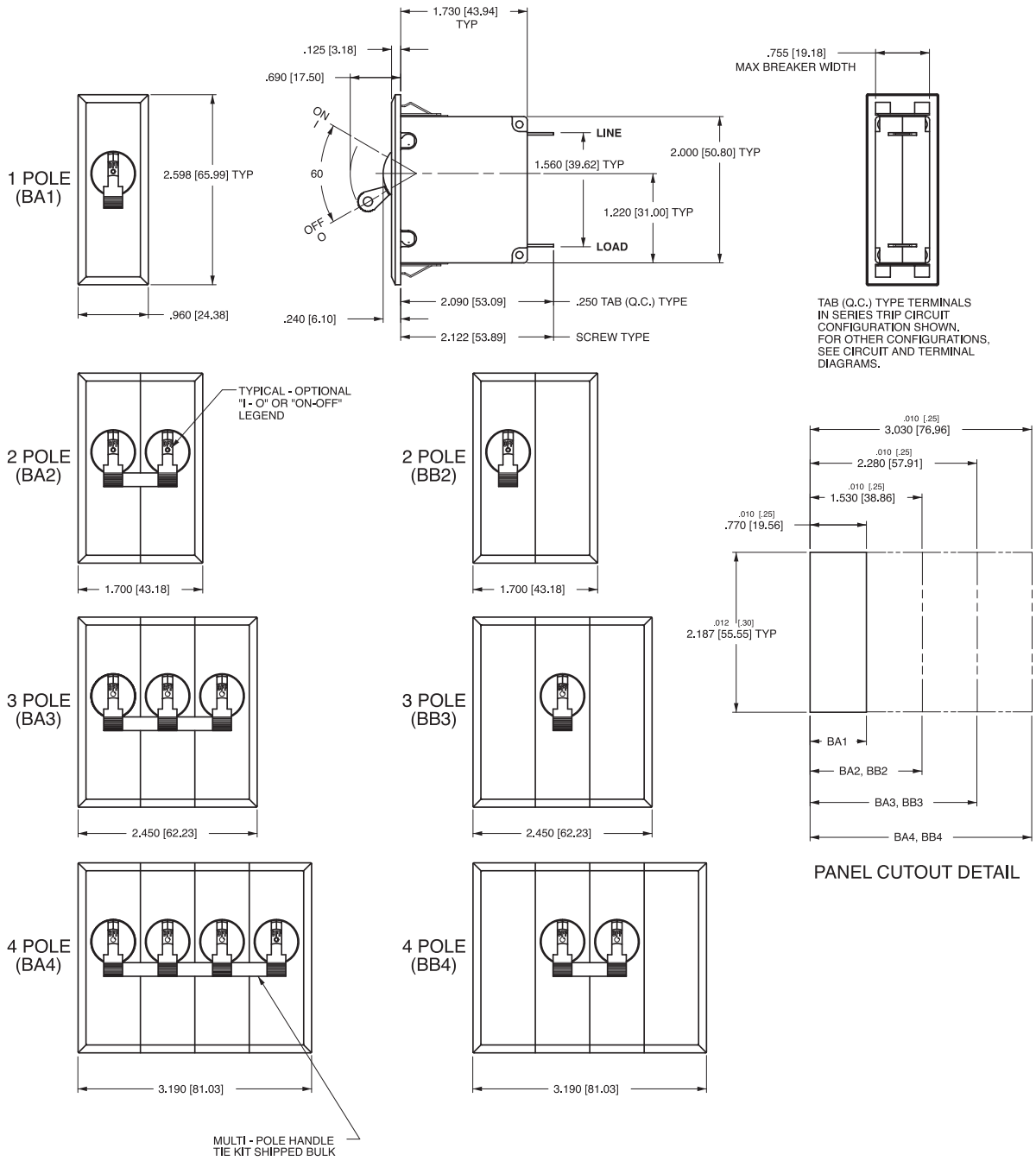

- Notes:
- 1 All dimensions are in inches [millimeters].
  - 2 Recommended panel thickness: .040 [1.02] to .100 [2.54].
  - 3 Tolerance  $\pm 0.020$  [.51] unless otherwise specified.

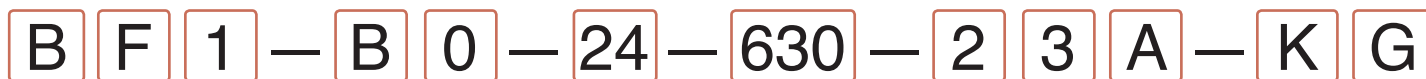

1 Series 2 Actuator 3 Poles 4 Circuit 5 Aux/Alarm Switch 6 Frequency & Delay 7 Current Rating 8 Terminal 9 Actuator Color 10 Mounting/Barriers 11 Max. Appl. Rating 12 Agency Approval

**1 SERIES**

**B**

**2 ACTUATOR**

**Two Color Visi-Rocker**

- C** Indicate ON, vertical legend
- D** Indicate ON, horizontal legend
- F** Indicate OFF, vertical legend
- G** Indicate OFF, horizontal legend

**Single color**

- J** Vertical legend
- K** Horizontal legend

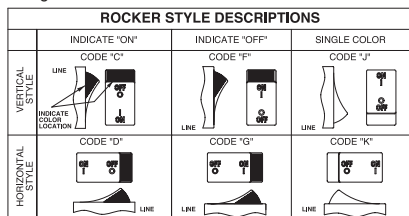

**8 TERMINAL<sup>5</sup>**

- |   |  |
|---|--|
| <b>1<sup>6</sup></b> Push-On 0.250 Tab (Q.C.)     | <b>B</b> Screw M5 w/upturned lugs              |
| <b>2</b> Screw 8-32 w/upturned lugs               | <b>C</b> Screw M4 w/upturned lugs              |
| <b>3</b> Screw 8-32 (Bus Type)                    | <b>F</b> Screw M5 w/upturned lugs and 30° bend |
| <b>4</b> Screw 10-32 w/upturned lugs              | <b>G</b> Screw M5 (Bus Type) and 30° bend      |
| <b>5</b> Screw 10-32 (Bus Type)                   | <b>H</b> Screw M5 (Bus Type)                   |
| <b>6</b> Screw 8-32 w/upturned lugs and 30° bend  | <b>J</b> Screw M5 Back Connect                 |
| <b>7</b> Screw 8-32 (Bus Type) and 30° bend       | <b>K</b> Screw 10-32 Back Connect              |
| <b>8</b> Screw 10-32 w/upturned lugs and 30° bend | <b>N</b> Screw M4 Back Connect                 |
| <b>9</b> Screw 10-32 (Bus Type) and 30° bend      | <b>Y</b> Screw 8-32 Back Connect               |

**9 ACTUATOR COLOR & LEGEND**

Actuator or Visi-Color <sup>7</sup>	Marking:			Marking Color	
	I-O	ON-OFF	Dual <sup>7</sup>	Single Color	Visi-Rocker
White	A	B	1	Black	White
Black	C	D	2	White	n/a
Red	F	G	3	White	Red
Green	H	J	4	White	Green
Blue	K	L	5	White	Blue
Yellow	M	N	6	Black	Yellow
Gray	P	Q	7	Black	Gray
Orange	R	S	8	Black	Orange

**3 POLES<sup>1,2</sup>**

**1** One                                      **2** Two                                      **3<sup>3</sup>** Three

**4 CIRCUIT**

**B** Series Trip (Current)

**5 AUXILIARY/ALARM SWITCH<sup>4</sup>**

- |                                     |   |
|-------------------------------------|---|
| <b>0</b> w/o Aux Switch             | <b>7</b> S.P.S.T., 0.110 Q.C. Term. (Gold Contacts) |
| <b>1</b> S.P.D.T., 0.093 Q.C. Term. | <b>8</b> S.P.S.T., 0.187 Q.C. Term.                 |
| <b>2</b> S.P.D.T., 0.110 Q.C. Term. | <b>9</b> S.P.D.T., 0.187 Q.C. Term.                 |
| <b>3</b> S.P.D.T., 0.139 Solder Lug |   |

**6 FREQUENCY & DELAY**

- |                          |                                 |
|--------------------------|---------------------------------|
| <b>21</b> AC Ultra Short | <b>42</b> AC, Short, Hi-Inrush  |
| <b>22</b> AC Short       | <b>44</b> AC, Medium, Hi-Inrush |
| <b>24</b> AC Medium      | <b>46</b> AC, Long, Hi-Inrush   |
| <b>26</b> AC Long        |                                 |

**7 CURRENT RATING (AMPERES)**

CODE	AMPERES				
210	0.100	285	0.850	455	5.500
215	0.150	290	0.900	460	6.000
220	0.200	295	0.950	465	6.500
225	0.250	410	1.000	470	7.000
230	0.300	512	1.250	475	7.500
235	0.350	415	1.500	480	8.000
240	0.400	517	1.750	485	8.500
245	0.450	420	2.000	490	9.000
250	0.500	522	2.250	495	9.500
255	0.550	527	2.750	610	10.000
260	0.600	430	3.000	710	10.500
265	0.650	435	3.500	611	11.000
270	0.700	440	4.000	711	11.500
275	0.750	445	4.500	612	12.000
280	0.800	450	5.000	712	12.500

**10 MOUNTING/BARRIERS**

MOUNTING STYLE	BARRIERS <sup>9</sup>
<b>Threaded Insert, 2 per pole</b>	
<b>A</b> 6-32 x 0.195 inches (multi-pole units only)	yes
<b>B</b> ISO M3 x 5mm	yes
<b>ROCKERGUARD BEZEL</b>	
<b>Threaded Insert, 2 per pole</b>	
<b>C</b> 6-32 X 0.225 inches (multi-pole units only)	yes
<b>D</b> ISO M3 x 6.5mm	yes

**11 MAXIMUM APPLICATION RATING**

- C<sup>8</sup>** 120/240 VAC
- K** 120 VAC

**12 AGENCY APPROVAL**

- G** UL489 Listed
- 3** UL489 Listed, TUV Certified

Notes:

- 1 Multi-pole breakers have all breakers identical except when specifying Aux. switch and/or mixed poles, and have one rocker per breaker.
- 2 All poles must be same polarity.
- 3 3 pole units available only when 1 of 3 poles is neutral.
- 4 On multi-pole breakers, one aux. switch is supplied, mounted in the extreme right pole.
- 5 Screw Terminals are recommended on ratings greater than 20 amps.
- 6 Terminal Code 1 (Push-On) available up to 30 amps, but are not recommended over 20 amps.
- 7 Dual legend = ON-OFF/I-O
- 8 Voltage Rating available with 2 and 3-pole breakers only.
- 9 Barriers supplied on multi-pole units only.

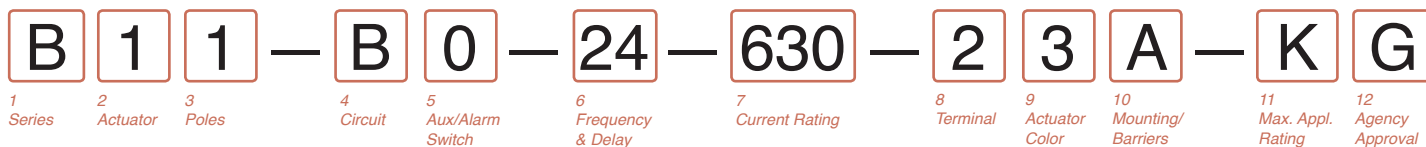

**1 SERIES**  
**B**

**2 ACTUATOR<sup>1</sup>**  
**Two Color Visi-Rocker**  
1 Indicate OFF, vertical legend  
2 Indicate OFF, horizontal legend  
**Single color**  
3 Vertical legend  
4 Horizontal legend  
**Push-To-Reset, Visi-Rocker**  
5 Indicate OFF, vertical legend  
6 Indicate OFF, horizontal legend  
**Push-To-Reset, Single color**  
7 Vertical legend  
8 Horizontal legend

	INDICATE "OFF"		SINGLE COLOR
	CODE "1", "5"	CODE "3", "7"	
VERTICAL STYLE			
HORIZONTAL STYLE			

**3 POLES<sup>2,3</sup>**  
1 One                                      2 Two                                      3<sup>4</sup> Three

**4 CIRCUIT**  
**B** Series Trip (Current)

**5 AUXILIARY/ALARM SWITCH<sup>4</sup>**

0 w/o Aux Switch	7 S.P.S.T., 0.110 Q.C. Term. (Gold Contacts)
1 S.P.D.T., 0.093 Q.C. Term.	8 S.P.S.T., 0.187 Q.C. Term.
2 S.P.D.T., 0.110 Q.C. Term.	9 S.P.D.T., 0.187 Q.C. Term.
3 S.P.D.T., 0.139 Solder Lug	

**6 FREQUENCY & DELAY**

21 AC Ultra Short	42 AC, Short, Hi-Inrush
22 AC Short	44 AC, Medium, Hi-Inrush
24 AC Medium	46 AC, Long, Hi-Inrush
26 AC Long	

**7 CURRENT RATING (AMPERES)**

CODE	AMPERES				
210	0.100	285	0.850	455	5.500
215	0.150	290	0.900	460	6.000
220	0.200	295	0.950	465	6.500
225	0.250	410	1.000	470	7.000
230	0.300	512	1.250	475	7.500
235	0.350	415	1.500	480	8.000
240	0.400	517	1.750	485	8.500
245	0.450	420	2.000	490	9.000
250	0.500	522	2.250	495	9.500
255	0.550	527	2.750	610	10.000
260	0.600	430	3.000	710	10.500
265	0.650	435	3.500	611	11.000
270	0.700	440	4.000	711	11.500
275	0.750	445	4.500	612	12.000
280	0.800	450	5.000	712	12.500

**8 TERMINAL<sup>5</sup>**

1 <sup>7</sup> Push-On 0.250 Tab (Q.C.)	<b>B</b> Screw M5 w/upturned lugs
2 Screw 8-32 w/upturned lugs	<b>C</b> Screw M4 w/upturned lugs
3 Screw 8-32 (Bus Type)	<b>F</b> Screw M5 w/upturned lugs and 30° bend
4 Screw 10-32 w/upturned lugs	<b>G</b> Screw M5 (Bus Type) and 30° bend
5 Screw 10-32 (Bus Type)	<b>H</b> Screw M5 (Bus Type) and 30° bend
6 Screw 8-32 w/upturned lugs and 30° bend	<b>J</b> Screw M5 Back Connect
7 Screw 8-32 (Bus Type) and 30° bend	<b>K</b> Screw 10-32 Back Connect
8 Screw 10-32 w/upturned lugs and 30° bend	<b>N</b> Screw M4 Back Connect
9 Screw 10-32 (Bus Type) and 30° bend	<b>Y</b> Screw 8-32 Back Connect

**9 ACTUATOR COLOR & LEGEND**

Actuator or Visi-Color <sup>8</sup>	Marking:			Marking Color	
	I-O	ON-OFF	Dual <sup>8</sup>	Single Color	Visi-Rocker
White	A	B	1	Black	White
Black	C	D	2	White	n/a
Red	F	G	3	White	Red
Green	H	J	4	White	Green
Blue	K	L	5	White	Blue
Yellow	M	N	6	Black	Yellow
Gray	P	Q	7	Black	Gray
Orange	R	S	8	Black	Orange

**10 MOUNTING/BARRIERS<sup>9</sup>**

<b>A</b> 6-32 x 0.195 inches (multi-pole units only)	STANDARD ROCKER BEZEL, Threaded Insert, 2 per pole	BARRIERS <sup>12</sup>
<b>B</b> ISO M3 x 5mm	FLAT ROCKER ACTUATOR	
<b>E</b> 6-32 X 0.225 inches (multi-pole units only)	RECESSED OFF SIDE ROCKER ACTUATOR <sup>10</sup>	
<b>F</b> ISO M3 x 6.5mm	PUSH-TO-RESET BEZEL, Threaded Insert, 2 per pole	
<b>C</b> 6-32 x 0.195 inches		
<b>D</b> ISO M3 x 5mm		

**11 MAXIMUM APPLICATION RATING**

**C<sup>11</sup>** 120/240VAC  
**K** 120VAC

**12 AGENCY APPROVAL**

**G** UL489 Listed  
**3** UL489 Listed, TUV Certified

- Notes:
- 1 Push-To-Reset actuators have OFF portion of rocker shrouded.
  - 2 Multi-pole breakers have all breakers identical except when specifying Aux. switch and/or mixed poles, and have one rocker per breaker.
  - 3 All poles must be same polarity.
  - 4 3 pole units available only when 1 of 3 poles is neutral.
  - 5 On multi-pole breakers, one aux. switch is supplied, mounted in the extreme right pole.
  - 6 Screw Terminals are recommended on ratings greater than 20 amps.
  - 7 Terminal Code 1 (Push-On) available up to 30 amps, but are not recommended over 20 amps.
  - 8 Color shown is visi and legend with remainder of rocker black, Dual = ON-OFF/I-O legend.
  - 9 Legend on Push-to-reset bezel/shroud is white with single color actuator codes 7 & 8. Legend on Push-To-Reset bezel/shroud matches Visi-Color of rocker with actuator codes 5 & 6.
  - 10 Recessed "off-side" available with actuator codes 1, 2, 3 & 4. Legends on rocker are available in ink stamping only.
  - 11 Voltage rating available with 2 & 3-pole breakers only.
  - 12 Barriers supplied on multi-pole units only.

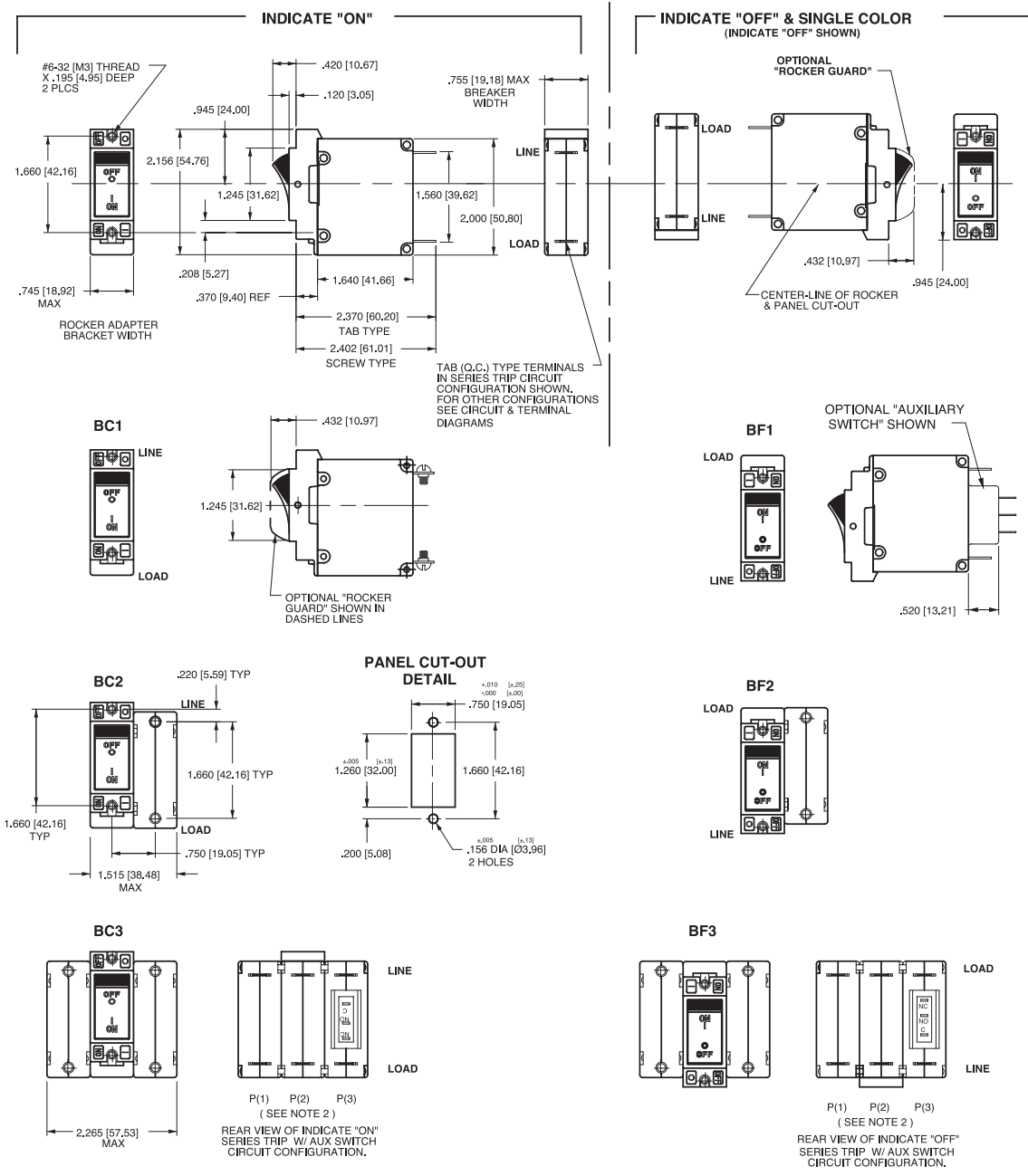

Notes:

- 1 Dimensions apply to all variations shown. Notice that circuit breaker line & load terminal orientation on indicate "OFF" is opposite of indicate "ON".
- 2 For pole orientation with horizontal legend, rotate front view clockwise 90°.
- 3 All dimensions are in inches [millimeters].
- 4 Tolerance  $\pm .020$  [.51] unless otherwise specified.



**INDICATE "OFF" & SINGLE COLOR**  
(INDICATE "OFF" SHOWN)

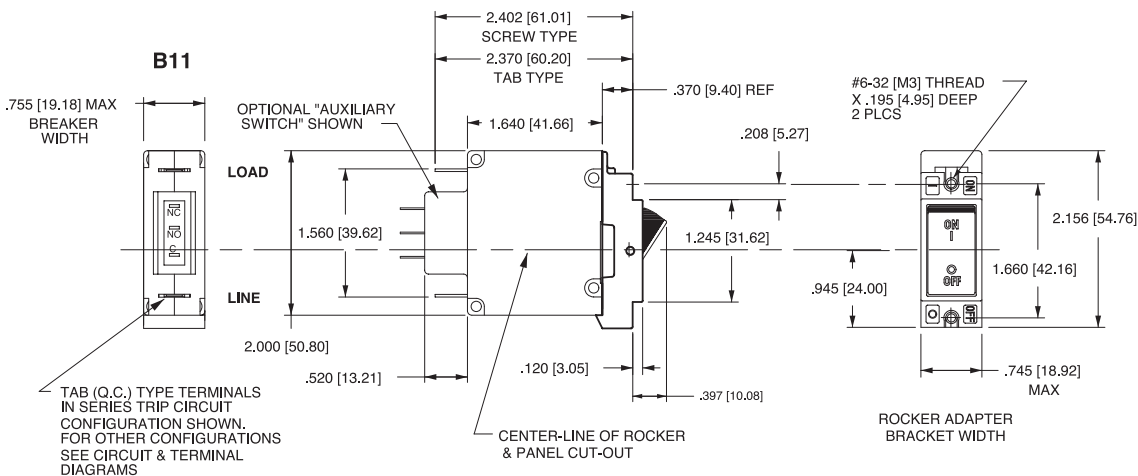

**PUSH-TO-RESET ACTUATOR**



**ACTUATOR SIDE VIEW**  
(SURFACE CONTOURS)



Notes:

- 1 All dimensions are in inches [millimeters].
- 2 For pole orientation with horizontal legend, rotate front view clockwise 90°.
- 3 Tolerance ±.020 [.51] unless otherwise specified.



Notes:

- 1 All dimensions are in inches [millimeters].
- 2 For pole orientation with horizontal legend, rotate front view clockwise 90°.
- 3 Tolerance ±010 [0.25] unless otherwise specified.

REV\_CB\_B\_0812

Компания «Океан Электроники» предлагает заключение долгосрочных отношений при поставках импортных электронных компонентов на взаимовыгодных условиях!

Наши преимущества:

- Поставка оригинальных импортных электронных компонентов напрямую с производств Америки, Европы и Азии, а так же с крупнейших складов мира;
- Широкая линейка поставок активных и пассивных импортных электронных компонентов (более 30 млн. наименований);
- Поставка сложных, дефицитных, либо снятых с производства позиций;
- Оперативные сроки поставки под заказ (от 5 рабочих дней);
- Экспресс доставка в любую точку России;
- Помощь Конструкторского Отдела и консультации квалифицированных инженеров;
- Техническая поддержка проекта, помощь в подборе аналогов, поставка прототипов;
- Поставка электронных компонентов под контролем ВП;
- Система менеджмента качества сертифицирована по Международному стандарту ISO 9001;
- При необходимости вся продукция военного и аэрокосмического назначения проходит испытания и сертификацию в лаборатории (по согласованию с заказчиком);
- Поставка специализированных компонентов военного и аэрокосмического уровня качества (Xilinx, Altera, Analog Devices, Intersil, Interpoint, Microsemi, Actel, Aeroflex, Peregrine, VPT, Syfer, Eurofarad, Texas Instruments, MS Kennedy, Miteq, Cobham, E2V, MA-COM, Hittite, Mini-Circuits, General Dynamics и др.);

Компания «Океан Электроники» является официальным дистрибьютором и эксклюзивным представителем в России одного из крупнейших производителей разъемов военного и аэрокосмического назначения «JONHON», а так же официальным дистрибьютором и эксклюзивным представителем в России производителя высокотехнологичных и надежных решений для передачи СВЧ сигналов «FORSTAR».



## JONHON

«JONHON» (основан в 1970 г.)

Разъемы специального, военного и аэрокосмического назначения:

(Применяются в военной, авиационной, аэрокосмической, морской, железнодорожной, горно- и нефтедобывающей отраслях промышленности)

«FORSTAR» (основан в 1998 г.)

ВЧ соединители, коаксиальные кабели, кабельные сборки и микроволновые компоненты:

(Применяются в телекоммуникациях гражданского и специального назначения, в средствах связи, РЛС, а так же военной, авиационной и аэрокосмической отраслях промышленности).



Телефон: 8 (812) 309-75-97 (многоканальный)

Факс: 8 (812) 320-03-32

Электронная почта: [ocean@oceanchips.ru](mailto:ocean@oceanchips.ru)

Web: <http://oceanchips.ru/>

Адрес: 198099, г. Санкт-Петербург, ул. Калинина, д. 2, корп. 4, лит. А