



PP011-1	X
PP011-2	

LeCroy PP011 Passive Probe Instruction Manual

Revision A – October 2006

Warranty

LeCroy warrants this oscilloscope accessory for normal use and operation within specification for a period of one year from the date of shipment. Spare parts, replacement parts and repairs are warranted for 90 days.

In exercising its warranty, LeCroy, at its option, will either repair or replace any assembly returned within the warranty period to the Customer Service Department of an authorized service center. However, this will be done only if the product is determined by LeCroy's examination to be defective because of workmanship or materials, and the defect is not caused by misuse, neglect, accident, abnormal conditions of operation; or, damaged by attempted repair or modifications by a non-authorized service facility.

The customer will be responsible for the transportation and insurance charges for the return of products to the service facility. LeCroy will return all products under warranty with transportation charges prepaid.

This warranty replaces all other warranties, expressed or implied, including, but not limited to, any implied warranty of merchantability, fitness, or adequacy for any particular purposes or use. LeCroy shall not be liable for any special, incidental, or consequential damages, whether in contract or otherwise.

Corporate Headquarters

700 Chestnut Ridge Road

Chestnut Ridge, NY 10977-6499

Tel: (845) 425-2000 Fax: (845) 425-8967

Internet: www.lecroy.com

© 2006 by LeCroy Corp. All rights reserved.

LeCroy, ActiveDSO, ProBus, SMART Trigger, JitterTrack, WavePro, WaveMaster, WaveSurfer, and Waverunner are registered trademarks of LeCroy Corporation. Other product or brand names are trademarks or requested trademarks of their respective holders. Information in this publication supersedes all earlier versions. Specifications subject to change without notice.

Manufactured under an ISO 9000
Registered Quality Management
System
Visit www.lecroy.com to view the
certificate.



This electronic product is subject to disposal and recycling regulations that vary by country and region. Many countries prohibit the disposal of waste electronic equipment in standard waste receptacles.

For more information about proper disposal and recycling of your LeCroy product, please visit www.lecroy.com/recycle.

PP011-OM-E Rev A
914602-00 Rev A

Safety Information

This symbol appears on the product: 

It refers you to additional information contained in this manual. The corresponding information in the manual is similarly denoted.

To avoid personal injury and to prevent fire or damage to the probe or any products connected to it, review and comply with the following safety precautions.

Connect to properly grounded instruments. This probe is to be used only with test instruments having input connectors with the BNC shield (ring) connected to earth ground.

Connect the probe properly:

Connect the probe to the measurement instrument before connecting the probe to test circuit. Do not disconnect the probe from the test instrument while the input is connected to the test circuit.

Do not connect the probe ground terminal to any point in the test circuit which is at a potential other than earth ground.

Do not apply any potential to the input which exceeds the maximum ratings of the probe.

Comply with the voltage derating curve. When measuring high frequency signals, be sure to comply with the Voltage vs. Frequency derating curve found on page 5.

Do not use in wet or explosive atmospheres.

For indoor use only. This probe is intended for indoor use and should be operated in a clean, dry environment.

Do not use the probe if any part is damaged. All maintenance should be referred to qualified service personnel.



Avoid physical injury. The probe tip is extremely sharp. Use care when handling to prevent injury, including accidental skin puncture.

Use of the probe and/or the test instrument it is connected to in a manner not specified by the manufacturer may impair the protection mechanisms.

Introduction

The PP011 is a miniature high impedance passive probe. Its high input resistance and low capacitance make it ideal for general purpose probing of signals with frequency content from DC through several hundred MHz. The PP011 has a large selection of connection accessories, supplied standard with the probe and available from LeCroy as optional accessories.

The PP011 is designed for use with > 600 MHz LeCroy WaveSurfer oscilloscopes.

Specifications

Electrical Characteristics

Attenuation	10:1 \pm 1%
Input Resistance	10 M Ω \pm 1%
Input Capacitance	9.5 pF
Input Impedance	(see plot on page 5.)
Compensation Range	10 – 20 pF
Bandwidth	500 MHz (-3 dB)

Electrical Ratings



Maximum Input Voltage

Measurement category I: 400 V_{rms},
1250 V transient overvoltage
(see voltage derating curve on page 5)

Measurement category II: 300 V_{rms} CAT II

Pollution Degree

2

Measurement category I is for measurement performed on circuits not directly connected to a mains supply.

Measurement category II (CAT II) is for measurement performed on circuits directly connected to a low voltage installation. This refers to local distribution level, applicable to equipment connected to the mains (AC power source) through a power cable.

Pollution Degree 2 refers to an operating environment where normally only dry non-conductive pollution occurs. Occasionally a temporary conductivity caused by condensation must be expected.

Specifications (continued)

General Characteristics

Operating Temperature	0° to +50° C
Storage Temperature	-40° to +71° C
Altitude, Operating	up to 2000 m (6560 ft)
Cable Length	1.3 m
Weight (probe only)	46 g

**Max. V_{IN} versus Frequency,
Measurement category I**

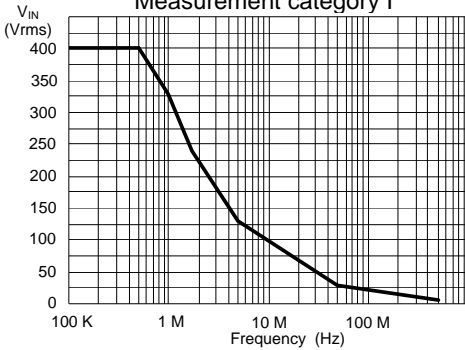

Typical Input Impedance

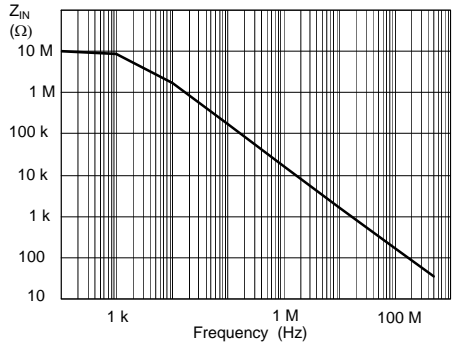

Certifications

This probe is designed to conform to 73/23/EEC + amendment 93/68/EEC Low Voltage Directive (LVD) per the following standards:

- CEI/IEC 61010-031:2002-01 Safety requirements for electrical equipment for measurement control and laboratory use:
 - Part 031: Safety requirements for hand-held probe assemblies for electrical measurement and test.

Connectivity Accessories

LeCroy provides 24 individual accessories for the PP011 probe, which enable reliable connections to any physical requirement. In addition to those provided with the standard probe, several optional varieties are available either individually, or grouped in sets related to specific application needs.

The PK005A series of connectivity accessories are compatible with any LeCroy 5 mm PP011 series probe.

Accessories are shown with the LeCroy part number followed by the description.

Standard Accessories

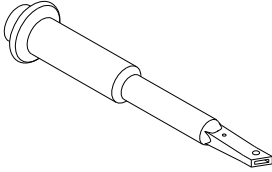

PK1-5MM-101
Sprung Hook

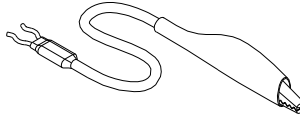

PK1-5MM-102
Standard Ground Lead

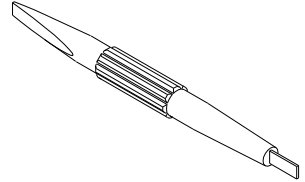

PK1-5MM-103
Adjustment Tool

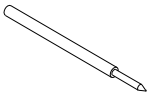

PK1-5MM-104
Rigid Tip, 0.8 mm



PK1-5MM-105
Insulating Cap



PK1-5MM-106
Color Coding Rings (set)

(Not shown)
PP011-OM-E
Instruction Manual

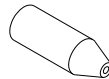

Protective Cap

Optional Accessories

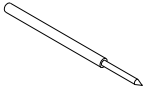

PK1-5MM-109
Spring Tip, 0.8 mm

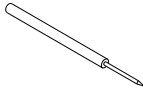

PK1-5MM-124
Spring Tip, 0.38 mm

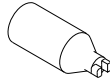

PK1-5MM-108
IC Cap, 2.54 mm pitch



PK1-5MM-118
Ground Spring

Input Adapters and Clips

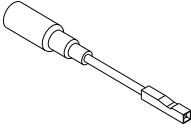

PK1-5MM-111
Single Lead Adapter

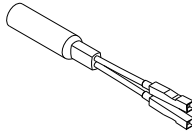

PK1-5MM-112
Dual Lead Adapter

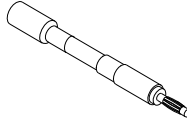

PK1-5MM-116
Adapter, 2 mm plug

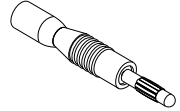

PK1-5MM-117
Adapter, 4 mm plug

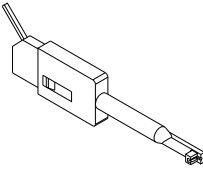

PK1-5MM-113
Pico Hook™

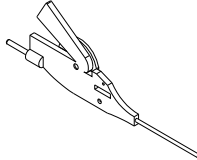

PK1-5MM-114Y
PK1-5MM-114G
Micro Clip, Long

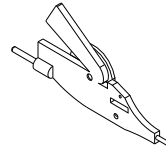

PK1-5MM-115Y
PK1-5MM-115G
Micro Clip, Short

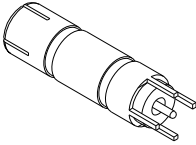

PK1-5MM-107
PCB Adapter

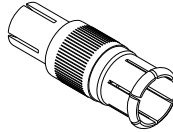

PK1-5MM-110
BNC Adapter
(For low voltage use only $\leq 42 V_{pk}$ AC + DC)

Use of PCB Adapter

The PCB adapter (LeCroy P/N PK1-5MM-107) is intended to be designed into and permanently installed in circuit boards to provide a reliable, high frequency test point which eliminates the need to hand hold the probe.

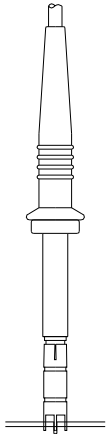

Probe connected using PCB Adapter

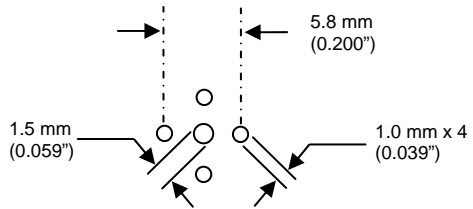

PC Board hole size and pattern

Ground Leads

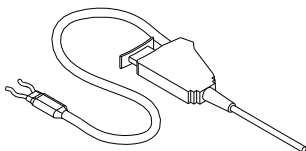

PK1-5MM-119
Ground Lead with mini clip

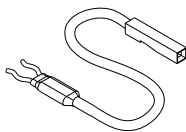

PK1-5MM-120
Ground Lead with 8 mm socket

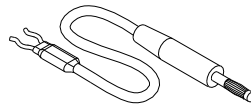

PK1-5MM-121
Ground Lead with 2 mm plug

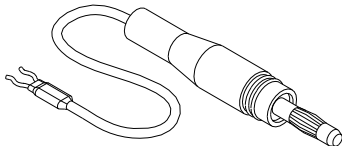

PK1-5MM-122
Ground lead with 4 mm plug

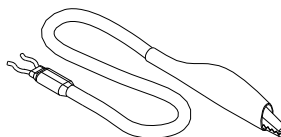

PK1-5MM-123*
High Frequency Compensated Ground Lead

*The PK1-5MM-123 High Frequency compensated ground lead allows operation with long ground lead with minimum signal distortion.

Probe Connectivity Kits

The following kits containing an assortment of probe connection accessories can be ordered directly from LeCroy. Refer to the illustrations on pages 6-9 for identification.

PKIT1-5MM-102 Basic Adapter Kit replaces the common standard accessories, with 1 each of PK1-5MM-110, PK1-5MM-104, PK1-5MM-103, PK1-5MM-108, PK1-5MM-117, PK1-5MM-101, PK1-5MM-102, PK1-5MM-118, PK1-5MM-123; 6 each of PK1-5MM-109; and 5 each of PK1-5MM-124.

PKIT1-5MM-101 Micro Clip Kit adapts the probe for use with 0.5 mm IC lead clips. It contains 1 each of PK1-5MM-115Y, PK1-5MM-115G, PK1-5MM-114Y, PK1-5MM-114G, PK1-5MM-111.

Use and Maintenance

This probe is a high quality, precision instrument. To maintain accuracy and signal fidelity, mechanical shock should be avoided, as well as damage to the cable through excessive bending.

Avoid placing excessive force sideways on the tip.

Should the tip become damaged, it may be replaced by the user using the procedure listed on the last page.

Other maintenance and component replacement should be referred to qualified personnel.

Cleaning

The outside of the probe should be cleaned with a soft cloth dampened with either deionized / distilled water or isopropyl alcohol. Allow the surface to dry completely before returning the probe to service. Never immerse the probe in any liquid.

Probe Compensation

Proper compensation of the probe is required to assure good amplitude accuracy in the dynamic portions of the waveform being measured. LF compensation matches the probe to differences in oscilloscope input capacitance. The LF compensation should always be checked and adjusted as needed when first connecting a passive probe to the oscilloscope input. HF compensation matches time constants within the probe to compensate for normal component tolerances. It is typically not necessary to adjust HF compensation unless the probe is being used with an oscilloscope with large differences in input characteristics than the oscilloscope model it was designed for.

LF compensation is performed by connecting the input of the probe to a low frequency square wave, such as the oscilloscope calibrator signal set to 1 kHz. The compensation is adjusted by rotating the adjustment accessible through the small hole in the center of the housing near the BNC connector. Use the tool supplied with the probe for this adjustment.

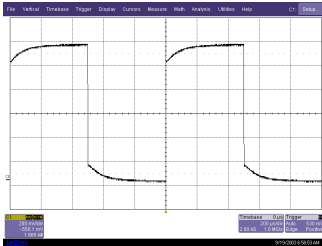

Undershoot

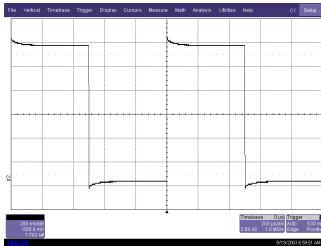

Overshoot

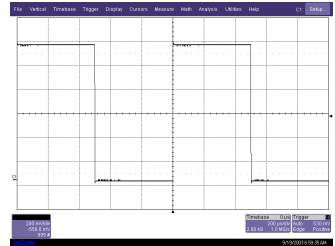

Correct adjustment

Should HF compensation be required, access the adjustments by sliding the black plastic cover off the compensation housing near the BNC connector. A pulse generator with low overshoot and a 300 ps risetime is the required signal source, along with a set of attenuators. The probe must be connected to a terminated probe tip to BNC adapter.

Some overshoot and ring will be present at some settings of V/Div. Adjust the trimmer for the overall best response on all ranges.

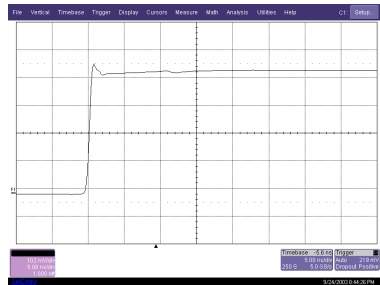

Typical optimum HF adjustment

Tip Selection and Exchange

The PP011 probe is supplied with a rigid tip. The spring tips PK1-5MM-109 (0.8 mm) or PK1-5MM-124 (0.38 mm) combine sharp points with on-axis compliance and can be ordered directly from LeCroy as optional accessories. All three tip styles provide reliable connections under a wide range of physical interconnect situations. While lacking the on-axis compliance feature of the spring tips, the rigid tip has a larger diameter and is more robust when exposed to physical stress at the tip. Select the proper tip for your application needs.

To change the tip or replace it when damaged, carefully grip the outer most portion of tip and pull straight out, along the axis of the probe, using needle nose pliers. Do not attempt to grip the plastic insulator with pliers when removing the tip, as this will squeeze the tip, which will make it difficult or impossible to remove. Do not grip the outer gold plated tube which the tip slides into. With the tip removed, align the replacement tip with the hole and begin the insertion with the pliers. The tip may be fully seated by placing the probe against a hard surface and gently applying pressure.

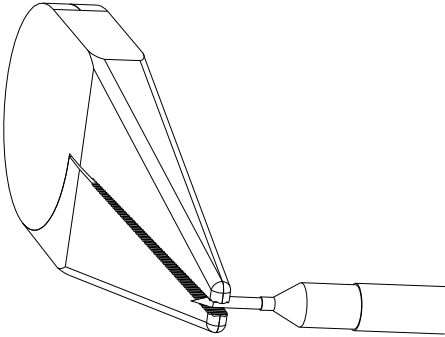

To remove tip, grip the spring-loaded portion of the tip beyond the outer sleeve, and pull straight out.

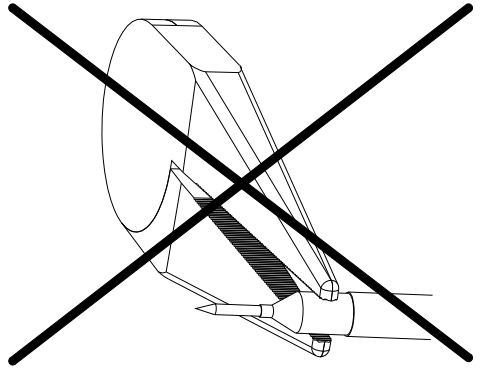

Do not apply pliers to the plastic insulator.

§ § §

Компания «Океан Электроники» предлагает заключение долгосрочных отношений при поставках импортных электронных компонентов на взаимовыгодных условиях!

Наши преимущества:

- Поставка оригинальных импортных электронных компонентов напрямую с производств Америки, Европы и Азии, а так же с крупнейших складов мира;
- Широкая линейка поставок активных и пассивных импортных электронных компонентов (более 30 млн. наименований);
- Поставка сложных, дефицитных, либо снятых с производства позиций;
- Оперативные сроки поставки под заказ (от 5 рабочих дней);
- Экспресс доставка в любую точку России;
- Помощь Конструкторского Отдела и консультации квалифицированных инженеров;
- Техническая поддержка проекта, помощь в подборе аналогов, поставка прототипов;
- Поставка электронных компонентов под контролем ВП;
- Система менеджмента качества сертифицирована по Международному стандарту ISO 9001;
- При необходимости вся продукция военного и аэрокосмического назначения проходит испытания и сертификацию в лаборатории (по согласованию с заказчиком);
- Поставка специализированных компонентов военного и аэрокосмического уровня качества (Xilinx, Altera, Analog Devices, Intersil, Interpoint, Microsemi, Actel, Aeroflex, Peregrine, VPT, Syfer, Eurofarad, Texas Instruments, MS Kennedy, Miteq, Cobham, E2V, MA-COM, Hittite, Mini-Circuits, General Dynamics и др.);

Компания «Океан Электроники» является официальным дистрибьютором и эксклюзивным представителем в России одного из крупнейших производителей разъемов военного и аэрокосмического назначения «JONHON», а так же официальным дистрибьютором и эксклюзивным представителем в России производителя высокотехнологичных и надежных решений для передачи СВЧ сигналов «FORSTAR».



JONHON

«JONHON» (основан в 1970 г.)

Разъемы специального, военного и аэрокосмического назначения:

(Применяются в военной, авиационной, аэрокосмической, морской, железнодорожной, горно- и нефтедобывающей отраслях промышленности)

«FORSTAR» (основан в 1998 г.)

ВЧ соединители, коаксиальные кабели, кабельные сборки и микроволновые компоненты:

(Применяются в телекоммуникациях гражданского и специального назначения, в средствах связи, РЛС, а так же военной, авиационной и аэрокосмической отраслях промышленности).



Телефон: 8 (812) 309-75-97 (многоканальный)

Факс: 8 (812) 320-03-32

Электронная почта: ocean@oceanchips.ru

Web: <http://oceanchips.ru/>

Адрес: 198099, г. Санкт-Петербург, ул. Калинина, д. 2, корп. 4, лит. А