

■ Connectivity...for  
Business-Critical Continuity™

## Central Office DS3 Connectivity

Product Catalog





# TROMPETER NETWORK INTERCONNECT SOLUTIONS

RF connectivity

## OEM Board-Level Components

## Central Office Connectivity

## Outside Plant Products

## Premise/ Enterprise Wiring Closet

Network  
Data  
Source

User  
Edge of  
Network

- PCB to Coax Signal Connectors
- Copper Solutions for Launching High Data Rate Signals On & Off a PCB
- High Density "Octopus" Cable Assemblies

- Building the High Reliability Public Network We Rely on for Voice, Data, and Video
- Coax Box to Box Interconnect Solutions
- Carrier Class Network Connectivity

- Enabling More Connected Bandwidth at the Edge of the Access Network
- Surge Protected for Remote In-Neighborhood Locations
- Bringing DS3 to Places Where T1 is no Longer Sufficient

- POT Handoff and Test Points
- M4Flex™ Wireline Management Solution
- Enabling Connectivity for VDV

Original  
Equipment  
Manufacturers  
& Contract  
Electronics  
Manufacturers

Service Providers  
& Installers

Service Providers

Campus &  
Single-Location  
Premise

## THE TROMPETER DIFFERENCE 2

### CONNECTORS

Continuing Innovation	3
Series 220 Coaxial Standard BNC Plugs	6
Series 250 Coaxial M-BNC Plugs	8
Multi-Pin Coaxial Network Interface Interconnect	11
Best-in-Class Installer Tools	12
Custom Tool Kits	16
BNC Assembly Installer Training & Certification	18
BNC Assembly Video & On-line Training	19
DS3 Cable Bend Radius Tutorial	20
Cable Group Types	21
BNC Crimp Tool Standard & Calibration Technique	22
International Telco Connectors – PosiLock (BT43)	23
International Telco Connectors – 1.6/5.6 DIN	24
In-Series 75-Ohm BNC Adapters	26
Coaxial Transition Connector	27

### PATCHING PRODUCTS

mini WEC0 440 Type Patch Cords	28
Custom Cross Connect Patching Cable Assemblies	29
Rear Cross Connect Jumpers with Tracer	30
Test and Monitor Modules	31

### POINT OF TERMINATION (POT)

Digital Distribution Panels	32
Parallel Network	36

### APPENDIX

Glossary	37
BNC Plug Assembly Instruction	40
Part Number Index	41



## THE TROMPETER DIFFERENCE

Trompeter is the leading provider of carrier-class, central office DS3 connectivity solutions to the telecommunications industry. We design and manufacture a complete line of point-of-termination equipment, cable assemblies, connectors, and installation hand tools for the DS3 coaxial wireline.

### Unmatched Commitment to Reliability

Trompeter is unique in its commitment to supporting central office DS3 reliability. We deliver superior design, engineering, and manufacturing quality. We pursue continuous improvement and innovation. We're dedicated to outstanding customer service. And we provide both on-site and interactive media training support.

We've invested the time and resources to validate our industry superiority through the two most-recognized quality and reliability certifications — ISO 9001:2000 and NEBS.

### Certified Quality Process

Trompeter has been ISO 9001 registered since 1994 and ISO 9001:2000 registered since 2003. The value of this registration to you is the assurance that we have a solid, well-documented quality system in place. Det Norske Veritas (DNV) has certified that we are in compliance with established quality systems and policies.

To earn ISO 9001:2000 registration, we addressed 20 elements of quality processes outlined in the Quality System Standard. An accredited ISO auditor verified, through on-site audits, that we have a well-documented quality system in place that meets ISO 9001:2000 requirements, and that we are in fact working in accordance with the documented system. Our quality system is also certified by multiple customer-specific audits.

Our commitment to quality registration makes us more competitive in the global market and gives you the assurance that you are dealing with a company dedicated to meeting your highest quality and reliability expectations.



### NEBS Compliant and Certified

NEBS stands for the Network Equipment-Building Systems and has several levels for the central office and types of certification. Trompeter is certified at the most-stringent levels — Level 3 and Type 2 for DS3 wirelines. The Bellcore specifications that define this testing are contained in GR-63-CORE, Issue 1, October 1995, and GR-1089-CORE, Issue 2, Revision 1, December 1999.

A partial list of testing requirements includes the effects of airborne particulates, earthquake vibration, low temperature exposure, open flame, high relative humidity, altitude, heat dissipation, fire propagation, mixed flow gas airborne contaminants, acoustic noise emissions, office and shipping vibration and drop, and illumination clarity. The testing of these environmental impacts on performance is over and above the stringent electrical and data rate signal requirements.

Meeting the NEBS standard is now a condition of providing equipment for the public network, particularly the central office, where reliability is critical to uninterrupted service levels for data and digitized voice. Trompeter is the primary provider of telco BNCs for DS3 central office applications.





## CONTINUING INNOVATION MEETING THE CENTRAL OFFICE RELIABILITY CHALLENGE

Our RBOC, CLEC, and ILEC customers tell us that the single leading cause of central office network outages is **incomplete connector mating**. Because the pressure to extract more and more bandwidth from already densely-packed and dimly-lit facilities continues to increase, we went to work to find a way to help installers and inspectors get every connector mating right the first time.

### The *SureNotch*<sup>™</sup> BNC Plug – Provides Immediate Visual Confirmation of a Correct Installation

When you deploy the Trompeter BNC with the *SureNotch* BNC plugs\*, your installers and inspectors will have immediate and reliable visual confirmation that they are securely mated to the equipment jack.

We've added dual opposing notches on the rear of the plug that align with the locking end of each J-slot in the BNC housing. We've also added a black washer to the rear surface of the plug to provide a high visual contrast to the nickel finish. Most telco network element "box builders" orient the lugs on DS3 ports north and south. When the notch on the rear of the plug is in the 12 o'clock position, installers can be sure that they have fully rotated and locked the connector in place, and inspectors can quickly see that the plug and jack are securely mated.

The *SureNotch* BNC plug is a patented, "no extra cost" solution for improving installers' ability to connect it right the first time. It also dramatically reduces the need for secondary inspections of wireline connections and speeds up the diagnosis of network performance problems at the central office.

### Reliability Through Superior Products, Tooling , and Training

No other supplier of BNCs to the telecom industry has the track record of continuous improvement to this proven component. From the introduction of angled plugs to improve cable management, reduce cable strain, to the M-BNC to enable greater density in central office environments, to the *SureNotch* plug, Trompeter's accomplishments in connector innovation to improve the reliability of the public network are unmatched.

Our commitment to central office reliability extends beyond continuous improvement to our rock-solid connector technology and engineering. We provide a



complete line of **installer tools** (see page 12) to ensure that the cable end attachment to the plug is as high-quality as the component itself. And we support your installers with comprehensive **in-person, video, and Web-based training**, at no additional cost, leading to Trompeter BNC Interconnect Installer Certification (see page 18).

### Trompeter BNCs are the Clear Market Leader in the Central Office

Trompeter BNCs are the connector of choice in over two-thirds of all ILEC central office installations, and are the most-specified connector by CLECs. Our superior product and tooling reliability, ongoing commitment to product improvement, and dedication to installer training are the reasons why more Trompeter connectors are in the central office than all other brands combined.

*\* Available on the Trompeter 220 and 250 Series for 025 (734 cable) and 026 (735 cable) cable groups, inclusive of straight, 45-degree and right-angle versions.*

## YOUR DS3 PERFORMANCE ADVANTAGE

**20 Reasons** Why the Trompeter UPL220-026 BNC Connector Is the Best in its Class!



**NEW!** Patented *SureNotch* provides positive visual indication of correct BNC plug installation. Black washer provides visual contrast.

# THE BEST AND MOST WIDELY-USED BNC CONNECTORS ARE NOW BETTER THAN EVER.

Trompeter's BNC connector series is designed to accommodate specific manufacturer cable models. Our tool-crimp BNC plug comes in 26 cable groups to match over 2,000 cables. We carefully analyze cable samples and physically test our connectors and cable-end tooling to ensure that you receive the most reliable termination in the industry. Trompeter's superior mechanical design ensures mating integrity by incorporating features you will not find in other connector designs. Our pursuit of continuous improvement ensures that you will always get the best BNC available for telco applications.

Trompeter BNCs are built to tough performance standards with extremely close tolerance. Our exclusive design features include:

- Connector bodies that are made of top-quality brass with a bright nickel plating
- Our outer conductor springs are fully enclosed for high lateral pull strength
- Heat-treated, beryllium-copper female center socket and brass male contacts have 50-millionths of an inch of gold plating
- All dielectrics are made of machined or molded solid Teflon™.

## Superior Performance

Article under test is UPL220-026 (BNC plug)  
on Lucent-735A Cable (10 inches in length)

### RETURN LOSS



### ATTENUATION aka INSERTION LOSS



## SERIES 220 COAXIAL STANDARD BNC PLUGS

### Straight, 45° and 90° BNC's

Trompeter 45° and 90° BNC's provide the ultimate combination for routing and cable management in tight spaces. Only Trompeter offers 45° and 90° BNC's with superior designs at considerable cost savings over other brands. The convenience of standard cable stripping dimensions and tooling gives you the connecting edge.

### The Tool Crimp Terminated BNC

Three pieces comprise a tool crimp BNC: body, center contact and crimp sleeve. The contact pin is crimped onto the coax conductor and jacket/braid is secured by crimping the crimp sleeve.

### Application Note

The 45° and 90° BNC connectors are specifically designed for DSX applications where large quantities of cable are routed through, in and around tight areas. Cabling in the installations typically requires a bend radius of more than 2.5 times the cable's outer diameter.

Over-bending can cause cable damage, signal degradation and change the cable's electrical characteristic. Combinations of straight, 45° and 90° connectors allow for minimal cable bending, leading to better attenuation properties and increased system reliability.

XXX = Cable Group, see Page 21

**NEBS LEVEL 3 TYPE 2 COMPLIANT  
AND TEST CERTIFIED**

### UPL220-XXX

Straight, 75-ohm BNC plug, tool crimp



### UPLFF220-XXX

45°, 75-ohm BNC plug, tool crimp



### UPLR220-XXX

90°, 75-ohm BNC plug, tool crimp





# SERIES 220 COAXIAL STANDARD BNC PLUGS

## UPL220 BNC Plug BNC Bulk Packaging

Trompeter offers 220 Series BNC plugs bulk packed in convenient vacuum-formed plastic trays. Bulk packaging is perfect for OEM and high-volume, on-site installations. Bulk packaging in bags also available.

- 50 body assemblies
- 51 crimp sleeves
- 52 center contact pins
- Assembly instructions

Order bulk packaging using the following format:

Example: UPL220-025 / T50



## NEBS LEVEL 3 TYPE 2 COMPLIANT AND TEST CERTIFIED

Individual voice channels are digitized as soon as they enter the Central Office - at that point they are just data files and could be DSL or other IP Internet-type data.

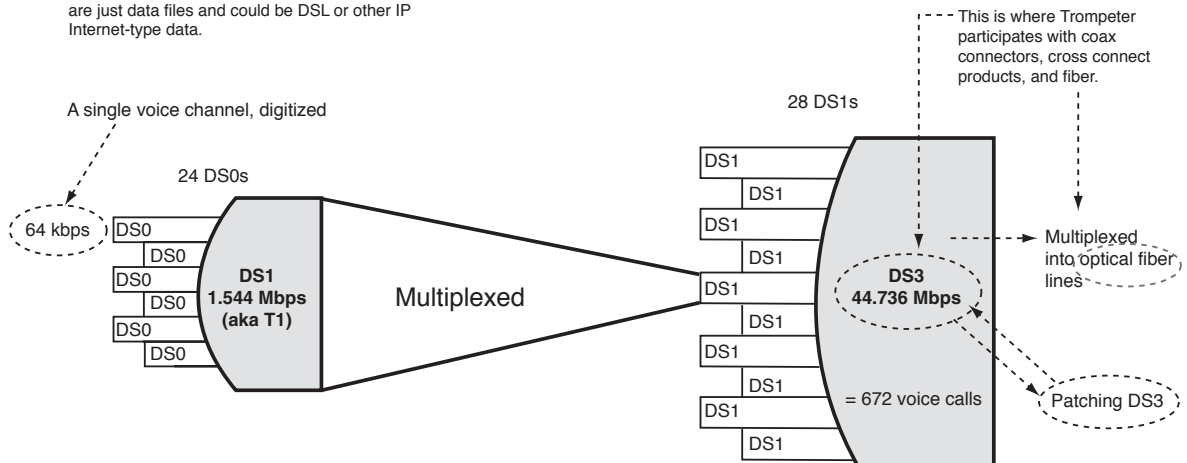

## SERIES 250 COAXIAL M-BNC PLUGS

The M-BNC 250 Series connectors are designed specifically to allow higher interconnect density while preserving the positive characteristics of the Trompeter full size BNC.

Alternative products such as the SMB, while sometimes offered in true 75-ohm, do not have a bayonet locking feature. Some have no interface locking feature and others use “posilock” technology, more costly and less well known in the telco space than the bayonet locking system. Also, SMB connectors are not typically designed to be field-terminated as are both the BNC and M-BNC.

### UPL250 Series



### UBJ250 Series



# SERIES 250 COAXIAL M-BNC PLUGS

## How the M-BNC Came to Be

As the leading BNC supplier to the telecom industry, Trompeter's technical staff routinely interfaces with senior level managers at the larger service providers in North America. When the central office congestion issue surfaced repeatedly in these discussions, our engineering team suggested an answer to more efficient floor space utilization — enable more devices (and more interconnects) per rack by inventing a smaller connector. Trompeter delivered 100% on our customers' desire for a reduced footprint and all the installation, tooling, and performance characteristics of the standard telco BNC. Our customers placed high emphasis on these attributes:

**Same crimp and crimp design** — Trompeter's standard BNC and M-BNC are field-terminated with the same cable strip tools, contact crimp tools and crimp sleeve crimp tools — proven effective over 30 years of use involving an estimated 50 million connectors.

**Same installation tooling** — Trompeter tooling for DS3 cable termination is truly best-in-class and is used by a large base of trained telco installers. Identical tooling means easy migration to the M-BNC.

**Same footprint on the jack side as existing high-density connectors** — Since many high density applications such as routers use SMB or SMZ jacks, the M-BNC series jacks have been carefully designed to use the same footprint on the printed circuit board, another enabler of easy implementation.

**Mate/De-mate tool** — Trompeter has designed and manufactured a removal tool that is uniquely fitted to enable installation and removal of the M-BNC in tight spaces without resorting to pulling on the cable itself. This tool is modeled after the BNC-removal tool and uses the same materials and design.



Trompeter is also committed to partnering with original equipment manufacturers who specify and purchase the jack side of the connector. Service providers specify and purchase the plug (male side) of the BNC, and the OEMs design in and purchase the jack (female) side. This requires agreement from both parties on the series to be used, resulting in an interface specification or convention for the connectors to be mated.

The M-BNC enables 40% more interconnects per given area while retaining all the critical-to-reliability attributes of the standard BNC. The M-BNC series is now available in straight and right angle plugs, bulkhead cable jacks, and straight and right angle PCB mounted jacks. There is also a PCB edge-launch jack using surface mount technology. The leaded circuit board jacks are designed to maintain the same “footprint” (mounting holes) as the SMB series to allow easy implementation of the MBNC series into current circuit board designs. This allows for easy retrofit activity, making upgrade to the new series simple, and eliminating the expense of PCB redesign.

BNC means “Bayonet Neill-Concelman” and is named for Paul Neill, who developed the N series connector at Bell Labs, and Carl Concelman, who developed the C series connector.

## SERIES 250 COAXIAL M-BNC PLUGS

All products in the M-BNC 250 series are 75-ohm

		Final Plate	Bulkhead Mount
UPL250-026	Straight plug M-BNC	ni	n/a
UPL250-025	Straight plug M-BNC	ni	n/a
UPL250-014	Straight plug M-BNC	ni	n/a
UPL250-009	Straight plug M-BNC	ni	n/a
UPLR250-026	90° plug M-BNC	ni	n/a
UPLR250-025	90° plug M-BNC	ni	n/a
UBJ250-026	Bulkhead cable jack	ni	yes
UBJ250-025	Bulkhead cable jack	ni	yes
UBJ258	M-BNC jack to M-BNC jack adapter	ni	yes
UAD258	Barrel adapter	ni	no



Same as the telco standard BNC except smaller. Enables 40% more interconnects in the same area.



# MULTI-PIN COAXIAL NETWORK INTERFACE INTERCONNECT

## Octopus “Off-PCB” Interconnect Solution

Trompeter’s Octopus interconnect is designed for applications where higher PCB density with coax cable connectivity to the network is desired. The Octopus moves the network connectivity jacks “off” the PCB to the rear of the network rack to which the OEM equipment is bolted.

The Octopus assembly mates with an industry-standard latching header on 0.100” centers on the PCB side. Each header handles 24 coax lines. On the opposite side, each coax cable terminates into jacks mounted on a 23” 1RU rack panel; one panel can accommodate up to 96 M-BNC jacks or 72 standard BNC jacks.

Standard S-parameter testing of the Octopus interconnect indicates excellent performance up through DS3 data rates.



## The Central Office Distributes Digital Service Level 3 (DS3) Signal

A DS3 line is a circuit that is used by telephone companies in the CO and increasingly in the outside plant. A DS3 line transmits data and digitized voice at a rate of 44.736 Mbps. It serves as a transport for 28 T1 circuits, which can be configured to supply up to 672 DS0 circuits (voice channels). Telecommunications customers use DS3 circuits as private lines to connect data services from one geographic location to another, or to transport large amounts of dial tone to the premise. DS3 circuits are also used to connect directly to a long-distance company for broadband WAN service. Some companies are now selling fractional DS3 lines.



# BEST-IN-CLASS TOOLS TO PREPARE THE CABLE END

## Powered Cable Stripper

This low-cost, portable hand-held (less than 2.25 lbs) cable stripper delivers production quality performance and up to 250 strips per charge (7.2V Ni-Cad battery). The replaceable, 3-level cutter head is pre-set to strip your coax cable for Trompeter's 220 and 250 Series plugs. The cutter head has adjustable depth cutter blades for precision tuning. Precision ground, tool steel blades (hardened to Rockwell 64) give you up to 15,000 strips. Rapid charger/reconditioner recharges Ni-Cad battery in only 1.5 hours. 1 year warranty.



Powered  
Cable  
Stripper

Cable  
Cutting  
Tool

Cutter  
Heads

## Manual Cable Stripping Tool

ST1 Tool only – requires blade cassette listed  
STC-F Cassette (for tool crimp BNC connectors)

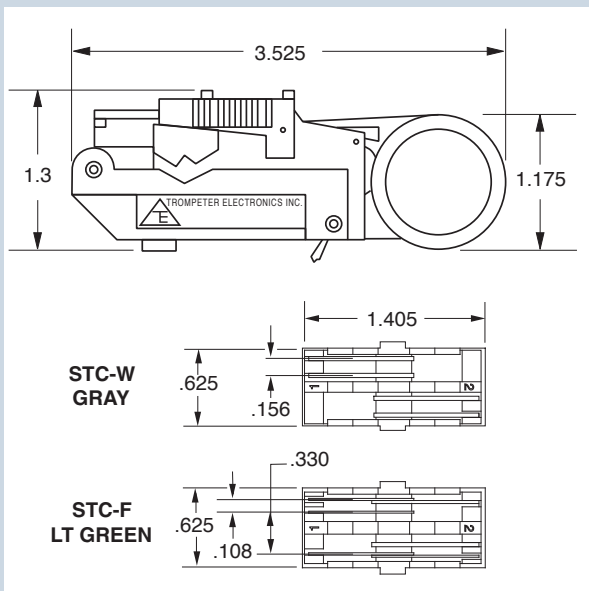

## Cable Cutting Tool

700-0024

Designed to cut coax cables without compressing dielectric or damaging center conductor

## Cutter Head Guide

Coaxial Cable Outside Diameter	3-Blade Cut
.070-.110	C24T3A
.160-.215	C24T3B
.190-.230	C24T3C
.235-.270	C24T3D
.300-.430	C24T3E
.110-.160	C24T3I
.271-.305	C24T3U

## Powered Cable Stripper Kits

Comes with: 1 driver, 1 Ni-Cad battery pak, 1 cutter head, 1 rapid charger/reconditioner and 1 carrying case.

Part Number Example:

	Stripper/Cutter Head
For cables: 728 / 734A / RG-59	BCCS/C24T3D
For cables: 735A / KS19224L2	BCCS/C24T3I

## Additional Accessories

AC Driver and Power Unit Only (no cutters)	ACS
Rapid Charger / Reconditioner	BRCC
Gear Train Assembly Only	BCS-DO
Ni-Cad Battery Pack	RBP
AC Power Converter	ACC

## BEST-IN-CLASS TOOLS TO INSTALL THE CONNECTOR

### Center Contact Crimp Tool

010-0098



### Multi-Point Indenter

The recommended Trompeter multi-point indenter tool for telco-grade BNC connectors and patch plugs is the 010-0098.

### CT4L Ergonomic Frame only

(die not included, for crimp dies see chart)



### Initialized Embossed Dies

Trompeter offers a personalized embossed CD3-19 die. One side of the die face embosses 734 and 735 respectively, to represent the cable types. The other die face embosses up to 4 pre-selected letters/numbers of your choosing. The base part number is 010-0129-xxx\* and is accompanied by your personalized “dash number”. Call factory for availability. (xxx = replace with dash number.) Requires a one time setup charge.

Preferred Crimp Die  
CD3-19



### Benchtop Crimp Tool

CTB-1/CD5A-1



### Benchtop Crimp Tool

CTB-1/CD5A-1

Manufactured to Trompeter engineering specifications, the CTB-1 is designed for production crimping assignments for coaxial cable connectors such as the BNC. The base unit include a footswitch and one pair of self-aligning parallel hex dies as standard equipment. Ships with our CD5A-1.

### Die

CD5A-1

Manufactured to Trompeter engineering specifications and for cables with half-inch crimp sleeves. Designed for hex crimp sleeve diameters .178” and .255”.



# BEST-IN-CLASS TOOLS TO TEST THE RESULT

## BNC Coax Assembly Tester

Designed to test for the proper assembly of BNC plugs with coax cables. Tests for center contact pin height and continuity (short or open). Mini WECO continuity test adapter can be ordered (sold separately).

- On/off switch to protect battery life
- Compact design
- Pass/Open/Short LED indicators
- One test required for testing remote cable runs
- Easy to follow instructions
- Complete with terminator, case and 9V battery
- Also available for M-BNC (see part number below)



## Coax Cable Assembly Connector Test Set

75 ohm BNC Plugs  
010-0133

75 ohm M-BNC Plugs  
010-0208

## mini WECO Adapter: Continuity Tester

(sold separately)  
105-1885

## BNC Plug Pin Height Gauge 010-0158

Mitutoyo mechanical pin height gauge for BNC plugs to verify pin height.

With special stainless steel BNC back lugs for superior wear properties.



## BNC Removal Tools



## Connector Removal Tools

Tool	Type	Length
RT1XL	Straight BNC	22.00"
RT1L	Straight BNC	12.00"
RTR-1L	Right Angle BNC	12.00"
RT1S	Straight BNC	6.00"
RT1SS	Straight BNC	3.75"
RT4L	Straight M-BNC	12"
RTR-4L	Right Angle M-BNC	12"
RTC-1L*	Straight BNC	12"
RTC-4L*	Straight M-BNC	12"

\* Insulated coating

## CUSTOM TOOL KITS **SMALL TOOL KIT**



Prefix	Crimp Die	Crimp Die Selection	Manual Cable Stripper	Center Pin Crimper	Manual Cable Cutter	Pin Gauge or Tester	Removal Tool
	Empty =	0					
	CD3-1 =	A		A = 010-0088		1 = 010-0108	A = RT1L
	CD3-2 =	B		B = 010-0097		2 = 010-0133	B = RT1S
	CD3-3 =	C		C = 010-0098		3 = 010-0208	C = RT1SS
	CD3-5 =	D	1 = ST1/STC-F	D = 010-0055	1 = 700-0024		D = RTR-1L
	CD3-19 =	E	0 = Empty	E = 010-0080	0 = Empty		E = RTR-4L
	CD3-21 =	F					
	CD3-22 =	G					
	CD3-23 =	H					

### Small Tool Kit Part Number Configurator: (choose number or letter from above chart)

	Crimp Die				Manual Cable Stripper	Center Pin Crimper	Manual Cable Cutter	Pin Gauge or Tester	Removal Tool
	#1	#2	#3	#4					
TS	E	F	O	O	1	B	1	1	A
	CD3-19	CD3-21	Empty	Empty	ST1/STC-F	700-0024	700-0024	010-0108	RT1L

**CT4L INCLUDED IN KIT, BUT NOT SHOWN IN PART NUMBER.**

Only the number 0 (zero) is to be used. The letter "O" is not to be used in this part number system. The letter "Z" can be used in any position to specify item not included above. This custom addition must be ordered as a separate line item.

# CUSTOM TOOL KITS **ROLLABOUT™** KIT



Whether you're a local or long-distance road warrior, you can now carry all your tools conveniently and securely with the new *Rollabout™* custom tool kit.

*Rollabout* is a new hard-shell case equipped with custom-fitted foam encasing to house and protect each tool, smooth-rolling wheels, and a retractable handle. It's also designed to fit comfortably inside standard overhead storage bins on commercial airliners.

*Rollabout* replaces the medium and large tool kits in Trompeter's line of installation tooling products. Each kit is built to customer order. The *Rollabout* case may also be purchased separately for installers with existing tools. Use the tool matrix and configurator below to specify your *Rollabout* kit just the way you need it!

Prefix	Crimp Die	Crimp Die Selection	Powered Cable Stripper	Cutter Head	Center Pin Crimper	Manual Cable Cutter	Removal Tool	Tester	Pin Height Gauge
	Empty =	0		A = C24T3A					
	CD3-1 =	A		B = C24T3B	A = 010-0088		A = RT1L		
	CD3-2 =	B	1 = ACS	C = C24T3C	B = 010-0097	1 = 700-0024	B = RT1S	1 = 010-0108	1 = 010-0158
	CD3-3 =	C	2 = BCCS	D = C24T3D	C = 010-0098	0 = Empty	C = RT1SS	2 = 010-0133	0 = Empty
	CD3-5 =	D	3 = BCS	E = C24T3E	D = 010-0055		D = RTR-1L	3 = 010-0208	
	CD3-19 =	E	4 = DPCS	I = C24T3I	E = 010-0080		E = RTC-1L		
	CD3-21 =	F		U = C24T3U			F = RTR-4L		
	CD3-22 =	G							
	CD3-23 =	H							

## Large Tool Kit Part Number Configurator: (choose number or letter from above chart)

	Crimp Die				Powered Cable Stripper	Cutter Head			Center Pin Crimper	Man. Cable Cutter	Removal Tool	Tester	Pin Height Gauge
	#1	#2	#3	#4		#1	#2	#3					
TL	E	F	G	G	2	I	U	0	C	1	A	1	1
	CD3-19	CD3-21	CD3-22	CD3-22	BCCS	C24T3I	C24T3U	Empty	010-0098	700-0024	RT1L	010-0108	010-0158

**CT4L INCLUDED IN KIT, BUT NOT SHOWN IN PART NUMBER.**

Only the number 0 (zero) is to be used. The letter "O" is not to be used in this part number system. The letter "Z" can be used in any position to specify item not included above. This custom addition must be ordered as a separate line item.

## BNC ASSEMBLY **INSTALLER TRAINING & CERTIFICATION**

### Ten Reasons For Installer Training and Certification

- 1 Ensure consistent knowledge, skills, and technique in the field
- 2 Reduce installer and tooling-related installation errors
- 3 Educate installers on the consequences of incorrectly-assembled BNCs
- 4 Improve overall system reliability
- 5 Improve transmission line signal/noise
- 6 Achieve lower installed cost
- 7 Providers are requiring installer certification
- 8 Encourages good workmanship
- 9 Minimizes installer variation
- 10 It's offered **free of charge** as a service from Trompeter to the installer community



### Our Exclusive Commitment to Installer Training

Trompeter's commitment to central office reliability extends beyond our rock-solid technology and best-in-class installer tools to include our exclusive BNC Installer Training and Certification Program.

Installers can earn the distinction of Trompeter certification through our on-site training, which is designed to:

- Reduce transmission noise from improperly-terminated connectors
- Reduce system downtime in the field
- Increase installer productivity
- Increase the reliability and consistency of terminations in the field
- Reduce overall installation costs

The course is customized to your application, and covers correct cable preparation techniques, proper selection and use of tools, and high-quality methods for terminating cable assemblies





# BNC ASSEMBLY VIDEO & ON-LINE TRAINING



## Now You Can Equip Every Installer With Convenient Training-On-Demand

Trompeter has produced a 13-minute BNC Assembly tutorial to reinforce the essential assembly techniques we teach in on-site training.

Step-by-step procedures for preparing the cable end, installing the crimp sleeve and center pin contact, inserting the pin contact into the connector body, and crimping the sleeve to achieve secure mechanical attachment are visually demonstrated.

The tutorial is available on CD-ROM for go-anywhere convenience. It's also available as a MPEG download on the home page of Trompeter's web site. Go to [www.trompeter.com](http://www.trompeter.com) and click on the "MPEG" link or the "ZIP" link to download the video onto your computer. Be patient — this is a large file!



Available in English and Spanish voice over.

## DS3 CABLE BEND RADIUS TUTORIAL

The conventional copper-based wiring of today's telephony central office is a substantial user of 75-ohm BNC connectors for the termination of coaxial cable transmission lines.

Usage of copper based coaxial cable still carries significant advantages in cost, ease of use, high data rate signal clarity, and bandwidth. Despite the huge capacity available in fiber optic technology and continued attempts (such as bonded pairs) to utilize the enormous installed base of twisted pair copper, coax is still a favorite and proven technology with very low risk and extremely low line failure rates. It is also the primary in-facility transmission line for video data rates.

However, as line density has gone up, so has the amount of cable that is attached to the backs of these bays. There are two problems that this higher density creates that can impact reliability.

### Cable Weight Force Can Degrade Connector Mating

First, the weight of the cable itself acts as a lateral force on the BNC connector. If a low cost connector is used (usually manifested by the substitution of inferior materials), the constant lateral downward pressure can, over time, deform the coupling wave washer, and degrade mating force unique to the BNC style connector.



Using a high quality BNC connector eliminates this risk. This downward lateral force on a straight BNC connector is more significant the greater the cable “fall” and cable diameter, and top bay equipment is more subject to this simple gravity impact than is the lower bay equipment.

### Excess Cable Bend Damages Dielectric Spacing

A second issue is the radius or bend that the cable itself takes in making the transition from horizontal (in line with the BNC jack) to the vertical (gravity). To the extent that the cable deforms over time, this radius reduction can damage the critical dielectric spacing in the cable at the bend and negatively alter transmission line performance. The higher the frequency, the more pronounced this effect becomes. See Cable Bend Radius Examples illustration. All of the above-mentioned problems are exasperated by the increasing use of lower loss cable for longer runs or higher bandwidth and frequency capabilities. This all translates into more weight.

One simple solution is to utilize a 90° or 45° connector to solve the issue of degrading cable bend radius due to weight. Bend relief “boots” to help limit the lower radius limit can also help.

Yet another result of this density problem is the “curtain effect” or blockage of airflow circulating in the rack units. This blockage of proper airflow has potentially serious service life-reducing impact on sensitive electrical equipment. Thermal degradation of electrical equipment due to insufficient air movement and radiant cooling is well documented. Suffice it to say air movement is good, and blockage of air movement from a curtain of hanging cable is not.

### 45° Connectors Solve Both Problems

Perhaps a more elegant solution to the issues raised here involves the use of 45° BNC's (see “Best” in visual side view example below), which typically cost slightly less than a 90° BNC. Using 45° connectors, each plug can be nested over the next, directing the associated cable horizontally to the side of the rack unit. From there, the cable can be tied off to the rack, which removes the weight strain, regardless of the height of the equipment in the bay. Most importantly, the approach allows maximum uninterrupted airflow throughout the cabinet, allowing full radiant cooling.

# CABLE GROUP TYPES

Cable	Cable Group #	Hand Held Stripper Crimp Tool	12 pt. Center Contact	Crimp Die
<b>AT&amp;T/Lucent</b>				
<b>734 Type</b>				
734A/D	-025	ST1/STC-F	010-0098	CD3-19
<b>735 Type</b>				
1735A	-026	ST1/STC-F	010-0098	CD3-19
735A/C	-026	ST1/STC-F	010-0098	CD3-19
728	-016	ST1/STC-F	010-0098	CD3-2
<b>Belden/CDT</b>				
<b>734 Type</b>				
734D1	-025	ST1/STC-F	010-0098	CD3-19
<b>735 Type</b>				
735A1	-026	ST1/STC-F	010-0098	CD3-19
<b>Additional Types</b>				
YR28314	-009	ST1/STC-F	010-0098	CD3-19
YR39667	-009	ST1/STC-F	010-0098	CD3-19
<b>CommScope</b>				
<b>734 Type</b>				
734C1	-025	ST1/STC-F	010-0098	CD3-19
734C1P	105-1313*	ST1/STC-F	010-0098	CD3-19
<b>735 Type</b>				
73501P	-026	ST1/STC-F	010-0098	CD3-19
<i>* Call factory, dash number is model specific.</i>				
<b>Judd</b>				
<b>734 Type</b>				
C1401053	-025	ST1/STC-F	010-0098	CD3-19
<b>735 Type</b>				
C1401064	-026	ST1/STC-F	010-0098	CD3-19

Run lengths vary in the telco central office. Coax cable needs to be sized to accommodate this so that attenuation limits are not exceeded. 734-type cable is usually capable of run lengths up to 450 feet and 735-type cable is capable of run lengths up to 225 feet. Cable attenuation expectations are provided by the cable manufacturers and are expressed in dB per 100 feet at various frequencies. For the DS3 coaxial line in the telco CO, we recommend using 200 MHz as the upper frequency limit for the typical DS3 line.

## BNC CRIMP TOOL STANDARD & CALIBRATION TECHNIQUE

### [Trompeter Crimp Sleeve Tool Calibration, Testing For Tool Capability, And Recalibration](#)

Trompeter is a “world class” supplier of crimped RF connectors to the telephone central office market segment. Many of the Trompeter crimp designs involve crimp sleeves to secure the connectors to the coaxial cable. These crimp sleeves must be crimped with a tool that is in calibration. Whether a tool is in calibration or not is determined by time or test.

Extensive testing by Trompeter has proven that a tool which does not meet a minimum crimp force criteria can cause a significant reduction in the retention of a connector.

**Time Calibration** — in the event that an installer does not have a proper die set to perform the test method to determine whether a CT4L is in proper calibration, the default is a time calibration (12 months from last “factory” calibration). Factory calibrations can be done at Trompeter or at a licensed and certified 3rd party calibration facility. Currently, Trompeter has authorized only one other calibration house and that business is Micron Inspection & Calibration Services. MICS 4308 North George Street, Manchester, PA 17345. Contact: Avyayam Dave Ph: 717-266-5775.

**Test Calibration** — at any time, a Trompeter CT4L tool may be tested for proper calibration by inserting a CD3-19 die in the tool and crimping the UPL220-026 BNC connector sleeve. The connector must be on 735 cable for the test to be valid. After crimping, the measurement of the flat in two of three places must be a maximum of 0.190 inches. If this is true, the tool may be used for another 500 crimps, after which time the test shall be repeated. If, after any of the test crimps, the tool is discovered to not pass the dimensional test, the tool is considered to be non-compliant and shall be removed from service. The tool can be then sent to Trompeter or the Trompeter approved third party for adjustment and calibration, after which time the cycle is restarted.



Tool Calibration Verification Guide 010-0179

### [Trompeter Center Contact Tool Calibration, Testing For Tool Capability, and Re-calibration](#)

Multi-point indenters should be inspected every 6 months for proper operation. The procedure for inspecting the tool is Trompeter Gage Specification, TGS-15 (Calibration Procedure for Trompeter Center Contact Crimp Tool). This procedure requires the Trompeter gage 010-0101. If the tool fails to meet the minimum criteria under the test, then the tool is to be discarded (there is no adjustment mechanism).

**Inspection Criteria** — If a visual inspection with the naked eye indicates that there are the appropriate number of contact points in the exterior sidewall of the center pin contact after crimping (metal must be moved), the crimp is considered good.

# INTERNATIONAL TELCO CONNECTORS

## PosiLock (BT43)

### Coaxial SMZ PosiLock Connectors

All True 75-ohm

As globalization continues to transform the telecom industry, Trompeter has brought its engineering and manufacturing superiority to its line of carrier-class SMZ PosiLock connectors, the UPL143 (also known as the BT43).

The BT43 connector is an industry standard for central office E3 coaxial connectivity in European, Asian, South and Central American markets, and is being used more in North America as central office equipment from offshore manufacturers gains penetration. Trompeter's UPL143 plugs are available in straight and 90° configurations.

The UPL143-XXX straight plug accommodates cable diameters ranging from .178 to .290.

The UPLR143-XXX right-angle plug design includes a gold-plated center pin that is crimped to the center wire of a coaxial cable and then inserted into the bottom of the connector body where it engages into an internal socket, completing the interconnect path with precision coaxial spacing for a true 75-ohm impedance condition.

The UPL143 Series plugs are terminated with the same hand tools, strip dimensions, and installer training as Trompeter's telco-grade M-BNC and standard BNC connectors.



### 143 Series Connector Specifications

#### Electrical Data

Characteristic Impedance	75-ohm
Frequency Range	0-3 GHz
VSWR	1.22
Working Voltage	1,500 VRMS at sea level 300VRMS at 65,000 feet
Temperature Range	-40°C to +85°C
Insulation Resistance	10,000 MegaOhm min
Contact Resistance	4.0 milli-ohms

#### Material

Body	Brass per ASTM-B16
Crimp Sleeve	Brass per ASTM-B16
Socket Contact and Spring Fingers	BeCu per ASTM-B196,197
Pin Contact	Brass per ASTM-B16
Dielectric	PTFE



## INTERNATIONAL TELCO CONNECTORS 1.6/5.6 DIN

In today's congested central office, space is precious. Being able to provide more throughputs in a given panel or bay is becoming more important to OEM designers of telco hardware and their customers. Trompeter's 110 Series connectors are made to the DIN 1.6/5.6 interface specification. This connector style is used in the European and South American telecom central offices for DSX cross connects and is beginning to be used and requested in the North American market.

Trompeter's 110 Series connectors are 30% smaller than the standard BNC currently used for the DS3 central office termination. With this space savings, 72 interconnects can be placed in the same 1RU panels as 52 BNCs.

The 110 Series includes cable plugs, cable jack, U-Link for connecting two jacks, and BNC to DIN adapters. Trompeter's 110 Series works with all the cables currently in use in the central office environment and can be manufactured to accommodate any coax cable changes.

The 110 Series delivers the same superior quality performance as Trompeter's 220 Series BNCs. Tooling and practices are the same as for the 220 Series.

Note: \* = For specific cable manufacturer and model number cable group information please see the cable group table (page 21) in this catalog.

### UPL110-XXX\*

RF Coaxial, 75-ohm

1.6/5.6 DIN Threaded Full Crimp Cable Plug



### UBJ110-XXX\*

RF Coaxial Connector, 75-ohm

1.6/5.6 DIN Jack Threaded Connector

Meets requirements of IEC 169-13



### 110 Series Connector Specifications

#### Electrical Data

Characteristic Impedance	75-ohm
Frequency Range	0-3 GHz
VSWR	1.22
Working Voltage	1,500 VRMS at sea level 300VRMS at 65,000 feet
Temperature Range	-40 °C to +85 °C
Insulation Resistance	10,000 MegaOhm min
Contact Resistance	4.0 milli-ohms

#### Mechanical Data

Spring Finger Engagement Force	1.5 lbs min, 5 lbs max
Spring Finger Withdrawal Force	12 oz min
Crimp Strength	50 pounds min avg for 735 type cable 70 pounds min avg for 734 type cable
Durability	500 mating

#### Material

Body	Brass per ASTM-B16
Crimp Sleeve	Brass per ASTM-B16
Socket Contact and Spring Fingers	BeCu per ASTM-B196,197
Pin Contact	Brass per ASTM-B16
Dielectric	PTFE

# INTERNATIONAL TELCO CONNECTORS **1.6/5.6 DIN**



## U-Link: 105-1496

Dual Coaxial DIN Connector "U-link", 75-ohm with two plugs based on the IEC 169-13 specification



## UADF20M110

75-ohm 1.6/5.6 DIN Plug to BNC Jack



## UADM20F110

75-ohm 1.6/5.6 DIN Jack to BNC Plug



## IN-SERIES 75-OHM BNC ADAPTERS

### UBJ24

Bulkhead Cable Jack, Feed-Thru, Non-Insulated



### UBJ228

Socket Contact Coaxial BNC-Type Insulated Feed-Thru Bulkhead Jack



### UAD28

In-Series Female BNC Feed-Thru Adapter



### UBJ28

Bulkhead Jack Feed-Thru, Insulated, 75-ohm



### UBN23

BNC "T" Adapter



### UADRMF220

BNC Adapter, 90°, 75-ohm



# COAXIAL **T**RANSITION CONNECTOR

## Transition Connector (Splice)

This transition connector incorporates Trompeter's industry standard crimp sleeves and center pins, ensuring the same quality cable retention found in our BNC products. Available with pin and crimp sleeve sizes to accommodate all current telephony coax cables.

The splice was designed to facilitate the connection of two different size cables in the same wire-line cable run. It can also be used to connect a cable run that has been cut or broken, or for extending the cable run.

Installation tooling and installation practices are the same as other Trompeter crimp connectors.



### Tool Crimp Cable Transition Connector

(Replace XXX-XXX with Cable Group Numbers from Table 1)

UCCS-XXX-XXX

Table 1

Dash Number	Cable
-025 -026	734D to 735A
-026 -026	735A to 735A
-025 -025	734D to 734D



EXAMPLE OF COMPLETE PART NUMBER:

**UCCS - 025 - 026**

Basic Part Number    025    026  
 Cable Type    Cable    Cable  
 Type    Type    Type

## MINI WECO 440 TYPE PATCH CORDS



### Trompeter Recommended Mainstream Telco Jumpers

Trompeter has standardized our default jumper mini WECO connector to the version with a gold plated barrel and a PTFE-tipped entry bushing. We found this combination gives the highest electrical and mechanical performance and, with the volume generated by standardizing on a single recommendation, we can deliver this without increased cost. We will continue to build other customer-specified versions on the connectors and jumpers, but we recommend first considering this version for these applications.

The recommended jumper connector is the PCMWTL-D-L (L = length in inches) and has a locking tab feature built in as well as a tracer wire. (NOTE: TL in the part name stands for “tracer lead”, not “tab locking”.) It is usually specified as a pair (transmit and receive) and may have a clip that holds the two leads at each end. It is also available as a single cable as part number PCMWTL-S-L (L = length in inches) with no clip. Unless otherwise specified, the cable used is Trompeter’s 735 which is specially built for Trompeter by Judd.

#### J11MW

Miniature Patch Jack  
mini WECO Type, BNC Rear Interface



#### J11MWL

Miniature Patch Jack  
mini WECO type, BNC rear interface



#### ADMW12

Between Series Adapter  
(mini WECO) to 75-ohm BNC



#### PL1MWT-XXX

mini WECO DSX Digital Patch Plug, with Locking Tab

#### PL1MW-XXX

mini WECO DSX Digital Patch Plug, no Locking Tab



#### J11D

Miniature Patch Jack  
Solder pot, mini WECO type



#### J12-XXX

Miniature Patch Jack, Cable Entry,  
Field Serviceable, mini WECO (minimum .64" centers)



Replace XXX with Cable Group Number from the Cable Group Table on page 21.



# CUSTOM CROSS CONNECT PATCHING

## CABLE ASSEMBLIES

Trompetter provides all the flexibility and response of a small cable shop, with the quality system and design control of a major connector manufacturer. For over 35 years, Trompetter has been producing high quality cable assemblies, and currently provides over thousands of different configurations using a broad range of RF connectors and cable types.



PCMWTL-D-[length in inches]  
mini WECO plugs with tracer wire



PCBTL-D-[length in inches]  
Dual Patch Cord: BNC plugs with tracer wire



## REAR CROSS CONNECT JUMPERS WITH TRACER



### Capabilities

Trompeter can provide coax, twinax and triax cable assemblies using any cable attached connector. This includes panel mount, data bus, multi-pin, D-Subs, SMA connectors, and patching products. Special marking (ID sleeves, tags, hot stamping, colored cable jacket, etc...) is available. Trompeter offers 24-48 hour turnaround on many standard products with full capabilities for sustained volume delivery. Deliveries can be adjusted to meet your specific needs. Trompeter's assemblies are 100% electrically tested for continuity, shorts, and Hi-Pot. (Voltage Standing Wave Ratio (VSWR), Isolation Resistance (IR), Insertion/Return Loss test capabilities, SPC data available on request).

### Features

- **Stranded center conductor**  
24 AWG stranded silver coated copper (.024 nom dia)
- **Flexible cable design**  
Gray fire retardant, non-migrating PVC jacketed (.185 nom dia, .028 thick)
- **Tracer lead** — 22 AWG tinned copper with gray PVC jacket (.104 nom dia)
- **Polypropylene foam dielectric** — Fire retardant (.108 nom dia)
- **Braid-Tinned copper over aluminum/polyester**  
90% tinned copper braid over longitudinal aluminum/polyester shield tape, (.001 nom thickness)  
20% min. overlap (100% shield coverage)
- **CM rated** — Meets UL1581 test for vertical tray flame
- Available in **single or dual configurations**

### The Telco Copper Transmission Line

- **DS0** – 64k data rate, one digitally sampled voice channel, 24 of which are “channel bank” multiplexed into a single DS1
- **DS1** – 1.544 Mbps data rate, still twisted pair, also called a T1 line, 28 of which are multiplexed (MUX) into a single DS3
- **DS3** – 44 Mbps data rate, the coax line that is carrying 672 voice channels simultaneously.

# TEST AND MONITOR MODULES



## TMM-2 In-line Test and Monitor Module

The TMM-2 introduces new levels of testing and monitoring cost effectiveness for telecommunications service providers. The TMM-2 is designed for central offices with newer equipment that can be remotely provisioned by sophisticated software, providing the service provider with efficient means of monitoring and maintaining the network.

In these modern central offices, initial turn-up and verification of circuits still require technicians to perform Bit Error Rate Testing (BERT) at the physical level to ensure error-free service to customers. This requires quick test access to the network for BERT, and may also be required by service technicians after initial installation when errors are detected by the network or the customer. The TMM-2 (test and monitor module, 2 ports) enables this location testing to be done for a fraction of the cost of a DSX.



The TMM-2 provides BNC ports on the rear of the module for connections to both sides of the network, providing a normal-thru path for the DS3 circuits. The front panel is equipped with two monitor ports and two network access ports in WECO series patch format. Each monitor port presents a -20dB signal, ensuring error-free monitor capability. Network elements can be accessed by inserting standard WECO plugs into front panel test access jacks, breaking the circuit for BERT requirement. Circuit loop-back for the client is easily accomplished with any 75-ohm “hair-pin” (looping plug) by inserting them into both test access jacks.

## DIGITAL DISTRIBUTION PANELS

### CLEC and IP Service Provider to Network POT Solutions

With multiple service providers co-located in the same space, today's central office requires a new level of accountability. Trompeter offers a full line of point of termination (POT) products designed where the CLEC or IP service provider interconnects with the public network. These products deliver the highest level of connectivity available with a monitoring function for managing signal to noise clarity in the network.

The JSDDF2-24 dual monitored co-location distribution performance modules are constructed with Trompeter's industry standard 75-ohm BNC connectors and provide a cost-efficient interconnect between DS3/4-rated equipment.

- Monitoring jacks allow for sampling or electronic signal screening for digital wave attributes and overall signal clarity. Digital or hand copy records can be maintained to isolate line trouble at the co-location boundary.
- Excellent return loss performance for the thru-ports and nominal signal strength compensation for monitor function.
- Jacks feature locking bayonet mechanism for tactile closure and full pull strength.
- Front and rear designation strips allow installers to work independently.
- Optional cable management bars allow for strain relief on the panel from either or both sides.

### Features & Benefits

**Monitor Jack:** Allows for sampling or electronic screening of the signal for digital wave attributes and overall signal clarity. Depending on the equipment that the monitor is connected to, a digital record or hard copy can be maintained to isolate line trouble at the co-location boundary.

**Electrical Signal Clarity:** Excellent overall return loss performance for the thru-ports.

**BNC Jacks:** Locking bayonet mechanism for tactile closure and cable retention. All ports are conventional telephony coax jacks designed to handle 44 Mbs with signal return loss.

**Designation Strips:** This feature allows the installer to position BNC plugs in the proper port without having to go to the rear of the bay, sometimes quite distant — allowing an installer to work alone.

**Cable Management Bars (Optional):** Allows for strain relief on the panel and BNC jacks, while keeping cables neat and organized.

**Port Markings:** The ports are clearly numbered 1-24 or 1-32 front and back for clear identification.



Co-Location Panel: back

# DIGITAL DISTRIBUTION PANELS

The JSDDF2-24 contains 24 dual monitored distribution performance modules (DDPM-2) and functions as a co-location distribution panel between the CLEC and the Local Exchange Carrier, providing service to access equipment involved in the interconnection to the Internet Service Provider (ISP).

The Trompeter co-location monitor panel is 3RU high and features designation strips on the front and rear for port marking and easy identification. Module locations are numbered front and back. The panel is available with optional cable management bars which can be mounted to the front or rear of the panel via the rack channels.

The signal from the monitor port can be readily attached to a dB millivolt (dBmV) meter to determine power level, or to an oscilloscope to check the noise floor under the primary signal stream.

## Dual Monitored Co-Location Module Application

Monitoring transmission signal in both directions

### Electrical Specifications

Nominal Impedance (0-500 MHz)	75-ohm
Performance Monitor Level (0-500 MHz)	-20 dB $\pm$ 0.5 dB
Thru-Port Insertion Loss (0-500 MHz)	Better than -0.34 dB
Thru-Port Return Loss (0-500 MHz)	Better than -22 dB
Isolation (0-500 MHz)	60 dB min

### Part Numbers

JSDDF2-24  
19" Panel, 24 Modules

JSDDF2-24CM  
19" Panel, 24 Modules,  
Cable Management Bar

JSDDF2-24L  
23" Panel, 24 Modules

### Part Numbers

JSDDF2-24LCM  
23" Panel, 24 Modules,  
Cable Management Bar

JSDDF2-32  
23" Panel, 32 Modules

JSDDF2-32CM  
23" Panel, 32 Modules,  
Cable Management Bar

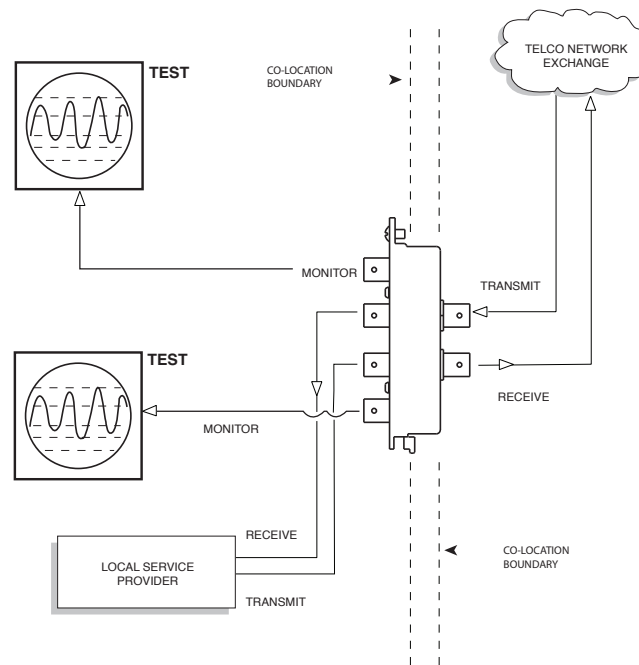

Monitors can be positioned on either side of the co-location boundary.



## DIGITAL DISTRIBUTION PANELS

### Panel Loaded with 24 Modules



### Module Part Number DDPM-2



### Panel without Modules Loaded



### Part Numbers

JSDDF2-24  
19" Panel, 24 Modules

JSDDF2-24CM  
19" Panel, 24 Modules, Cable  
Management Bar

JSDDF2-24L  
23" Panel, 24 Modules

JSDDF2-24LCM  
23" Panel, 24 Modules, Cable  
Management Bar

JSDDF2-32  
23" Panel, 32 Modules

JSDDF2-32CM  
23" Panel, 32 Modules, Cable  
Management Bar

155-1012-1  
19" Panel to Accommodate 24 Modules

155-1012-2  
23" Panel to Accommodate 24 Modules

155-1012-3  
23" Panel to Accommodate 32 Modules

### Optional Cable Management Bar

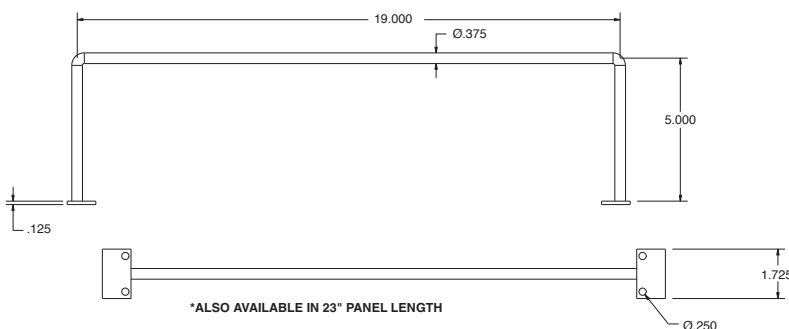

# DIGITAL DISTRIBUTION PANELS



## Electrical Specifications

Nominal Impedance (0-500 MHz)	75-ohm
Performance Monitor Level (0-500 MHz)	-20 dB $\pm$ 0.5 dB
Thru Port Insertion Loss (0-500 MHz)	Better than -0.34 dB
Thru Port Return Loss (0-500 MHz)	Better than -22 dB
Isolation (0-500 MHz)	60 dB min

## 19" and 23" Standard Pass-Thru Panels

### Standard Aluminum Panels

- Fully loaded with UBJ24I (Insulated Bulkhead Jacks)
- Cable management bars are also available



### Part Numbers

JSCL-48  
19 Inch Panel, 48 BNC Bulkhead Jacks

JSCL-48CM  
19 Inch Panel, 48 BNC Bulkhead Jacks, Cable Management Bar

JSCL-48L  
23 Inch Panel, 48 BNC Bulkhead Jacks

JSCL-48LCM  
23 Inch Panel, 48 BNC Bulkhead Jacks, Cable Management Bar

## PARALLEL NETWORK

The parallel network serves as an equal level cross-connect point for coax signals conforming to the following signal formats.

- 2.048 Mbits
- 8.448 Mbits
- 34.048 Mbits
- 139.264 Mbits CEPT 1, 2, 3 and 4
- 155.520 Mbits STM 1

This 75-ohm network permits access to all equipment terminated at the DDF frame. The network mounts to various configurations (both horizontal and vertical), serves as an easy access to circuit rearrangements and provides for cross connects on the front or the rear.



### 75-ohm Parallel Network



- UBJM24 BNC Panel Mount with 20dB Monitor Port
- UBJ24 BNC Panel Mount, Feed-Thru

### 75-ohm Parallel Network



- 105-1513 Dual Monitor Interconnect Module with 20dB Monitor Ports

# APPENDIX GLOSSARY

## Acronyms

ANSI	American Nation Standards Institute	ISO	International Standards Organization
BNC	Bayonet-Neill-Concelman	N-AMPS	Narrowband Advanced Mobile Phone System
CDMA	Code Division Multiple Access	NEBS	National Equipment Building Systems
DACS	Digital Access Cross-Connect System	PCS	Cellular/Personal Communications Services
DSP	Digital Signal Processing	PIN	Personal Identification Number
DSX	Digital Signal Cross-Connect	POP	Point of Presence
EDI	Electronic Data Interchange	POT	Point of Termination
EMC	Electromagnetic Compatibility	POTS	Plain Old Telephone Service
EMI	Electromagnetic Interference	RBOC	Regional Bell Operating Company
FCC	Federal Communications Commission	RF	Radio Frequency
FDMA	Frequency Division Multiple Access	TCP/IP	Transmission Control Protocol/Internet Protocol
GPS	Global Positioning System	TDMA	Time Division Multiple Access
GSM	Global System For Mobile Communications	TIA	Telecommunications Industry Association
GUI	Graphical User Interface	VSWR	Voltage Standing Wave Ratio
ISDN	Integrated Services Digital Network		

## Telco DS3 Glossary

- 440-TYPE PLUG/JACK** Standard 0.3 inch diameter plug/jack, also known as mini WECO coaxial jack
- AMPLIFIER** A device used to increase the operating level of an input signal. Used in a cable system's distribution plant to compensate for the effects of attenuation caused by coaxial cable and passive device losses.
- ATTENUATION** The difference between transmitted and received power due to loss from lines, electronic components, or other transmission devices; usually expressed in decibels (dB).
- BNC** Bayonet-locking connector for slim coax cables. BNC is an acronym for Bayonet-Neill-Concelman, the inventors.
- BODY** Main or largest portion of a connector to which other components are attached.
- BRAID** Weave of metal fibers used as a shield covering for an insulated conductor or a group of insulated conductors.
- BULKHEAD** Term used to define a mounting style of connectors. Bulkhead connectors are designed to be inserted into a panel cutout from the front or the rear of the panel, and typically secured with a jam nut.
- COAX CABLE** Cable composed of an insulated central conducting wire, wrapped in another cylindrical conducting wire or braid. Coax cable has great capacity to carry high speed data typically used in Cable TV, connecting computers and central office switching.
- CO LINES** Lines connecting your office to the telephone company's Central Office which in turn connects you to the nationwide telephone system, which is a WAN (Wide Area Network)
- COMMUNICATION PANEL** Piece of auxiliary DSX equipment that provides various voice communication circuits that are used in DS maintenance operations.
- CONTACT** Electrically conductive component designed for use in a multi-circuit connector.
- CONTACT ENGAGING and SEPARATING FORCE** Force required to either engage or separate contacts.
- CONTACT RESISTANCE** Measurement of electrical resistance of mated contacts when assembled in a connector under typical service use.
- CROSS TALK** Magnetic or electromagnetic coupling which causes unwanted signal transfer from one circuit to another circuit.
- DECIBEL (dB)** A unit of measurement which expresses the ratio of two power levels on a logarithmic scale. It is used in cable systems to specify losses, gains, and other ratios of power. The decibel is one-tenth of a Bell.
- DIGITAL ACCESS CROSS** Electronic cross-connect system that has the ability to rearrange the digital components
- CONNECT SYSTEM (DACS)** of a particular transmission T-1 rate.

## APPENDIX GLOSSARY

**DS3** 28 T-1 lines multiplexed together. Usually coaxial.

**DIGITAL SIGNAL CROSS-CONNECT (DSX)**

Centralized termination, interconnection, and test point for digital equipment at a particular digital signal bit rate.

**GROUND** Connection, intentional or accidental, between an electrical circuit and the earth or some conducting body (i.e. chassis) serving in place of earth.

**HIT** Temporary interruption of service lasting 90 msec (milliseconds) maximum; that causes reframing of digital equipment.

**IMPEDANCE** Resistance to the flow of AC current. In the telco CO and CATV system, the characteristic impedance is 75-ohms. If all cable and devices are equal to the characteristic impedance, maximum signal will be transferred with little or no reflection.

**IMPEDANCE MISMATCH** A situation that results when two components are connected, each having a different characteristic impedance. This generally results in adverse attenuation and return loss.

**INSERTION LOSS** That property between the input and output of a device causing a predictable signal loss.

**INTERMODULATION** Beats and harmonics creating interference due to the mixing of more than one carrier in an amplifying device. Usually to non-linear.

**JUMPER** Manually placed wire connection between two terminations, usually on some form of a distributing frame (DF). A jumper is also called a cross-connect.

**LOOP BACK** Connecting the two directions of digital transmission, thereby looping the signal back to its origin. It is used to test the continuity of the line.

**MATCHED IMPEDANCE** Coupling of two components or systems in such a way that the impedance of one system equals the impedance of the other system.

**MONITOR JACK** Allows access to a DSX output signal without disturbing the signal. The MON jack is typically used for testing and “hitless” patching of signals

**MONITOR LEVEL SIGNAL** Signal that is typically 20dB below the standard signal level.

**NETWORK ANALYZER** Known in the industry as a bench sweep, this test equipment is used to test return loss, impedance match, and frequency response of active and passive devices in the system.

**OHM’S LAW** The relationship between voltage, current, and resistance in an electronic circuit. The third quantity can be found if two are known.

**PASSIVE DEVICE** A device used in a cable system not requiring electrical power to operate. It normally represents loss to signals passing through it. Examples of passive devices are splitters, directional couplers, pads, and equalizers.

**PRIVATE BRANCH EXCHANGE (PBX)** A business phone system that is private but connected to the public telephone network. Performs a variety of in-house routing and switching. User usually dials 9 to get outside the system to local lines.

**PULSE CODE MODULATION (PCM)** The form of modulation in which the information signals are sampled at regular intervals and a series of pulses in coded form are transmitted representing the amplitude of the information signal at that time. The most common modulation technique involved in telephone work.

**PULSE MODULATION** The modulation of a series of pulses that represent information-bearing signals. Typical methods involve modifying the amplitude (PAM), width or duration (PWM), or position (PPM).

**REGENERATION** The process of receiving distorted signal pulses and, from them, recreating new pulses at the correct repetition rate, pulse amplitude, and pulse width.

**RETURN LOSS** The value (in decibels) of the ratio of the power or voltage loss between the forward (transmitted) wave and the reflected wave, as a result of impedance mismatch.

**RETURN PATH** The band of frequencies used to return signals to the cable headend either as control data or for redistribution on the forward path.

**RF** Abbreviation for “radio frequency”. Typically between 300KHz through 3GHz.

**RG/U** (R-radio frequency, G-government approval number, U-universal specification). Symbol for Government specified coaxial cable.

**SIGNAL-TO-NOISE RATIO (SNR)** Ratio of the signal power to the noise power in a specified bandwidth, usually expressed in dB.

**SPECTRUM ANALYZER** A test instrument used to evaluate amplitude vs. frequency over the pass band of interest.

**SPECTRUM RETURN LOSS (SRL)** Periodic discontinuities found in cable causing both impedance changes and attenuation in cables. SRL is caused by either manufacturing impurities at the factory or mishandling before, during, or after delivery. In connectors, return loss is caused by poor design, inferior materials and/or plating, or improper installation.



# APPENDIX GLOSSARY

**T-1 LINE** 24 voice channels digitized at 64K, combined into a single 544 Mbps digital system (8,000 bps signaling), and carried over two pairs of regular copper telephone wires. Used primarily by telephone companies for dedicated local access to long distance facilities, long-haul private lines, and for regular local service. Today, most 1.544 Mbps digital streams are called T-1, regardless of its makeup or what the transmission medium is.

**TCP/IP** Transmission Control Protocol/Internet Protocol. The two open protocol standards used among computers connected to the Internet. Allow different computer systems and platforms to share data seamlessly.

**TIME DOMAIN REFLECTOMETER (TDR)** A test instrument that sends a signal down a length of cable and measures the reflected signal, allowing the distance to a fault to be measured based on the time differential between the incident and reflected signals.

**TIP** The side of a two-wire telephone circuit that is connected to the positive side of a battery at the telco central office. Color-coded green. Similar to the ground side of a residential lighting circuit.

**TRACING LAMP** Lamp or Light emitting Diode (LED) provided as part of a standard DSX patch and cross-connect circuit that aids in locating the two ends of a cross-connect. Inserting a plug into the MON jack at one end of a cross-connect caused the tracing lamps at both ends of the cross-connect to illuminate.

**TRUNK** A telephone circuit or path between two switches, at least one of which is usually a telephone company central office or switching center. Regular local central office circuits are called PBX trunks, because there is a switch at both ends of the circuit.

**VELOCITY OF PROPAGATION** The velocity of signal transmission in a cable relative to the speed of light in free space.

**VERTICAL THROUGH** Jumper pathway that is provided between adjacent DSX bays to allow jumpers to run vertically on the frame one panel location to another, or between a panel and the upper or lower express through.

**VOICE FREQUENCY** Any of the frequencies in the 300-to-3,400-Hz band used to transmitted voice with reasonable fidelity.

**VOICE GRADE** An access line suitable for voice, low-speed data, facsimile, or telegraph service. Generally has a frequency range of about 300 to 3,000 Hz.

**VOLTAGE DROP** The voltage developed across a component or conductor by the flow of a current through the resistance or impedance of that component or conductor.

**VSWR** Abbreviation for Voltage Standing Wave Ratio, a measure of return loss of a transmission circuit.

**WATERFALL CABLING** Method of routing cables between overhead cable racks and the DSX panels that employs the full width of the rear of the DSX frame.



## APPENDIX BNC PLUG ASSEMBLY INSTRUCTION

### "Full Crimp" True 75-ohm Connectors to Flexible Coaxial Cable



**CABLE STRIPPING DIMENSIONS**  
(SHOWN AS ACTUAL SIZE: USE AS STRIPPING TEMPLATE)

#### STEP 1

1. CUT CABLE TO LENGTH



#### STEP 2

1. PLACE CRIMP SLEEVE ONTO CABLE WITH STEP LOCATED AS SHOWN.
2. STRIP CABLE AS SHOWN AND FLARE BRAID.
3. CRIMP CONTACT IN POSITION SHOWN (SEE CHART)



#### STEP 3

1. PUSH CABLE ASSEMBLY INTO BODY ASSEMBLY UNTIL CONTACT SNAPS INTO PLACE.
2. SLIDE CRIMP SLEEVE FORWARD OVER BRAID UP AGAINST BODY ASSEMBLY AND CRIMP IN PLACE (SEE CHART).

Cable Group Dash No	Crimp Sleeve		Center Contact
	Hex Size	Die No/ Closure	
-001*	.178	-19/A	
-002*	.197	-5/B	
-003*	.178	-1/B	
-004*	.178	-19/A	
-005*	.197	-5/B	
-006*	.197	-5/B	
-007*	.178	-19/A	
-008	.178	-19/A	
-009	.178	-19/A	
-010	.178	-19/A	
-011	.213	-1/A	
-012	.213	-1/A	
-013	.255	-19/B	Use Trompeter Pin Contact Crimp Tool No. 010-0098
-013A	.255	-19/B	
-014	.255	-19/B	
-015	.290	-3/B	
-016	.324	-2/A	
-017	.344	-3/A	
-018	.255	-19/B	
-020	.290	-3/B	
-021	.213	-1/A	
-023	.255	-2/B	
-024	.290	-3/B	
-025	.255	-19/B	
-026	.178	-19/A	
-027*	.178	-19/A	

Tool: Trompeter Crimp Tool CT4L with  
Die Set No. CD3-(see above)

\* FILLER SLEEVE  
(USED ONLY ON CONNECTORS  
-001 THRU -007 & -027)



Note: Revision level changes periodically. Please check with factory for latest revision on these instructions.

# APPENDIX PART NUMBER INDEX

Part Number	Page	Part Number	Page	Part Number	Page
010-0055	16-17	CD5A-1	14	RTC-1L	15-17
010-0080	16-17	CT4L	14	RTR-1L	15-17
010-0088	16-17	DDPM-2	34	RTR-4L	15-17
010-0097	16-17	J11D	28	RTR-4L	15-17
010-0098	16-17	J11MW	28	ST1	13, 16
010-0108	15, 17	J11MWL	28	STC-F	13, 16
010-0133	15, 17	J12-XXX	28	TMM-2	31
010-0158	15, 17	JSCL-48CM	35	UAD28	26
010-0179	22	JSCL-48L	35	UADF20M110	25
010-0208	15, 17	JSCL-48LCM	35	UADM20F110	25
105-1496	25	SDDDF2-24	33-34	UADRMF220	26
105-1513	36	JSDDF2-24L	33-34	UBJ110-XXX	24
105-1885	15	JSDDF2-24LCM	33-34	UBJ24	26, 36
155-1012-1	34	JSDDF2-32	33-34	UBJ228	26
155-1012-2	34	JSDDF2-32CM	33-34	UBJ28	26
155-1012-3	34	JSTDSX-TIE	31	UBJM24	39
700-0024	13, 16-17	PCBTL-D-L	29	UBN23	26
ACC	13	PCBTL-S-L	29	UCCS-XXX-XX	27
ACS	13	PCMWTL-D-L	29	UPL110-XX	24
ADMW1-2	28	PCMWTL-S-L	29	UPL143-XXX	23
BCCS/C24T3D	13	PL1MW-XXX	28	UPLR143-XXX	23
BCCS/C24T3I	13	PL1MWLT-XXX	28	UPL220-XXX	4-7
BCS-DO	13	RBP	13	UPL250-XXX	8-10
C24T3(A-U)	13	RT1L	15-17	UPLFF220-XXX	6-7
CD3-1/23	13	RT1S	15-17	UPLR220-XXX	6-7
CD3-19	14	RT1SS	15-17	UPLR250-XXX	8-10
CTB-1	14	RT1XL	15-17		

For Trompeter's Sales Representatives and Distributors World Wide, Visit Our Website!

Technical Support:  
[techsupport@trompeter.com](mailto:techsupport@trompeter.com)

Customer Service & Sales:  
[sales@trompeter.com](mailto:sales@trompeter.com)

Pricing & Delivery:  
[sales@trompeter.com](mailto:sales@trompeter.com)

Trompeter Electronics, Inc.  
5550 E. McDowell Road  
Mesa, Arizona USA 85215

Toll Free (Domestic): 800.982.2629

Direct: 480.985.9000

Fax: 480.985.3464

[www.trompeter.com](http://www.trompeter.com)

## Emerson Network Power Connectivity Solutions

Trompeter  
5550 E. McDowell Road  
Mesa, AZ 85215  
USA

Tel: 480.985.9000

Fax: 480.985.0334

[www.trompeter.com](http://www.trompeter.com)

## About Emerson Network Power Connectivity Solutions

Emerson Network Power Connectivity Solutions, an Emerson business, serves the needs of wireless communications, telephony and data networks, CATV, security systems, health care and industrial facilities with a full spectrum of broadband copper and fiber optic connectivity products. For more information, visit [www.EmersonNetworkPower.com/Connectivity](http://www.EmersonNetworkPower.com/Connectivity).

## About Emerson

Emerson (NYSE: EMR), based in St. Louis, is a global leader in bringing technology and engineering together to provide innovative solutions to customers through its network power, process management, industrial automation, climate technologies, and appliance and tools businesses. For more information, visit [www.gotoemerson.com](http://www.gotoemerson.com).

## Emerson Network Power.

The global leader in enabling business-critical continuity.

- AC Power Systems
- Embedded Power
- Outside Plant
- Connectivity
- Inbound Power
- Precision Cooling
- DC Power Systems
- Integrated Cabinet Solutions
- Site Monitoring and Services

[www.EmersonNetworkPower.com](http://www.EmersonNetworkPower.com)

Компания «Океан Электроники» предлагает заключение долгосрочных отношений при поставках импортных электронных компонентов на взаимовыгодных условиях!

Наши преимущества:

- Поставка оригинальных импортных электронных компонентов напрямую с производств Америки, Европы и Азии, а так же с крупнейших складов мира;
- Широкая линейка поставок активных и пассивных импортных электронных компонентов (более 30 млн. наименований);
- Поставка сложных, дефицитных, либо снятых с производства позиций;
- Оперативные сроки поставки под заказ (от 5 рабочих дней);
- Экспресс доставка в любую точку России;
- Помощь Конструкторского Отдела и консультации квалифицированных инженеров;
- Техническая поддержка проекта, помощь в подборе аналогов, поставка прототипов;
- Поставка электронных компонентов под контролем ВП;
- Система менеджмента качества сертифицирована по Международному стандарту ISO 9001;
- При необходимости вся продукция военного и аэрокосмического назначения проходит испытания и сертификацию в лаборатории (по согласованию с заказчиком);
- Поставка специализированных компонентов военного и аэрокосмического уровня качества (Xilinx, Altera, Analog Devices, Intersil, Interpoint, Microsemi, Actel, Aeroflex, Peregrine, VPT, Syfer, Eurofarad, Texas Instruments, MS Kennedy, Miteq, Cobham, E2V, MA-COM, Hittite, Mini-Circuits, General Dynamics и др.);

Компания «Океан Электроники» является официальным дистрибьютором и эксклюзивным представителем в России одного из крупнейших производителей разъемов военного и аэрокосмического назначения «JONHON», а так же официальным дистрибьютором и эксклюзивным представителем в России производителя высокотехнологичных и надежных решений для передачи СВЧ сигналов «FORSTAR».



## JONHON

«JONHON» (основан в 1970 г.)

Разъемы специального, военного и аэрокосмического назначения:

(Применяются в военной, авиационной, аэрокосмической, морской, железнодорожной, горно- и нефтедобывающей отраслях промышленности)

«FORSTAR» (основан в 1998 г.)

ВЧ соединители, коаксиальные кабели, кабельные сборки и микроволновые компоненты:

(Применяются в телекоммуникациях гражданского и специального назначения, в средствах связи, РЛС, а так же военной, авиационной и аэрокосмической отраслях промышленности).



Телефон: 8 (812) 309-75-97 (многоканальный)

Факс: 8 (812) 320-03-32

Электронная почта: [ocean@oceanchips.ru](mailto:ocean@oceanchips.ru)

Web: <http://oceanchips.ru/>

Адрес: 198099, г. Санкт-Петербург, ул. Калинина, д. 2, корп. 4, лит. А