

## SK625xD Series

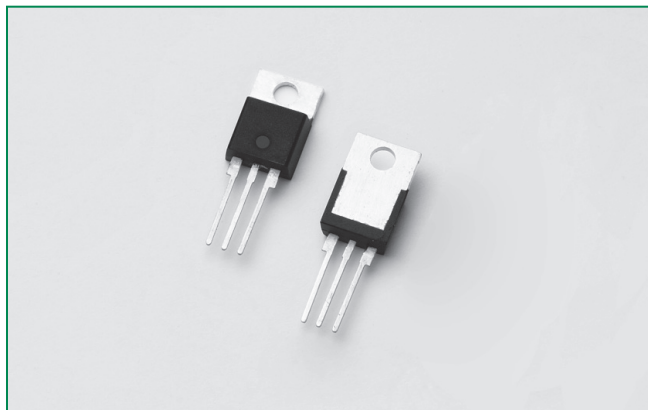

### Description

Excellent unidirectional switches for phase control applications such as heating and motor speed controls. Standard phase control SCRs are triggered with few milliamperes of current at less than 1.5V potential.

### Features & Benefits

- RoHS compliant
- Voltage capability up to 1600 V
- Surge capability up to 250 A
- Electrically isolated package "LD-Package" and UL recognized for 2500V<sub>RMS</sub>

### Agency Approval

Agency	Agency File Number
	E71639

### Main Features

Symbol	Value	Unit
$I_{T(RMS)}$	25	A
$V_{DRM}/V_{RRM}$	1600	V
$I_{GT}$	35	mA

### Applications

Typical applications are AC solid-state switches, industrial power tools, line rectification 50/60Hz.

Internally constructed isolated packages are offered for ease of heat sinking with highest isolation voltage.

### Schematic Symbol

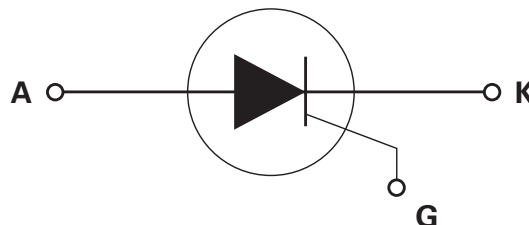

**Absolute Maximum Ratings — 25A SCR**

Symbol	Parameter	Test Conditions		Value	Unit
$V_{DRM}/V_{RRM}$	Repetitive Peak off-state/Reverse Voltage			1600	V
$V_{DSM}/V_{RSM}$	Non-repetitive peak off-state/Reverse voltage			1700	V
$I_{T(RMS)}$	RMS on-state current	SK625LD	$T_C = 60^\circ\text{C}$	25	A
		SK625RD	$T_C = 90^\circ\text{C}$		
$I_{T(AV)}$	Average on-state current	SK625LD	$T_C = 60^\circ\text{C}$	16	A
		SK625RD	$T_C = 90^\circ\text{C}$		
$I_{TSM}$	Peak non-repetitive surge current	single half cycle; f = 50Hz; $T_J$ (initial) = 25°C		250	A
		single half cycle; f = 60Hz; $T_J$ (initial) = 25°C		300	
$I^2t$	$I^2t$ Value for fusing	$t_p = 8.3$ ms		375	A <sup>2</sup> s
di/dt	Critical rate of rise of on-state current			100	A/ $\mu$ s
$I_{GM}$	Peak gate current	$T_J = 125^\circ\text{C}$		1.5	A
$P_{G(AV)}$	Average gate power dissipation	$T_J = 125^\circ\text{C}$		1	W
$T_{stg}$	Storage temperature range			-40 to 150	°C
$T_J$	Operating junction temperature range			-40 to 125	°C

Notes :  
 x = package

**Electrical Characteristics ( $T_J = 25^\circ\text{C}$ , unless otherwise specified)**

Symbol	Test Conditions		Value	Unit
$I_{GT}$	$V_D = 12\text{V}; R_L = 30\Omega$	MAX.	35	mA
$V_{GT}$		MAX.	1.5	V
dv/dt	$V_D = 2/3 V_{DRM}$ ; gate open; $T_J = 125^\circ\text{C}$	MIN.	2000	V/ $\mu$ s
$V_{GD}$	$V_D = V_{DRM}$ ; $R_L = 3.3$ k $\Omega$ ; $T_J = 125^\circ\text{C}$	MIN.	0.2	V
$I_H$	$I_T = 500\text{mA}$ (initial)	MAX.	120	mA
$t_q$	$I_T = 0.5\text{A}$ ; $t_p = 50\mu\text{s}$ ; dv/dt=5V/ $\mu$ s; di/dt=-30A/ $\mu$ s	TYP.	25	$\mu$ s
$t_{gt}$	$I_G = 2 \times I_{GT}$ ; PW = 15 $\mu$ s; $I_T = 50\text{A}$	TYP.	5	$\mu$ s

Notes :  
 x = package

**Static Characteristics**

Symbol	Test Conditions		Value	Unit	
$V_{TM}$	$I_T = 50\text{A}$ ; $t_p = 380\mu\text{s}$	MAX.	1.8	V	
$I_{DRM}/I_{RRM}$	$V_{DRM}/V_{RRM}$	$T_J = 25^\circ\text{C}$	MAX.	10	$\mu$ A
		$T_J = 125^\circ\text{C}$		4	mA

**Thermal Resistances**

Symbol	Parameter	Value	Unit
$R_{\theta(J-C)}$	Junction to case (AC)	SK625RD	1.0
		SK625LD	1.9

**Figure 1: Normalized DC Gate Trigger Current vs. Junction Temperature**

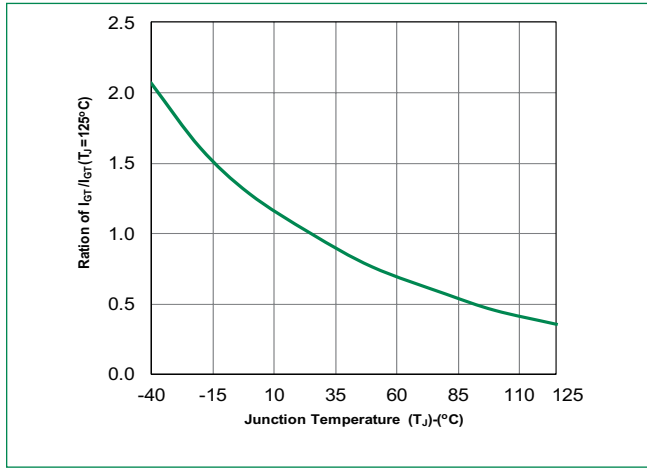

**Figure 2: Normalized DC Gate Trigger Voltage vs. Junction Temperature**

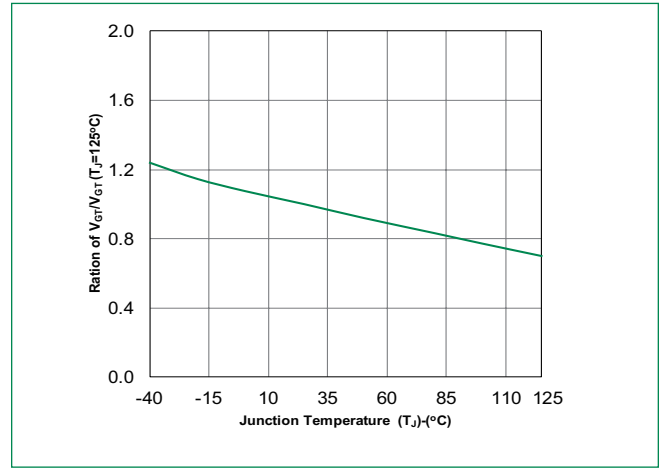

**Figure 3: Normalized DC Holding Current vs. Junction Temperature**

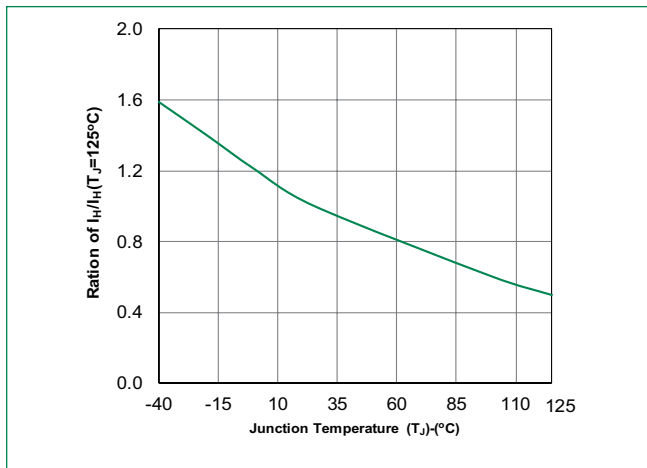

**Figure 4: On-State Current vs. On-State Voltage (Typical)**

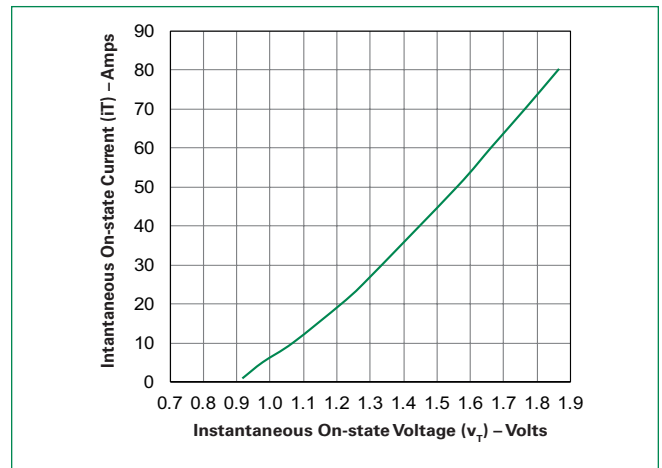

**Figure 5: Power Dissipation (Typical) vs. RMS On-State Current**

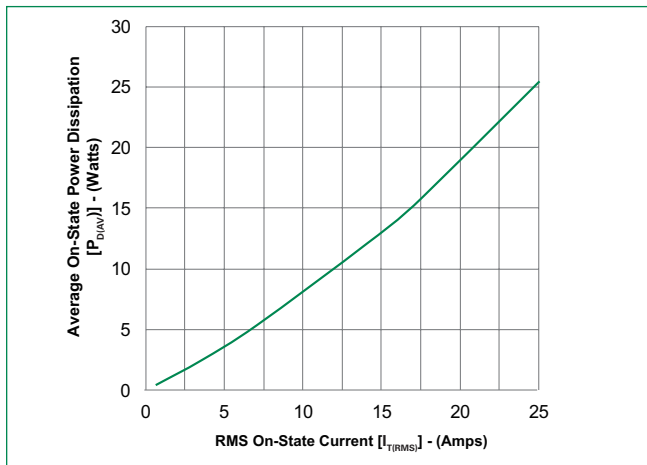

**Figure 6: Maximum Allowable Case Temperature vs. RMS On-State Current**

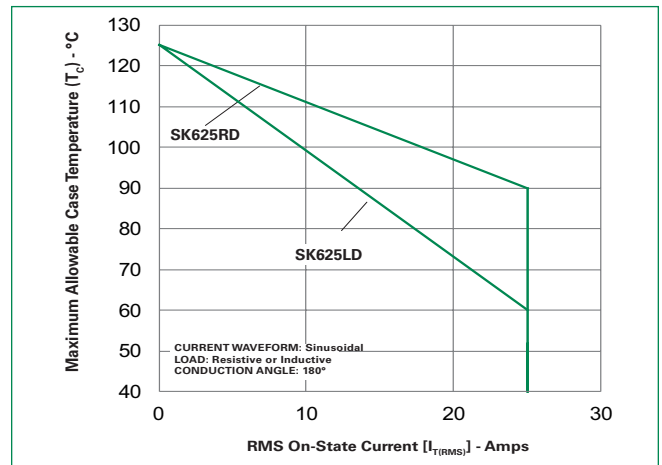

**Figure 7: Maximum Allowable Case Temperature vs. Average On-State Current**

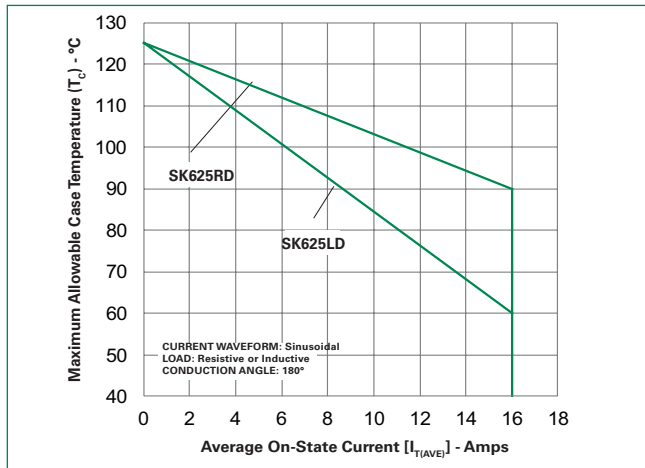

**Figure 8: Surge Peak On-State Current vs. Number of Cycles**

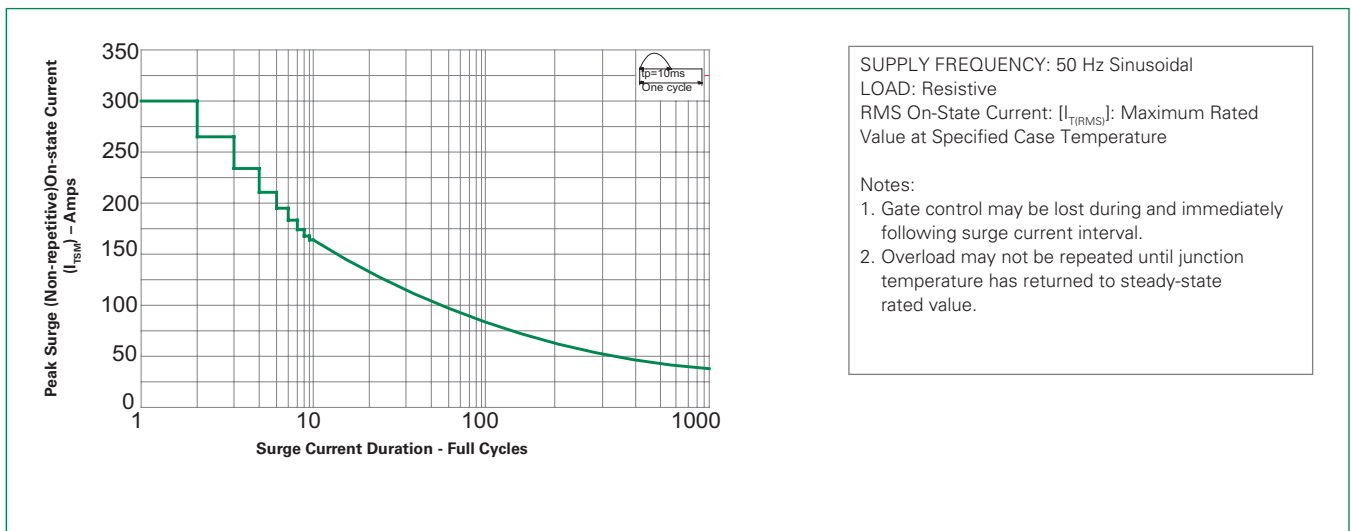

**Environmental Specifications**

Test	Specifications and Conditions
<b>AC Blocking</b>	JESD22-A108C, 80% V <sub>DRM</sub> @125°C for 168 hours
<b>Temperature Cycling</b>	MIL-STD-750, M-1051, 100 cycles; -40°C to +150°C; 15-min dwell-time
<b>Temperature/Humidity</b>	EIA / JEDEC, JESD22-A101 168 hours; 100V - DC: 85°C; 85% rel humidity
<b>Resistance to Solder Heat</b>	JESD22-B106C
<b>Solderability</b>	J-STD-022, category 3, test A

**Design Considerations**

Careful selection of the correct device for the application's operating parameters and environment will go a long way toward extending the operating life of the Thyristor. Good design practice should limit the maximum continuous current through the main terminals to 75% of the device rating. Other ways to ensure long life for a power discrete semiconductor are proper heat sinking and selection of voltage ratings for worst case conditions. Overheating, overvoltage (including dv/dt), and surge currents are the main killers of semiconductors. Correct mounting, soldering, and forming of the leads also help protect against component damage.

**Dimensions — TO-220AB (RD-Package) — Non-Isolated Mounting Tab Common with Center Lead**

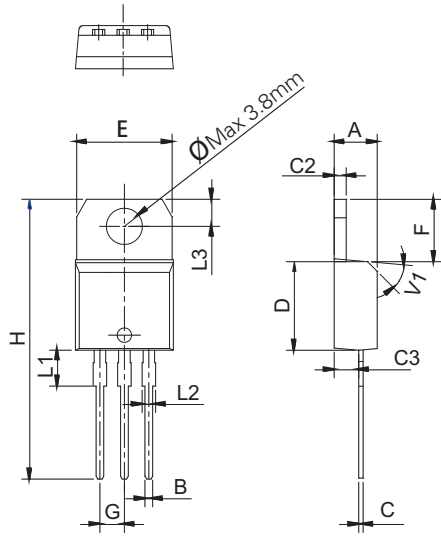

Note: Maximum torque to be applied to mounting tab is 3 in-lbs (0.3Nm).

Dimension	Millimeters			Inches		
	Min.	Typ.	Max.	Min.	Typ.	Max.
A	4.40		4.60	0.173		0.181
B	0.61		0.88	0.024		0.035
C	0.46		0.70	0.018		0.028
C2	1.21		1.32	0.048		0.052
C3	2.40		2.72	0.094		0.107
D	8.60		9.70	0.339		0.382
E	9.60		10.4	0.378		0.409
F	6.20		6.60	0.244		0.260
G		2.54			0.1	
H	28.0		29.8	1.102		1.173
L1		3.75			0.148	
L2	1.14		1.70	0.045		0.067
L3	2.65		2.95	0.104		0.116
V1		45°			45°	

**Dimensions — TO-220AB (LD-Package) — Isolated Mounting Tab**

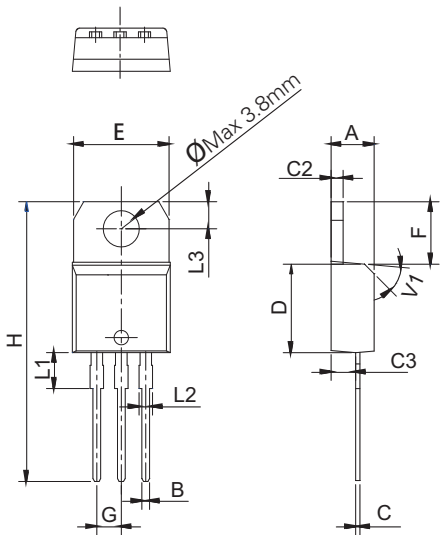

Note: Maximum torque to be applied to mounting tab is 7 in-lbs. (0.8 Nm).

Dimension	Millimeters			Inches		
	Min.	Typ.	Max.	Min.	Typ.	Max.
A	4.40		4.60	0.173		0.181
B	0.61		0.88	0.024		0.035
C	0.46		0.70	0.018		0.028
C2	1.21		1.32	0.048		0.052
C3	2.40		2.72	0.094		0.107
D	8.60		9.70	0.339		0.382
E	9.80		10.4	0.386		0.409
F	6.55		6.95	0.258		0.274
G		2.54			0.1	
H	28.0		29.8	1.102		1.173
L1		3.75			0.148	
L2	1.14		1.70	0.045		0.067
L3	2.65		2.95	0.104		0.116
V1		45°			45°	

**Product Selector**

Part Number	Gate Sensitivity	Type	Package
SK625LD	35mA	Standard SCR	TO-220L
SK625RD	35mA	Standard SCR	TO-220R

**Packing Options**

Part Number	Marking	Weight	Packing Mode	Base Quantity
SK625LDTP	SK625LD	2.2g	Tube	1000
SK625RDTP	SK625RD	2.0g	Tube	1000

**Part Numbering System**

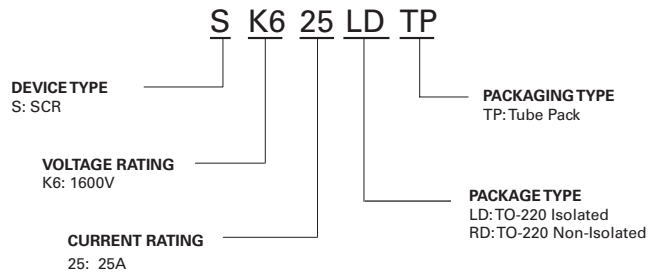

**Part Marking System**

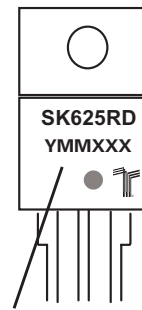

Date Code Marking  
 Y: Year Code  
 MM: Month Code  
 XXX: Lot Trace Code

Компания «Океан Электроники» предлагает заключение долгосрочных отношений при поставках импортных электронных компонентов на взаимовыгодных условиях!

Наши преимущества:

- Поставка оригинальных импортных электронных компонентов напрямую с производств Америки, Европы и Азии, а так же с крупнейших складов мира;
- Широкая линейка поставок активных и пассивных импортных электронных компонентов (более 30 млн. наименований);
- Поставка сложных, дефицитных, либо снятых с производства позиций;
- Оперативные сроки поставки под заказ (от 5 рабочих дней);
- Экспресс доставка в любую точку России;
- Помощь Конструкторского Отдела и консультации квалифицированных инженеров;
- Техническая поддержка проекта, помощь в подборе аналогов, поставка прототипов;
- Поставка электронных компонентов под контролем ВП;
- Система менеджмента качества сертифицирована по Международному стандарту ISO 9001;
- При необходимости вся продукция военного и аэрокосмического назначения проходит испытания и сертификацию в лаборатории (по согласованию с заказчиком);
- Поставка специализированных компонентов военного и аэрокосмического уровня качества (Xilinx, Altera, Analog Devices, Intersil, Interpoint, Microsemi, Actel, Aeroflex, Peregrine, VPT, Syfer, Eurofarad, Texas Instruments, MS Kennedy, Miteq, Cobham, E2V, MA-COM, Hittite, Mini-Circuits, General Dynamics и др.);

Компания «Океан Электроники» является официальным дистрибьютором и эксклюзивным представителем в России одного из крупнейших производителей разъемов военного и аэрокосмического назначения «JONHON», а так же официальным дистрибьютором и эксклюзивным представителем в России производителя высокотехнологичных и надежных решений для передачи СВЧ сигналов «FORSTAR».



## JONHON

«JONHON» (основан в 1970 г.)

Разъемы специального, военного и аэрокосмического назначения:

(Применяются в военной, авиационной, аэрокосмической, морской, железнодорожной, горно- и нефтедобывающей отраслях промышленности)

«FORSTAR» (основан в 1998 г.)

ВЧ соединители, коаксиальные кабели, кабельные сборки и микроволновые компоненты:

(Применяются в телекоммуникациях гражданского и специального назначения, в средствах связи, РЛС, а так же военной, авиационной и аэрокосмической отраслях промышленности).



Телефон: 8 (812) 309-75-97 (многоканальный)

Факс: 8 (812) 320-03-32

Электронная почта: [ocean@oceanchips.ru](mailto:ocean@oceanchips.ru)

Web: <http://oceanchips.ru/>

Адрес: 198099, г. Санкт-Петербург, ул. Калинина, д. 2, корп. 4, лит. А