

MIC4812



High Current 6 Channel Linear WLED Driver with DAM™ and Ultra Fast PWM™ Control

General Description

The MIC4812 is a high efficiency linear White LED (WLED) driver designed to drive up to six high current WLEDs for signage lighting. The MIC4812 provides the highest possible efficiency as this architecture has no switching losses present in traditional charge pumps or inductive boost circuits. The MIC4812 provides six linear drivers which maintain constant current for up to six WLEDs. It features a typical dropout of 190mV at 100mA.

The MIC4812 features Dynamic Average Matching™ (DAM™) which is specifically designed to provide optimum matching across all WLEDs. The high accuracy ($\pm 1\%$ typical) current regulated WLED channels ensure uniform display illumination under all conditions. The brightness is controlled through an Ultra Fast PWM™ interface operating down to less than 1% duty cycle.

The MIC4812 is available in an 10-pin MSOP ePad package with a junction temperature range of -40°C to $+125^{\circ}\text{C}$.

Datasheets and support documentation can be found on Micrel's web site at: www.micrel.com.

Features

- High Efficiency (no Voltage Boost losses)
- Ultra Fast PWM™ control (200Hz to 500kHz)
- Input voltage range: 3.0V to 5.5V
- LED current range up to 100mA per channel
- Programmable LED current with external resistor
- Dropout of 190mV at 100mA
- Matching better than $\pm 1\%$ (typical)
- Current Accuracy better than $\pm 1\%$ (typical)
- Maintains proper regulation regardless of how many channels are utilized
- 10-pin MSOP with ePad package

Applications

- Billboard displays
- Marquee displays
- Instrument displays
- LCD display modules

Typical Application

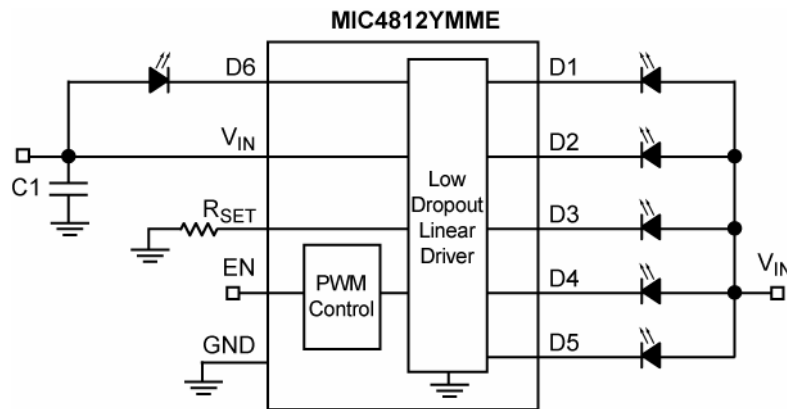

High Current Lighting (Six WLEDs)

Ultra Fast PWM, DAM and Dynamic Average Matching are trademark of Micrel, Inc.

Micrel Inc. • 2180 Fortune Drive • San Jose, CA 95131 • USA • tel +1 (408) 944-0800 • fax + 1 (408) 474-1000 • <http://www.micrel.com>

Ordering Information

Part Number	Mark Code	Junction Temperature Range	Package
MIC4812YMME	4812	-40°C to +125°C	10-Pin ePad MSOP

Pin Configuration

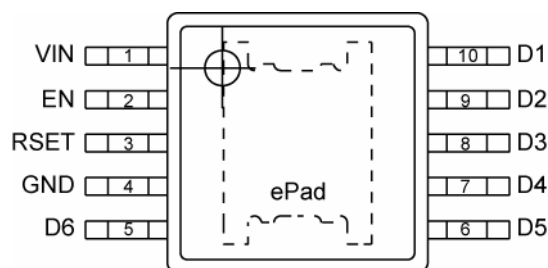

10-Pin ePad MSOP (MME)
(Top View)

Pin Description

Pin Number	Pin Name	Pin Function
1	VIN	Voltage Input. Connect at least 2.2 μ F ceramic capacitor between VIN and GND.
2	EN	Enable LED drivers. This pin can be used as a PWM input for dimming of WLEDs. Do not leave floating.
3	RSET	An internal 1.27V reference sets the nominal maximum WLED current. Example, apply a 8.25k Ω resistor between RSET and GND to set LED current to 100mA at 100% duty cycle.
4	GND	Ground.
5	D6	LED6 driver input. Connect LED anode to VIN and cathode to this pin.
6	D5	LED5 driver input. Connect LED anode to VIN and cathode to this pin.
7	D4	LED4 driver input. Connect LED anode to VIN and cathode to this pin.
8	D3	LED3 driver input. Connect LED anode to VIN and cathode to this pin.
9	D2	LED2 driver input. Connect LED anode to VIN and cathode to this pin.
10	D1	LED1 driver input. Connect LED anode to VIN and cathode to this pin.
ePad	HS PAD	Heat sink pad. Not internally connected. Connect to ground.

Absolute Maximum Ratings⁽¹⁾

Main Input Voltage (V_{IN})	-0.3V to +6V
Enable Input Voltage (V_{EN})	-0.3V to +6V
LED Driver Voltage (V_{D1-D6})	-0.3V to +6V
Power Dissipation	Internally Limited
Lead Temperature (soldering, 10sec.)	260°C
Storage Temperature (T_s)	-65°C to +150°C
ESD Rating ⁽³⁾	1.5kV

Operating Ratings⁽²⁾

Supply Voltage (V_{IN})	+3.0V to +5.5V
Enable Input Voltage (V_{EN})	0V to V_{IN}
LED Driver Voltage (V_{D1-D6})	0V to V_{IN}
Junction Temperature (T_J)	-40°C to +125°C
Junction Thermal Resistance	
ePad MSOP-10L (θ_{JA})	76.7°C/W

Electrical Characteristics

$V_{IN} = V_{EN} = 5V$, $R_{SET} = 8.25k\Omega$; $V_{D1-D6} = 1.2V$; $T_J = 25^\circ C$, **bold** values indicate $-40^\circ C \leq T_J \leq 125^\circ C$; unless noted.

Parameter	Conditions	Min	Typ	Max	Units
Current Accuracy ⁽⁴⁾		96	101	106	mA
Matching ⁽⁵⁾			1	3.6	%
Drop-out	Where $I_{LED} = 90\%$ of LED current seen at $V_{DROPNOM} = 1.2V$, 100% brightness level		190	320	mV
Ground/Supply Bias Current			3.2	4.2	mA
Shutdown Current	$V_{EN} = 0V$		0.01	1	μA
PWM Dimming					
Enable Input Voltage (V_{EN})	Logic Low			0.2	V
	Logic High	1.2			V
Enable Input Current	$V_{IH} \geq 1.2V$		0.01	1	μA
Current Source Delay (50% levels)	Shutdown to on		40	60	μs
	Standby to on		1		μs
	On to Standby		0.3		μs
Current Source Transient Time (10%-90%)	T_{RISE}		1		μs
	T_{FALL}		0.3		μs
Stand-by to Shutdown Time	$V_{EN} = 0V$	10	20	40	ms

Notes:

1. Exceeding the absolute maximum rating may damage the device.
2. The device is not guaranteed to function outside its operating rating.
3. Devices are ESD sensitive. Handling precautions recommended. Human body model, 1.5k Ω in series with 100pF.
4. As determined by average current of all channels in use and all channels loaded.
5. The current through each LED meets the stated limits from the average current of all LEDs.

Typical Characteristics

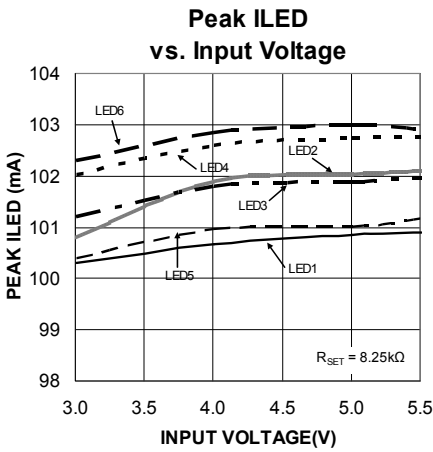
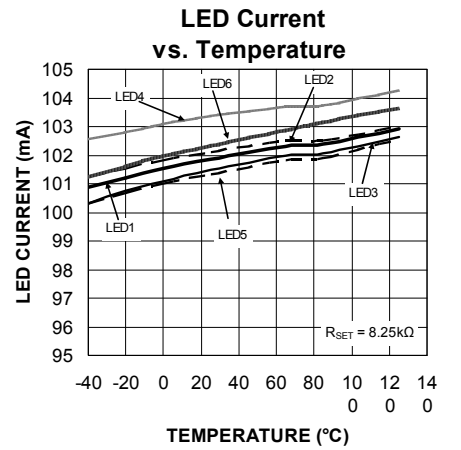
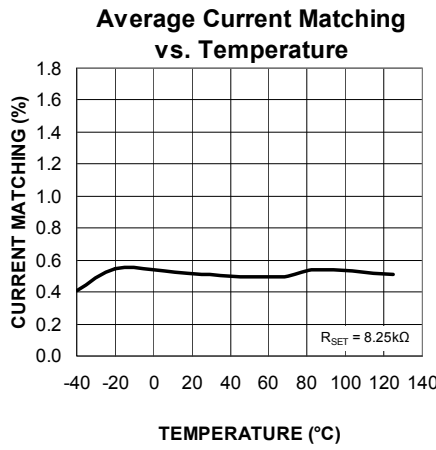
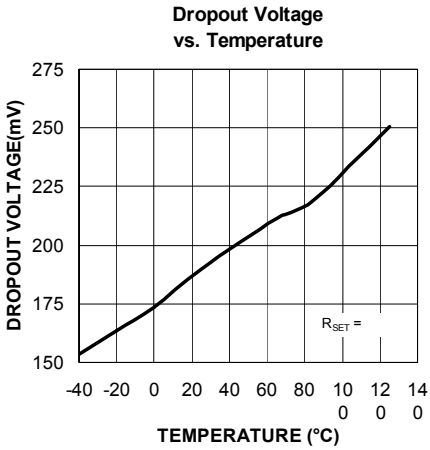
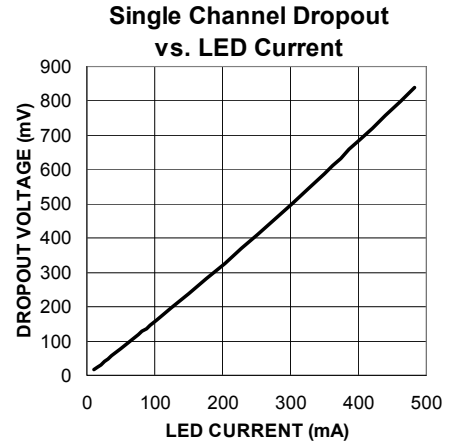
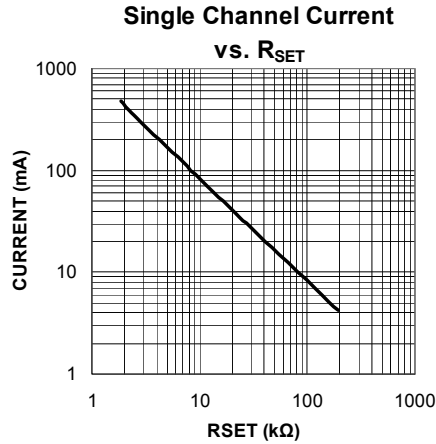
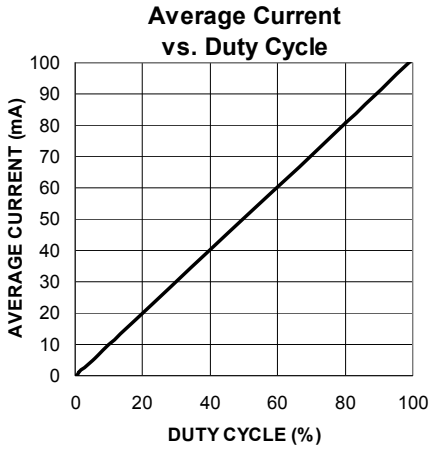

Functional Characteristics

LED Startup into 10% Duty Cycle

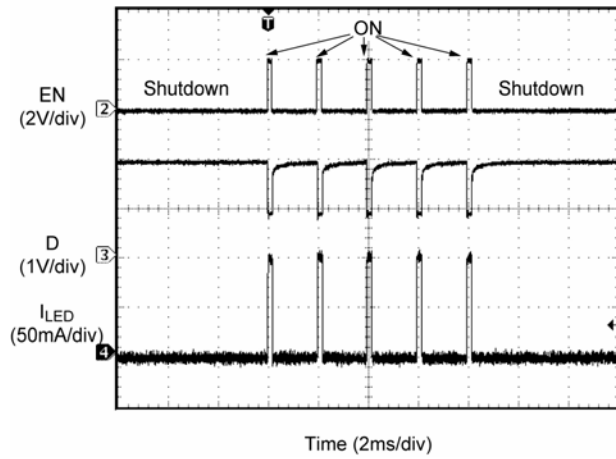

Shutdown to ON

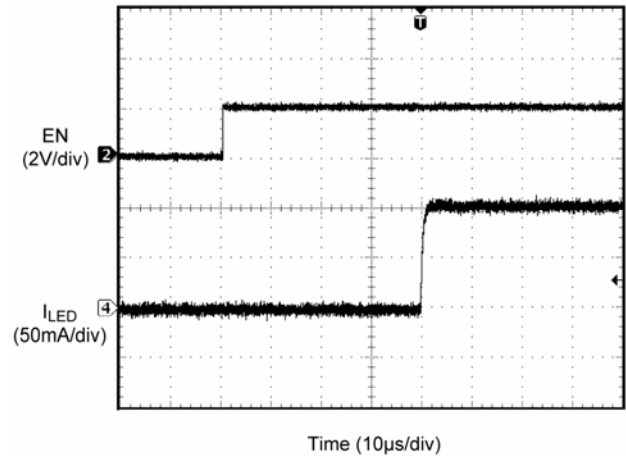

Standby to ON

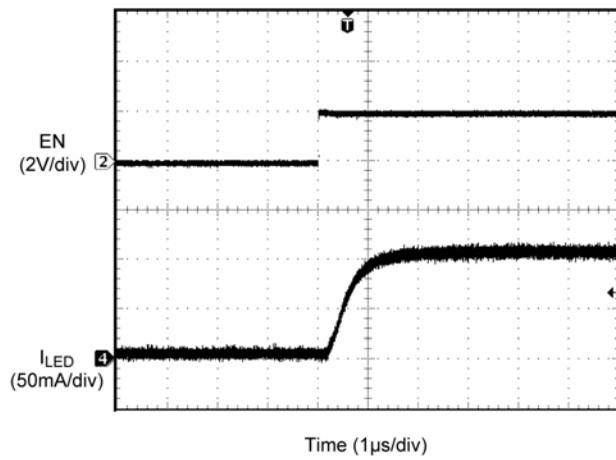

ON to Standby

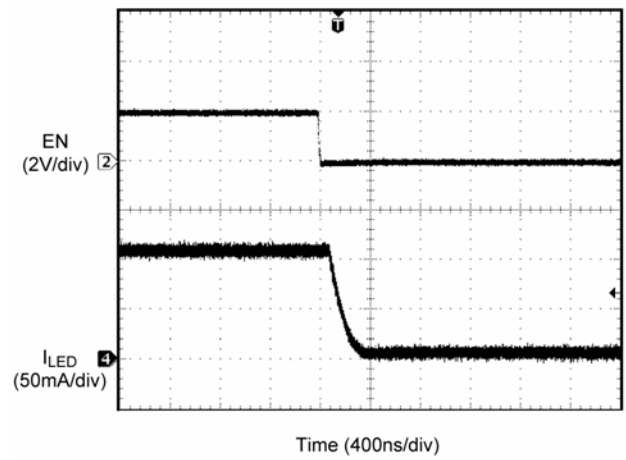

ON to Shutdown

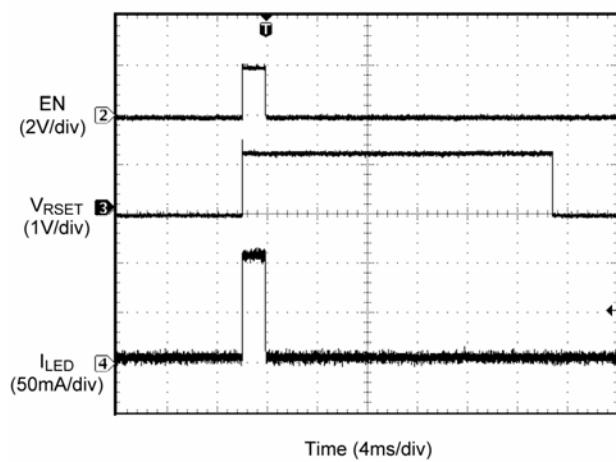

Functional Diagram

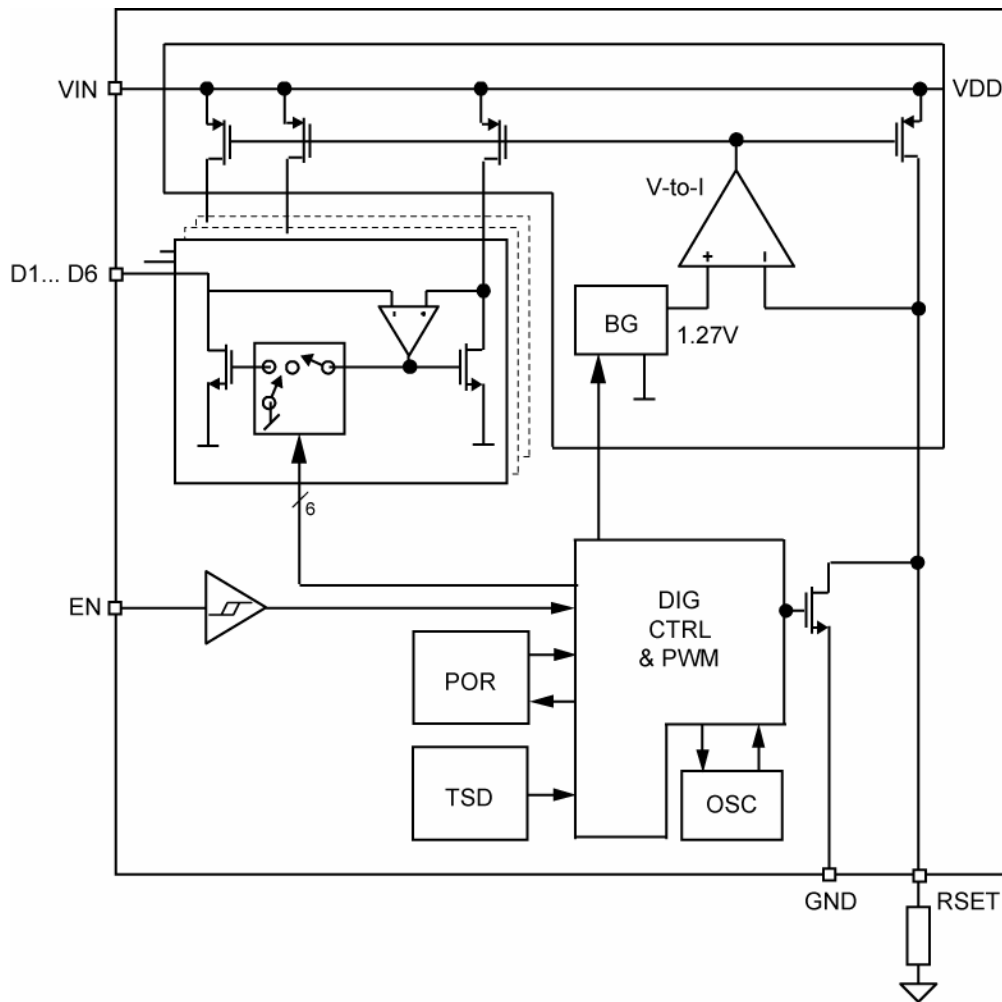

Figure 1. MIC4812 Functional Block Diagram

Functional Description

The MIC4812 is a six channel linear WLED driver. The WLED driver is designed to maintain proper current regulation with LED current accuracy of 1%, and typical matching of 1% across the six channels. The WLEDs are driven independently from the input supply and will maintain regulation with a dropout of 190mV at 100mA. The low dropout allows the WLEDs to be driven directly from the battery voltage and eliminates the need for large and inefficient charge pumps. The maximum WLED current for each channel is set by the external R_{SET} resistor. Dimming is controlled by applying a PWM signal to the EN pin. The MIC4812 accommodates a wide PWM frequency range as outlined in the application information section.

Block Diagram

As shown in Figure 1, the MIC4812 consists of six current mirrors set to copy a master current determined by the R_{SET} resistor. The linear drivers have a designated control block for enabling and dimming the WLEDs.

V_{IN}

The input supply (V_{IN}) provides power to the linear drivers and the control circuitry. The V_{IN} operating range is 3V to 5.5V. A bypass capacitor of 2.2 μ F should be placed close to input (V_{IN}) pin and the ground (GND) pin. Refer to the layout recommendations section for details on placing the input capacitor (C1).

EN

The EN pin is equivalent to the enable pin for the linear drivers on the MIC4812. It can also be used for dimming using a PWM signal. See the PWM Dimming Interface in the Application Information section for details. Pulling the EN low for more than 20ms puts the MIC4812 into a low Iq sleep mode. The EN pin cannot be left floating; a floating enable pin may cause an indeterminate state on the outputs.

The first pulse on the EN pin must be equal or greater to 60 μ s to wake the part up in a known state. This equates to 3.3KHz PWM signal at equal or greater than 50% duty cycle. Higher PWM frequencies may be used but the first pulse must be equal or greater than 60 μ s.

R_{SET}

The R_{SET} pin is used to set the peak current of the linear driver by connecting a R_{SET} resistor to ground. The average LED current can be calculated by equation (1):

$$R_{SET} [k\Omega] = (820 / I_{LED} [mA]) + 0.139 \quad (1)$$

A plot of I_{LED} versus R_{SET} is shown in Figure 2.

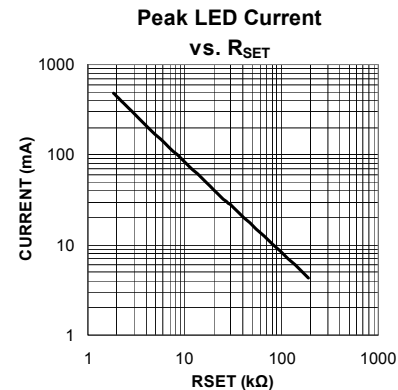

Figure 2. Peak LED Current vs. R_{SET}

D1-D6

The D1 through D6 pins are the linear driver inputs for WLED 1 through 6, respectively. Connect the anodes of the WLEDs to V_{IN} and each cathode of the WLEDs to D1 through D6. When operating with less than six WLEDs, leave the unused D pins unconnected. The linear drivers are extremely versatile in that they may be used in any combinations, for example D1 thru D6 leaving D5 unconnected or paralleled for higher current applications.

GND

The ground pin is the ground path for the linear drivers. The current loop for the ground should be as small as possible. The ground of the input capacitor should be routed with low impedance traces to the GND pin and made as short as possible. Refer to the layout recommendations for more details.

Application Information

Dynamic Average Matching (DAM™)

The Dynamic average matching architecture multiplexes four voltage references to provide highly accurate LED current and channel matching. The MIC4812 achieves industry leading LED channel matching of 1% across the entire dimming range.

Ultra Fast PWM™ Dimming Interface

The MIC4812 supports a wide range of PWM control signal frequencies from 200Hz to 500kHz. This extremely wide range of control provides ultimate flexibility for handheld applications using high frequency PWM control signals.

WLED dimming is achieved by pulse width modulating the linear drivers which are controlled by a PWM signal to the EN pin. For PWM frequencies between 200Hz – 20kHz the MIC4812 supports a duty cycle range from 1% to 100%, see Figure 3. The MIC4812 incorporates an internal shutdown delay to ensure that the internal control circuitry remains active during PWM dimming. This feature prevents the possibility of backlight flickering when using low frequency PWM control signals. The MIC4812 also supports Ultra Fast PWM™ frequencies from 20kHz to 500kHz. Due to input signal propagation delay, PWM frequencies above 20kHz have a non-linear relationship between the duty cycle and the average LED current, see Figures 4 and 5. Figures 6 through 10 show the WLED current response when a PWM signal is applied to the END pin ⁽¹⁾.

⁽¹⁾ From the low Iq sleep mode higher PWM frequencies may require a logic high enable signal for 60µs to first enable the MIC4812 prior to PWM dimming.

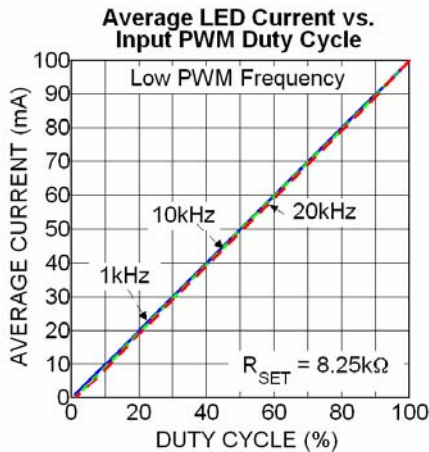

Figure 3. Average Current per LED Dimming by Changing PWM Duty Cycle for PWM Frequencies up to 20kHz

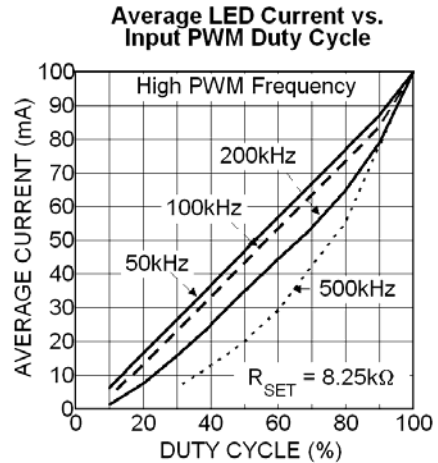

Figure 4. Channel Current Response to PWM Control Signal Frequencies from 50kHz to 500kHz

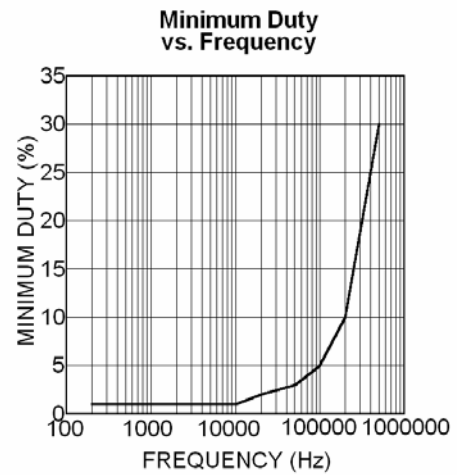

Figure 5. Minimum Duty Cycle for Varying PWM Frequency

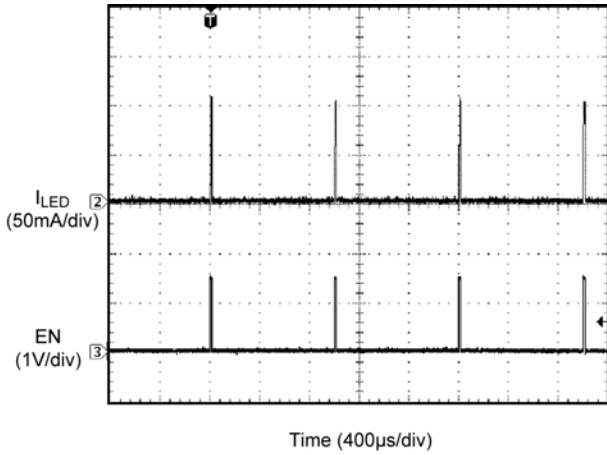

Figure 6. PWM Signal at 1% Duty Cycle ($I_{avg} = 1mA$)

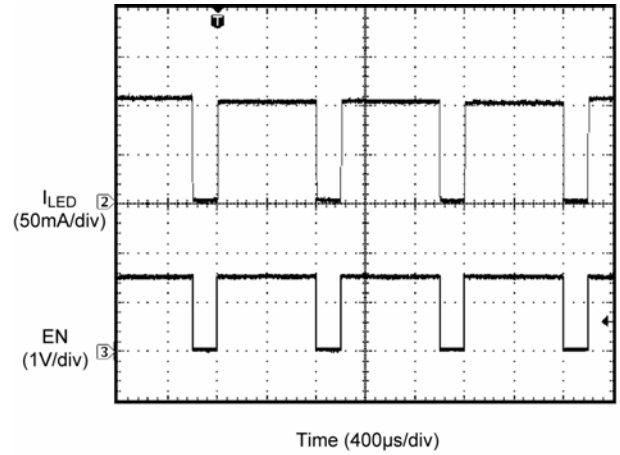

Figure 9. PWM Signal at 80% Duty Cycle ($I_{avg} = 80mA$)

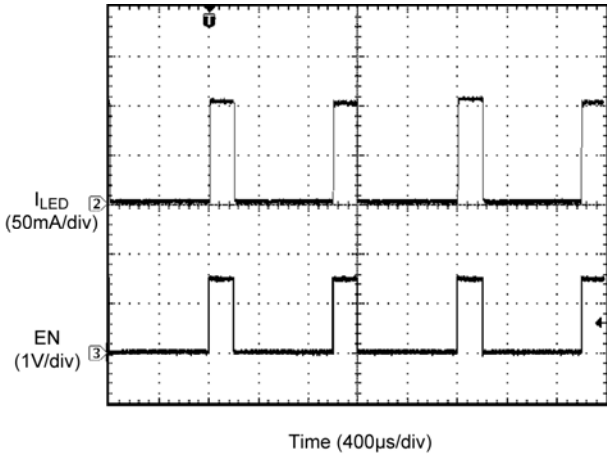

Figure 7. PWM Signal at 20% Duty Cycle ($I_{avg} = 20mA$)

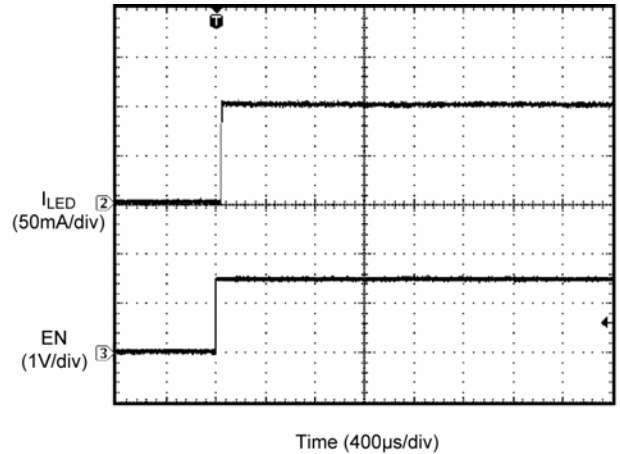

Figure 10. PWM Signal at 100% Duty Cycle ($I_{avg} = 100mA$)

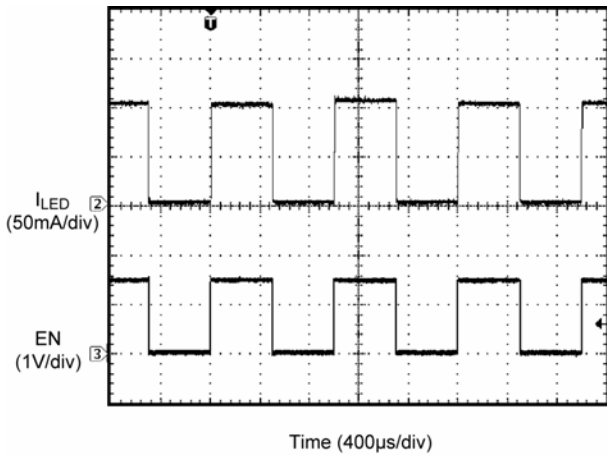
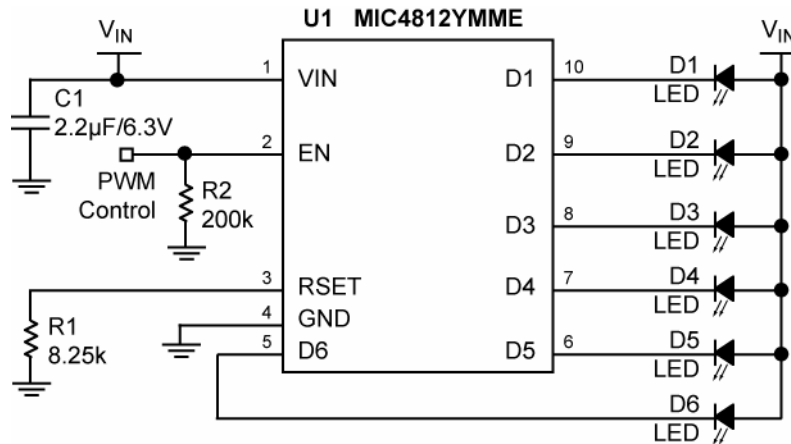

Figure 8. PWM Signal at 50% Duty Cycle ($I_{avg} = 50mA$)

Input Capacitor

The MIC4812 is a high-performance, high bandwidth device. Stability can be maintained using a ceramic input capacitor of 2.2µF. Low-ESR ceramic capacitors provide optimal performance at a minimum amount of space. X5R or X7R dielectrics are recommended for the input capacitor. Y5V dielectrics lose most of their capacitance over temperature and are therefore, not recommended.

MIC4812 Typical Application Circuit



Bill of Materials

Item	Part Number	Manufacturer	Description	Qty.
C1	C1608X5R0J225K	TDK ⁽¹⁾	Ceramic Capacitor, 2.2µF, 6.3V, X5R, Size 0603	1
	06036D225KAT2A	AVX ⁽²⁾		
	GRM188R60J225KE19D	Murata ⁽³⁾		
	VJ0603G225KXYAT	Vishay ⁽⁴⁾		
D1 – D6	OVS5WBCR4	OPTEK Technology, Inc ⁽⁵⁾	WLED	6
R1	CRCW06038K25F5EA	Vishay ⁽⁴⁾	Resistor, 8.25k, 1%, 1/16W, Size 0603	1
R2	CRCW06032003FKEA	Vishay ⁽⁴⁾	Resistor, 200k, 1%, 1/16W, Size 0603	1
U1	MIC4812YMME	Micrel, Inc. ⁽⁶⁾	High Current 6 Channel Linear WLED Driver with DAM™ and Ultra Fast PWM™ Control	1

Notes:

1. TDK: www.tdk.com
2. AVX: www.avx.com
3. Murata: www.murata.com
4. Vishay: www.vishay.com
5. OPTEK: www.optekinc.com
6. Micrel, Inc.: www.micrel.com

PCB Layout Recommendations

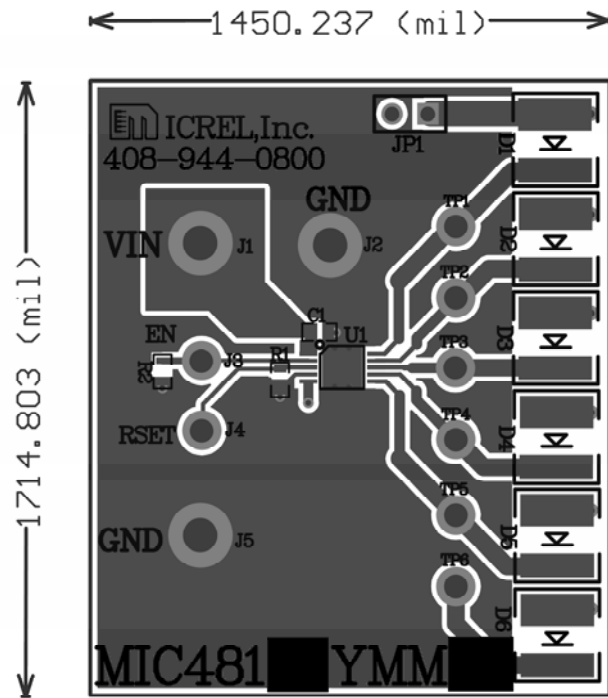

Top Layer

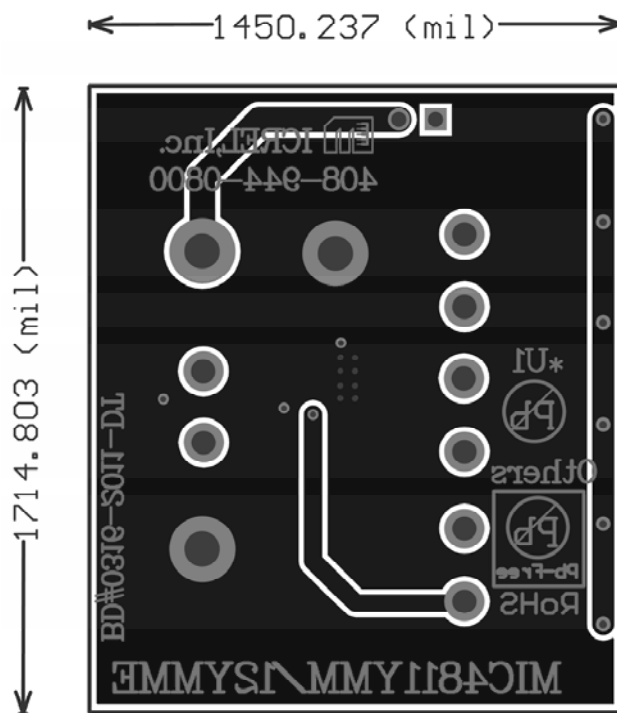

Bottom Layer

Package Information

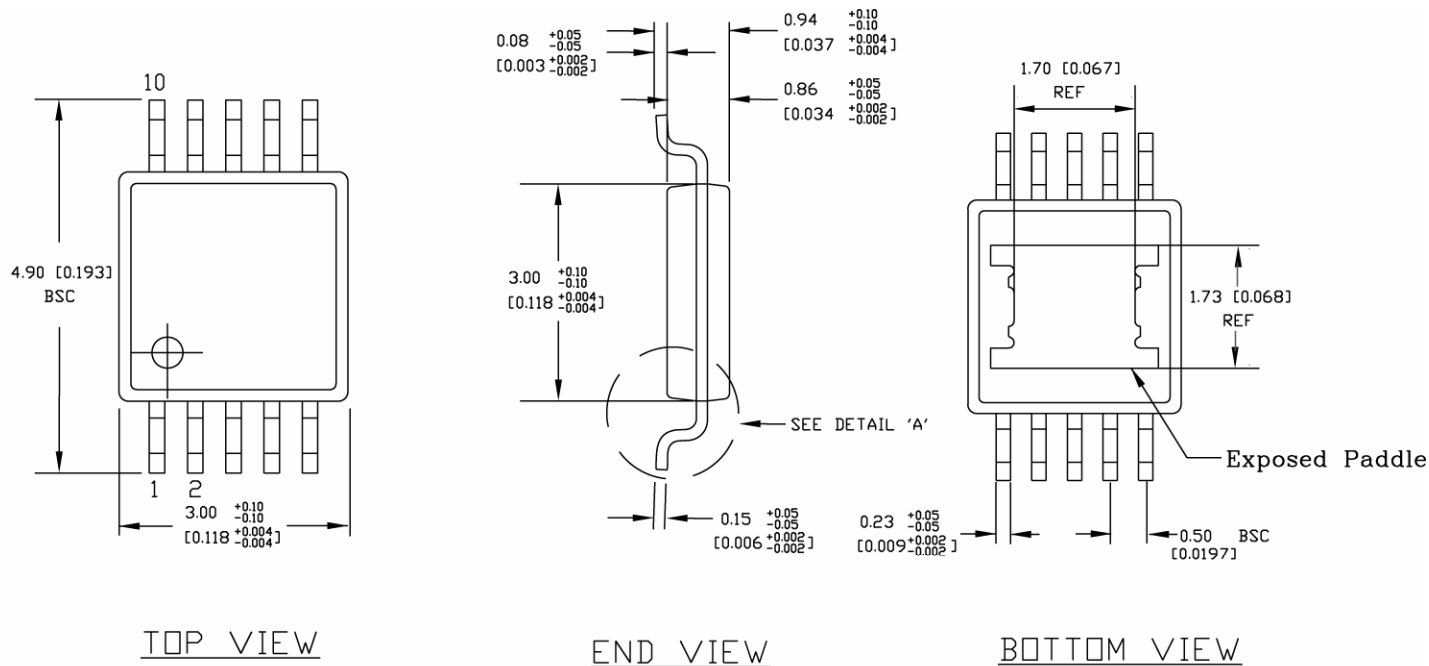

NOTES:

1. DIMENSIONS ARE IN MM [INCHES].
2. CONTROLLING DIMENSION: MM
3. DIMENSION DOES NOT INCLUDE MOLD FLASH OR PROTRUSIONS, EITHER OF WHICH SHALL NOT EXCEED 0.20 [0.008] PER SIDE.

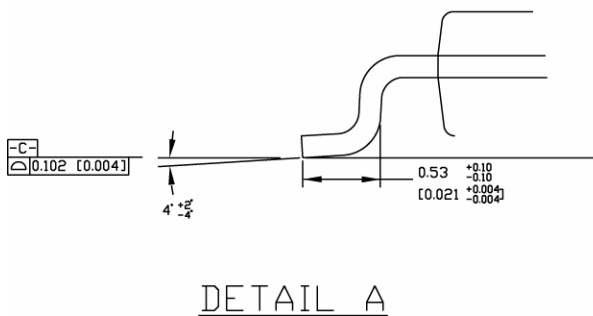

10-Pin EPAD MSOP (MME)

MICREL, INC. 2180 FORTUNE DRIVE SAN JOSE, CA 95131 USA
 TEL +1 (408) 944-0800 FAX +1 (408) 474-1000 WEB <http://www.micrel.com>

Micrel makes no representations or warranties with respect to the accuracy or completeness of the information furnished in this data sheet. This information is not intended as a warranty and Micrel does not assume responsibility for its use. Micrel reserves the right to change circuitry, specifications and descriptions at any time without notice. No license, whether express, implied, arising by estoppel or otherwise, to any intellectual property rights is granted by this document. Except as provided in Micrel's terms and conditions of sale for such products, Micrel assumes no liability whatsoever, and Micrel disclaims any express or implied warranty relating to the sale and/or use of Micrel products including liability or warranties relating to fitness for a particular purpose, merchantability, or infringement of any patent, copyright or other intellectual property right.

Micrel Products are not designed or authorized for use as components in life support appliances, devices or systems where malfunction of a product can reasonably be expected to result in personal injury. Life support devices or systems are devices or systems that (a) are intended for surgical implant into the body or (b) support or sustain life, and whose failure to perform can be reasonably expected to result in a significant injury to the user. A Purchaser's use or sale of Micrel Products for use in life support appliances, devices or systems is a Purchaser's own risk and Purchaser agrees to fully indemnify Micrel for any damages resulting from such use or sale.

Компания «Океан Электроники» предлагает заключение долгосрочных отношений при поставках импортных электронных компонентов на взаимовыгодных условиях!

Наши преимущества:

- Поставка оригинальных импортных электронных компонентов напрямую с производств Америки, Европы и Азии, а так же с крупнейших складов мира;
- Широкая линейка поставок активных и пассивных импортных электронных компонентов (более 30 млн. наименований);
- Поставка сложных, дефицитных, либо снятых с производства позиций;
- Оперативные сроки поставки под заказ (от 5 рабочих дней);
- Экспресс доставка в любую точку России;
- Помощь Конструкторского Отдела и консультации квалифицированных инженеров;
- Техническая поддержка проекта, помощь в подборе аналогов, поставка прототипов;
- Поставка электронных компонентов под контролем ВП;
- Система менеджмента качества сертифицирована по Международному стандарту ISO 9001;
- При необходимости вся продукция военного и аэрокосмического назначения проходит испытания и сертификацию в лаборатории (по согласованию с заказчиком);
- Поставка специализированных компонентов военного и аэрокосмического уровня качества (Xilinx, Altera, Analog Devices, Intersil, Interpoint, Microsemi, Actel, Aeroflex, Peregrine, VPT, Syfer, Eurofarad, Texas Instruments, MS Kennedy, Miteq, Cobham, E2V, MA-COM, Hittite, Mini-Circuits, General Dynamics и др.);

Компания «Океан Электроники» является официальным дистрибьютором и эксклюзивным представителем в России одного из крупнейших производителей разъемов военного и аэрокосмического назначения «**JONHON**», а так же официальным дистрибьютором и эксклюзивным представителем в России производителя высокотехнологичных и надежных решений для передачи СВЧ сигналов «**FORSTAR**».



JONHON

«**JONHON**» (основан в 1970 г.)

Разъемы специального, военного и аэрокосмического назначения:

(Применяются в военной, авиационной, аэрокосмической, морской, железнодорожной, горно- и нефтедобывающей отраслях промышленности)

«**FORSTAR**» (основан в 1998 г.)

ВЧ соединители, коаксиальные кабели,
кабельные сборки и микроволновые компоненты:

(Применяются в телекоммуникациях гражданского и специального назначения, в средствах связи, РЛС, а так же военной, авиационной и аэрокосмической отраслях промышленности).



Телефон: 8 (812) 309-75-97 (многоканальный)

Факс: 8 (812) 320-03-32

Электронная почта: ocean@oceanchips.ru

Web: <http://oceanchips.ru/>

Адрес: 198099, г. Санкт-Петербург, ул. Калинина, д. 2, корп. 4, лит. А