

## Compact Headphone Amplifiers

# Standard Headphone Amplifiers

BH3544F, BH3547F, BH3548F

No.11102EBT02



### ●Description

BH3544F, BH3547F, BH3548F are headphone amplifiers suitable for portable products. BH3544F, BH3547F, BH3548F has a fixed gain of 6 dB. External resistors for gain setting are not needed. Package of BH3544F, BH3547F, BH3548F is pin-to-pin compatible (SOP8), enable to replace each other easily.

BH3544F, BH3547F, BH3548F also has mute functions that make it easy to prevent pop noise when power supply turns on/off. Moreover, thermal shutdown function is built-in. BH3544F, BH3547F can drive 16/32Ω load, BH3548F can drive 8/16/32Ω. So, BH3548F is suitable for 8Ω receiver.

### ●Features

- 1) Built-in mute function for preventing pop noise when power supply turns on/off
- 2) Built-in thermal shutdown function
- 3) BH3544F, BH3547F, BH3548F are pin-to-pin compatible
- 4) SOP8 small package

### ●Applications

TV, Desktop PC, Notebook PC, Camcorder and other equipment having headphone output

### ●Line up

Part No.	BH3544F	BH3547F	BH3548F	Unit
Supply voltage	+2.8 ~ +6.5	+4.5 ~ +5.5	+4.0 ~ +5.5	V
Quiescent current	7.0	3.7	6.5	mA
Amplifier gain	6			dB
Output [RL=16Ω]	62	77	62	mW
load impedance	16 / 32		8/16/32	Ω
Operating temperature range	-25 ~ +75		-40 ~ +85	°C

### ●Absolute maximum ratings(Ta=25°C)

Parameter	Symbol	Ratings	Unit
		BH3544F, BH3547F, BH3548F	
Applied voltage	VCC	7.0	V
Power dissipation	Pd	550 <sup>*1</sup>	mW
Storage temperature	Tstg	-55~+125	°C

\*1 Derating is done at 5.5mW/°C above Ta=25°C. (When mounted on a 70mm×70mm×1.6mm PCB board, FR4)

### ●Operating conditions (Ta=25°C)

Parameter	Symbol	Limits			Unit
		BH3544F	BH3547F	BH3548F	
Supply voltage	VCC	+2.8 ~ +6.5	+4.5 ~ +6.5	+4.0 ~ +5.5	V
Temperature Range	Topr	-25~+75		-40 ~ +85	°C

\* These product are not designed for protection against radioactive rays.

●Electrical characteristics (Unless otherwise noted,  $T_a=25^\circ\text{C}$ ,  $V_{CC}=5\text{V}$ ,  $R_L=32\Omega$ ,  $f=1\text{kHz}$ ,  $BW=400\sim 30\text{kHz}$ ,  $V_{IN}=-6\text{dBV}$ )

Parameter	Symbol	Limits(TYP.)			Unit	Conditions
		BH3544F	BH3547F	BH3548F		
Quiescent current	$I_Q$	7	3.7	6.5	mA	$V_{IN}=0\text{Vrms}$
Mute pin control voltage H	$V_{TMH}$	1.6<			V	Mute OFF
Mute pin control voltage L	$V_{TML}$	<0.3			V	Mute ON
Gain	GVC	6			dB	-
Gain difference between channels	$\Delta G_{VC}$	0			dB	-
Total harmonic distortion	THD	0.02	0.05	0.02	%	$BW=20\sim 20\text{kHz}$
Rated output 1	$P_{O1}$	31	46	31	mW	$R_L=32\Omega$ , THD<0.1% (BH3544F, BH3548F) $R_L=32\Omega$ , THD<0.3% (BH3547F)
Rated output 2	$P_{O2}$	62	77	62	mW	$R_L=16\Omega$ , THD<0.1% (BH3544F, BH3548F) $R_L=16\Omega$ , THD<0.5% (BH3547F)
Rated output 3	$P_{O3}$	-		120	mW	$R_L=8\Omega$ , THD<0.25% (BH3548F)
Output noise voltage	$V_{NO}$	-93			dBV	$BW=20\sim 20\text{kHz}$ , $R_g=0\Omega$
Channel separation	CS	-90	-87	-90	dB	$R_g=0\Omega$
Mute attenuation	ATT	-80			dB	$R_g=0\Omega$
Ripple rejection	RR	-57			dB	$f_{RR}=100\text{Hz}$ , $V_{RR}=-20\text{dBV}$
Input resistance	$R_{in}$	90			k $\Omega$	-

●Reference data

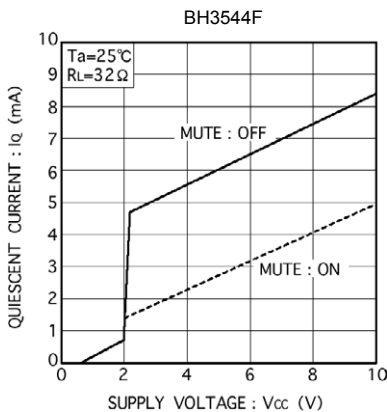

Fig. 1 Quiescent current vs. power supply voltage

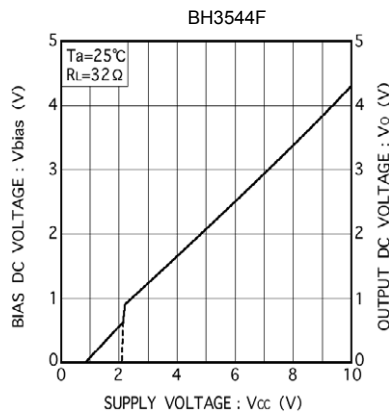

Fig. 2 in DC current vs. power supply voltage

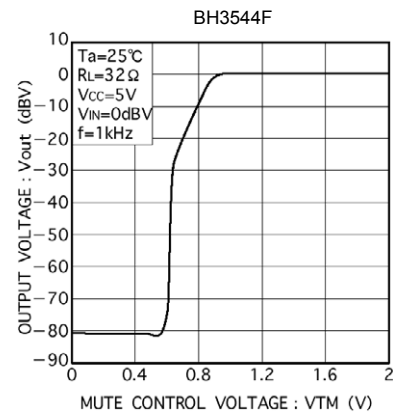

Fig. 3 Output voltage vs. Mute control voltage

●Reference data (Continued)

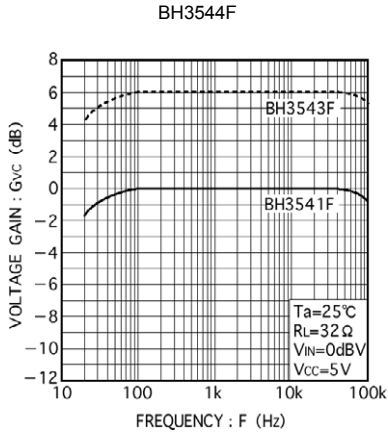

Fig. 4 Voltage gain vs. frequency

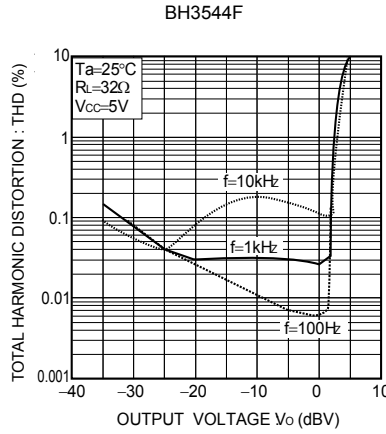

Fig. 5 Total harmonic distortion vs. output voltage (1)

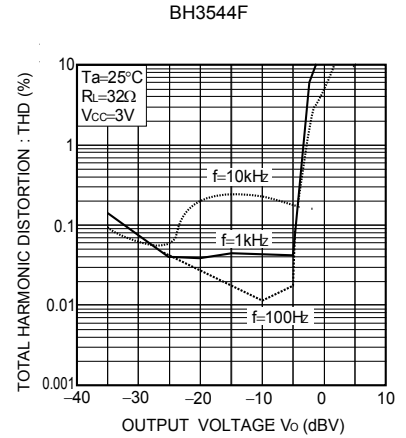

Fig. 6 Total harmonic distortion vs. output voltage (2)

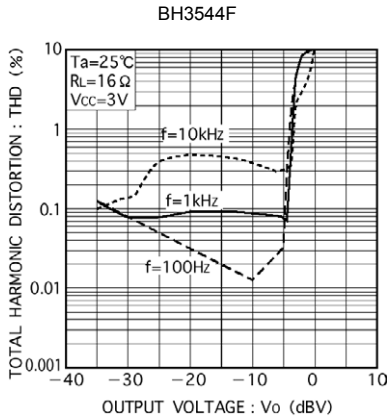

Fig. 7 Total harmonic distortion vs. output voltage (3)

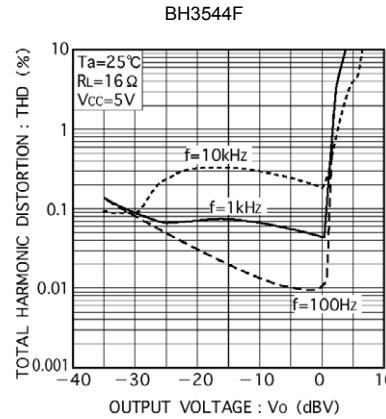

Fig. 8 Total harmonic distortion vs. output voltage (4)

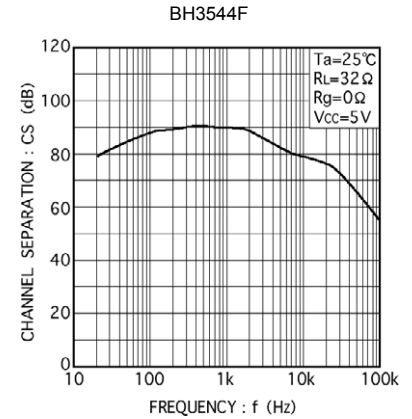

Fig. 9 Channel separation vs. frequency

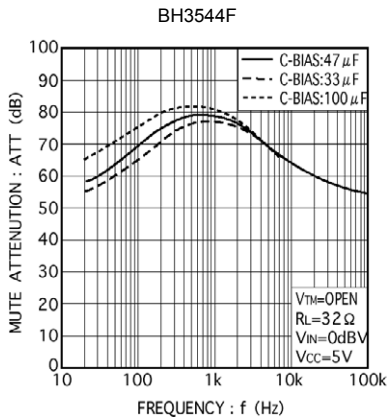

Fig. 10 MUTE attenuation vs. frequency

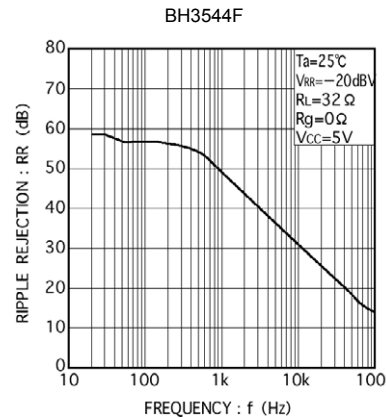

Fig. 11 Ripple rejection vs. frequency

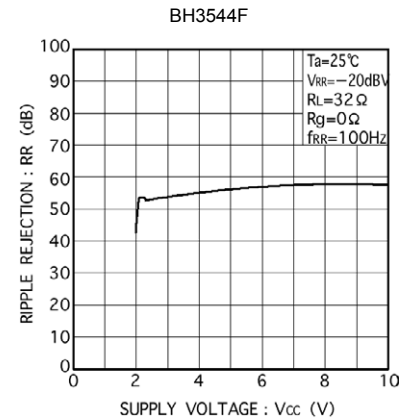

Fig. 12 Ripple rejection vs. power supply voltage

●Block diagram

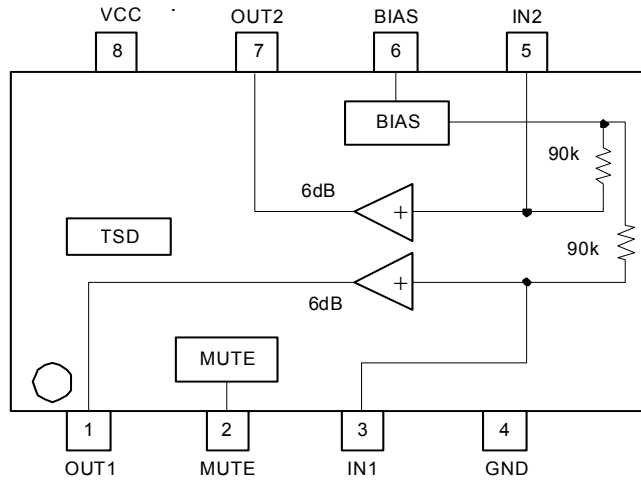

Fig. 13

●Measurement circuit

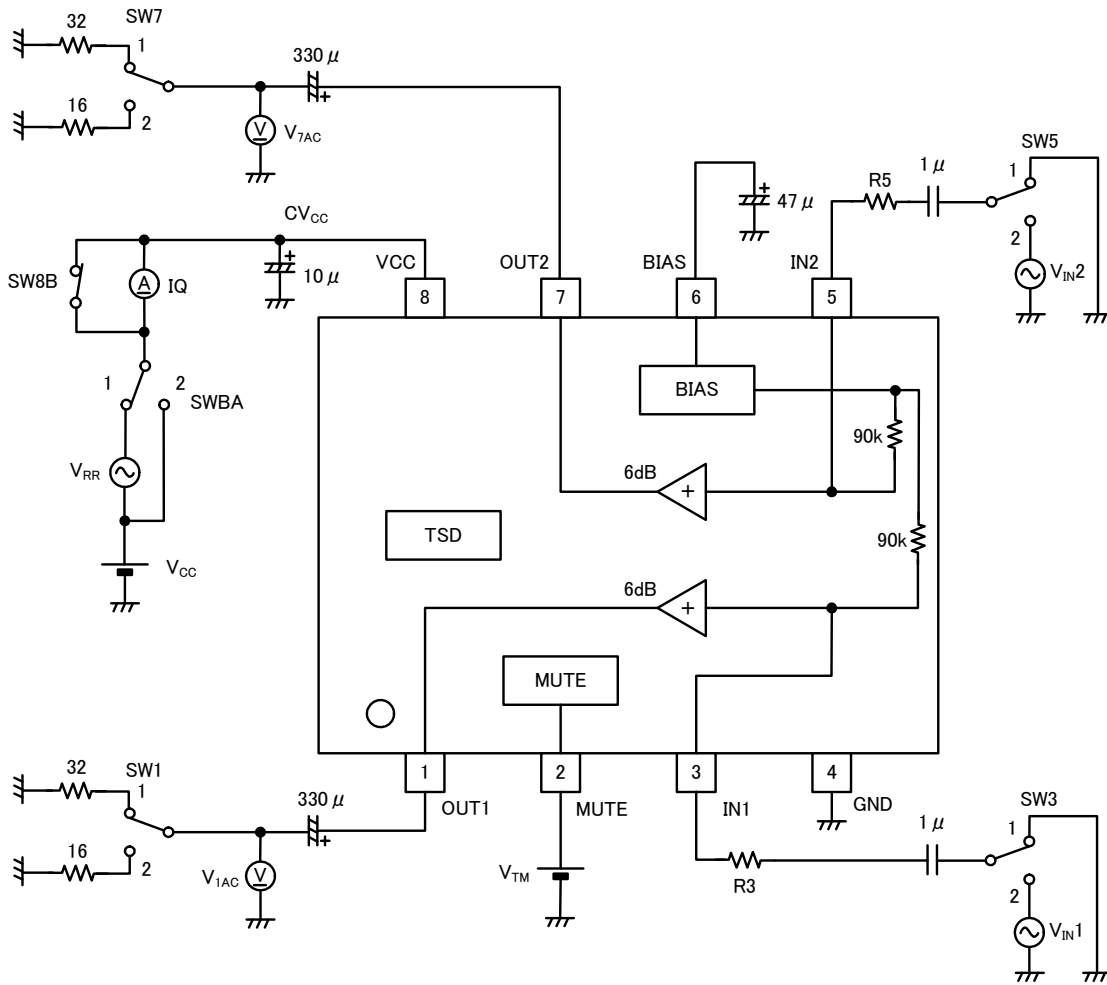
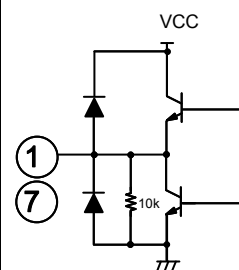
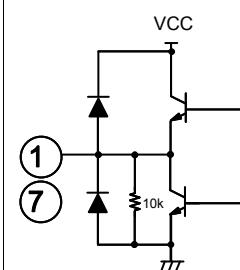
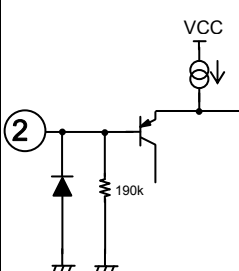
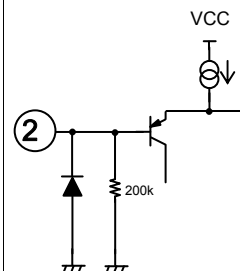
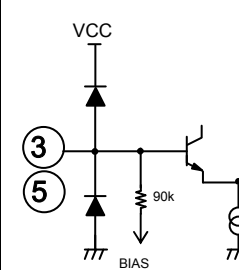
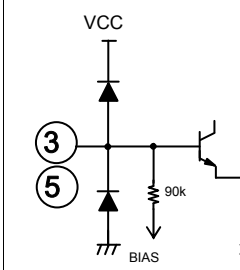
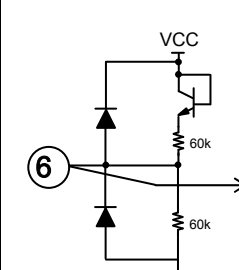
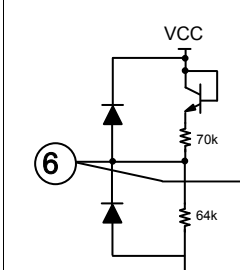

Fig. 14

● Terminal Equivalent Circuit / Description

Pin No.	Pin Name	I/O	Pin voltage	Equivalent circuit		Function
				BH3544F, BH3548F	BH3547F	
1 7	OUT1 OUT2	O	2.1V (VCC=5V)			Output pin
2	MUTE	I	0.1V (When open)			Mute control pin Mute on: Hi Mute off: Lo (open)
3 5	IN1 IN2	I	2.1V (VCC=5V)			Input pin
6	BIAS	I/O	2.1V (VCC=5V)			Bias pin  (Since the 47 μF externally attached capacitor also serves as the time constant for pop noise countermeasures, evaluate adequately when changing it.)
4	GND	I	-	-	-	GND pin
8	VCC	I	-	-	-	Power supply pin

※The figure in the pin explanation and input/output equivalent circuit is reference value, it doesn't guarantee the value.

## ● Application circuit

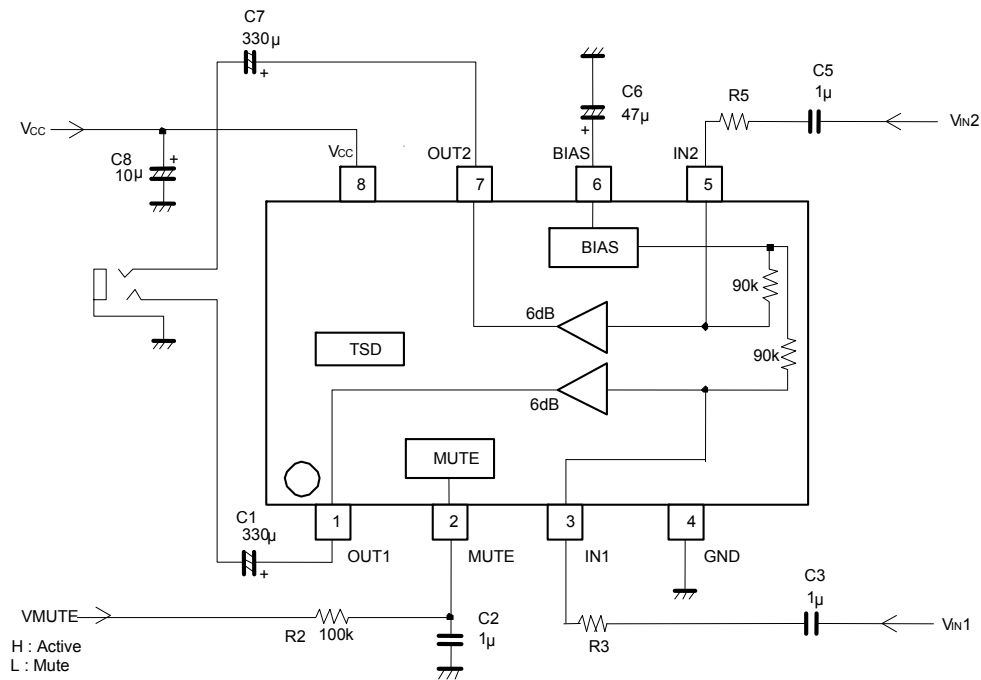

Fig. 15

## ● Description of external components

## 1) Input coupling capacitors (C3, C5)

These are determined according to the lower cutoff frequency  $f_c$ . Moreover, since lowering the capacitance can cause the occurrence of pop noise, when changing this, determine it after adequate checking.

Since the input impedance is  $90\text{k}\Omega$ , these are found by the expressions below, although drift, temperature characteristics, and other considerations are necessary. (Layered ceramic capacitors are recommended.)

$$C3(C5) = 1 / (2\pi \times 90\text{k}\Omega \times f_c)$$

## 2) Bias capacitor (C6)

When  $V_{CC}=5\text{V}$ ,  $47\mu\text{F}$  is recommended. Since lowering the capacitance too much can cause worsening of electrical characteristics or the occurrence of pop noise, when changing this, determine it after checking this adequately.

## 3) Mute pin pop noise countermeasures (R2, C2)

Since BH3544F, BH3548F have an impedance of  $190\text{k}\Omega$  against GND and the BH3547F has  $200\text{k}\Omega$ , it may be impossible to cancel mute mode if R2 is made too large.

## 4) Output coupling capacitors (C1, C7)

These are determined by the lower cutoff frequency. If  $R_L$  is the output load resistance (assuming a resistance  $R_x$  is put in for output protection or current restriction), these are found by the expression below.

$$C1(C7) = 1 / (2\pi \times (R_L + R_x) \times f_c)$$

## 5) Input gain adjustment resistances (R3, R5)

Externally attached resistances (R3, R5) make input gain adjustment possible. The gain found by the expression below can be set.

$$G_{vc} = 6 + 20 \log(90\text{k}\Omega / (90\text{k}\Omega + R3[R5])) \text{ [dB]}$$

When input gain is not accommodated, these resistors have no use.

●Notes for use

- 1) Numbers and data in entries are representative design values and are not guaranteed values of the items.
- 2) Although we are confident in recommending the sample application circuits, carefully check their characteristics further when using them. When modifying externally attached component constants before use, determine them so that they have sufficient margins by taking into account variations in externally attached components and the Rohm LSI, not only for static characteristics but also including transient characteristics.
- 3) Absolute maximum ratings  
If applied voltage, operating temperature range, or other absolute maximum ratings are exceeded, the LSI may be damaged. Do not apply voltages or temperatures that exceed the absolute maximum ratings. If you think of a case in which absolute maximum ratings are exceeded, enforce fuses or other physical safety measures and investigate how not to apply the conditions under which absolute maximum ratings are exceeded to the LSI.
- 4) GND potential  
Make the GND pin voltage such that it is the lowest voltage even when operating below it. Actually confirm that the voltage of each pin does not become a lower voltage than the GND pin, including transient phenomena.
- 5) Thermal design  
Perform thermal design in which there are adequate margins by taking into account the allowable power dissipation in actual states of use.
- 6) Shorts between pins and misinstallation  
When mounting the LSI on a board, pay adequate attention to orientation and placement discrepancies of the LSI. If it is misinstalled and the power is turned on, the LSI may be damaged. It also may be damaged if it is shorted by a foreign substance coming between pins of the LSI or between a pin and a power supply or a pin and a GND.
- 7) Operation in strong magnetic fields  
Adequately evaluate use in a strong magnetic field, since there is a possibility of malfunction.
- 8) Pop noise countermeasures  
In order to prevent the pop noise that occurs when the power supply turns ON or OFF, make the rise and fall with reference to the timing diagram shown below.

1)BH3544F/ BH3548F

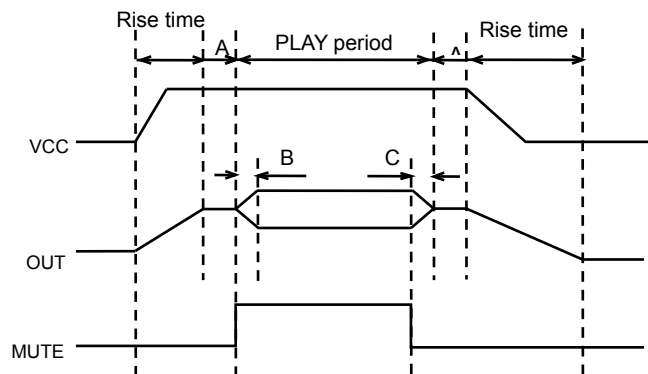

Fig. 16

- (A):Mute period (Use as pop noise countermeasure when power supply turns ON/OFF by making VMUTE=Lo.)
- (B):Mute cancellation period (This has a time constant because it is used by the externally attached C2 and R2 as a pop noise countermeasure on mute cancellation, so be careful of the timing.)
- (C):Mute start time (As on cancellation, this has a time constant.)

2)BH3547F

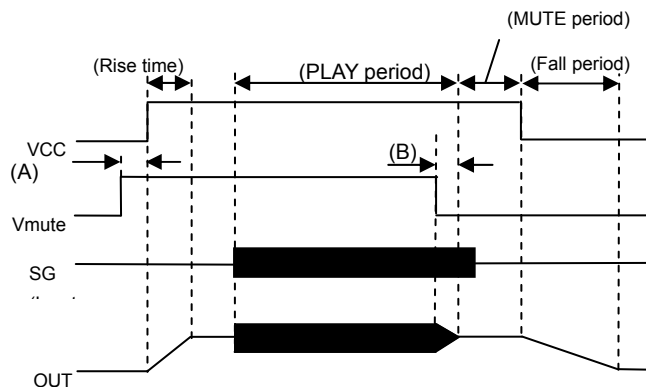
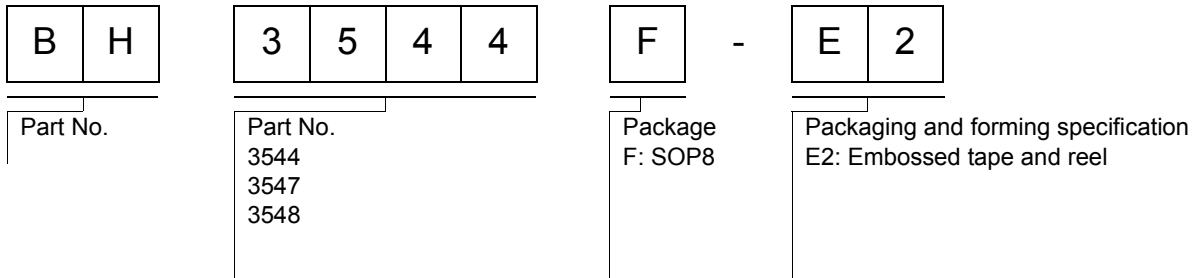

Fig. 17

- (A):Before VCC rise (or at the same time as VCC) make mute cancelled (VMUTE=Hi).
- (B):Soft mute period (This time can be set by externally attached R2 and C2)

● Ordering part number



SOP8

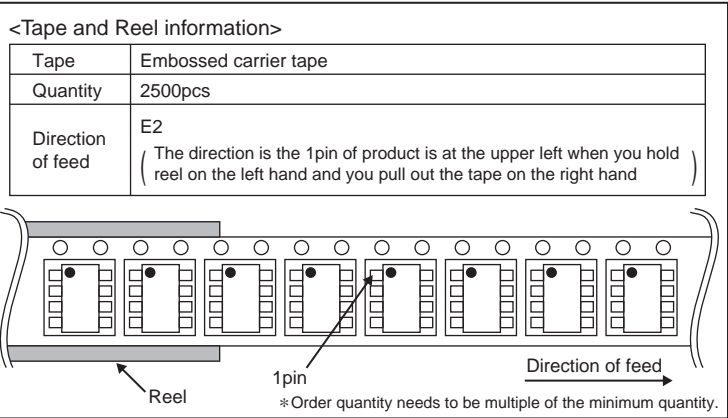
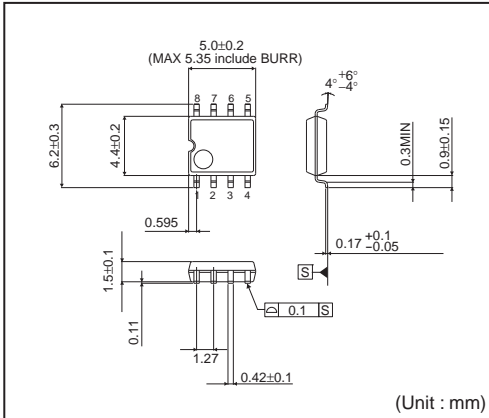



## Notes

No copying or reproduction of this document, in part or in whole, is permitted without the consent of ROHM Co.,Ltd.

The content specified herein is subject to change for improvement without notice.

The content specified herein is for the purpose of introducing ROHM's products (hereinafter "Products"). If you wish to use any such Product, please be sure to refer to the specifications, which can be obtained from ROHM upon request.

Examples of application circuits, circuit constants and any other information contained herein illustrate the standard usage and operations of the Products. The peripheral conditions must be taken into account when designing circuits for mass production.

Great care was taken in ensuring the accuracy of the information specified in this document. However, should you incur any damage arising from any inaccuracy or misprint of such information, ROHM shall bear no responsibility for such damage.

The technical information specified herein is intended only to show the typical functions of and examples of application circuits for the Products. ROHM does not grant you, explicitly or implicitly, any license to use or exercise intellectual property or other rights held by ROHM and other parties. ROHM shall bear no responsibility whatsoever for any dispute arising from the use of such technical information.

The Products specified in this document are intended to be used with general-use electronic equipment or devices (such as audio visual equipment, office-automation equipment, communication devices, electronic appliances and amusement devices).

The Products specified in this document are not designed to be radiation tolerant.

While ROHM always makes efforts to enhance the quality and reliability of its Products, a Product may fail or malfunction for a variety of reasons.

Please be sure to implement in your equipment using the Products safety measures to guard against the possibility of physical injury, fire or any other damage caused in the event of the failure of any Product, such as derating, redundancy, fire control and fail-safe designs. ROHM shall bear no responsibility whatsoever for your use of any Product outside of the prescribed scope or not in accordance with the instruction manual.

The Products are not designed or manufactured to be used with any equipment, device or system which requires an extremely high level of reliability the failure or malfunction of which may result in a direct threat to human life or create a risk of human injury (such as a medical instrument, transportation equipment, aerospace machinery, nuclear-reactor controller, fuel-controller or other safety device). ROHM shall bear no responsibility in any way for use of any of the Products for the above special purposes. If a Product is intended to be used for any such special purpose, please contact a ROHM sales representative before purchasing.

If you intend to export or ship overseas any Product or technology specified herein that may be controlled under the Foreign Exchange and the Foreign Trade Law, you will be required to obtain a license or permit under the Law.



Thank you for your accessing to ROHM product informations.  
More detail product informations and catalogs are available, please contact us.

## ROHM Customer Support System

<http://www.rohm.com/contact/>

Компания «Океан Электроники» предлагает заключение долгосрочных отношений при поставках импортных электронных компонентов на взаимовыгодных условиях!

Наши преимущества:

- Поставка оригинальных импортных электронных компонентов напрямую с производств Америки, Европы и Азии, а так же с крупнейших складов мира;
- Широкая линейка поставок активных и пассивных импортных электронных компонентов (более 30 млн. наименований);
- Поставка сложных, дефицитных, либо снятых с производства позиций;
- Оперативные сроки поставки под заказ (от 5 рабочих дней);
- Экспресс доставка в любую точку России;
- Помощь Конструкторского Отдела и консультации квалифицированных инженеров;
- Техническая поддержка проекта, помощь в подборе аналогов, поставка прототипов;
- Поставка электронных компонентов под контролем ВП;
- Система менеджмента качества сертифицирована по Международному стандарту ISO 9001;
- При необходимости вся продукция военного и аэрокосмического назначения проходит испытания и сертификацию в лаборатории (по согласованию с заказчиком);
- Поставка специализированных компонентов военного и аэрокосмического уровня качества (Xilinx, Altera, Analog Devices, Intersil, Interpoint, Microsemi, Actel, Aeroflex, Peregrine, VPT, Syfer, Eurofarad, Texas Instruments, MS Kennedy, Miteq, Cobham, E2V, MA-COM, Hittite, Mini-Circuits, General Dynamics и др.);

Компания «Океан Электроники» является официальным дистрибьютором и эксклюзивным представителем в России одного из крупнейших производителей разъемов военного и аэрокосмического назначения «JONHON», а так же официальным дистрибьютором и эксклюзивным представителем в России производителя высокотехнологичных и надежных решений для передачи СВЧ сигналов «FORSTAR».



## JONHON

«JONHON» (основан в 1970 г.)

Разъемы специального, военного и аэрокосмического назначения:

(Применяются в военной, авиационной, аэрокосмической, морской, железнодорожной, горно- и нефтедобывающей отраслях промышленности)

«FORSTAR» (основан в 1998 г.)

ВЧ соединители, коаксиальные кабели, кабельные сборки и микроволновые компоненты:

(Применяются в телекоммуникациях гражданского и специального назначения, в средствах связи, РЛС, а так же военной, авиационной и аэрокосмической отраслях промышленности).



Телефон: 8 (812) 309-75-97 (многоканальный)

Факс: 8 (812) 320-03-32

Электронная почта: [ocean@oceanchips.ru](mailto:ocean@oceanchips.ru)

Web: <http://oceanchips.ru/>

Адрес: 198099, г. Санкт-Петербург, ул. Калинина, д. 2, корп. 4, лит. А