

Parallax WX ESP8266 Wi-Fi Modules

DIP (#32420D), or SIP (#32420S)

The Parallax WX Wi-Fi module offers a new way to add Wi-Fi connectivity to your microcontroller projects. It can function as its own wireless access point (AP) or as a station (STA) on another Wi-Fi network, or even both for brief periods of time when joining another network. In either mode, it can serve its own configuration pages as well as user-created web pages that make it possible for devices to interact with a microcontroller through the Wi-Fi module. On Wi-Fi networks configured to allow it to access the Internet, it can also send and receive a variety of TCP/IP messages for Internet of Things (IoT) projects. This module also serves its own firmware upgrade page that allows you to pick and upload the latest open source firmware revision, or even variations that support specific applications as they become available.

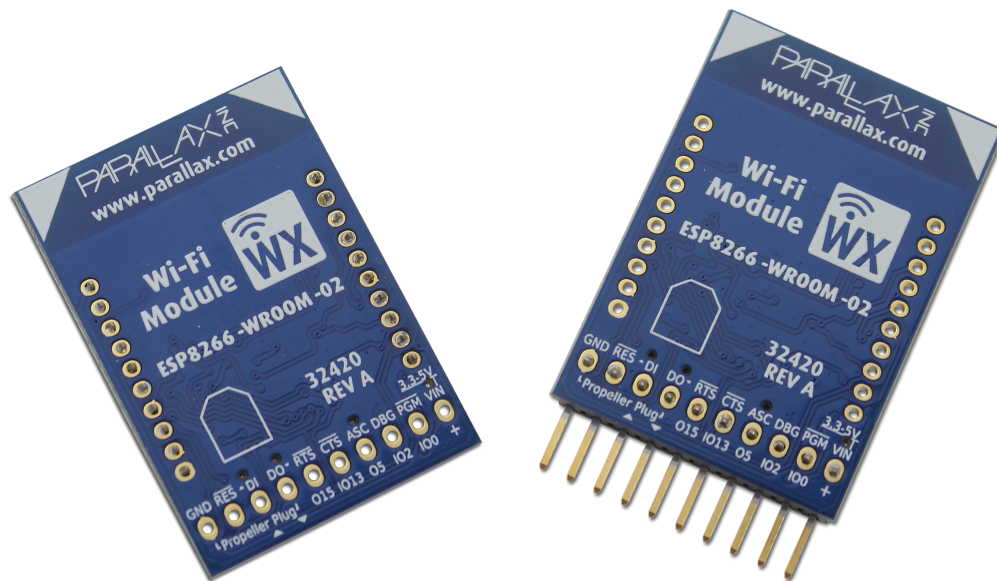

Features

- 32420S (right) - A breadboard-friendly, 5 and 3.3 V compatible 0.1 inch SIP package that works well with the BASIC Stamp, Arduino and Propeller
- 32420D (left) - A 3.3 V, 2 mm DIP package designed to work with the socket on the Propeller Activity Board, both original 32910 and WX #32912. *NOTE: These modules are not compatible with Parallax XBee adapter boards.*

- Supports 2.4 GHz Wi-Fi access through the ESP8266-WROOM-02 module (FCC and CE approved)
- Transparent serial communication mode for wireless microcontroller programming and debugging (Activity Board WX)
- Command serial communication mode for exchanging information with the host microcontroller
- 3 Wi-Fi modes: (AP) as access point that up to four devices can join, (STA) as a station on another Wi-Fi network, and (STA + AP) station plus access point for joining another Wi-Fi network.
- Micro web server allows other devices to access both configuration and user created/uploaded web pages in STA or AP mode.
- Approximately 1 MB of user file system for storing web pages and other content.
- Built-in configuration web pages for settings, networks, file uploads and over the air firmware updates.
- Over the air (OTA) web page uploads via a simple web interface. Upload one or more pages to the module's user file system. The Wi-Fi module will serve those pages to computers and mobile devices that have joined its network (AP) or on the same network with it (STA). This will allow your microcontroller projects to interact with computers, tablets, cell phones, and other devices on the network.
- OTA firmware upgrades, also through a simple web interface. With this, your Wi-Fi module can always be ready for latest features and projects contributed by Parallax and the open source community.
- Supports HTTP (server), WebSocket (server), and TCP (client) connections. HTTP/WebSocket allows your Wi-Fi module to exchange data with other devices on the network through user-created web pages it serves. TCP enables connection to other devices for low-level communication, for example to build your own HTTP request to a page on the worldwide web.
- Power, Associate, Data In and Data Out LEDs visible from both sides of the pcb

Application Ideas

Set up your own pages for controlling and monitoring your robot or sensor projects. The module hosts and serves the pages over Wi-Fi and then acts as a simple serial intermediary between your microcontroller and HTTP or WebSocket clients accessing pages. Picture a Boe-Bot Robot reporting its Ping))) distance measurements and receiving control commands from a web page on a cell phone.'

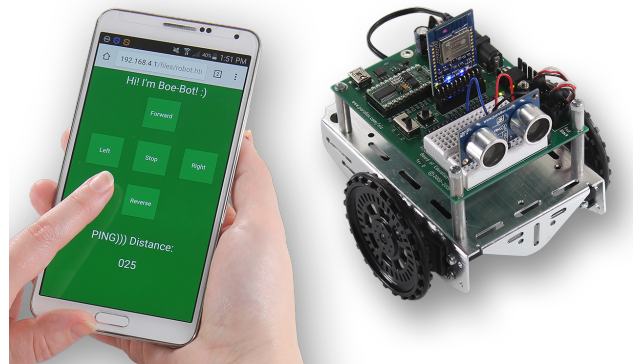

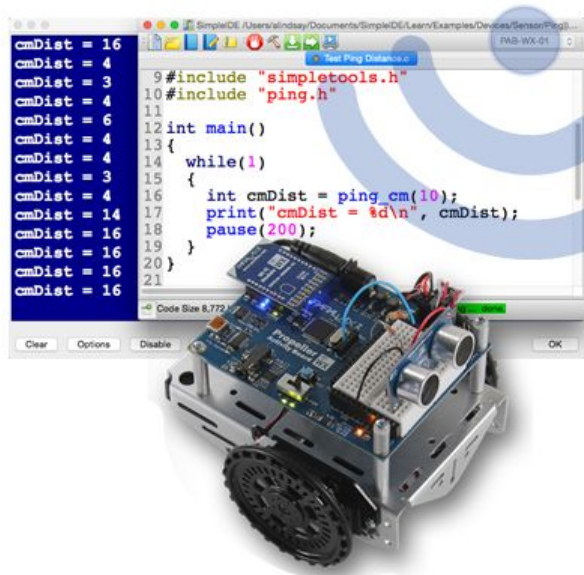

Program the Propeller Activity Board WX over Wi-Fi with the DIP module, and see its remote sensor data display on your computer in real time. This is especially useful when preparing for robot contests because your ActivityBot can roam in a maze and transmit sensor data to the SimpleIDE Terminal without the USB tether. Reprogram it without ever removing it from the maze!

Program your microcontroller to make TCP client connections with web pages on the Internet to get key pieces of information for your project. Send messages to pages hosted by services that can trigger emails, Twitter feeds, and more.

Specifications

- Wi-Fi Protocols: 802.11 b/g/n
- Network Protocols: IPv4, TCP/HTTP
- Security: WPA/WPA2
- Encryption: WEP/TKIP/AES
- Wi-Fi range: 30 meters LOS
- Voltage requirement options:
 - +3.3 to +5 VDC supplied through the breadboard connection
 - +3.3 VDC supplied through the WX (2 x 10 x 2 mm) connection
- Logic levels:
 - SIP - output high (set by Vin voltage, either 3.3 or 5.0 V), low 0 V. Input high >Vin/2, input low <Vin/2,
 - DIP - output high 3.3 V, low 0 V, input high > 1.5 V, input low < 1.5 V.
- Current requirements: Typical 75 mA, with Wi-Fi transmit peaks up to 360 mA
- Form factor:
 - SIP: 0.1" (2.54mm) spaced row of 10 right angle pins
 - DIP WX: 0.078" (2mm) spaced dual row of 10 straight pins
- PCB Dimensions: Approximately 1.0 x 1.5 in (26 x 37.5 mm)
- Operating temp range: +32 to +158 °F (0 to +70 °C)

Functional Description

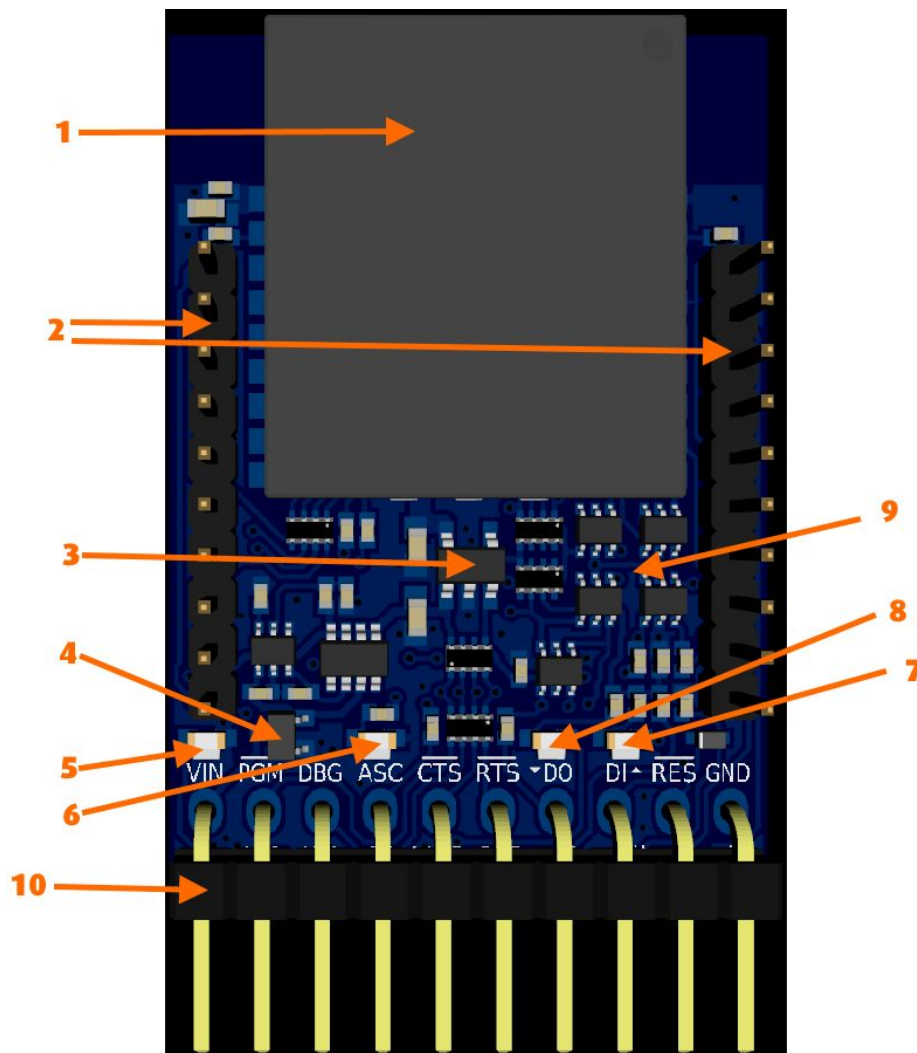

(1) ESP8266-WROOM-02 Wi-Fi Module

The ESP-WROOM-02 is a low-power 32-bit MCU Wi-Fi module based on an ESP8266 chip, embedded with TCP/IP network stacks, integrated with 16 Mbits of SPI flash, and capable of operating in low power connectivity modes such as DTIM10 at 1.2mW. ESP-WROOM-02 is FCC, CE, KCC, TELEC, LCIE and IC certified with the best FCC results for IoT modules in the industry.

(2) WX compatible headers

The DIP version plugs straight into the Propeller Activity Board WX 2 x 10 x 2mm socket.

(3) Linear 3.3V regulator

The linear 3.3V LDO regulator provides power to the ESP8266 microcontroller, and is used to set the logic level voltage at the WX IO ports.

(4) Reverse Polarity Protection

When the module is powered by the optional SIP (Breadboard) header, a P-Channel mosfet provides reverse polarity protection and almost zero voltage drop at VIN.

(5) Power LED

The power LED remains on whilst correct polarity voltage is supplied to either the WX/XBee socket, or the SIP (Breadboard) connector. LED's are visible from both sides of the board.

(6) ASC “Associate” LED

In the description, bold is the wireless mode, small text indicates connectivity or lack thereof, and after hyphen (-) indicates LED behavior and the timing.

- AP (has IP address) [Wirelessly accessible]* - ON constantly
- STA+AP (no IP on STA, IP on AP) [Wirelessly accessible]* - OFF 2000 ms, ON 2000 ms
- STA+AP (has IP on STA and AP) [Wirelessly accessible]* - OFF 2000 ms, ON 25 ms, OFF 150 ms, ON 2000 ms
- STA (has IP address) [Wirelessly accessible] - OFF 4000 ms, ON 25 ms
- STA (no IP address) [Not wirelessly accessible] - OFF constantly

(7) DI “Data-In” LED

The data-in LED will blink whilst serial data is being received by the module at either the WX header, or the SIP header. LED's are visible from both sides of the board.

(8) DO “Data-Out” LED

The data-out LED will blink whilst serial data is being transmitted by the module at either the WX header, or the SIP header. LED's are visible from both sides of the board.

(9) Level shifters and buffers

To ensure maximum compatibility with a wide range of 3.3V and 5V microcontrollers and development boards, the Parallax Wi-Fi module includes voltage level shifters and buffers to ensure that the logic voltage levels at the SIP header are set by the VIN voltage level. If you supply 3.3V to VIN, then the IO pins logic voltage level will be 3.3V. If you supply 5V to VIN, then the IO pins logic voltage level will be 5V.

(10) SIP “Breadboard” header

The right-angled SIP header is a standard 0.1” spaced male header, suitable for plugging directly into a breadboard, or will accept a wide range of header cables (eg. 800-00048, 751-00010). The four pins starting GND, RES, DI, DO are also compatible with the Parallax Prop Plug (#32201) for easy firmware re-programming and development.

Configuration Pages

The Parallax WX Wi-Fi module comes pre-configured as a wireless access point (AP mode). To join its network, find the access point that starts with wx- followed by 6 alphanumeric characters.



Later, if you have configured your Wi-Fi module to reside on another network, you can make it reappear as an access point by rapidly grounding and releasing the /PGM pin four times. If your Wi-Fi module is in an Activity Board WX, this can be done by pressing and releasing the RST button rapidly, four times. In a breadboard, a pushbutton with one terminal connected to GND and the other to /PGM is convenient.

After your device (computer, phone, or tablet) has joined the Wi-Fi module's network, you can go to its Configuration home page by navigating to <http://192.168.4.1>.

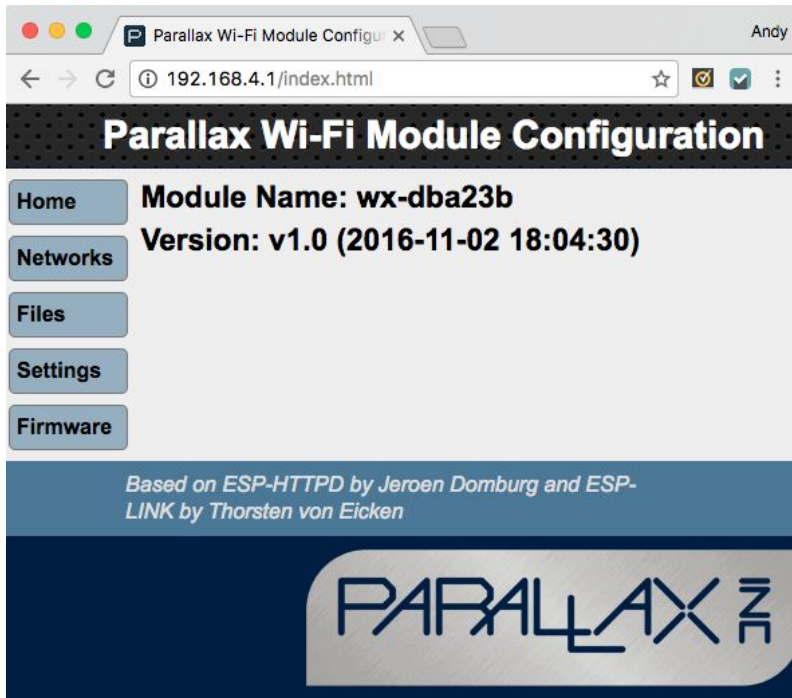

The Configuration home page has 4 sub-pages (try Chrome if your browser doesn't support all of the features listed)

- Networks: For setting the network mode and joining another network.
- Files: For uploading web pages and other files for interacting with microcontroller/electronic/robotic applications. The pages can be accessed later through a computer or portable device.
- Settings: For defining the the module's name and serial communication settings for data exchange with the host microcontroller.
- Firmware: For updating the firmware with newer releases that will be made available through the Wi-Fi module product page at www.parallax.com.

To make the Wi-Fi module join another network, click the networks tab. Then, set the Wi-Fi mode to STA+AP. A network list should appear after a brief wait. To join the network, click the radio button next to the network, enter a password (if needed) and then click the Connect button.

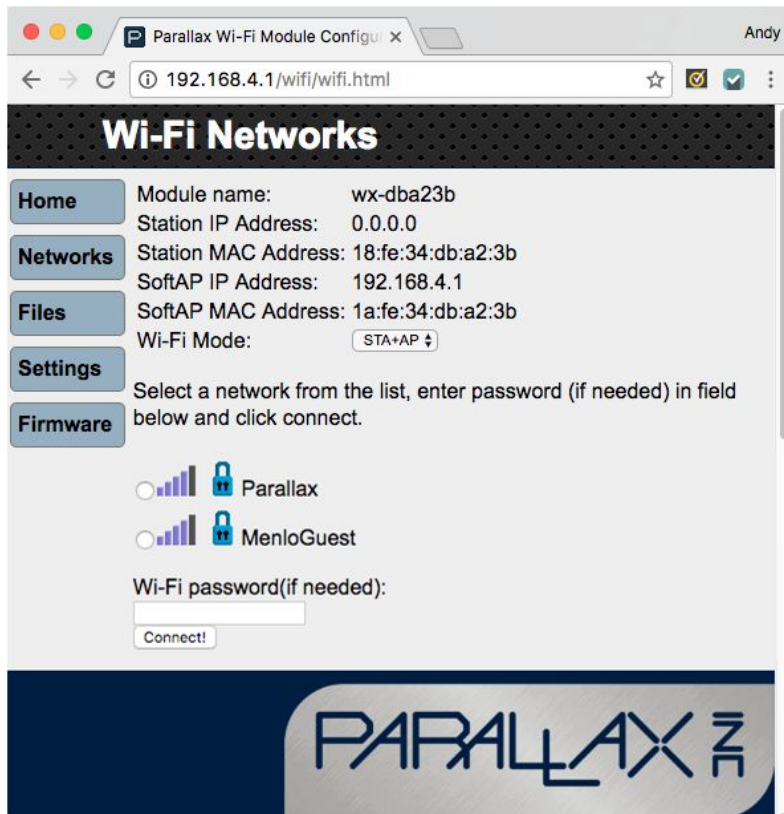

1. **IMMEDIATELY** make a note of the IP address the network assigned to your module.
2. **IMMEDIATELY GO BACK TO THE NETWORKS PAGE AND SET THE Wi-Fi MODE TO STA.** Leaving it in STA+AP mode could introduce a security vulnerability to the network the Wi-Fi module joins. In this example, it's 10.10.11.145, and in station mode, that should be used in place of 192.168.4.1, which works in AP mode.

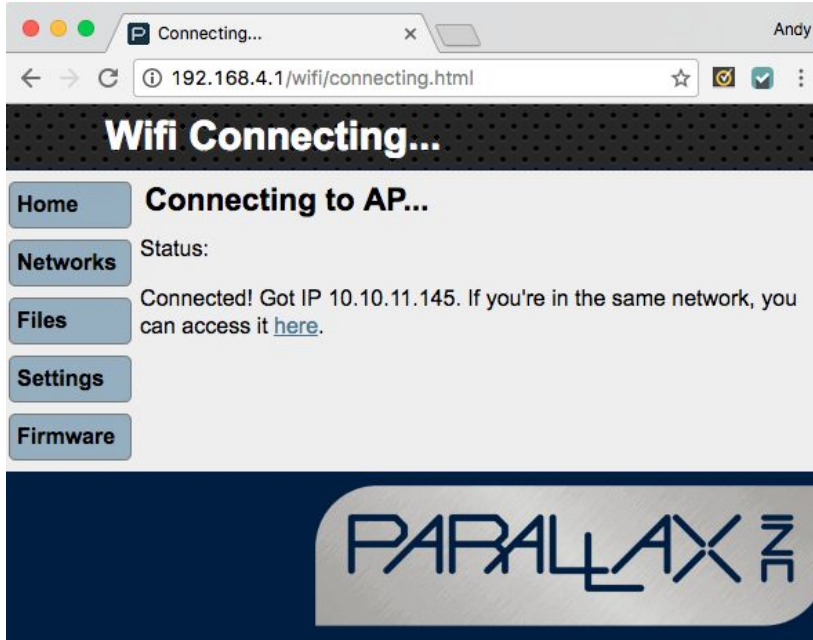

The Files page makes it easy to upload custom web pages and other files that the wi-Fi module can serve. Just click the Choose File button, browse to the file you want to upload, and then double-click it. Tutorials for writing web pages that interact with your microcontroller through the Wi-Fi module are available, and example files are in a subfolder of the firmware zip file, both of which are available from the 32420S and 32420D product pages from www.parallax.com/.

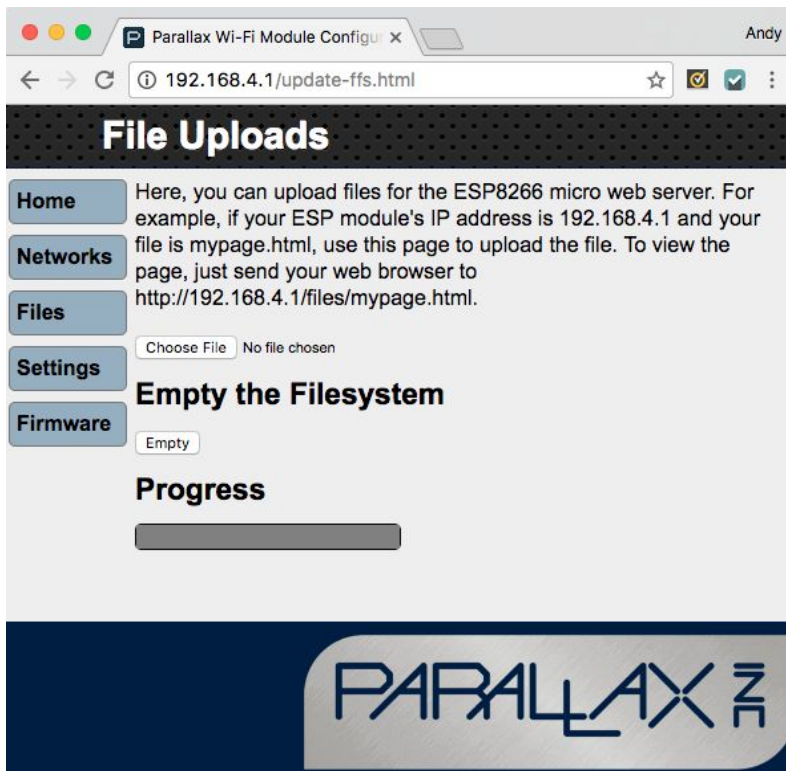

Assuming the file you uploaded is named web-page.html, you'll be able to access it at <http://192.168.4.1/files/web-page.html> in AP mode, or <http://TheIPAddressYouNoted/files/web-page.html> in STA mode.

It's fine to repeatedly change a file and re-upload it. The system will always serve the most recently uploaded version of a file if more than one version has been uploaded. There is almost 1 MB of file storage. The first version of this firmware does not feature a full file manager, but with 1 MB of storage and the ability to repeatedly upload any modifications to a file, even under the same name will support most prototyping endeavors. The Empty can also be used to clear the file system, and then files can be re-uploaded.

The Settings page has a module name field, which can be used to give the module a custom and more recognizable name. The other settings pertain to serial communication and will vary by microcontroller host, and in some cases by application as well. The default settings are recommended for use with the Propeller Microcontroller in the Propeller Activity Board. These settings make it possible to also load programs from a computer into a Propeller in an Activity Board WX through the Wi-Fi module. Settings for the BASIC Stamp 2 are listed in the Getting Started Guide for that microcontroller, linked under the Additional Resources tab on the 32420S product page at www.parallax.com.

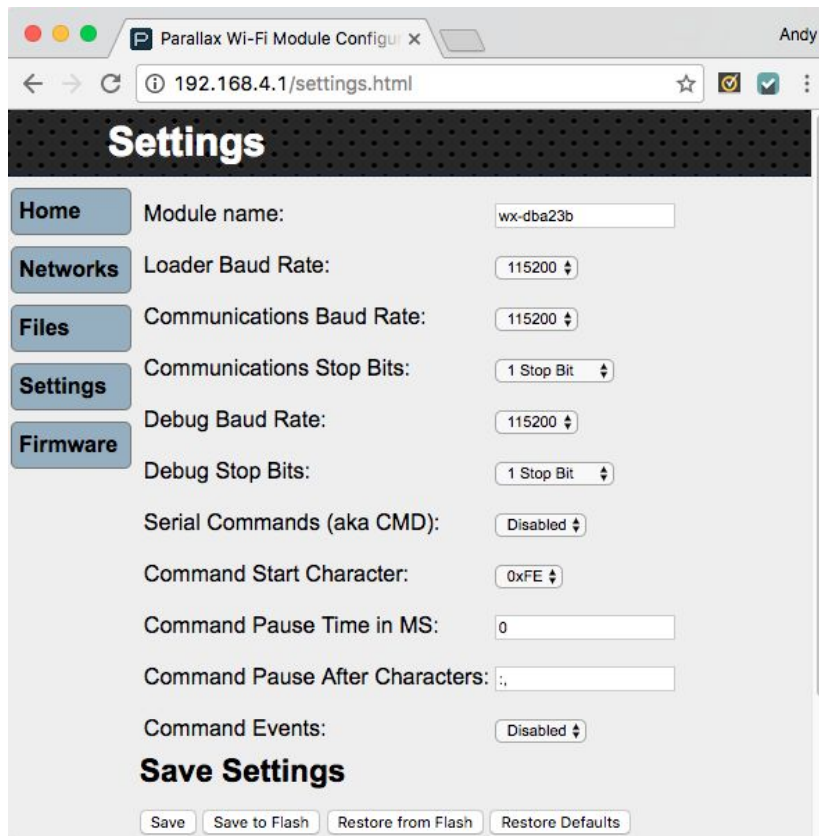

The Parallax Wi-Fi module is designed to support over the air (OTA) firmware upgrades. So let's say you purchased the Wi-Fi module, and some time later, the firmware gets upgraded by Parallax or its community to support more cool applications. If you want your Wi-Fi module to support those applications too, all you have to do is download the firmware from the Parallax web site, unzip it, and then use this page to choose the file (with a .ota extension) and load it into the Wi-Fi module.

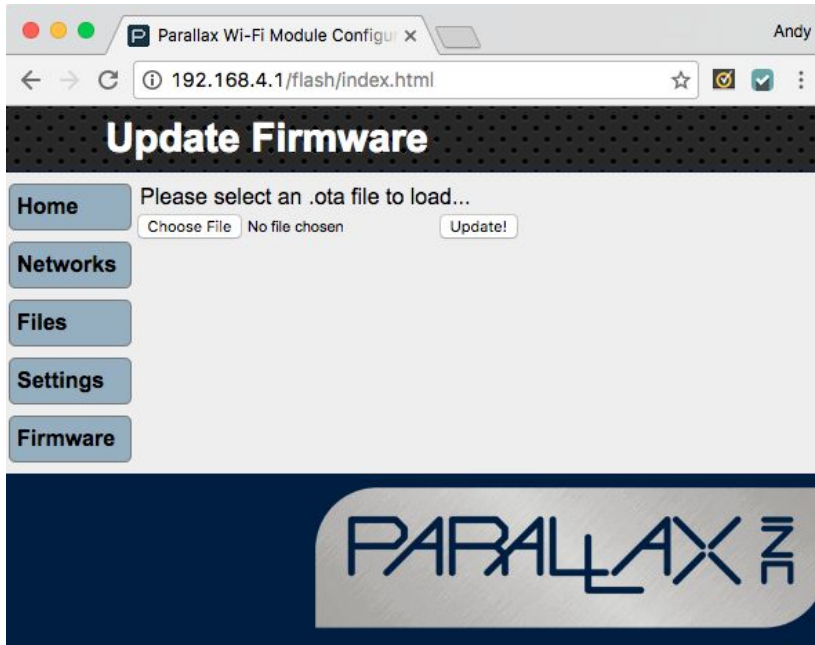

Pin Map

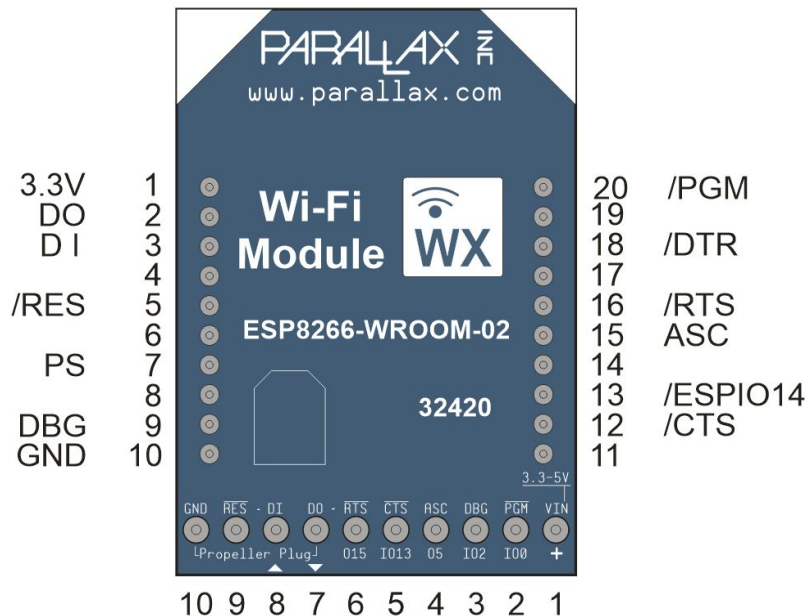

Pin Descriptions

Module Pin	Direction	SIP Pin	DIP Pin	ESP 8266	Function
VIN	Power input	1	1		(SIP) 3.3 V or 5 V power input (DIP) 3.3 V power input
/PGM	Input	2	20	IO0	If held low during power up, ESP8266 boots into a mode ready for serial firmware load. Can also be pulled low rapidly, 4 times in a row to put Wi-Fi module into AP+STA mode.
DBG	Output	3	9	IO2	Transmits information about exchanges with the host microcontroller.
ASC	Output	4	15	IO5	Associate - high/low patterns indicating Wi-Fi mode and connection
/CTS	Input / Output	5	12	IO13	User configurable pin
/RTS	Output	6	16	IO15	User configurable pin
DO	Output	7	2	TXD	Transmits serial data to microcontroller host
DI	Input	8	3	RXD	Receives serial data from microcontroller host
/RES	Input	9	5	EN	Active-low reset line
GND	Power input	10	10	GND	Ground
PS	Output		7	IO4	May be used in the future to remotely switch a WX carrier board's programming source from USB to Wi-Fi
DTR	Output		18	IO12	Toggle's microcontroller reset line in WX carrier board

PCB Dimensions

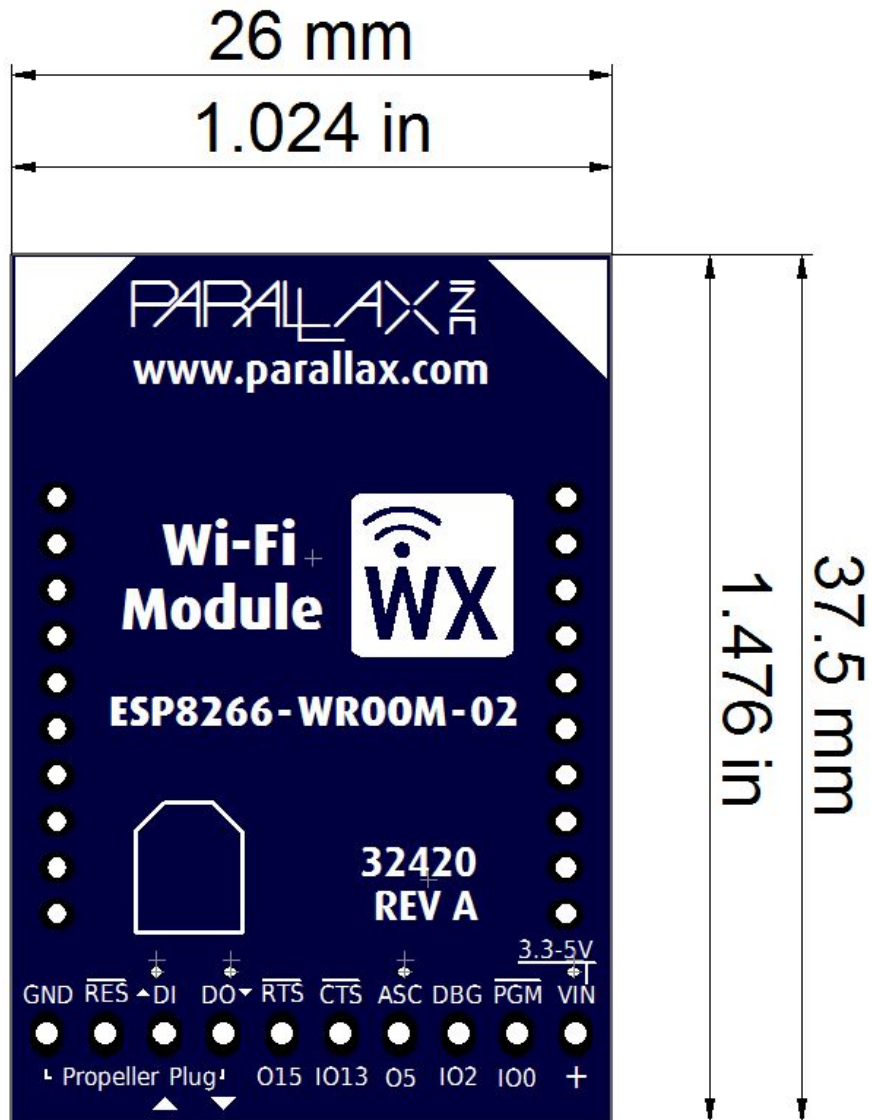

Revision History

Version 1.0: Original release

Компания «Океан Электроники» предлагает заключение долгосрочных отношений при поставках импортных электронных компонентов на взаимовыгодных условиях!

Наши преимущества:

- Поставка оригинальных импортных электронных компонентов напрямую с производств Америки, Европы и Азии, а так же с крупнейших складов мира;
- Широкая линейка поставок активных и пассивных импортных электронных компонентов (более 30 млн. наименований);
- Поставка сложных, дефицитных, либо снятых с производства позиций;
- Оперативные сроки поставки под заказ (от 5 рабочих дней);
- Экспресс доставка в любую точку России;
- Помощь Конструкторского Отдела и консультации квалифицированных инженеров;
- Техническая поддержка проекта, помощь в подборе аналогов, поставка прототипов;
- Поставка электронных компонентов под контролем ВП;
- Система менеджмента качества сертифицирована по Международному стандарту ISO 9001;
- При необходимости вся продукция военного и аэрокосмического назначения проходит испытания и сертификацию в лаборатории (по согласованию с заказчиком);
- Поставка специализированных компонентов военного и аэрокосмического уровня качества (Xilinx, Altera, Analog Devices, Intersil, Interpoint, Microsemi, Actel, Aeroflex, Peregrine, VPT, Syfer, Eurofarad, Texas Instruments, MS Kennedy, Miteq, Cobham, E2V, MA-COM, Hittite, Mini-Circuits, General Dynamics и др.);

Компания «Океан Электроники» является официальным дистрибьютором и эксклюзивным представителем в России одного из крупнейших производителей разъемов военного и аэрокосмического назначения «JONHON», а так же официальным дистрибьютором и эксклюзивным представителем в России производителя высокотехнологичных и надежных решений для передачи СВЧ сигналов «FORSTAR».



JONHON

«JONHON» (основан в 1970 г.)

Разъемы специального, военного и аэрокосмического назначения:

(Применяются в военной, авиационной, аэрокосмической, морской, железнодорожной, горно- и нефтедобывающей отраслях промышленности)

«FORSTAR» (основан в 1998 г.)

ВЧ соединители, коаксиальные кабели,
кабельные сборки и микроволновые компоненты:

(Применяются в телекоммуникациях гражданского и специального назначения, в средствах связи, РЛС, а так же военной, авиационной и аэрокосмической отраслях промышленности).



Телефон: 8 (812) 309-75-97 (многоканальный)

Факс: 8 (812) 320-03-32

Электронная почта: ocean@oceanchips.ru

Web: <http://oceanchips.ru/>

Адрес: 198099, г. Санкт-Петербург, ул. Калинина, д. 2, корп. 4, лит. А