

CMOS LDO Regulators for Portable Equipments

1ch 300mA CMOS LDO Regulators



BHxxM0A series

● **General Description**

BHxxM0A series are high-performance CMOS LDO regulators with output current ability of up to 300mA. These devices have excellent noise characteristics despite of their low circuit current consumption of 65µA. They are most appropriate for various applications such as power supplies for logic IC, RF, and camera modules.

● **Features**

- High Output Voltage Accuracy: ±1 % (±25mV on VOUT<2.5V products)
- Dropout voltage: 60mV (IOUT=100mA)
- Compatible with small ceramic capacitor
- Output Voltage ON/OFF Control
- Built-in Over Current Protection Circuit (OCP)
- Built-in Thermal Shutdown Circuit (TSD)
- Ultra-small power package:HVSOF6

● **Applications**

- Battery-driven portable devices
- Other electronic devices using microcontrollers or logic circuits

● **Key Specifications**

- Input Power Supply Voltage Range: 2.5V to 5.5V
- Output Current Range: 0 to 300mA
- Operating Temperature Range: -40 to 85°C
- Output Voltage Lineup: 1.5V to 3.4V
- Output Voltage Accuracy: ±1%
- Circuit Current: 65µA (Typ.)
- Standby Current: 0µA (Typ.)

● **Package**

HVSOF6

W(Typ.) x D(Typ.) x H(Max.)
1.60mm x 3.00mm x 0.75mm



● **Typical Application Circuit**

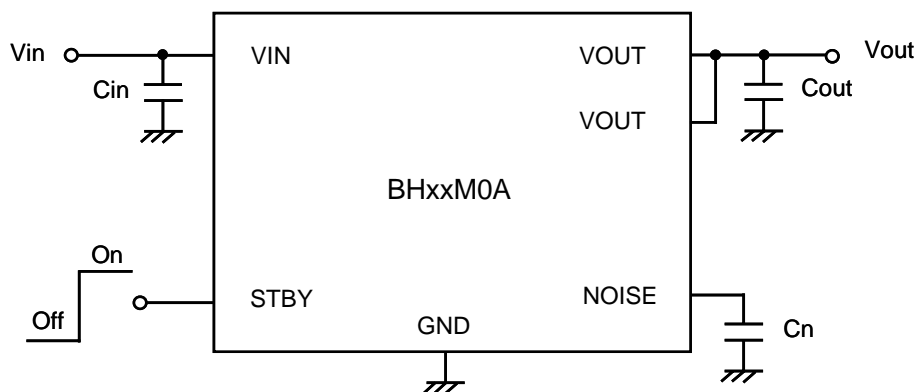

Figure 1. Typical Application Circuit

●Pin Configuration



●Pin Description

Pin No.	Symbol	Function
1	VIN	INPUT Pin
2	VOUT	OUTPUT Pin
3	VOUT	OUTPUT Pin
4	NOISE	NOISE reducing capacitor ground terminal
5	GND	GROUND Pin
6	STBY	OUTPUT CONTROL Pin (High:ON,Low:OFF)
reverse	FIN	OPEN

●Block Diagram

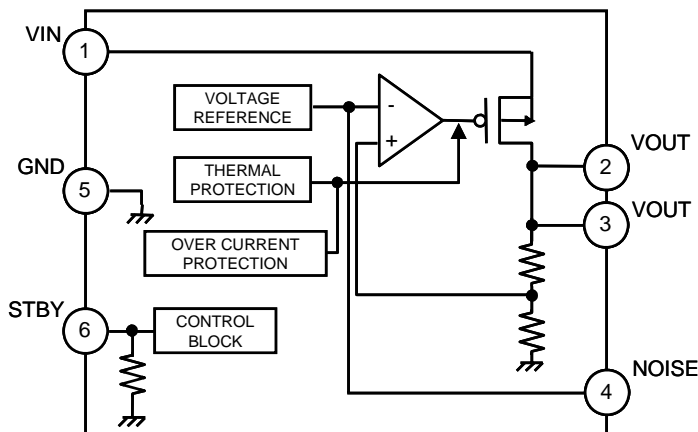

Figure 2. Block diagram

● Absolute Maximum Ratings

Parameter	Symbol	Ratings	Unit
Maximum Power Supply Voltage Range	V _{MAX}	-0.3 to +6.5	V
Power Dissipation	P _d	680 ^(*)	mW
Maximum Junction Temperature	T _{jmax}	+125	°C
Operating Temperature Range	T _{opr}	-40 to +85	°C
Storage Temperature Range	T _{stg}	-55 to +125	°C

(*) Derate by 6.8mW/°C when operating above Ta=25°C. (When mounted on a board 70mm × 70mm × 1.6mm glass-epoxy board, two layer.)

● Recommended Operating Ratings

Parameter	Symbol	Limit	Unit
Input Power Supply Voltage Range	V _{IN}	2.5 to 5.5	V
Maximum Output Current Range	I _{MAX}	0 to 300	mA

● Recommended Operating Conditions

Parameter	Symbol	Ratings			Unit	Conditions
		Min.	Typ.	Max.		
Input Capacitor	C _{in}	1.0 ^(*)	—	—	μF	A ceramic capacitor is recommended.
Output Capacitor	C _{out}	1.0 ^(*)	—	—	μF	A ceramic capacitor is recommended.
Noise Decrease Capacitor	C _n	—	0.01	0.22	μF	A ceramic capacitor is recommended.

(*) Set the value of the capacitor so that it does not fall below the minimum value. Take into considerations the temperature characteristics, DC device characteristics, and degradation with time.

●Electrical characteristics

(Unless otherwise noted, Ta=25°C, VIN=VOUT+1.0V^(*), STBY=1.5V, Cin=1μF, Co=1μF, Cn=0.01μF.)

PARAMETER	Symbol	Limit			UNIT	Conditions
		MIN.	TYP.	MAX.		
【REG】						
Output Voltage	VOUT	VOUT x0.99	VOUT	VOUT x1.01	V	IOUT=1mA, VOUT ≥ 2.5V
		VOUT -25mV	VOUT	VOUT +25mV		IOUT=1mA, VOUT < 2.5V
Circuit Current	IGND	-	65	95	μA	IOUT=1mA
Circuit Current (STBY)	ISTBY	-	-	1.0	μA	STBY=0V
Ripple Rejection Ratio	R.R.	-	60	-	dB	VRR=-20dBv, fRR=1kHz, IOUT=10mA
Dropout Voltage	VSAT1	-	60	90	mV	VIN=0.98xVOUT, IOUT=100mA VOUT ≥ 2.5V
Line Regulation	VDL1	-	2	20	mV	IOUT=1mA VIN=VOUT+0.5V to 5.5V ^(*)
Load Regulation 1	VDLO1	-	6	30	mV	IOUT=1mA to 100mA
Load Regulation 2	VDLO2	-	18	90	mV	IOUT=1mA to 300mA
Output Voltage Temperature	ΔVOUT/ΔTa	-	±100	-	ppm/°C	IOUT=1mA, Ta=-40 to +85°C
【OCP】						
Limit Current	ILMAX	-	600	-	mA	Vo=VOUTx0.85
Short Current	ISHORT	-	100	-	mA	Vo=0V
【STBY】						
STBY Pull-down Resistor	RSTB	550	1100	2200	kΩ	
STBY Control Voltage	ON	VSTBH	1.5	-	VCC	V
	OFF	VSTBL	-0.3	-	0.3	V

(*) VIN=3.5V for VOUT < 2.5V.

(*) VIN=3.0V to 5.5V for VOUT < 2.5V.

●Reference data BH30M0AWHFV (Unless otherwise specified, Ta=25°C.)

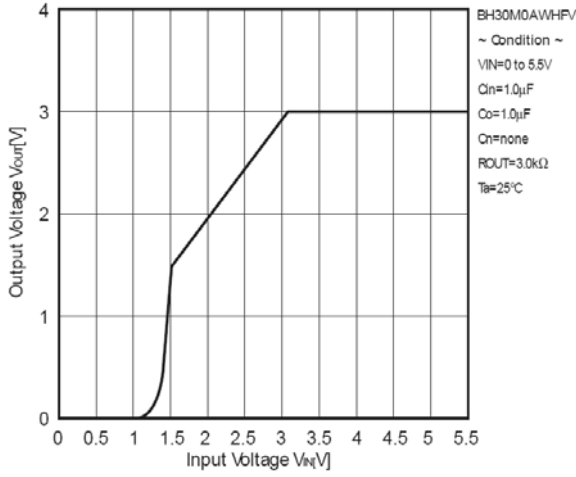

Figure 3. Output Voltage vs. Input Voltage

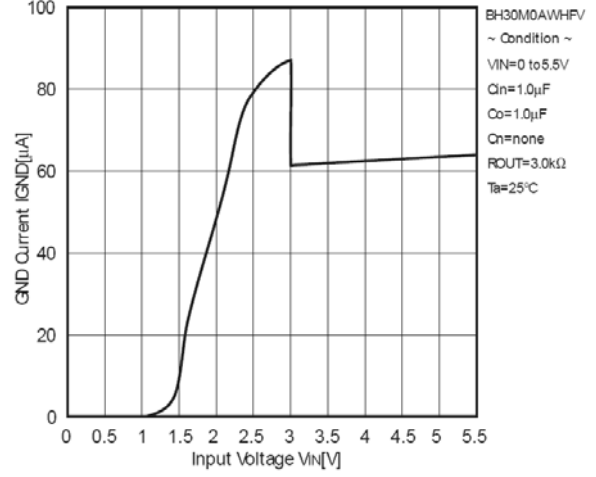

Figure 4. GND Current vs. Input Voltage

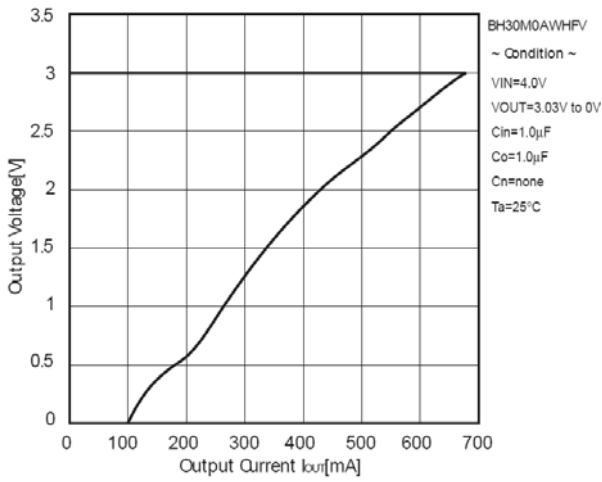

Figure 5. Output Voltage vs. Output Current (OCP Threshold)

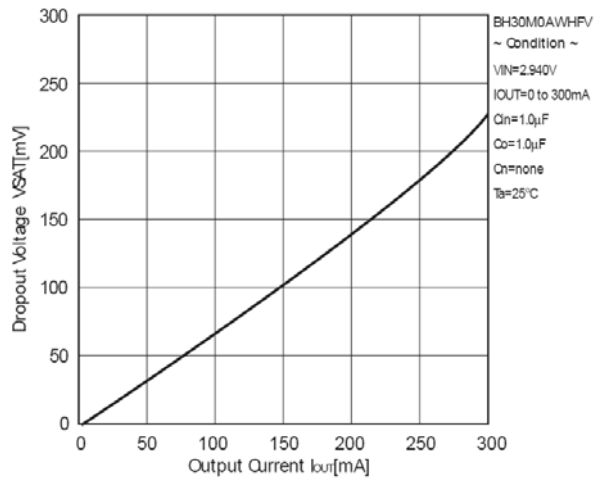

Figure 6. Dropout Voltage vs. Output Current

●Reference data BH30M0AWHFV (Ta=25°C, unless otherwise specified.)

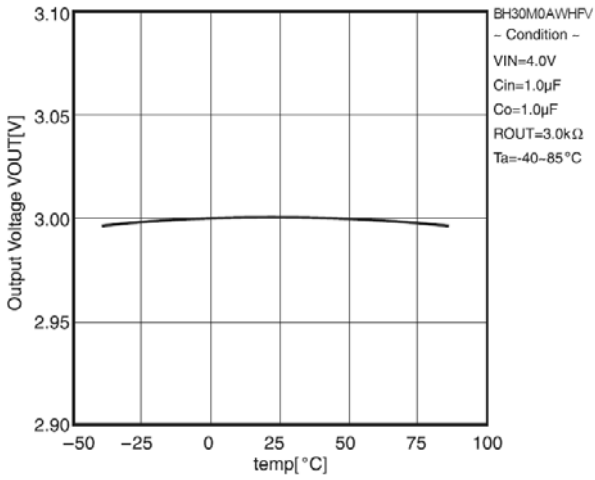

Figure 7. Output Voltage vs. Temperature

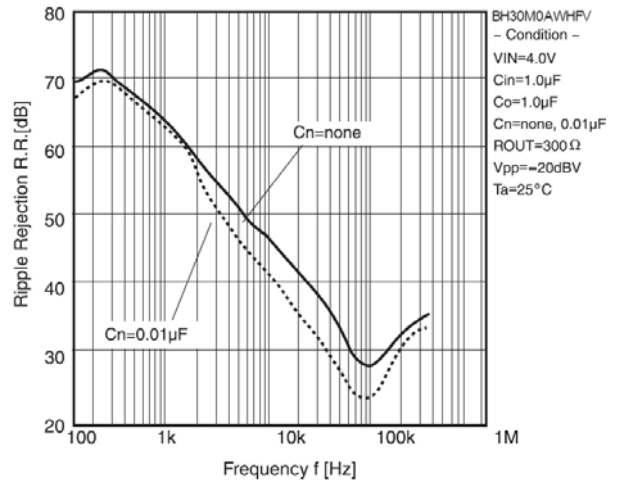

Figure 8. Ripple Rejection vs. Frequency

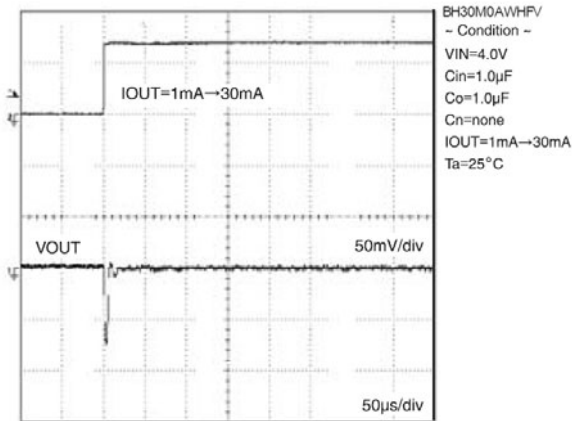
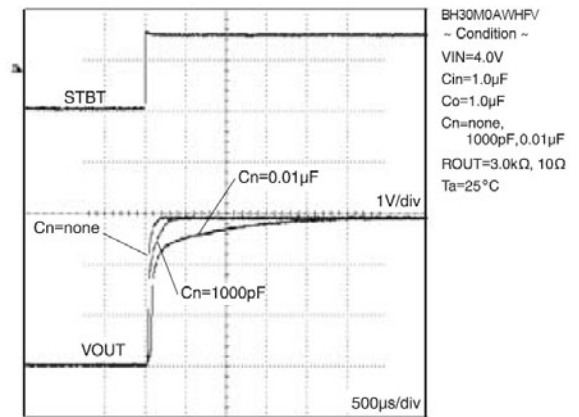

Figure 9. Load response



IOUT=300mA (ROUT=10Ω)

Figure 10. Startup time

●About input/output capacitor

It is recommended that an input capacitor is placed near pins between the VCC pin and GND as well as an output capacitor between the output pin and GND. The input is valid when the power supply impedance is high or when the PCB trace has significant length. For the output capacitor, the greater the capacitance, the more stable the output will be depending on the load and line voltage variations. However, please check the actual functionality of this capacitor by mounting it on a board for the actual application. Ceramic capacitors usually have different, thermal and equivalent series resistance characteristics, and may degrade gradually over continued use.

For additional details, please check with the manufacturer, and select the best ceramic capacitor for your application



Figure 11. Capacity-bias characteristics

●Equivalent Series Resistance (ESR) of a Ceramic Capacitor

Capacitors generally have ESR (equivalent series resistance) and it operates stably in the ESR-IOUT area shown on the right. Since ceramic capacitors, tantalum capacitors, electrolytic capacitors, etc. generally have different ESR, please check the ESR of the capacitor to be used and use it within the stability area range shown in the right graph for evaluation of the actual application.



Figure 12. Stable region (example)

●Power Dissipation (Pd)

As for power dissipation, an estimate of heat reduction characteristics and internal power consumption of IC are shown, so please use these for reference. Since power dissipation changes substantially depending on the implementation conditions (board size, board thickness, metal wiring rate, number of layers and through holes, etc.), it is recommended to measure Pd on a set board. Exceeding the power dissipation of IC may lead to deterioration of the original IC performance, such as causing the operation of the thermal shutdown circuit or reduction in current capability. Therefore, be sure to prepare sufficient margin within power dissipation for usage.

Calculation of the maximum internal power consumption of IC (P_{MAX})

$P_{MAX}=(V_{IN}-V_{OUT})\times I_{OMAX}$ Where : V_{IN} =Input voltage V_{OUT} = Output voltage I_{OMAX} : Maximum output current

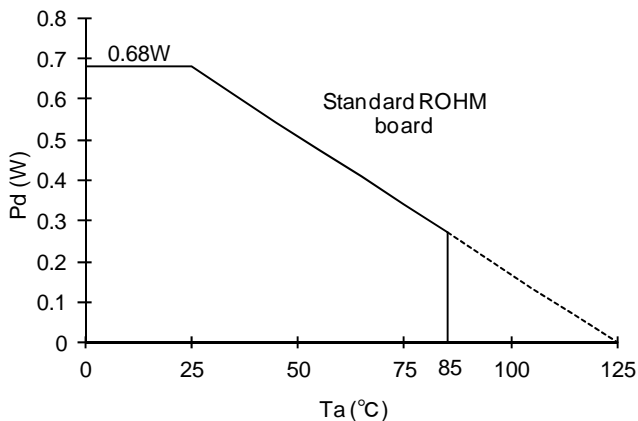

* Please design the margin so that P_{MAX} becomes is than Pd (P_{MAX}<Pd) within the usage temperature range

Figure 13.HVSO6 Power dissipation heat reduction characteristics (Reference)

●Operational Notes

- 1) Absolute maximum ratings
This product is produced with strict quality control, however it may be destroyed if operated beyond its absolute maximum ratings. In addition, it is impossible to predict all destructive situations such as short-circuit modes, open circuit modes, etc. Therefore, it is important to consider circuit protection measures, like adding a fuse, in case the IC is operated in a special mode exceeding the absolute maximum ratings.
- 2) GND Potential
GND potential must be the lowest potential of all pins of the IC at all operating conditions. Ensure that no pins are at a voltage below the ground pin at any time, even during transient condition.
- 3) Setting of Heat
Carry out the heat design that have adequate margin considering Pd of actual working states.
- 4) Pin Short and Mistake Fitting
When mounting the IC on the PCB, pay attention to the orientation of the IC. If there is mistake in the placement, the IC may be burned up.
- 5) Actions in Strong Magnetic Field
Using the IC within a strong magnetic field may cause the IC to malfunction.
- 6) Mutual impedance
Use short and wide wiring tracks for the power supply and ground to keep the mutual impedance as small as possible. Use a capacitor to keep ripple to a minimum.
- 7) STBY Pin Voltage
For standby mode, set STBY voltage below 0.3V. For normal operation, set the pin voltage beyond 1.5V. It is not recommended to set STBY voltage between 0.3V and 1.5V, as it may cause malfunctions.
- 8) Over Current Protection Circuit
Over current and short circuit protection is built-in at the output, and IC destruction is prevented at the time of load short circuit. These protection circuits are effective in the destructive prevention by the sudden accident. Please avoid applications where the over current protection circuit operates continuously.
- 9) Thermal shutdown
This IC also features a thermal shutdown circuit that is designed to turn off the output when the junction temperature of the IC exceeds about 170°C. This feature is intended to protect the IC only in the event of thermal overload and is not designed to guarantee operation or act as an active security device for applications. Therefore, it is not recommended that you design application where TSD will work in normal condition.

	TSD ON TEMPURATURE(°C) (typ.)	HYSTERESIS TEMPURATURE(°C) (typ.)
BHxxM0A series	170	15
- 10) Noise Pin
NOISE pin can drive small current, since it is directly connected to reference voltage circuit. The output voltage may drop when the load of NOISE pin is more than 100nA. If the pin is connected to a capacitor, please use ceramic capacitor for small leak current. Please take note that the output noise is smaller as NOISE pin capacitor is larger, but startup time is longer.
- 11) Output capacitor
To prevent oscillation at output, it is recommended that the IC be operated at the stable region shown in Figure 12. It operates at the capacitance value of more than 1.0μF. As capacitance is larger, stability becomes more stable and characteristic of output load fluctuation is also improved.

●Ordering Information

<div style="display: flex; justify-content: space-around; border: 1px solid black; padding: 5px;"> B H x x M 0 A W H F V - T R </div>					
ROHM Part No.	Output voltage xx=15:1.5V 18:1.8V 20:2.0V 21:2.1V 25:2.5V 26:2.6V 27:2.7V 28:2.8V 29:2.9V 30:3.0V 31:3.1V 32:3.2V 33:3.3V 34:3.4V	Series name M0A:300mA	Shutdown switch W:With switch	Package HFV:HVSOF6	Packaging and forming specifications TR:Embossed tape and reel

●Physical Dimension Tape and Reel Information

HVSOF6

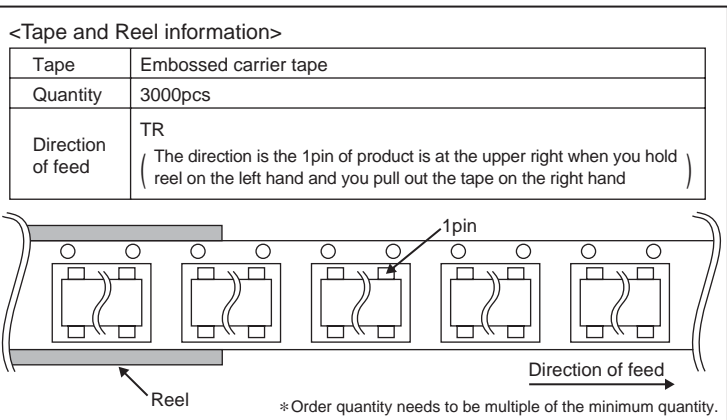
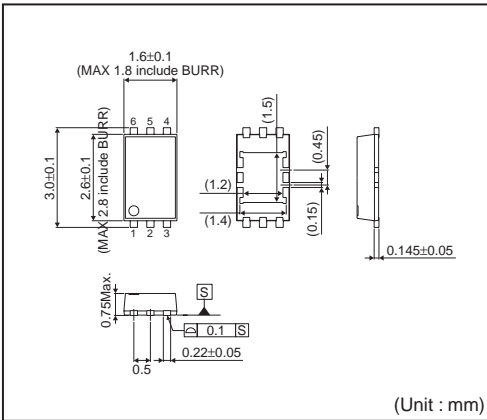

●Marking Diagram(s)

xx	Output Voltage	Marking
15	1.5V typ.	EA
18	1.8V typ.	EB
20	2.0V typ.	EC
21	2.1V typ.	ED
25	2.5V typ.	EE
26	2.6V typ.	EF
27	2.7V typ.	EG
28	2.8V typ.	EH
29	2.9V typ.	EJ
30	3.0V typ.	EK
31	3.1V typ.	EL
32	3.2V typ.	EM
33	3.3V typ.	EN
34	3.4V typ.	EP

HVSOF6(TOP VIEW)

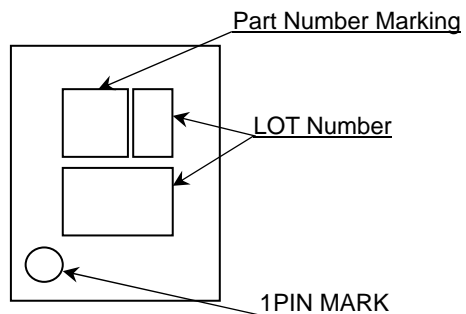

●Revision History

Date	Revision	Changes
04.Apr.2013	001	New Release

Notice

●General Precaution

- 1) Before you use our Products, you are requested to carefully read this document and fully understand its contents. ROHM shall not be in any way responsible or liable for failure, malfunction or accident arising from the use of any ROHM's Products against warning, caution or note contained in this document.
- 2) All information contained in this document is current as of the issuing date and subject to change without any prior notice. Before purchasing or using ROHM's Products, please confirm the latest information with a ROHM sales representative.

●Precaution on using ROHM Products

- 1) Our Products are designed and manufactured for application in ordinary electronic equipments (such as AV equipment, OA equipment, telecommunication equipment, home electronic appliances, amusement equipment, etc.). If you intend to use our Products in devices requiring extremely high reliability (such as medical equipment, transport equipment, traffic equipment, aircraft/spacecraft, nuclear power controllers, fuel controllers, car equipment including car accessories, safety devices, etc.) and whose malfunction or failure may cause loss of human life, bodily injury or serious damage to property ("Specific Applications"), please consult with the ROHM sales representative in advance. Unless otherwise agreed in writing by ROHM in advance, ROHM shall not be in any way responsible or liable for any damages, expenses or losses incurred by you or third parties arising from the use of any ROHM's Products for Specific Applications.
- 2) ROHM designs and manufactures its Products subject to strict quality control system. However, semiconductor products can fail or malfunction at a certain rate. Please be sure to implement, at your own responsibilities, adequate safety measures including but not limited to fail-safe design against the physical injury, damage to any property, which a failure or malfunction of our Products may cause. The following are examples of safety measures:
 - [a] Installation of protection circuits or other protective devices to improve system safety
 - [b] Installation of redundant circuits to reduce the impact of single or multiple circuit failure
- 3) Our Products are designed and manufactured for use under standard conditions and not under any special or extraordinary environments or conditions, as exemplified below. Accordingly, ROHM shall not be in any way responsible or liable for any damages, expenses or losses arising from the use of any ROHM's Products under any special or extraordinary environments or conditions. If you intend to use our Products under any special or extraordinary environments or conditions (as exemplified below), your independent verification and confirmation of product performance, reliability, etc. prior to use, must be necessary:
 - [a] Use of our Products in any types of liquid, including water, oils, chemicals, and organic solvents
 - [b] Use of our Products outdoors or in places where the Products are exposed to direct sunlight or dust
 - [c] Use of our Products in places where the Products are exposed to sea wind or corrosive gases, including Cl₂, H₂S, NH₃, SO₂, and NO₂
 - [d] Use of our Products in places where the Products are exposed to static electricity or electromagnetic waves
 - [e] Use of our Products in proximity to heat-producing components, plastic cords, or other flammable items
 - [f] Sealing or coating our Products with resin or other coating materials
 - [g] Use of our Products without cleaning residue of flux (even if you use no-clean type fluxes, cleaning residue of flux is recommended); or Washing our Products by using water or water-soluble cleaning agents for cleaning residue after soldering
 - [h] Use of the Products in places subject to dew condensation
- 4) The Products are not subject to radiation-proof design.
- 5) Please verify and confirm characteristics of the final or mounted products in using the Products.
- 6) In particular, if a transient load (a large amount of load applied in a short period of time, such as pulse) is applied, confirmation of performance characteristics after on-board mounting is strongly recommended. Avoid applying power exceeding normal rated power; exceeding the power rating under steady-state loading condition may negatively affect product performance and reliability.
- 7) De-rate Power Dissipation (Pd) depending on Ambient temperature (Ta). When used in sealed area, confirm the actual ambient temperature.
- 8) Confirm that operation temperature is within the specified range described in the product specification.
- 9) ROHM shall not be in any way responsible or liable for failure induced under deviant condition from what is defined in this document.

●Precaution for Mounting / Circuit board design

- 1) When a highly active halogenous (chlorine, bromine, etc.) flux is used, the residue of flux may negatively affect product performance and reliability.
- 2) In principle, the reflow soldering method must be used; if flow soldering method is preferred, please consult with the ROHM representative in advance.

For details, please refer to ROHM Mounting specification

●Precautions Regarding Application Examples and External Circuits

- 1) If change is made to the constant of an external circuit, please allow a sufficient margin considering variations of the characteristics of the Products and external components, including transient characteristics, as well as static characteristics.
- 2) You agree that application notes, reference designs, and associated data and information contained in this document are presented only as guidance for Products use. Therefore, in case you use such information, you are solely responsible for it and you must exercise your own independent verification and judgment in the use of such information contained in this document. ROHM shall not be in any way responsible or liable for any damages, expenses or losses incurred by you or third parties arising from the use of such information.

●Precaution for Electrostatic

This Product is electrostatic sensitive product, which may be damaged due to electrostatic discharge. Please take proper caution in your manufacturing process and storage so that voltage exceeding the Products maximum rating will not be applied to Products. Please take special care under dry condition (e.g. Grounding of human body / equipment / solder iron, isolation from charged objects, setting of Ionizer, friction prevention and temperature / humidity control).

●Precaution for Storage / Transportation

- 1) Product performance and soldered connections may deteriorate if the Products are stored in the places where:
 - [a] the Products are exposed to sea winds or corrosive gases, including Cl₂, H₂S, NH₃, SO₂, and NO₂
 - [b] the temperature or humidity exceeds those recommended by ROHM
 - [c] the Products are exposed to direct sunshine or condensation
 - [d] the Products are exposed to high Electrostatic
- 2) Even under ROHM recommended storage condition, solderability of products out of recommended storage time period may be degraded. It is strongly recommended to confirm solderability before using Products of which storage time is exceeding the recommended storage time period.
- 3) Store / transport cartons in the correct direction, which is indicated on a carton with a symbol. Otherwise bent leads may occur due to excessive stress applied when dropping of a carton.
- 4) Use Products within the specified time after opening a humidity barrier bag. Baking is required before using Products of which storage time is exceeding the recommended storage time period.

●Precaution for Product Label

QR code printed on ROHM Products label is for ROHM's internal use only.

●Precaution for Disposition

When disposing Products please dispose them properly using an authorized industry waste company.

●Precaution for Foreign Exchange and Foreign Trade act

Since our Products might fall under controlled goods prescribed by the applicable foreign exchange and foreign trade act, please consult with ROHM representative in case of export.

●Precaution Regarding Intellectual Property Rights

- 1) All information and data including but not limited to application example contained in this document is for reference only. ROHM does not warrant that foregoing information or data will not infringe any intellectual property rights or any other rights of any third party regarding such information or data. ROHM shall not be in any way responsible or liable for infringement of any intellectual property rights or other damages arising from use of such information or data.:
- 2) No license, expressly or implied, is granted hereby under any intellectual property rights or other rights of ROHM or any third parties with respect to the information contained in this document.

● **Other Precaution**

- 1) The information contained in this document is provided on an "as is" basis and ROHM does not warrant that all information contained in this document is accurate and/or error-free. ROHM shall not be in any way responsible or liable for any damages, expenses or losses incurred by you or third parties resulting from inaccuracy or errors of or concerning such information.
- 2) This document may not be reprinted or reproduced, in whole or in part, without prior written consent of ROHM.
- 3) The Products may not be disassembled, converted, modified, reproduced or otherwise changed without prior written consent of ROHM.
- 4) In no event shall you use in any way whatsoever the Products and the related technical information contained in the Products or this document for any military purposes, including but not limited to, the development of mass-destruction weapons.
- 5) The proper names of companies or products described in this document are trademarks or registered trademarks of ROHM, its affiliated companies or third parties.

Компания «Океан Электроники» предлагает заключение долгосрочных отношений при поставках импортных электронных компонентов на взаимовыгодных условиях!

Наши преимущества:

- Поставка оригинальных импортных электронных компонентов напрямую с производств Америки, Европы и Азии, а так же с крупнейших складов мира;
- Широкая линейка поставок активных и пассивных импортных электронных компонентов (более 30 млн. наименований);
- Поставка сложных, дефицитных, либо снятых с производства позиций;
- Оперативные сроки поставки под заказ (от 5 рабочих дней);
- Экспресс доставка в любую точку России;
- Помощь Конструкторского Отдела и консультации квалифицированных инженеров;
- Техническая поддержка проекта, помощь в подборе аналогов, поставка прототипов;
- Поставка электронных компонентов под контролем ВП;
- Система менеджмента качества сертифицирована по Международному стандарту ISO 9001;
- При необходимости вся продукция военного и аэрокосмического назначения проходит испытания и сертификацию в лаборатории (по согласованию с заказчиком);
- Поставка специализированных компонентов военного и аэрокосмического уровня качества (Xilinx, Altera, Analog Devices, Intersil, Interpoint, Microsemi, Actel, Aeroflex, Peregrine, VPT, Syfer, Eurofarad, Texas Instruments, MS Kennedy, Miteq, Cobham, E2V, MA-COM, Hittite, Mini-Circuits, General Dynamics и др.);

Компания «Океан Электроники» является официальным дистрибьютором и эксклюзивным представителем в России одного из крупнейших производителей разъемов военного и аэрокосмического назначения «**JONHON**», а так же официальным дистрибьютором и эксклюзивным представителем в России производителя высокотехнологичных и надежных решений для передачи СВЧ сигналов «**FORSTAR**».



JONHON

«**JONHON**» (основан в 1970 г.)

Разъемы специального, военного и аэрокосмического назначения:

(Применяются в военной, авиационной, аэрокосмической, морской, железнодорожной, горно- и нефтедобывающей отраслях промышленности)

«**FORSTAR**» (основан в 1998 г.)

ВЧ соединители, коаксиальные кабели,
кабельные сборки и микроволновые компоненты:

(Применяются в телекоммуникациях гражданского и специального назначения, в средствах связи, РЛС, а так же военной, авиационной и аэрокосмической отраслях промышленности).



Телефон: 8 (812) 309-75-97 (многоканальный)

Факс: 8 (812) 320-03-32

Электронная почта: ocean@oceanchips.ru

Web: <http://oceanchips.ru/>

Адрес: 198099, г. Санкт-Петербург, ул. Калинина, д. 2, корп. 4, лит. А